

Project Details			
<b>Name</b>	Jeanami Silva De Jesus	<b>Date</b>	12/11/2023
<b>Location</b>	211 Old Salem Drive, Spring Lake, NC 28390	<b>Total modules</b>	7
<b>Module</b>	Mission Solar Energy: MSE395SX9R (40mm)	<b>Total watts</b>	2,765
<b>Dimensions</b>	Dimensions: 75.08" x 41.5" x 1.57" (1907.0mm x 1054.0mm x 40.0mm)	<b>Attachments</b>	22
<b>ASCE</b>	7-10	<b>Rails per row</b>	2

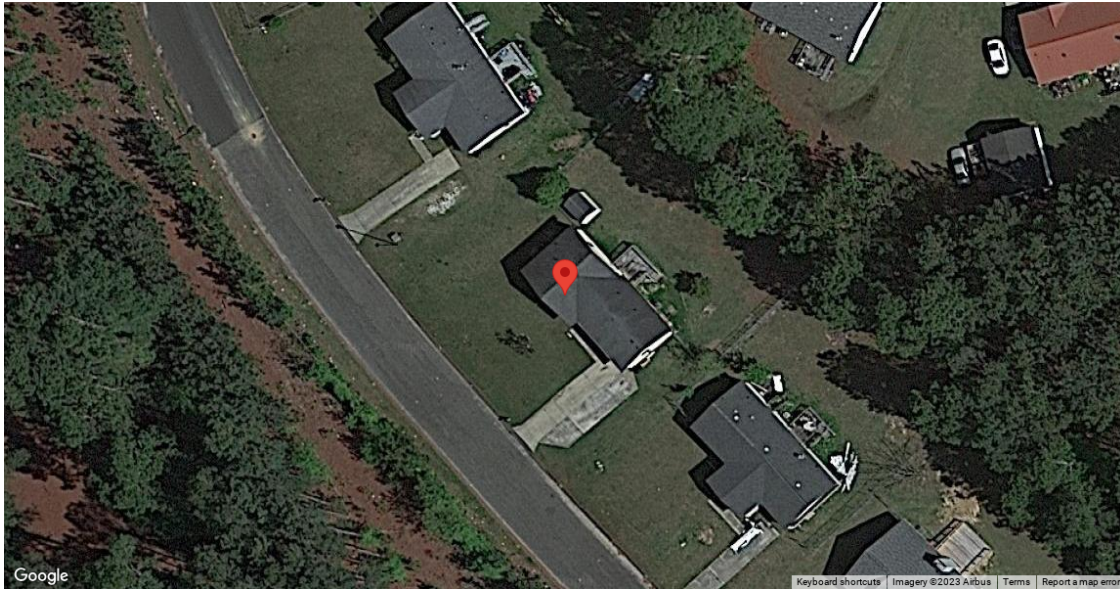

System Weight	
<b>Total system weight</b>	406.8 lbs
<b>Weight/attachment</b>	18.5 lbs
<b>Racking weight</b>	67.3 lbs
<b>Distributed weight</b>	2.6 psf

Load Assumptions	
<b>Wind exposure</b>	B
<b>Wind speed</b>	119 mph
<b>Ground snow load</b>	10 psf
<b>Attachment spacing portrait</b>	6.0'

Roof Information			
<b>Roof Material Family</b>	Comp Shingle	<b>Roof material</b>	Comp Shingle
<b>Risk category</b>	II	<b>Roof attachment</b>	Halo UltraGrip (Rafter attached)
		<b>Staggered attachments</b>	Yes
<b>Attachment hardware</b>	Square		
<b>Specific gravity</b>	0.42		

**Roof Plane A**

<b>Height</b>	15 ft	<b>Slope</b>	23 °	<b>Rafter spacing</b>	24 in
---------------	-------	--------------	------	-----------------------	-------

**Roof Plane A: Roof Section 1**

Details		Weights
Panels: 4	Provided rail: 56' [4 x 168"]	Total weight: 228.5 lbs
Rail orientation: East-West	Attachments: 12	Weight/attachment: 19.0 lbs
Panel orientation: Portrait	Splices: 0	Total Area: 89.0 sq ft
Entry type: Graphical	Clamps: 12	Distributed weight: 2.6 psf

**Diagram**

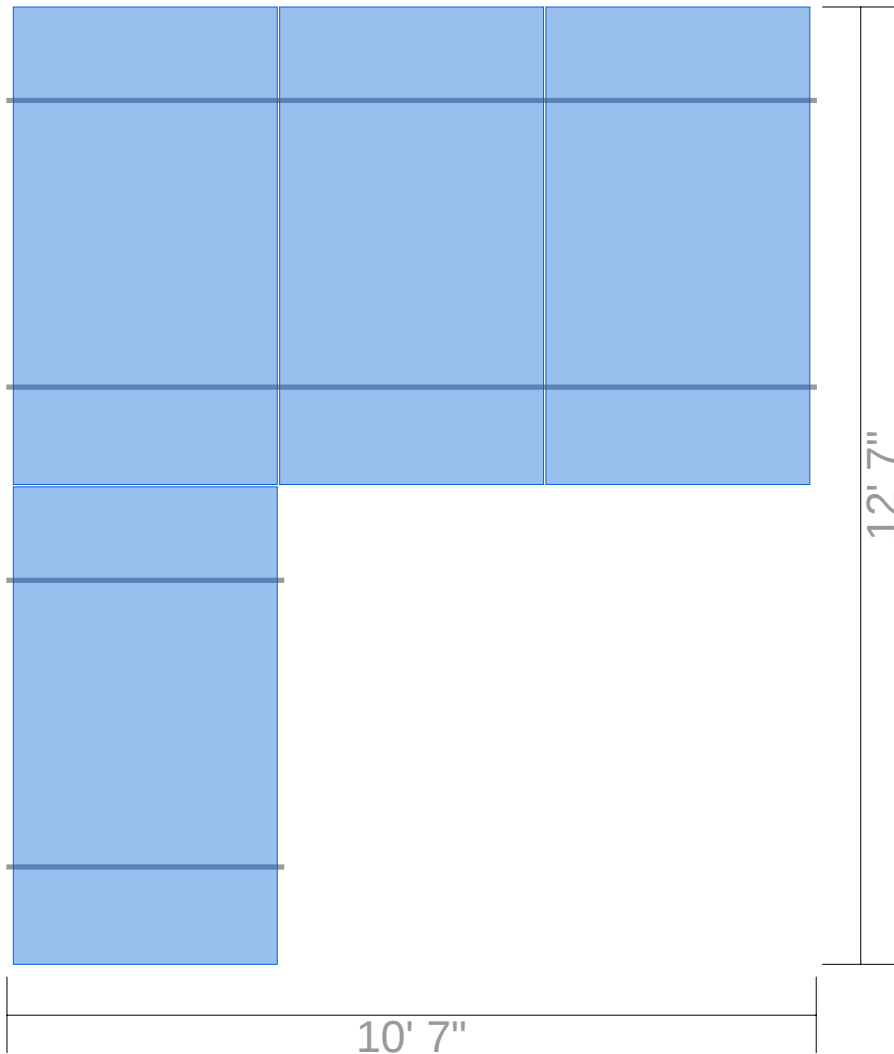

**Segments**

Identifier	Columns	Row length	Rail length	Cantilever	Rail	Attachments	Splices	Clamps
A	3	10' 7"	10' 7"	2' 4" *	28' [2 x 168"]	5	0	8
Cantilever value does not take extra attachments into account								
		<b>Cantilever violations</b>	Fixed with extra attachments					
B	1	3' 8"	3' 8"	0"	28' [2 x 168"]	5	0	4

**Span Details XR10 - Portrait**

Zone	Max span	Max cantilever
1	6' 3"	2' 6"
2	6'	2' 5"
3	<b>4' 10"</b>	1' 11"

**Reaction Forces XR10 - Portrait**

Zone	Uplift (PSF)	Down (lbs)	Uplift (lbs)	Lateral Par (lbs)	Lateral Perp (lbs)
1	11.5	277	182	72	7
2	21.2	277	367	72	7
3	<b>N/A</b>	<b>N/A</b>	<b>N/A</b>	<b>N/A</b>	<b>N/A</b>

**Attachment Span Details Halo UltraGrip (Rafter attached) - Portrait**

Zone	Max attachment span
1	6' 3"
2	6'
3	4' 10"

**\*Optional - Attachment Span Details Halo UltraGrip (Deck attached) - Portrait**

Zone	Max attachment span
1	4' 11"
2	3'
3	1' 11"

\* Based on minimum 7/16" sheathing thickness

**Roof Plane A: Roof Section 2**

Details		Weights
Panels: 2	Provided rail: 28' [2 x 168"]	Total weight: 113.5 lbs
Rail orientation: East-West	Attachments: 5	Weight/attachment: 22.7 lbs
Panel orientation: Portrait	Splices: 0	Total Area: 44.5 sq ft
Entry type: Graphical	Clamps: 6	Distributed weight: 2.6 psf

**Diagram**

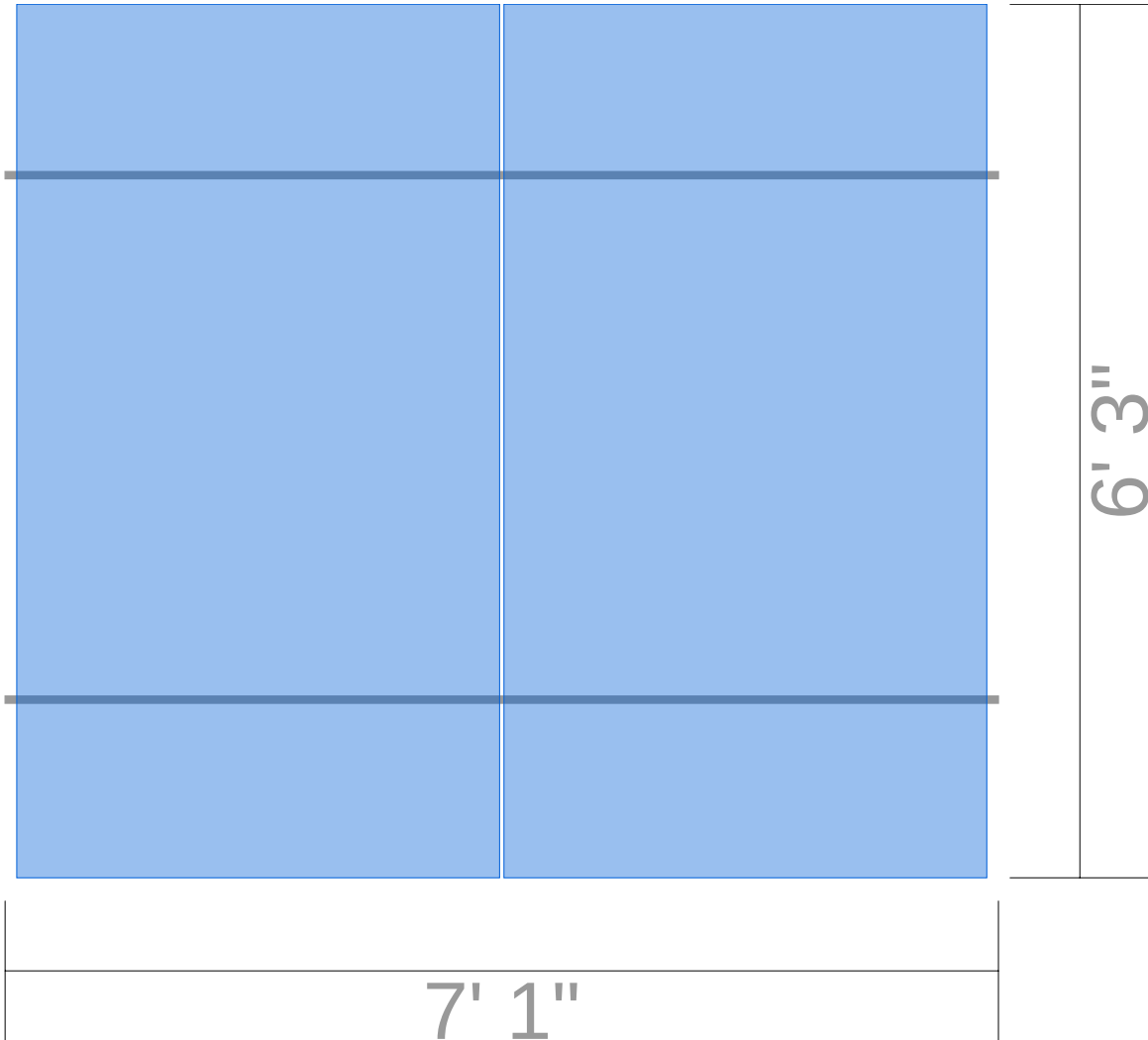

**Segments**

Identifier	Columns	Row length	Rail length	Cantilever	Rail	Attachments	Splices	Clamps
A	2	7' 1"	7' 1"	7"	28' [2 x 168"]	5	0	6

**Span Details XR10 - Portrait**

Zone	Max span	Max cantilever
1	6' 3"	2' 6"
2	6'	2' 5"
3	<b>4' 10"</b>	1' 11"

**Reaction Forces XR10 - Portrait**

Zone	Uplift (PSF)	Down (lbs)	Uplift (lbs)	Lateral Par (lbs)	Lateral Perp (lbs)
1	11.5	277	182	72	7
2	21.2	277	367	72	7
3	<b>N/A</b>	<b>N/A</b>	<b>N/A</b>	<b>N/A</b>	<b>N/A</b>

**Attachment Span Details Halo UltraGrip (Rafter attached) - Portrait**

Zone	Max attachment span
1	6' 3"
2	6'
3	4' 10"

**\*Optional - Attachment Span Details Halo UltraGrip (Deck attached) - Portrait**

Zone	Max attachment span
1	4' 11"
2	3'
3	1' 11"

\* Based on minimum 7/16" sheathing thickness

### Roof Plane A: Roof Section 3

Details		Weights
Panels: 1	Provided rail: 28' [2 x 168"]	Total weight: 64.9 lbs
Rail orientation: East-West	Attachments: 5	Weight/attachment: 13.0 lbs
Panel orientation: Portrait	Splices: 0	Total Area: 22.7 sq ft
Entry type: Graphical	Clamps: 4	Distributed weight: 2.9 psf

## Diagram

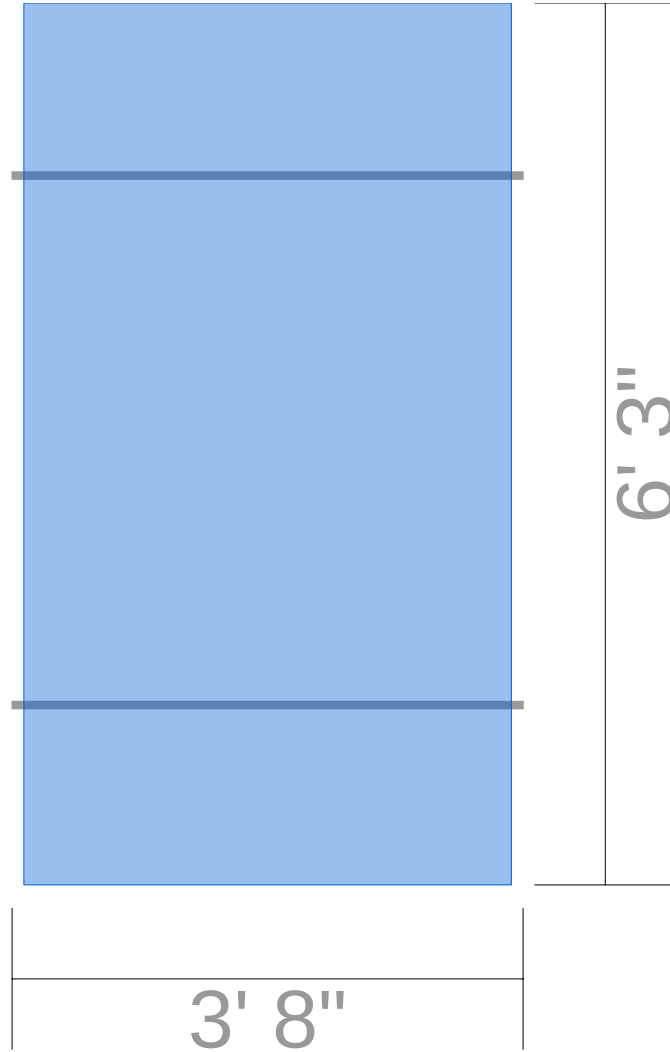

**Segments**

Identifier	Columns	Row length	Rail length	Cantilever	Rail	Attachments	Splices	Clamps
A	1	3' 8"	3' 8"	0"	28' [2 x 168"]	5	0	4

**Span Details XR10 - Portrait**

Zone	Max span	Max cantilever
1	6' 3"	2' 6"
2	6'	2' 5"
3	<b>4' 10"</b>	1' 11"

**Reaction Forces XR10 - Portrait**

Zone	Uplift (PSF)	Down (lbs)	Uplift (lbs)	Lateral Par (lbs)	Lateral Perp (lbs)
1	11.5	277	182	72	7
2	21.2	277	367	72	7
3	<b>N/A</b>	<b>N/A</b>	<b>N/A</b>	<b>N/A</b>	<b>N/A</b>



**Attachment Span Details Halo UltraGrip (Rafter attached) - Portrait**

Zone	Max attachment span
1	6' 3"
2	6'
3	4' 10"

**\*Optional - Attachment Span Details Halo UltraGrip (Deck attached) - Portrait**

Zone	Max attachment span
1	4' 11"
2	3'
3	1' 11"

*\* Based on minimum 7/16" sheathing thickness*

Side View (portrait)

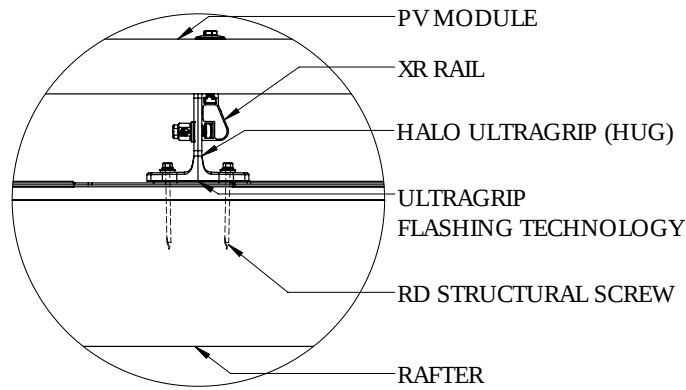
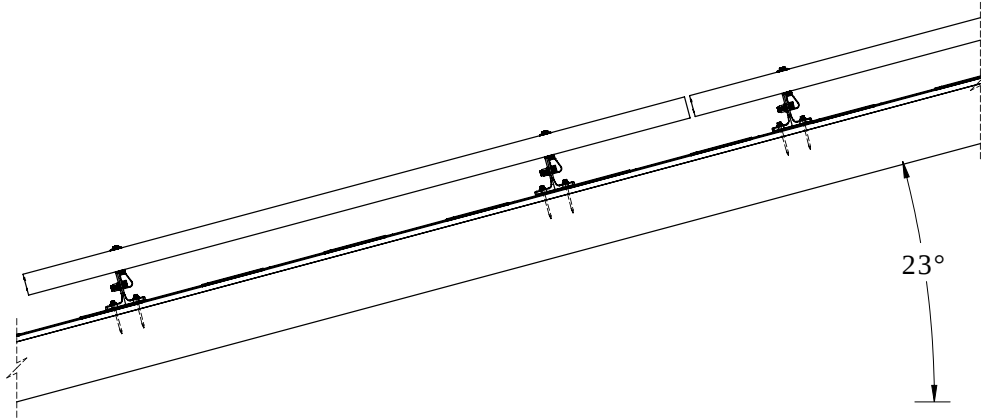

Front View (portrait)

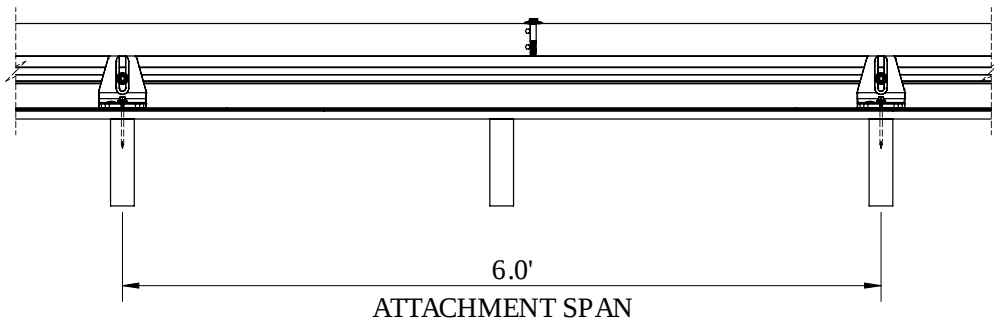

**Front View (portrait)**

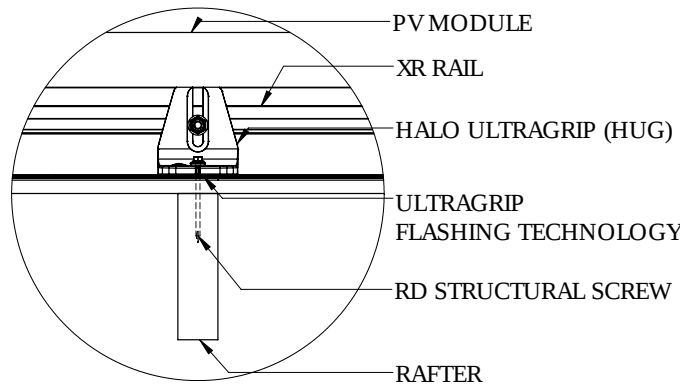

**Splice Details**

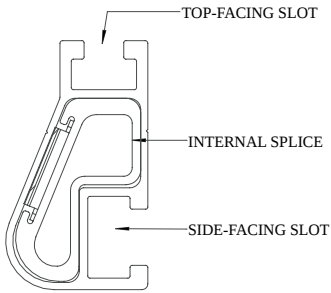

**XR10**

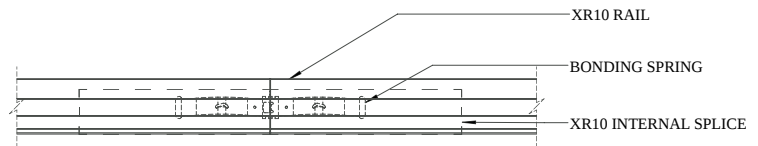

**Splice Connection**

**Clamp Detail**

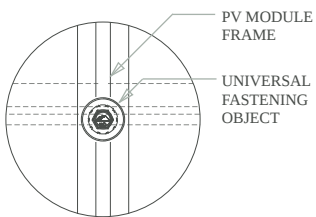

**Mid Clamp, Plan**

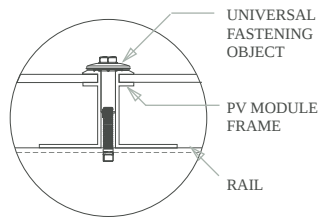

**Mid Clamp, Front**

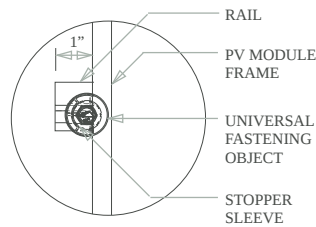

**End Clamp, Plan**

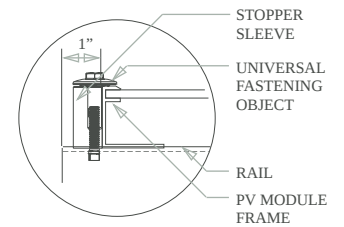

**End Clamp, Front**

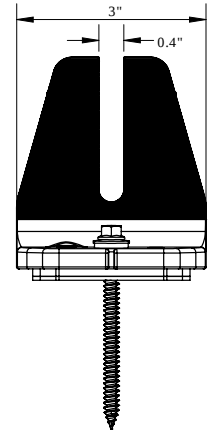
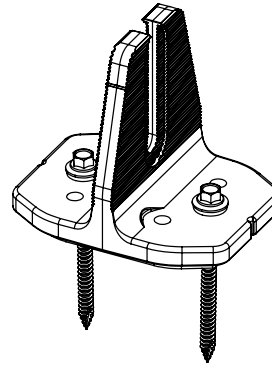
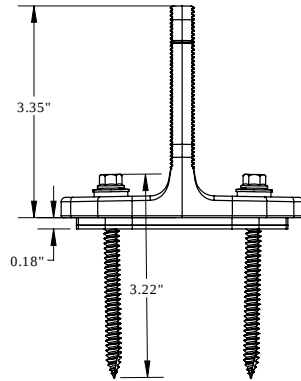
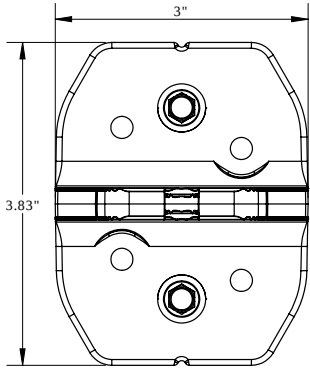

Plan View

Side View

Perspective View

Front View

### Grounding Diagram

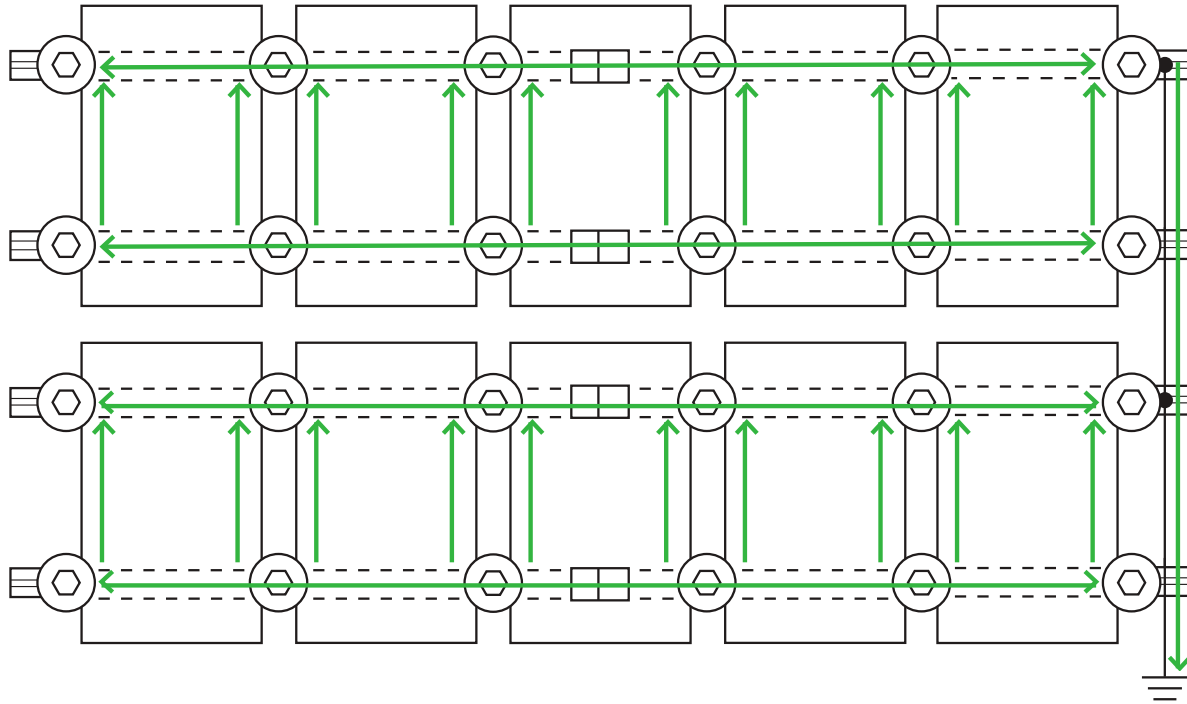

 UFO Clamp

 Fault Current Ground Path

 Grounding Lug \*

 Min 10 AWG Copper Wire \*

 Bonded Splice (Rail Connection)

\* Grounding Lugs and Wire are not required in systems using Enphase microinverters.

**Bill of Materials**

Part	Spares	Total Qty
<b>Rails &amp; Splices</b>		
XR-10-168A XR10, Rail 168" Clear	0	8
<b>Clamps &amp; Grounding</b>		
UFO-CL-01-A1 Universal Module Clamp, Clear	0	22
UFO-STP-40MM-M1 Stopper Sleeve, 40MM, Mill	0	16
XR-LUG-03-A1 Grounding Lug, Low Profile	0	4
<b>Attachments</b>		
QM-HUG-01-M1 Halo UltraGrip, Mill <b>* Includes 2 additional parts to address cantilever violations</b>	0	22
HW-RD1430-01-M1 RD Structural Screw, 3.0L <b>* Includes 2 additional parts to address cantilever violations * Add desired additional screws by adjusting spares column.</b>	0	44
BHW-SQ-02-A1 Square-Bolt Bonding Hardware <b>* Includes 2 additional parts to address cantilever violations</b>	0	22

# ATTACHMENTS

## PRE-INSTALLATION

- Verify module compatibility. See [Page 21](#) for info.

## TOOLS REQUIRED

- |                                 |                       |
|---------------------------------|-----------------------|
| □ Cordless Drill (non-impact)   | □ 3/8" Socket         |
| □ Impact Driver (for lag bolts) | □ 1/8" Drill Bit      |
| □ Torque Wrench (0-250 in-lbs)  | □ 1/4" Drill Bit      |
| □ 7/16" Socket                  | □ T30 Bit             |
| □ 1/2" Socket                   | □ Channel Lock Pliers |
| □ 9/16" Socket                  | □ #3 Phillips Bit     |
| □ 7/32" Drill Bit               | □ 3/16" Hex Bit       |

## BONDING HARDWARE TORQUE VALUES

Please refer to each attachment's individual section for full details on all torque values and instructions.

- 3/8" Bonding Hardware Nuts (7/16" Socket): 250 in-lbs
- All Tile Hook Carriage Bolts (7/16" Socket): 132 in-lbs
- Flat Roof Attachment Nuts (9/16" Socket): 250 in-lbs
- Lynx Set Screw (3/16" Hex Drive): 150 in-lbs
- Lynx Flange Nut (1/2" Socket): 150 in-lbs

➤ If using previous version of Integrated Grounding Mid Clamps, End Clamps, Expansion Joints and for a list of approved 3rd party components please refer to Alternate Components Addendum (Version 1.9)

## ATTACHMENTS

### COMPOSITION SHINGLE



FlashFoot2

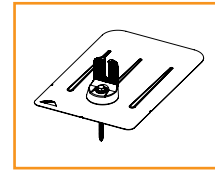

FlashVue

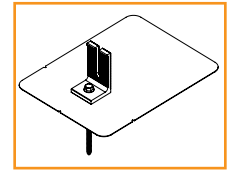

QM L-Mount

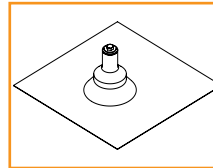

QM QBase

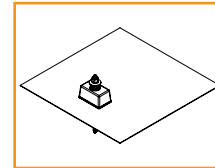

QM Classic Comp Mount

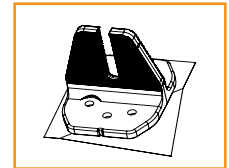

HUG (Halo UltraGrip)

### TILE

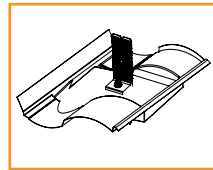

Knockout Tile

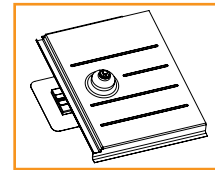

QM Tile Replacement

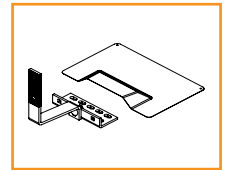

All Tile Hook and Flashing (optional)

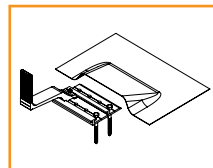

QM Quick Hook and Flashing (optional)

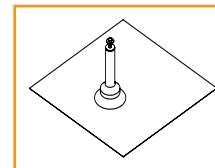

QM QBase Tile

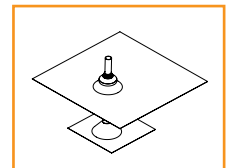

QM Tile Conduit Penetration

### ADDITIONAL ROOF TYPES

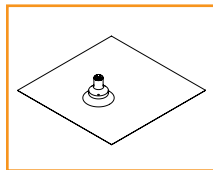

QM Qbase Shake - Slate - Metal Shingle

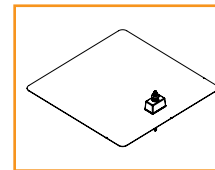

QM Classic Mount Shake

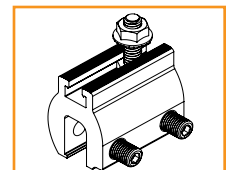

QM Lynx Metal Roof Attachment

### LOW SLOPE ROOF

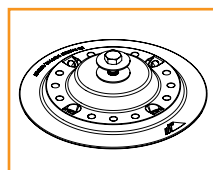

Flat Roof Attachment

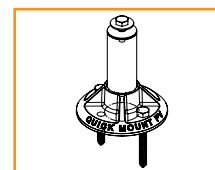

QM QBase Mount

# COMPONENTS

## PRE-INSTALLATION

- Verify module compatibility. See [Page 21](#) for info.

## TOOLS REQUIRED

- Cordless Drill (non-impact)
- Impact Driver (for lag bolts)
- Torque Wrench (0-250 in-lbs)
- 7/16" Socket
- 1/2" Socket
- 9/16" Socket
- 7/32" Drill bit
- 1/8" Drill bit
- 1/4" Drill bit
- T30 Torx Bit
- Channel Lock Pliers
- #3 Phillips Bit
- Paddle Bit

## BONDING HARDWARE TORQUE VALUES

Please refer to each attachment's individual section for full details on all torque values and instructions.

- Universal Fastening Object (7/16" Socket): 80 in-lbs
- Rail Grounding Lug Nut (7/16" Socket): 80 in-lbs
- Module Grounding Lug
  - Grounding Nut (7/16" Socket): 60 in-lbs
  - Grounding Lug Terminal Screws (7/16" Socket): 20 in-lbs
- Microinverter Kit Nuts (7/16" Socket): 80 in-lbs
- Frameless Module Kit Nuts (7/16" Socket): 80 in-lbs
- 3/8" Bonding Hardware Nuts (7/16" Socket): 250 in-lbs
- Contour Clamp (T-30 Torx Bit): 80 in-lbs

➤ Unless otherwise noted, all components have been evaluated for multiple use. They can be uninstalled and reinstalled in the same or new location.

## COMPONENTS

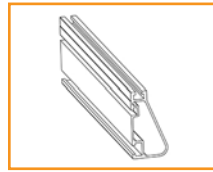

XR Rail



Wire Clip

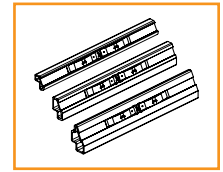

BOSS

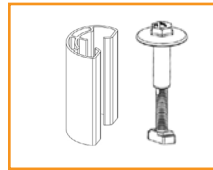

UFO and Stopper Sleeve (30-46MM)



CAMO

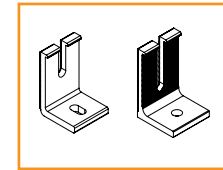

Ironridge L-Foot and QM L-Foot



End Cap

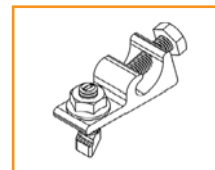

Rail Grounding Lug

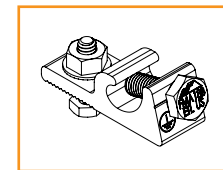

Module Grounding Lug

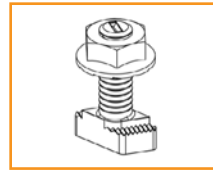

Microinverter Kit

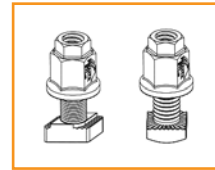

3/8" Bonding Hardware

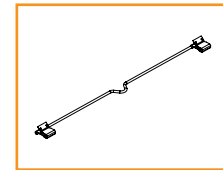

8" Bonding Jumper Single Use Only

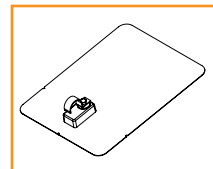

QM Classic Conduit Comp Mount

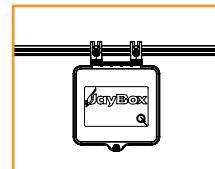

JAYBOX

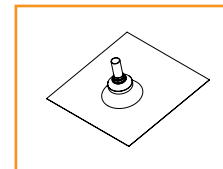

QM Composition Conduit Penetration

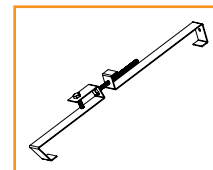

QM Tile Conduit Mount



Frameless End/Mid Clamp

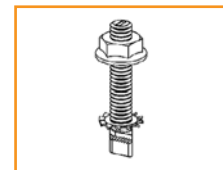

Frameless Module Kit

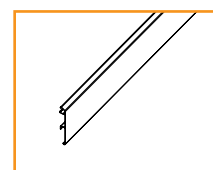

Contour Trim

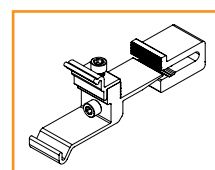

Contour Clamp



**Rail: XR10** Flush Mount System Span Table (inches) - Portrait or Landscape Installation  
 Max Module Length: 78.5", Max Module SF: 24 SF  
 Exposure B

Wind Speed (mph)	Roof Slope (deg.)	Ground Snow: 0 psf			10 psf			20 psf			30 psf			40 psf			50 psf			60 psf			70 psf*			80 psf*			90 psf*			100 psf*			110 psf*			120 psf*		
		Zone 1	Zone 2	Zone 3	Zone 1	Zone 2	Zone 3	Zone 1	Zone 2	Zone 3	Zone 1	Zone 2	Zone 3	Zone 1	Zone 2	Zone 3	Zone 1	Zone 2	Zone 3	Zone 1	Zone 2	Zone 3	Zone 1	Zone 2	Zone 3	Zone 1	Zone 2	Zone 3	Zone 1	Zone 2	Zone 3	Zone 1	Zone 2	Zone 3	Zone 1	Zone 2	Zone 3			
110 mph	8-27	84	75	61	72	72	61	61	61	61	60	60	60	54	54	54	49	49	49	45	45	45	42	42	42	40	40	40	38	38	38	36	36	36	34	34	34	33	33	33
	28-45	84	84	84	72	72	72	60	60	60	60	60	60	55	55	55	52	52	52	49	49	49	48	48	48	43	43	43	41	41	41	39	39	39	37	37	37	36	36	36
115 mph	8-27	84	72	58	72	72	58	61	61	58	60	60	58	54	54	54	49	49	49	45	45	45	42	42	42	40	40	40	38	38	38	36	36	36	34	34	34	33	33	33
	28-45	81	81	81	72	72	72	60	60	60	60	60	60	55	55	55	52	52	52	49	49	49	48	48	48	43	43	43	41	41	41	39	39	39	37	37	37	36	36	36
120 mph	8-27	84	72	56	72	72	56	61	61	56	60	60	56	54	54	54	49	49	49	45	45	45	42	42	42	40	40	40	38	38	38	36	36	36	34	34	34	33	33	33
	28-45	79	78	78	72	72	72	60	60	60	60	60	60	55	55	55	52	52	52	49	49	49	48	48	48	43	43	43	41	41	41	39	39	39	37	37	37	36	36	36
130 mph	8-27	83	64	51	72	64	51	61	61	51	60	60	51	54	54	51	49	49	49	45	45	45	42	42	42	40	40	40	38	38	38	36	36	36	34	34	34	33	33	33
	28-45	75	73	73	72	69	69	60	60	60	60	60	60	55	55	55	52	52	52	49	49	49	48	48	48	43	43	43	41	41	41	39	39	39	37	37	37	36	36	36
140 mph	8-27	81	59	48	72	59	48	61	59	48	60	59	48	54	54	48	49	49	48	45	45	45	42	42	42	40	40	40	38	38	38	36	36	36	34	34	34	33	33	33
	28-45	72	68	68	67	67	67	59	59	59	58	58	58	54	54	54	51	51	51	48	48	48	48	48	48	43	43	43	41	41	41	39	39	39	37	37	37	36	36	36
150 mph	8-27	75	55	44	72	55	44	61	55	44	60	55	44	54	54	44	49	49	44	45	45	44	42	42	42	40	40	40	38	38	38	36	36	36	34	34	34	33	33	33
	28-45	67	64	64	65	64	64	57	57	57	57	57	57	53	53	53	50	50	50	48	48	48	45	45	45	43	43	43	41	41	41	39	39	39	37	37	37	36	36	36
160 mph	8-27	72	52	42	72	52	42	60	52	42	59	52	42	54	52	42	49	49	42	45	45	42	42	42	40	40	40	38	38	38	36	36	36	34	34	34	33	33	33	
	28-45	64	60	60	64	60	60	56	56	56	55	55	55	52	52	52	49	49	49	48	48	48	44	44	44	42	42	42	41	41	41	39	39	39	37	37	37	36	36	36
170 mph	8-27	67	48	39	67	48	39	59	48	39	58	48	39	53	48	39	49	48	39	45	45	39	42	42	39	40	40	39	38	38	38	36	36	36	34	34	34	33	33	33
	28-45	61	56	56	60	56	56	54	54	54	53	53	53	50	50	50	48	48	48	45	45	45	43	43	43	42	42	42	40	40	40	39	39	39	37	37	37	36	36	36
180 mph	8-27	64	48	37	64	48	37	58	48	37	57	48	37	52	48	37	49	48	37	45	45	37	42	42	37	40	40	37	38	38	37	36	36	36	34	34	34	33	33	33
	28-45	58	53	53	58	53	53	52	52	52	52	52	52	49	49	49	48	48	48	44	44	44	43	43	43	41	41	41	40	40	40	38	38	38	37	37	37	36	36	36

= min 72" span     
  = min 64" span     
  = min 48" span     
 \* = Note: additional installation requirement for CAMO module clamp. See Note 12 on Page 3 for details.     
 REV 03/05/2021

= Shaded cells indicate conditions in which UFO Mid Clamp connection capacity is exceeded. See Note 10 on page 2 for details.