

Project Details			
Name	MARIA T FLORES ZARATE	Date	12/06/2023
Location	36 Stone Wood Lane, Sanford, NC 27332	Total modules	9
Module	Mission Solar Energy: MSE395SX9R (40mm)	Total watts	3,555
Dimensions	Dimensions: 75.08" x 41.5" x 1.57" (1907.0mm x 1054.0mm x 40.0mm)	Attachments	29
ASCE	7-10	Rails per row	2

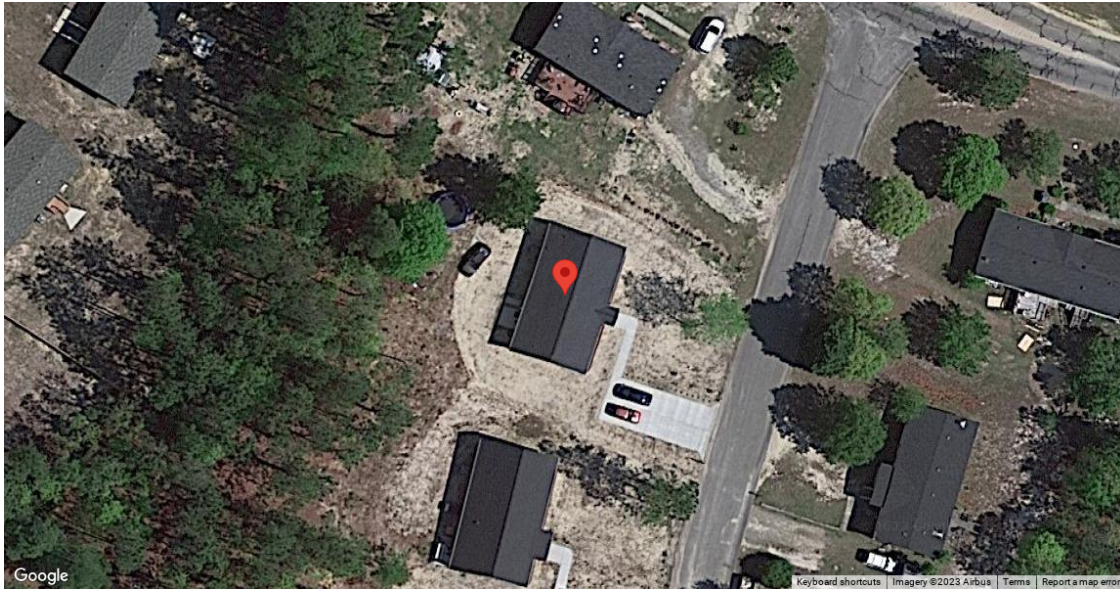

System Weight	
Total system weight	534.7 lbs
Weight/attachment	18.4 lbs
Racking weight	98.2 lbs
Distributed weight	2.7 psf

Load Assumptions	
Wind exposure	B
Wind speed	120 mph
Ground snow load	15 psf
Attachment spacing portrait	4.0'

Roof Information			
Roof Material Family	Comp Shingle	Roof material	Comp Shingle
Risk category	II	Roof attachment	Halo UltraGrip (Rafter attached)
		Staggered attachments	Yes
Attachment hardware	Square		
Specific gravity	0.42		

Roof Plane A

Height	15 ft	Slope	26 °	Rafter spacing	24 in
---------------	-------	--------------	------	-----------------------	-------

Roof Plane A: Roof Section 1

Details		Weights
Panels: 4	Provided rail: 56' [4 x 168"]	Total weight: 226.6 lbs
Rail orientation: East-West	Attachments: 9	Weight/attachment: 25.2 lbs
Panel orientation: Portrait	Splices: 2	Total Area: 88.2 sq ft
Entry type: Graphical	Clamps: 10	Distributed weight: 2.6 psf

Diagram

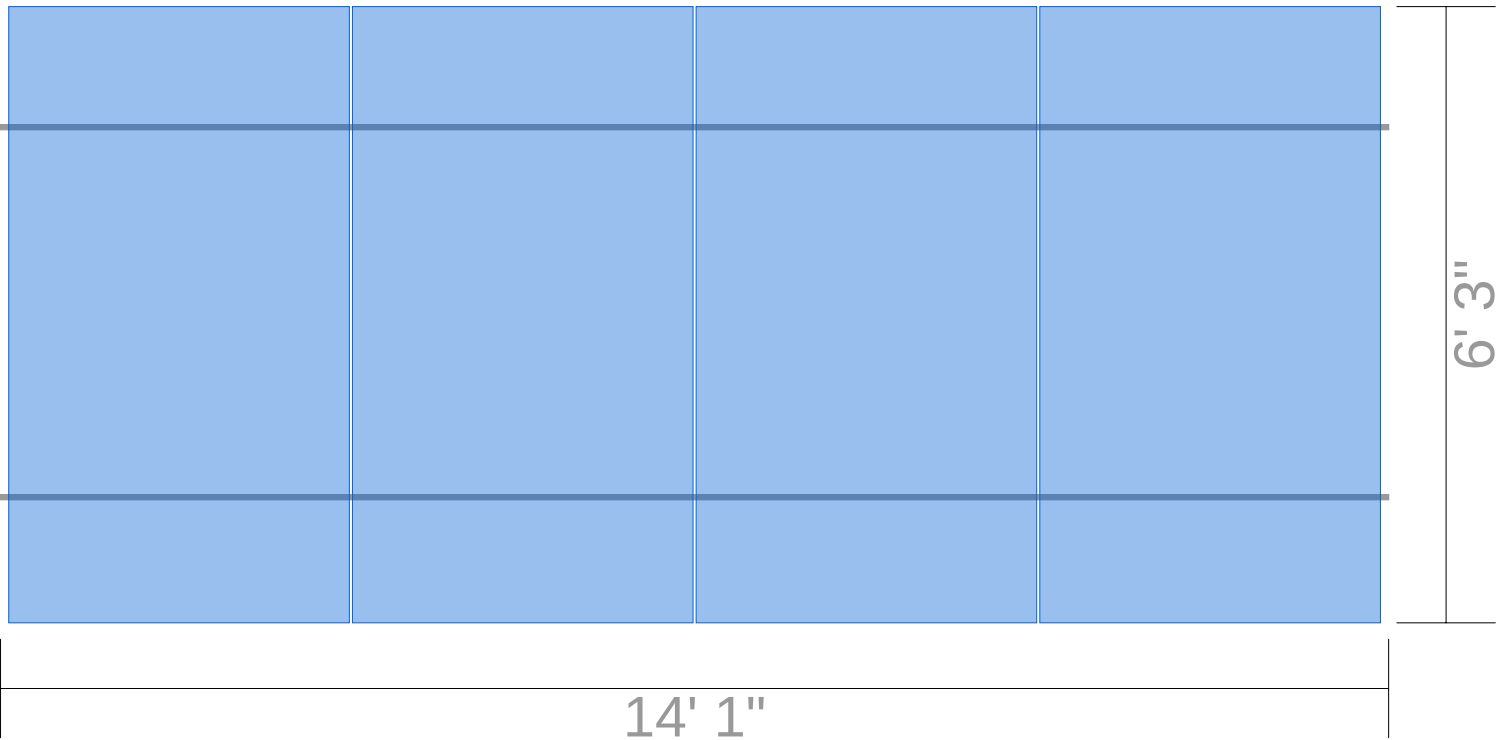

Segments

Identifier	Columns	Row length	Rail length	Cantilever	Rail	Attachments	Splices	Clamps
A	4	14' 1"	14' 1"	1' 1"	56' [4 x 168"]	9	2	10

Span Details XR10 - Portrait

Zone	Max span	Max cantilever
1	5' 11"	2' 4"
2	5' 11"	2' 4"
3	4' 9"	1' 11"

Reaction Forces XR10 - Portrait

Zone	Uplift (PSF)	Down (lbs)	Uplift (lbs)	Lateral Par (lbs)	Lateral Perp (lbs)
1	11.7	203	125	67	4
2	21.5	203	255	67	4
3	33.2	203	403	67	4

Attachment Span Details Halo UltraGrip (Rafter attached) - Portrait

Zone	Max attachment span
1	5' 11"
2	5' 11"
3	4' 9"

***Optional - Attachment Span Details Halo UltraGrip (Deck attached) - Portrait**

Zone	Max attachment span
1	4' 6"
2	3'
3	1' 10"

* Based on minimum 7/16" sheathing thickness

Roof Plane A: Roof Section 2

Details		Weights
Panels: 3	Provided rail: 56' [4 x 168"]	Total weight: 178.4 lbs
Rail orientation: East-West	Attachments: 10	Weight/attachment: 17.8 lbs
Panel orientation: Portrait	Splices: 0	Total Area: 67.2 sq ft
Entry type: Graphical	Clamps: 10	Distributed weight: 2.7 psf

Diagram

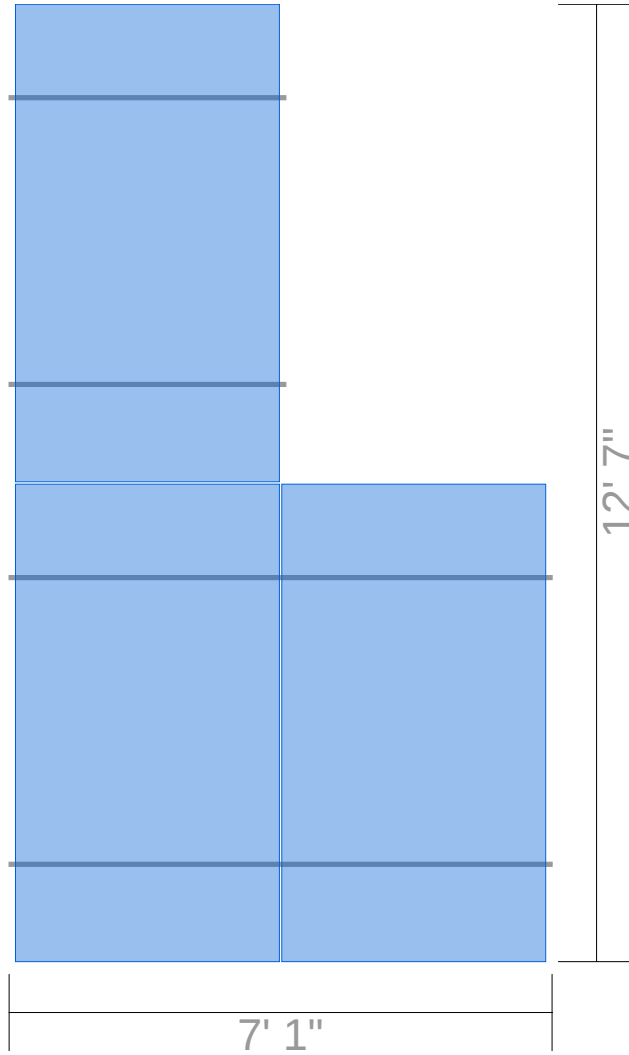

Segments

Identifier	Columns	Row length	Rail length	Cantilever	Rail	Attachments	Splices	Clamps
A	1	3' 8"	3' 8"	0"	28' [2 x 168"]	5	0	4
B	2	7' 1"	7' 1"	1' 7"	28' [2 x 168"]	5	0	6

Span Details XR10 - Portrait

Zone	Max span	Max cantilever
1	5' 11"	2' 4"
2	5' 11"	2' 4"
3	4' 9"	1' 11"

Reaction Forces XR10 - Portrait

Zone	Uplift (PSF)	Down (lbs)	Uplift (lbs)	Lateral Par (lbs)	Lateral Perp (lbs)
1	11.7	203	125	67	4
2	21.5	203	255	67	4
3	33.2	203	403	67	4

Attachment Span Details Halo UltraGrip (Rafter attached) - Portrait

Zone	Max attachment span
1	5' 11"
2	5' 11"
3	4' 9"

***Optional - Attachment Span Details Halo UltraGrip (Deck attached) - Portrait**

Zone	Max attachment span
1	4' 6"
2	3'
3	1' 10"

* Based on minimum 7/16" sheathing thickness

Roof Plane A: Roof Section 3

Details		Weights
Panels: 1	Provided rail: 28' [2 x 168"]	Total weight: 64.9 lbs
Rail orientation: East-West	Attachments: 5	Weight/attachment: 13.0 lbs
Panel orientation: Portrait	Splices: 0	Total Area: 22.7 sq ft
Entry type: Graphical	Clamps: 4	Distributed weight: 2.9 psf

Diagram

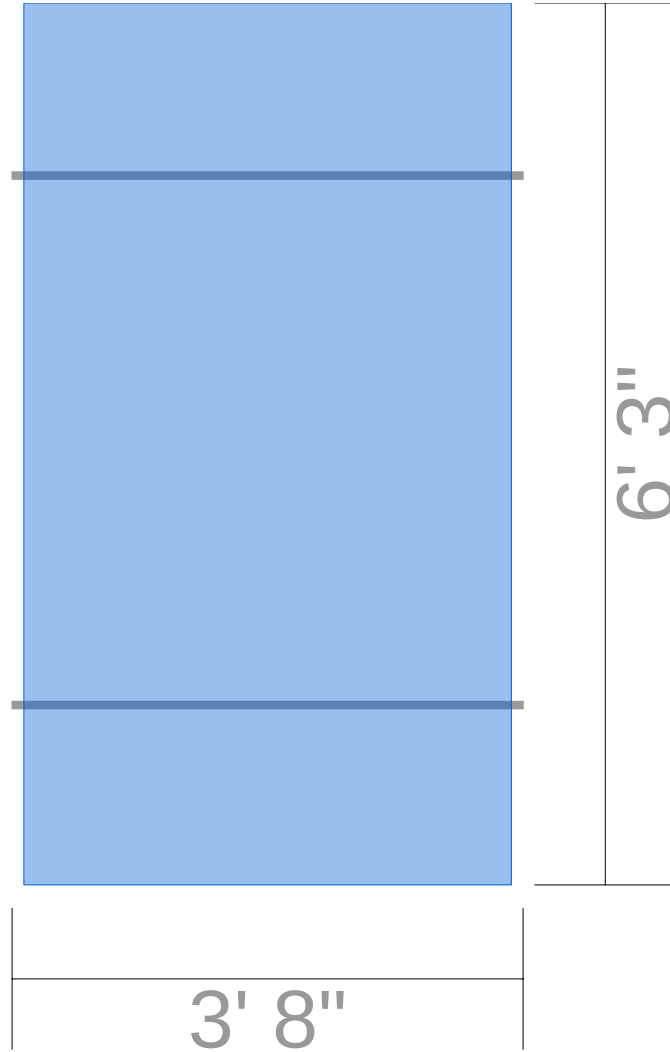

Segments

Identifier	Columns	Row length	Rail length	Cantilever	Rail	Attachments	Splices	Clamps
A	1	3' 8"	3' 8"	0"	28' [2 x 168"]	5	0	4

Span Details XR10 - Portrait

Zone	Max span	Max cantilever
1	5' 11"	2' 4"
2	5' 11"	2' 4"
3	4' 9"	1' 11"

Reaction Forces XR10 - Portrait

Zone	Uplift (PSF)	Down (lbs)	Uplift (lbs)	Lateral Par (lbs)	Lateral Perp (lbs)
1	11.7	203	125	67	4
2	21.5	203	255	67	4
3	33.2	203	403	67	4

Attachment Span Details Halo UltraGrip (Rafter attached) - Portrait

Zone	Max attachment span
1	5' 11"
2	5' 11"
3	4' 9"

***Optional - Attachment Span Details Halo UltraGrip (Deck attached) - Portrait**

Zone	Max attachment span
1	4' 6"
2	3'
3	1' 10"

* Based on minimum 7/16" sheathing thickness

Roof Plane A: Roof Section 4

Details		Weights
Panels: 1	Provided rail: 28' [2 x 168"]	Total weight: 64.9 lbs
Rail orientation: East-West	Attachments: 5	Weight/attachment: 13.0 lbs
Panel orientation: Portrait	Splices: 0	Total Area: 22.7 sq ft
Entry type: Graphical	Clamps: 4	Distributed weight: 2.9 psf

Diagram

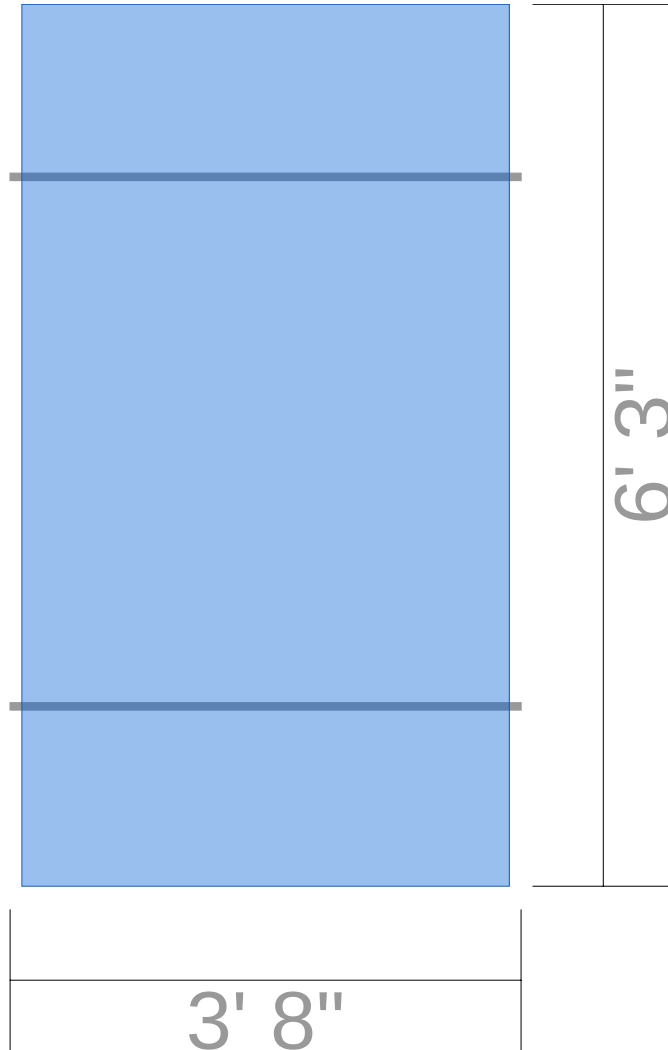

Segments

Identifier	Columns	Row length	Rail length	Cantilever	Rail	Attachments	Splices	Clamps
A	1	3' 8"	3' 8"	0"	28' [2 x 168"]	5	0	4

Span Details XR10 - Portrait

Zone	Max span	Max cantilever
1	5' 11"	2' 4"
2	5' 11"	2' 4"
3	4' 9"	1' 11"

Reaction Forces XR10 - Portrait

Zone	Uplift (PSF)	Down (lbs)	Uplift (lbs)	Lateral Par (lbs)	Lateral Perp (lbs)
1	11.7	203	125	67	4
2	21.5	203	255	67	4
3	33.2	203	403	67	4

Attachment Span Details Halo UltraGrip (Rafter attached) - Portrait

Zone	Max attachment span
1	5' 11"
2	5' 11"
3	4' 9"

***Optional - Attachment Span Details Halo UltraGrip (Deck attached) - Portrait**

Zone	Max attachment span
1	4' 6"
2	3'
3	1' 10"

* Based on minimum 7/16" sheathing thickness

Side View (portrait)

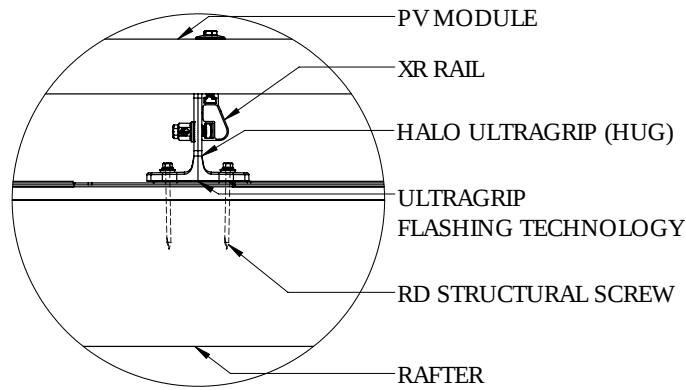
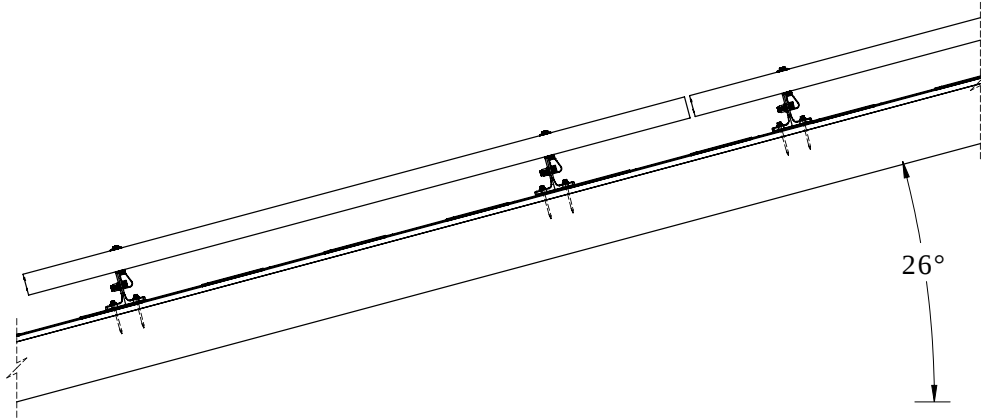

Front View (portrait)

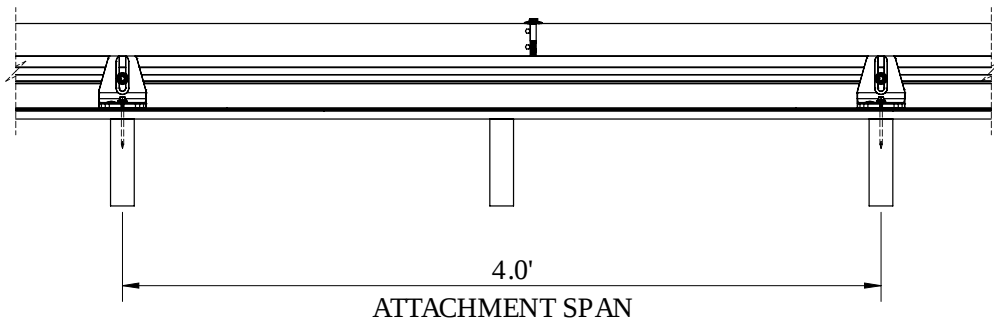

Front View (portrait)

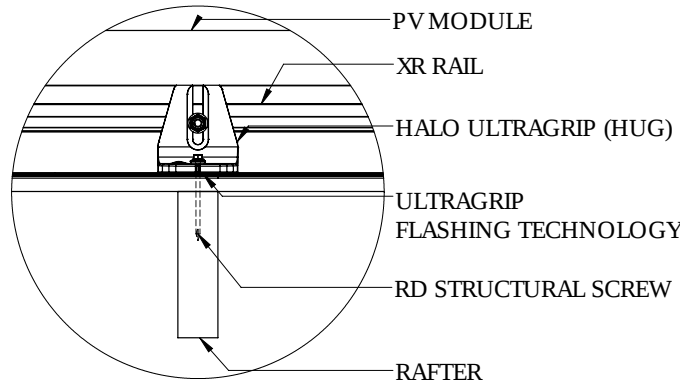

Splice Details

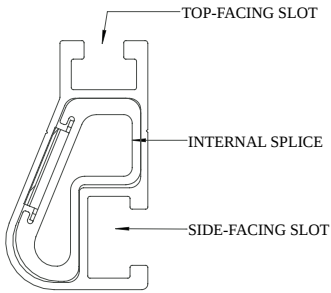

XR10

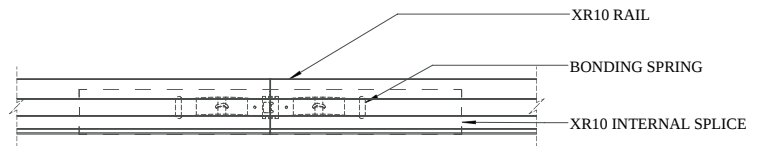

Splice Connection

Clamp Detail

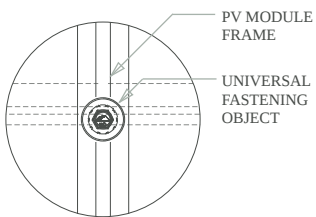

Mid Clamp, Plan

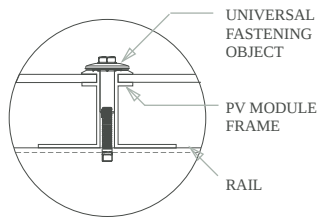

Mid Clamp, Front

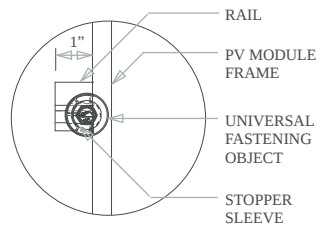

End Clamp, Plan

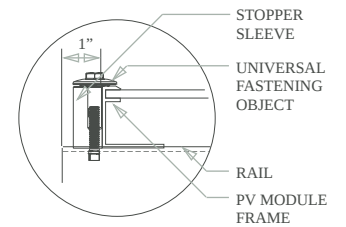

End Clamp, Front

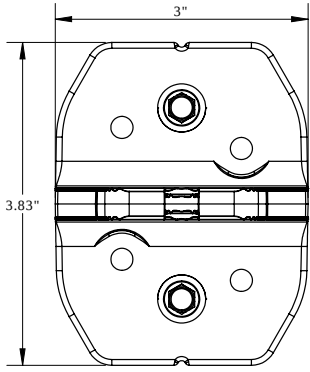

Plan View

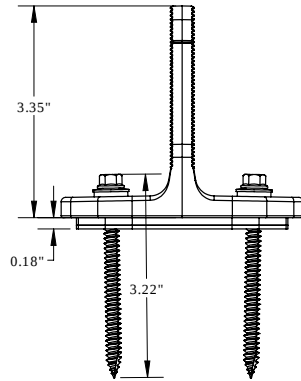

Side View

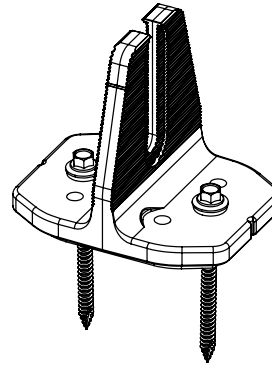

Perspective View

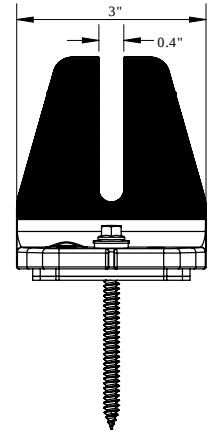

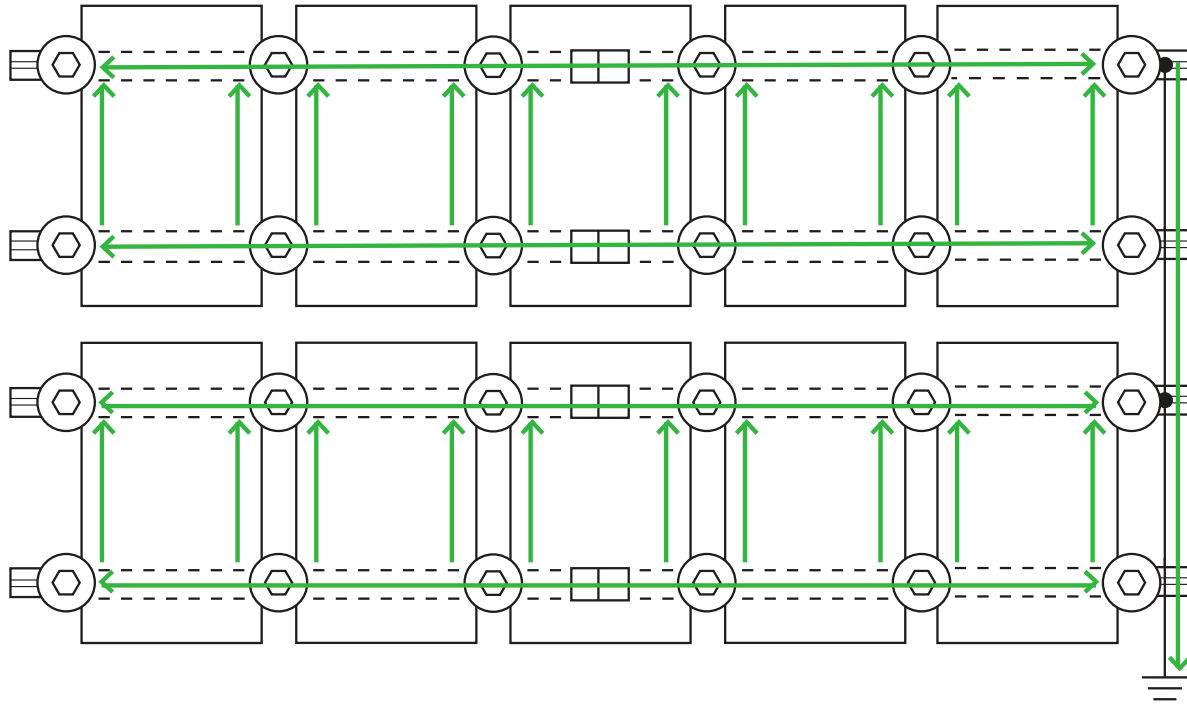

Front View

Grounding Diagram



 UFO Clamp

 Fault Current Ground Path

 Grounding Lug *

 Min 10 AWG Copper Wire *

 Bonded Splice (Rail Connection)

* Grounding Lugs and Wire are not required in systems using Enphase microinverters.

Bill of Materials

Part	Spares	Total Qty
------	--------	-----------

Rails & Splices

XR-10-168A XR10, Rail 168" Clear	0	12
-------------------------------------	---	----

XR10-BOSS-01-M1 Bonded Splice, XR10	0	2
--	---	---

Clamps & Grounding

UFO-CL-01-A1 Universal Module Clamp, Clear	0	28
---	---	----

UFO-STP-40MM-M1 Stopper Sleeve, 40MM, Mill	0	20
---	---	----

XR-LUG-03-A1 Grounding Lug, Low Profile	0	5
--	---	---

Attachments

QM-HUG-01-M1 Halo UltraGrip, Mill	0	29
--------------------------------------	---	----

HW-RD1430-01-M1 RD Structural Screw, 3.0L * Add desired additional screws by adjusting spares column.	0	58
--	---	----

BHW-SQ-02-A1 Square-Bolt Bonding Hardware	0	29
--	---	----

ATTACHMENTS

PRE-INSTALLATION

- Verify module compatibility. See [Page 21](#) for info.

TOOLS REQUIRED

- | | |
|---------------------------------|-----------------------|
| □ Cordless Drill (non-impact) | □ 3/8" Socket |
| □ Impact Driver (for lag bolts) | □ 1/8" Drill Bit |
| □ Torque Wrench (0-250 in-lbs) | □ 1/4" Drill Bit |
| □ 7/16" Socket | □ T30 Bit |
| □ 1/2" Socket | □ Channel Lock Pliers |
| □ 9/16" Socket | □ #3 Phillips Bit |
| □ 7/32" Drill Bit | □ 3/16" Hex Bit |

BONDING HARDWARE TORQUE VALUES

Please refer to each attachment's individual section for full details on all torque values and instructions.

- 3/8" Bonding Hardware Nuts (7/16" Socket): 250 in-lbs
- All Tile Hook Carriage Bolts (7/16" Socket): 132 in-lbs
- Flat Roof Attachment Nuts (9/16" Socket): 250 in-lbs
- Lynx Set Screw (3/16" Hex Drive): 150 in-lbs
- Lynx Flange Nut (1/2" Socket): 150 in-lbs

➤ If using previous version of Integrated Grounding Mid Clamps, End Clamps, Expansion Joints and for a list of approved 3rd party components please refer to Alternate Components Addendum (Version 1.9)

ATTACHMENTS

COMPOSITION SHINGLE



FlashFoot2

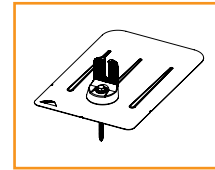

FlashVue

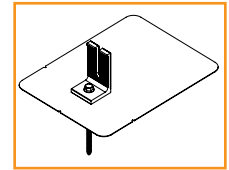

QM L-Mount

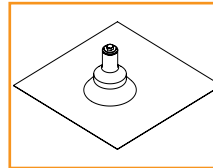

QM QBase

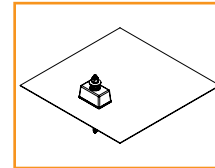

QM Classic Comp Mount

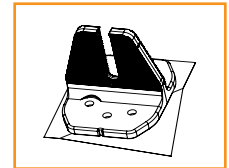

HUG (Halo UltraGrip)

TILE

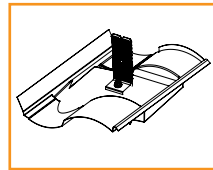

Knockout Tile

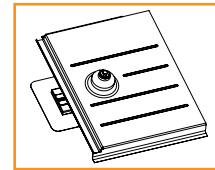

QM Tile Replacement

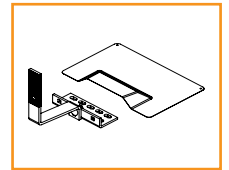

All Tile Hook and Flashing (optional)

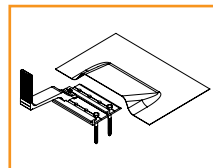

QM Quick Hook and Flashing (optional)

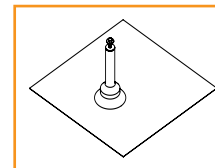

QM QBase Tile

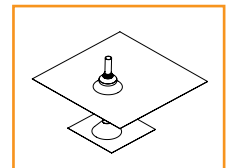

QM Tile Conduit Penetration

ADDITIONAL ROOF TYPES

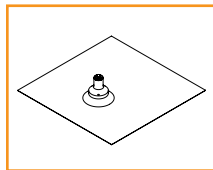

QM Qbase Shake - Slate - Metal Shingle

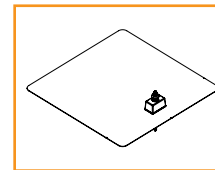

QM Classic Mount Shake

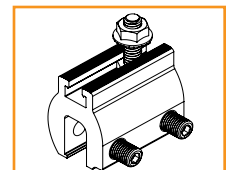

QM Lynx Metal Roof Attachment

LOW SLOPE ROOF

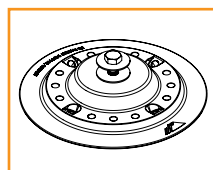

Flat Roof Attachment

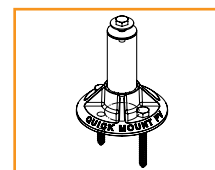

QM QBase Mount

COMPONENTS

PRE-INSTALLATION

- Verify module compatibility. See [Page 21](#) for info.

TOOLS REQUIRED

- Cordless Drill (non-impact)
- Impact Driver (for lag bolts)
- Torque Wrench (0-250 in-lbs)
- 7/16" Socket
- 1/2" Socket
- 9/16" Socket
- 7/32" Drill bit
- 1/8" Drill bit
- 1/4" Drill bit
- T30 Torx Bit
- Channel Lock Pliers
- #3 Phillips Bit
- Paddle Bit

BONDING HARDWARE TORQUE VALUES

Please refer to each attachment's individual section for full details on all torque values and instructions.

- Universal Fastening Object (7/16" Socket): 80 in-lbs
- Rail Grounding Lug Nut (7/16" Socket): 80 in-lbs
- Module Grounding Lug
 - Grounding Nut (7/16" Socket): 60 in-lbs
 - Grounding Lug Terminal Screws (7/16" Socket): 20 in-lbs
- Microinverter Kit Nuts (7/16" Socket): 80 in-lbs
- Frameless Module Kit Nuts (7/16" Socket): 80 in-lbs
- 3/8" Bonding Hardware Nuts (7/16" Socket): 250 in-lbs
- Contour Clamp (T-30 Torx Bit): 80 in-lbs

➤ Unless otherwise noted, all components have been evaluated for multiple use. They can be uninstalled and reinstalled in the same or new location.

COMPONENTS

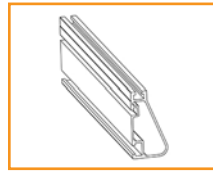

XR Rail



Wire Clip

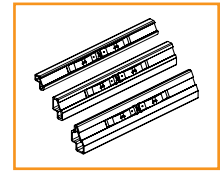

BOSS

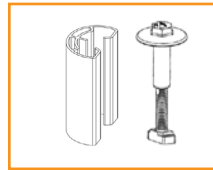

UFO and Stopper Sleeve (30-46MM)



CAMO

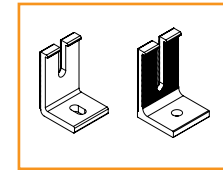

Ironridge L-Foot and QM L-Foot



End Cap

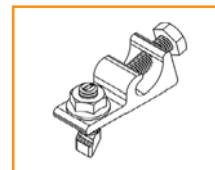

Rail Grounding Lug

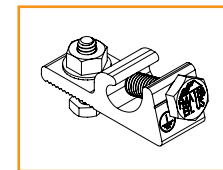

Module Grounding Lug

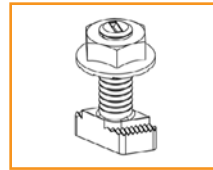

Microinverter Kit

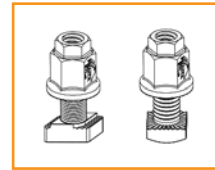

3/8" Bonding Hardware

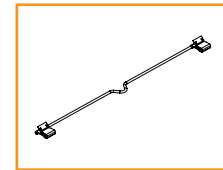

8" Bonding Jumper Single Use Only

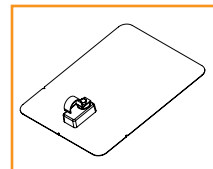

QM Classic Conduit Comp Mount

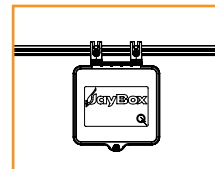

JAYBOX

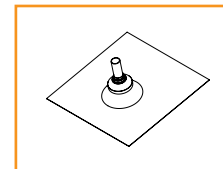

QM Composition Conduit Penetration

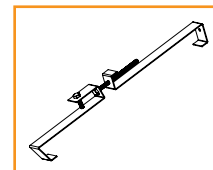

QM Tile Conduit Mount



Frameless End/Mid Clamp

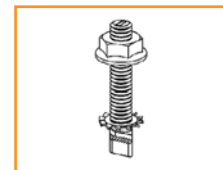

Frameless Module Kit

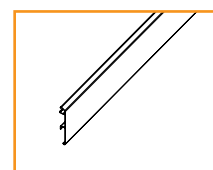

Contour Trim

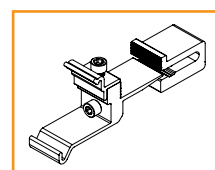

Contour Clamp

Rail: XR10 Flush Mount System Span Table (inches) - Portrait or Landscape Installation
 Max Module Length: 78.5", Max Module SF: 24 SF
 Exposure B

Wind Speed (mph)	Roof Slope (deg.)	Ground Snow: 0 psf			10 psf			20 psf			30 psf			40 psf			50 psf			60 psf			70 psf*			80 psf*			90 psf*			100 psf*			110 psf*			120 psf*		
		Zone 1	Zone 2	Zone 3	Zone 1	Zone 2	Zone 3	Zone 1	Zone 2	Zone 3	Zone 1	Zone 2	Zone 3	Zone 1	Zone 2	Zone 3	Zone 1	Zone 2	Zone 3	Zone 1	Zone 2	Zone 3	Zone 1	Zone 2	Zone 3	Zone 1	Zone 2	Zone 3	Zone 1	Zone 2	Zone 3	Zone 1	Zone 2	Zone 3	Zone 1	Zone 2	Zone 3			
110 mph	8-27	84	75	61	72	72	61	61	61	61	60	60	60	54	54	54	49	49	49	45	45	45	42	42	42	40	40	40	38	38	38	36	36	36	34	34	34	33	33	33
	28-45	84	84	84	72	72	72	60	60	60	60	60	60	55	55	55	52	52	52	49	49	49	48	48	48	43	43	43	41	41	41	39	39	39	37	37	37	36	36	36
115 mph	8-27	84	72	58	72	72	58	61	61	58	60	60	58	54	54	54	49	49	49	45	45	45	42	42	42	40	40	40	38	38	38	36	36	36	34	34	34	33	33	33
	28-45	81	81	81	72	72	72	60	60	60	60	60	60	55	55	55	52	52	52	49	49	49	48	48	48	43	43	43	41	41	41	39	39	39	37	37	37	36	36	36
120 mph	8-27	84	72	56	72	72	56	61	61	56	60	60	56	54	54	54	49	49	49	45	45	45	42	42	42	40	40	40	38	38	38	36	36	36	34	34	34	33	33	33
	28-45	79	78	78	72	72	72	60	60	60	60	60	60	55	55	55	52	52	52	49	49	49	48	48	48	43	43	43	41	41	41	39	39	39	37	37	37	36	36	36
130 mph	8-27	83	64	51	72	64	51	61	61	51	60	60	51	54	54	51	49	49	49	45	45	45	42	42	42	40	40	40	38	38	38	36	36	36	34	34	34	33	33	33
	28-45	75	73	73	72	69	69	60	60	60	60	60	60	55	55	55	52	52	52	49	49	49	48	48	48	43	43	43	41	41	41	39	39	39	37	37	37	36	36	36
140 mph	8-27	81	59	48	72	59	48	61	59	48	60	59	48	54	54	48	49	49	48	45	45	45	42	42	42	40	40	40	38	38	38	36	36	36	34	34	34	33	33	33
	28-45	72	68	68	67	67	67	59	59	59	58	58	58	54	54	54	51	51	51	48	48	48	48	48	48	43	43	43	41	41	41	39	39	39	37	37	37	36	36	36
150 mph	8-27	75	55	44	72	55	44	61	55	44	60	55	44	54	54	44	49	49	44	45	45	44	42	42	42	40	40	40	38	38	38	36	36	36	34	34	34	33	33	33
	28-45	67	64	64	65	64	64	57	57	57	57	57	57	53	53	53	50	50	50	48	48	48	45	45	45	43	43	43	41	41	41	39	39	39	37	37	37	36	36	36
160 mph	8-27	72	52	42	72	52	42	60	52	42	59	52	42	54	52	42	49	49	42	45	45	42	42	42	40	40	40	38	38	38	36	36	36	34	34	34	33	33	33	
	28-45	64	60	60	64	60	60	56	56	56	55	55	55	52	52	52	49	49	49	48	48	48	44	44	44	42	42	42	41	41	41	39	39	39	37	37	37	36	36	36
170 mph	8-27	67	48	39	67	48	39	59	48	39	58	48	39	53	48	39	49	48	39	45	45	39	42	42	39	40	40	39	38	38	38	36	36	36	34	34	34	33	33	33
	28-45	61	56	56	60	56	56	54	54	54	53	53	53	50	50	50	48	48	48	45	45	45	43	43	43	42	42	42	40	40	40	39	39	39	37	37	37	36	36	36
180 mph	8-27	64	48	37	64	48	37	58	48	37	57	48	37	52	48	37	49	48	37	45	45	37	42	42	37	40	40	37	38	38	37	36	36	36	34	34	34	33	33	33
	28-45	58	53	53	58	53	53	52	52	52	52	52	52	49	49	49	48	48	48	44	44	44	43	43	43	41	41	41	40	40	40	38	38	38	37	37	37	36	36	36

= min 72" span
 = min 64" span
 = min 48" span
 * = Note: additional installation requirement for CAMO module clamp. See Note 12 on Page 3 for details.
 REV 03/05/2021
 = Shaded cells indicate conditions in which UFO Mid Clamp connection capacity is exceeded. See Note 10 on page 2 for details.