

Lucent Engineering, P.C.

814 E 1475 N

Lehi, UT 84043

m: (309) 645-0999

admin@lucenteng.co

October 26, 2023

Encōr Solar, LLC
2392 N Orchard Way
Saratoga Springs, UT 84045

RE: Engineering Services
Case Residence
115 Taplow Trail, Cameron, NC
7.54 kW System
Solo Job #4106640

To Whom It May Concern,

We have reviewed the following information regarding the solar panel installation for this project. Alterations to these documents or plans shall not be made without direct written consent of the Engineer of Record.

A. Assumptions from Field Observation provided by Encōr Solar, LLC

The following structural design regarding the proposed alterations have been prepared from these assumptions. The verification of the field observations is the responsibility of the contractor. **Prior to commencement of work, the contractor shall verify the framing sizes, spacings, and spans noted in the sealed plans, calculations, and/or certification letter and notify the Engineer of Record of any discrepancies.**

	<u>Roof</u>
Roof Finish :	Asphalt Shingle
Roof Underlayment :	OSB
Roof Profile :	Gable
Roof Structural System :	Rafter w/ Various Support
Truss Top Chord/Setup :	2 x 6 / King
Chord/Rafter Wood Grade :	Southern Pine #2 or better
Truss/Rafter Spacing :	24" o.c.
Roof Slope :	40 deg
Max Top Chord/Rafter Span :	20.72 ft
Bearing Wall Type :	Convl Lt-Frame Constr
Foundation :	Permanent Concrete
Stories :	Two

B. Building Design Criteria

Code :	2018 NCRC (ASCE 7-10)	Ground Snow Load :	10 psf
Roof Live Load :	20 psf (0 psf at panels)	Risk Category :	II
Min. Roof Snow Load :	Verify psf	Occupancy Class :	R-3
Ult Wind Speed :	118 mph	Roof Dead Load :	6.8 psf
Exposure Category :	C	PV Dead Load :	<u>3 psf</u>
		Total Dead Load :	9.8 psf

C. Summary of Existing Structure Results

Roof

After review of the field observations and based on our calculations and in accordance with the applicable building codes and current industry standards, the existing roof structure supporting the proposed alterations consisting of the solar array has been determined to be:

- Adequate to support the additional imposed loads. **No structural upgrades are required.**

D. Solar Panel Support Bracket Anchorage

1. Solar panels shall be designed, mounted, and installed in accordance with the most recent "SnapNrack Manual", which can be found on the SnapNrack website (<http://snapnrack.com/>).
2. Manufacturer's Panel Bracket Connection to Roof Chord/Rafter Member:

Fastener : (1) 5/16" Lag Screw per Bracket
NDS Withdrawl Value : 307 lbs/inch
Min. Thread Length and Penetration Depth : 2.5"

3. Considering the existing roof's slope, size, spacing, condition, and calculated loads, the panel bracket supports shall be placed no greater than 48 in. o/c.
4. Panel supports connections shall be staggered to distribute load to adjacent trusses.

E. Overall Summary

Based on the information supplied to us at the time of this report, on the evaluation of the existing structure, and solar array panel bracket connection, it is our opinion that the roof system will adequately support the additional loads imposed by the solar array. This evaluation conforms to 2018 NCRC and current industry standards.

Should you have any questions regarding this letter or if you require further information, do not hesitate to contact me.

Sincerely,

Michael Leeper, PE
License No. 47119



Limits of Scope of Work and Liability

The existing structure is assumed to have been designed and constructed following appropriate codes at the time of erection and assumed to have appropriated permits. The calculations performed are only for the roof framing supporting the solar array installation referenced in the stamped plans and were completed according to generally recognized structural analysis standards and procedures, professional engineering, and design experience opinions and judgements. Existing deficiencies which are unknown or were not observed during the time the site observation are not included in this scope of work. All solar panel modules, racking, and mounting equipment shall be designed and installed per the manufacturer's approved installation specifications. The Engineer of Record and the engineering consulting firm assume no responsibility for misuse or improper installation. This analysis is not stamped for water leakage. Framing was determined on information in provided plans and/or photos, along with engineering judgement. Prior to commencement of work, the contractor shall verify the framing sizes, spacings, and spans noted in the stamped plans, calculations, and/or certification letter and notify the Engineer of Record of any discrepancies prior to starting construction. If during solar panel installation, the roof framing members appear unstable or deflect non-uniformly, our office should be notified before proceeding with the installation. The contractor shall also verify that there are no damage/deficiencies (i.e., dry rot, water damage, termite damage, framing member/connection damage, etc.) to framing that was not addressed in the stamped plans, calculations, and/or certification letter and notify the Engineer of Record of any concerns prior to starting construction.

AERIAL VIEW

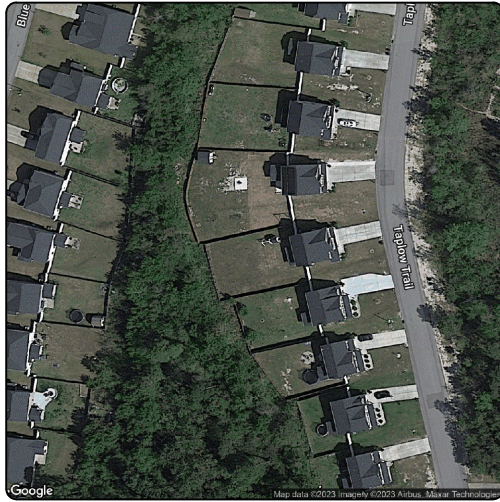

STREET VIEW



SHEET INDEX

- PV01 COVER
- PV02 SITE PLAN
- PV03 ROOF PLAN
- PV04 MOUNTING DETAIL
- PV05 LINE DIAGRAM
- PV06 ELECTRICAL CALCS
- PV07 LABELS
- PV08 PLACARD
- PV09 SITE PHOTOS

GENERAL NOTES

1. INSTALLATION OF SOLAR PHOTOVOLTAIC SYSTEM SHALL BE IN ACCORDANCE WITH NEC ARTICLE 690, AND ALL OTHER APPLICABLE NEC CODES WHERE NOTED OR EXISTING
2. PROPER ACCESS AND WORKING CLEARANCE AROUND EXISTING AND PROPOSED ELECTRICAL EQUIPMENT WILL COMPLY WITH NEC ARTICLE 110
3. ALL WIRES, INCLUDING THE GROUNDING ELECTRODE CONDUCTOR SHALL BE PROTECTED FROM PHYSICAL DAMAGE IN ACCORDANCE WITH NEC ARTICLE 250
4. THE PV MODULES ARE CONSIDERED NON-COMBUSTIBLE; THIS SYSTEM IS UTILITY INTERACTIVE PER UL 1741 AND DOES NOT INCLUDE STORAGE BATTERIES OR OTHER ALTERNATIVE STORAGE SOURCES
5. ALL DC WIRES SHALL BE SIZED ACCORDING TO [NEC 690.8]
6. DC CONDUCTORS SHALL BE WITHIN PROTECTED RACEWAYS IN ACCORDANCE WITH [NEC 690.31]
7. ALL SIGNAGE TO BE PLACED IN ACCORDANCE WITH LOCAL JURISDICTIONAL BUILDING CODE

PHOTOVOLTAIC (PV) SYSTEM SPECIFICATIONS

ELECTRICAL EQUIPMENT

PV MODULES:
 (26) HANWHA Q.PEAK DUO BLK ML-G10+ 400
 DC SYSTEM SIZE: 10.4 KW DC
 INVERTER(S):
 (26) ENPHASE IQ8PLUS-72-2-US INVERTER(S)
 AC SYSTEM SIZE: 7.54 KW AC

RACKING

RACKING: SNAPRACK SNAPRACK - ULTRA RAIL - UR-40
 ATTACHMENT: SPEEDSEAL FOOT

APPLICABLE GOVERNING CODES

2020 NATIONAL ELECTRICAL CODE
 2018 NORTH CAROLINA STATE BUILDING CODE: RESIDENTIAL
 2018 NORTH CAROLINA STATE BUILDING CODE: BUILDING
 2018 NORTH CAROLINA STATE BUILDING CODE: FIRE

SITE SPECIFICATIONS

OCCUPANCY: R-3
 ZONING: RESIDENTIAL

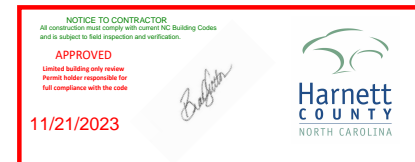

CONTRACTOR INFORMATION:
 ENCOR SOLAR, LLC
 3049 Executive Parkway
 Suite 300
 Lehi, UT 84043
 License # U.35743



SITE INFORMATION

AARON CASE

115 TAPLOW TRAIL
 CAMERON, NC 28326

AC SYSTEM SIZE: 7.54 KW AC

DC SYSTEM SIZE: 10.4 KW DC

LAT, 35.26371 LONG, -79.025904

(26) HANWHA Q.PEAK DUO BLK ML-G10+ 400
 PV MODULES

(26) ENPHASE IQ8PLUS-72-2-US INVERTER(S)

CENTRAL ELECTRIC MEMBERSHIP CORP

DRAWN BY: SoloCAD

11/2/2023

COVER - PV01

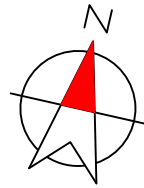

ARRAY DETAILS:		
MOUNTING PLANE:	AZIMUTH:	TILT:
MP1	167°	40°
MP2	257°	40°

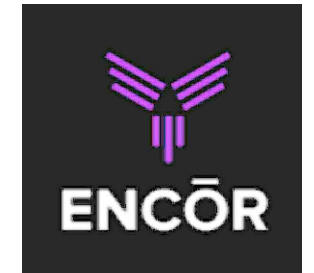

CONTRACTOR INFORMATION:
 ENCOR SOLAR, LLC
 3049 Executive Parkway
 Suite 300
 Lehi, UT 84043
 License # U.35743

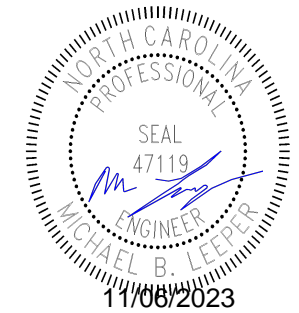
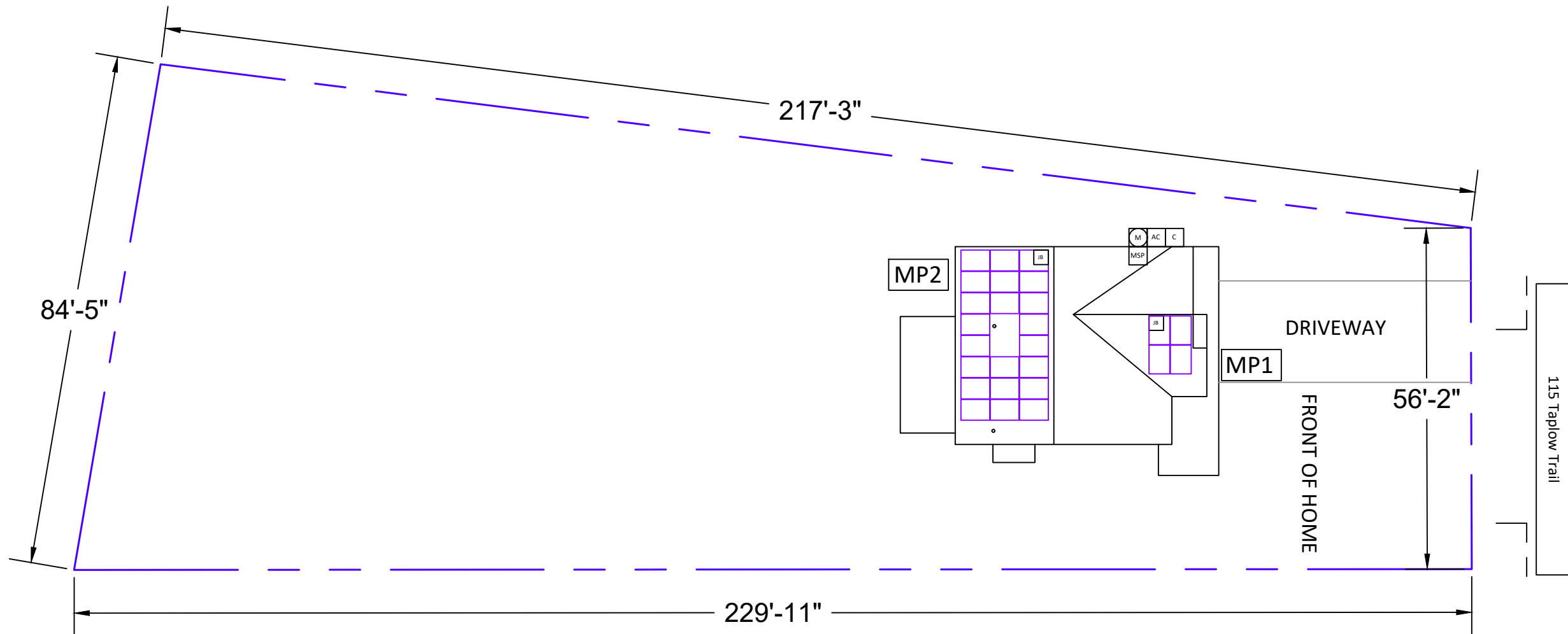

SITE INFORMATION

AARON CASE
 115 TAPLOW TRAIL
 CAMERON, NC 28326
 AC SYSTEM SIZE: 7.54 KW AC
 DC SYSTEM SIZE: 10.4 KW DC
 LAT, 35.26371 LONG, -79.025904
 (26) HANWHA Q.PEAK DUO BLK ML-G10+ 400 PV MODULES
 (26) ENPHASE IQ8PLUS-72-2-US INVERTER(S)

CENTRAL ELECTRIC MEMBERSHIP CORP

EQUIPMENT LEGEND:

- UTILITY METER
- VISIBLE, LOCKABLE, LABELED AC DISCONNECT
- INVERTER
- SUB PANEL
- SERVICE DISCONNECT
- PV MODULES
- FIRE ACCESS PATHWAY (3' TYP)
- MAIN SERVICE PANEL
- METER SOCKET (FOR UTILITY PV METER)
- COMBINER BOX
- LOAD CENTER
- BATTERY(IES)
- JUNCTION BOX
- PROPERTY LINE

VISIBLE, LOCKABLE, LABELED AC DISCONNECT LOCATED WITHIN 10' OF UTILITY METER

DRAWN BY: SoloCAD
 11/2/2023
 SITE PLAN - PV02

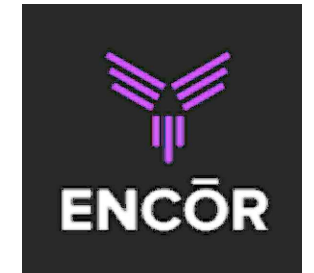
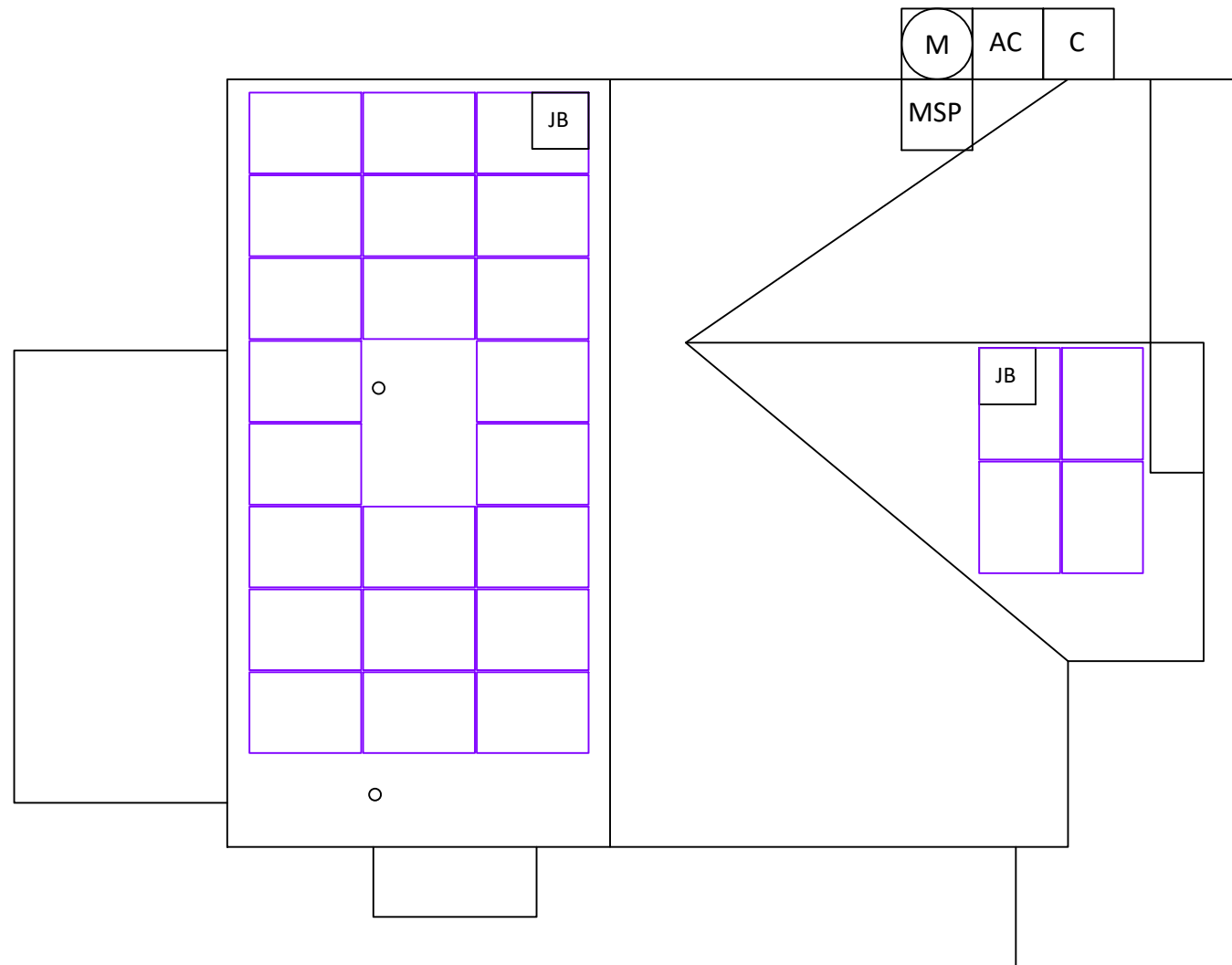
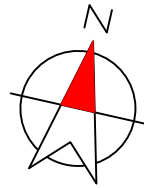

CONTRACTOR INFORMATION:
 ENCOR SOLAR, LLC
 3049 Executive Parkway
 Suite 300
 Lehi, UT 84043
 License # U.35743



SITE INFORMATION

AARON CASE

115 TAPLOW TRAIL
 CAMERON, NC 28326

AC SYSTEM SIZE: 7.54 KW AC

DC SYSTEM SIZE: 10.4 KW DC

LAT, 35.26371 LONG, -79.025904

(26) HANWHA Q.PEAK DUO BLK ML-G10+ 400 PV MODULES

(26) ENPHASE IQ8PLUS-72-2-US INVERTER(S)

CENTRAL ELECTRIC MEMBERSHIP CORP

DRAWN BY: SoloCAD

11/2/2023

ROOF PLAN - PV03

EQUIPMENT INFORMATION:		ROOF INFO:		PHOTOVOLTAIC ARRAY STRUCTURAL CRITERIA:	
RACKING MANUFACTURER:	SNAPNRACK	ROOF TYPE:	ASPHALT SHINGLE	PV MODULE COUNT:	26
RACKING PART NUMBER:	SNAPNRACK - ULTRA RAIL - UR-40	ROOF FRAMING:	MANUFACTURED TRUSS	ARRAY AREA:	MODULE COUNT * 21.14 FT ² = 549.64
ATTACHMENTS	SPEEDSEAL FOOT	RAFTER/TOP CHORD SIZE:	2x6	ROOF AREA:	1656 FT ²
ATTACHMENT QTY:	58	RAFTER/TOP CHORD SPACING:	24"	PERCENT OF ROOF COVERED:	33%
SPLICE QTY:	4	ATTACHMENT SPACING:	48"	ARRAY WEIGHT:	MODULE COUNT * 49 LBS = 1274 LBS
MIDCLAMP QTY:	40			POINT LOAD:	ARRAY LBS/ATTACHMENTS = 21.97
ENDCLAMP QTY:	24			DISTRIBUTED LOAD: (lbs/ft ²)	ARRAY WEIGHT/AREA = 2.32 LBS/FT ²

SNAPRACK UR SPEEDSEAL FOOT FOR COMPOSITION ROOF MOUNTING

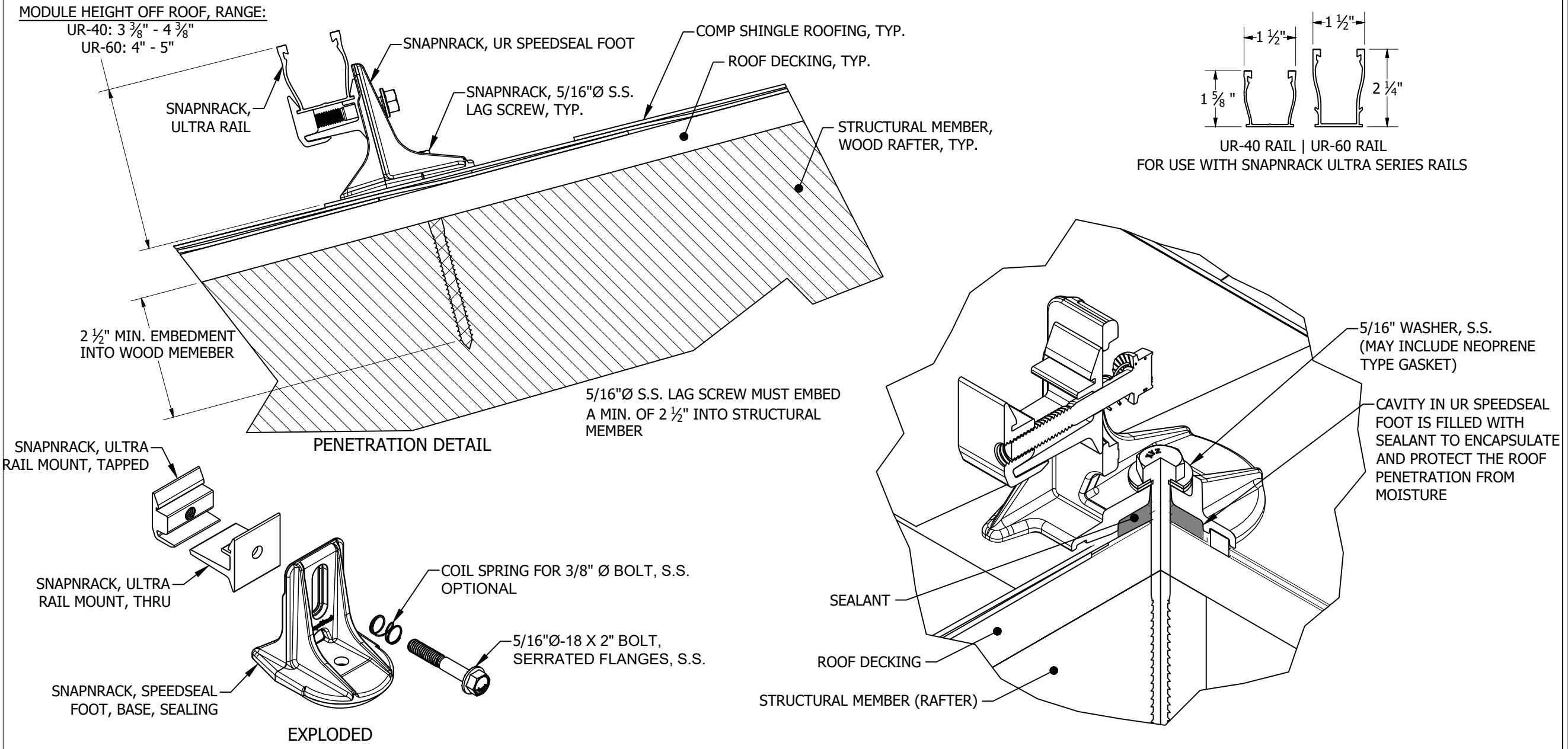

CONTRACTOR INFORMATION:
 ENCOR SOLAR, LLC
 3049 Executive Parkway
 Suite 300
 Lehi, UT 84043
 License # U.35743



SITE INFORMATION

AARON CASE
 115 TAPLOW TRAIL
 CAMERON, NC 28326
 AC SYSTEM SIZE: 7.54 KW AC
 DC SYSTEM SIZE: 10.4 KW DC
 LAT, 35.26371 LONG, -79.025904
 (26) HANWHA Q.PEAK DUO BLK ML-G10+ 400 PV MODULES
 (26) ENPHASE IQ8PLUS-72-2-US INVERTER(S)

EQUIPMENT INFORMATION:		ROOF INFO:		PHOTOVOLTAIC ARRAY STRUCTURAL CRITERIA:	
RACKING MANUFACTURER:	SNAPRACK	ROOF TYPE:	ASPHALT SHINGLE	PV MODULE COUNT:	26
RACKING PART NUMBER:	SNAPRACK - ULTRA RAIL - UR-40	ROOF FRAMING:	MANUFACTURED TRUSS	ARRAY AREA:	MODULE COUNT * 21.14 FT ² = 549.64
ATTACHMENTS	SPEEDSEAL FOOT	RAFTER/TOP CHORD SIZE:	2x6	ROOF AREA:	1656 FT ²
ATTACHMENT QTY:	58	RAFTER/TOP CHORD SPACING:	24"	PERCENT OF ROOF COVERED:	33%
SPLICE QTY:	4	ATTACHMENT SPACING:	48"	ARRAY WEIGHT:	MODULE COUNT * 49 LBS = 1274 LBS
MIDCLAMP QTY:	40			POINT LOAD:	ARRAY LBS/ATTACHMENTS = 21.97
ENDCLAMP QTY:	24			DISTRIBUTED LOAD: (lbs/ft ²)	ARRAY WEIGHT/AREA = 2.32 LBS/FT ²

CENTRAL ELECTRIC MEMBERSHIP CORP

DRAWN BY: SoloCAD

11/2/2023

MOUNTING DETAIL - PV04

HANWHA Q.PEAK DUO BLK ML-G10+ 400 SPECS	
POWER MAX (P _{MAX}):	400 W
OPEN CIRCUIT VOLTAGE (V _{OC}):	45.3 V
MAX POWER-POINT CURRENT (I _{MP}):	10.77 A
MAX POWER-POINT VOLTAGE (V _{MP}):	37.13 V
SHORT CIRCUIT CURRENT (I _{SC}):	11.14 A
SERIES FUSE RATING:	20 A

ENPHASE IQ8PLUS-72-2-US SPECS	
MAX INPUT VOLTAGE:	60 V
MAX DC SHORT CIRCUIT CURRENT:	15 A
MAXIMUM OUTPUT POWER:	290 W
MAXIMUM OUTPUT CURRENT:	1.21 A
NOM. OUTPUT VOLTAGE:	240 V
MAX UNITS PER 20A CIRCUIT:	13
1-PHASE, 60 HZ, UL 1741 LISTED	

EQUIPMENT SCHEDULE			
TYPE	QTY	DESCRIPTION	RATING
MODULES:	(26)	HANWHA Q.PEAK DUO BLK ML-G10+ 400	400 W
INVERTERS:	(26)	ENPHASE IQ8PLUS-72-2-US	290 W
AC DISCONNECT(S):	(1)	PV AC DISCONNECT, 240V, 2-POLE	60 A
AC COMBINER:	(1)	ENPHASE (X2-IQ-AM1-240-4)	125 A

CONDUIT & CONDUCTOR SCHEDULE				
TAG	QTY	WIRE GAUGE	DESCRIPTION	CONDUIT SIZE
1	(2)	12-2	ENPHASE Q-CABLE COPPER - (L1, L2)	N/A - FREE AIR
	(1)	6 AWG	BARE COPPER - (GROUND)	
2	(4)	10 AWG	THHN/THWN-2 COPPER - (L1, L2)	3/4" EMT
	(1)	10 AWG	THWN-2 COPPER - (GROUND)	
3	(3)	8 AWG	THHN/THWN-2 COPPER - (L1, L2, NEUTRAL)	3/4" EMT
	(1)	10 AWG	THWN-2 COPPER -(GROUND)	



CONTRACTOR INFORMATION:
ENCOR SOLAR, LLC
 3049 Executive Parkway
 Suite 300
 Lehi, UT 84043
 License # U.35743

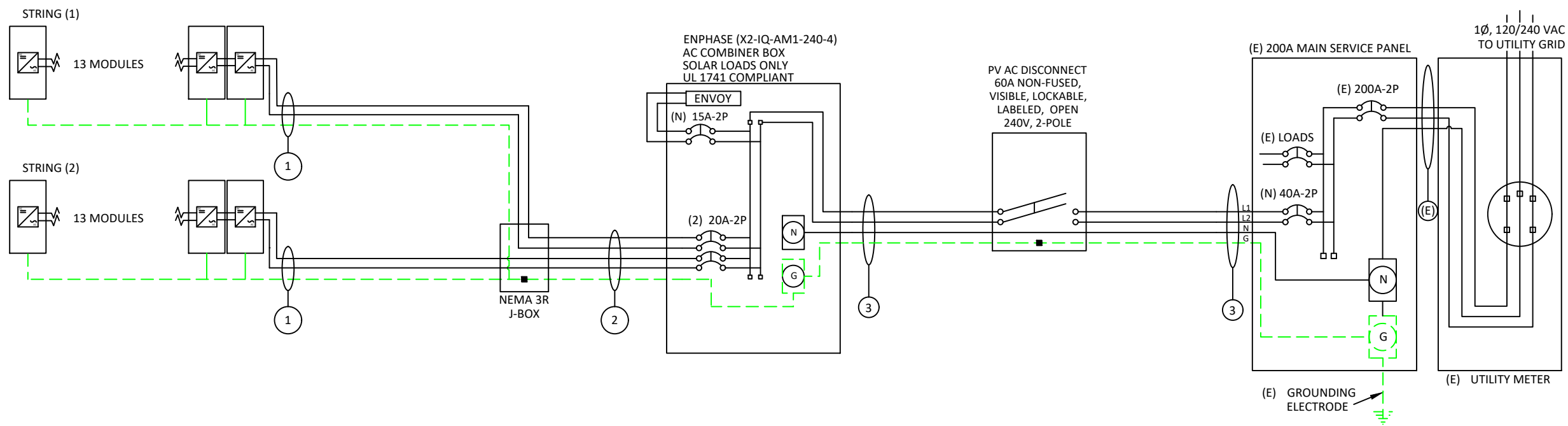

VISIBLE, LOCKABLE,
 LABELED AC DISCONNECT
 LOCATED WITHIN 10'
 OF UTILITY METER

SITE INFORMATION
AARON CASE
 115 TAPLOW TRAIL
 CAMERON, NC 28326
 AC SYSTEM SIZE: 7.54 KW AC
 DC SYSTEM SIZE: 10.4 KW DC
 LAT, 35.26371 LONG, -79.025904
 (26) HANWHA Q.PEAK DUO BLK ML-G10+ 400 PV MODULES
 (26) ENPHASE IQ8PLUS-72-2-US INVERTER(S)

CENTRAL ELECTRIC MEMBERSHIP CORP

DRAWN BY: SoloCAD

11/2/2023

LINE DIAGRAM - PV05

STRING CALCULATIONS		
	STRING #1	STRING #2
MAX AC CURRENT:	15.73A	15.73A
MICRO INVERTERS IN CIRCUIT	13	13
NOMINAL STRING VOLTAGE:	240V	240V
MAX AC OUTPUT POWER	3770W	3770W
ARRAY DC POWER:	10400W	
TOTAL MAX AC CURRENT:	31.46A	

SYSTEM OCPD CALCULATIONS	
INVERTER MODEL(S):	ENPHASE IQ8PLUS-72-2-US
# OF INVERTERS:	26
MAX OUTPUT CURRENT:	1.21A
(# OF INVERTERS) X (MAX OUTPUT CURRENT) X 125% <= OCPD RATING	
(26 X 1.21A X 1.25) = 39A <= 40A, OK	

NUMBER OF CURRENT CARRYING CONDUCTORS	PERCENT OF VALUES
4-6	.80
7-9	.70
10-20	.50

BUSBAR CALCULATIONS - 120% RULE	
MAIN BUSBAR RATING:	200A
MAIN DISCONNECT RATING:	200A
PV OCPD RATING:	40A
(MAIN BUS RATING X 120%) - MAIN DISCONNECT RATING >= OCPD RATING	
(200A X 1.2) - 200A = 40A, >= 40A, OK	

CONDUIT & CONDUCTOR SCHEDULE											
TAG	QTY	WIRE GAUGE	DESCRIPTION	CONDUIT SIZE	CONDUCTOR RATING	CONDUCTOR TEMP. RATE	AMBIENT TEMP	TEMP. DERATE	# OF CONDUCTORS DERATE	CONDUCTOR RATING W/DERATES	CONDUIT FILL
1	(2)	12-2	ENPHASE Q-CABLE COPPER - (L1, L2)	N/A - FREE AIR	30A	90°C	36°C	0.91	N/A - FREE AIR	27.3A	N/A - FREE AIR
	(1)	6 AWG	BARE COPPER - (GROUND)								
2	(4)	10 AWG	THHN/THWN-2 COPPER - (L1, L2)	3/4" EMT	40A	90°C	36°C	0.91	0.8	29.12A	19.8%
	(1)	10 AWG	THWN-2 COPPER - (GROUND)								
3	(3)	8 AWG	THHN/THWN-2 COPPER - (L1, L2, NEUTRAL)	3/4" EMT	50A	75°C	36°C	0.88	1	44A	24.6%
	(1)	10 AWG	THWN-2 COPPER -(GROUND)								



CONTRACTOR INFORMATION:
ENCOR SOLAR, LLC
 3049 Executive Parkway
 Suite 300
 Lehi, UT 84043
 License # U.35743

SITE INFORMATION

AARON CASE

115 TAPLOW TRAIL
 CAMERON, NC 28326

AC SYSTEM SIZE: 7.54 KW AC

DC SYSTEM SIZE: 10.4 KW DC

LAT, 35.26371 LONG, -79.025904

(26) HANWHA Q.PEAK DUO BLK ML-G10+ 400 PV MODULES

(26) ENPHASE IQ8PLUS-72-2-US INVERTER(S)

CENTRAL ELECTRIC MEMBERSHIP CORP

DRAWN BY: SoloCAD

11/2/2023

ELECTRICAL CALCS - PV06

GROUNDING & GENERAL NOTES:

- PV INVERTER IS UNGROUNDED, TRANSFORMER-LESS TYPE.
- DC GEC AND AC EGC TO BE SPICED TO EXISTING ELECTRODE
- ANY EXISTING WIRING INVOLVED WITH PV SYSTEM CONNECTION THAT IS FOUND TO BE INADEQUATE PER CODE SHALL BE CORRECTED PRIOR TO FINAL INSPECTION.
- JUNCTION BOX QUANTITIES, AND PLACEMENT SUBJECT TO CHANGE IN THE FIELD - JUNCTION BOXES DEPICTED ON ELECTRICAL DIAGRAM REPRESENT WIRE TYPE TRANSITIONS.
- AC DISCONNECT NOTED IN EQUIPMENT SCHEDULE OPTIONAL IF OTHER AC DISCONNECTING MEANS IS LOCATED WITHIN 10' OF SERVICE DISCONNECT.

INTERCONNECTION NOTES:

- INTERCONNECTION SIZING, LIMITATIONS AND COMPLIANCE DETERMINED IN ACCORDANCE WITH [NEC 705.12].
- GROUND FAULT PROTECTION IN ACCORDANCE WITH [NEC 215.9], [NEC 230.95] AND [NEC 690.41]
- ALL EQUIPMENT TO BE RATED FOR BACKFEEDING.
- PV BREAKER TO BE POSITIONED AT THE OPPOSITE END OF THE BUSBAR RELATIVE TO THE MAIN BREAKER.

DISCONNECT NOTES:

- DISCONNECTING SWITCHES SHALL BE WIRED SUCH THAT WHEN THE SWITCH IS OPENED THE CONDUCTORS REMAINING LIVE ARE CONNECTED TO THE TERMINALS MARKED "LINE SIDE" (TYPICALLY THE UPPER TERMINALS)
- AC DISCONNECT MUST BE ACCESSIBLE TO QUALIFIED UTILITY PERSONNEL, BE LOCKABLE, AND BE A VISIBLE-BREAK SWITCH

MAIN PHOTOVOLTAIC SYSTEM DISCONNECT

LABEL 1
PLACED ON THE MAIN DISCONNECTING MEANS FOR THE PV SYSTEM.
[NEC 690.13(B)]

PHOTOVOLTAIC AC DISCONNECT

RATED AC OUTPUT CURRENT: **31**
NOMINAL OPERATING AC VOLTAGE: **240**

LABEL 6
MARKED AT AC DISCONNECTING MEANS.
[NEC 690.54]

PHOTOVOLTAIC POWER SOURCE

SOLAR PV SYSTEM EQUIPPED WITH RAPID SHUTDOWN

TURN RAPID SHUTDOWN SWITCH TO THE "OFF" POSITION TO SHUT DOWN PV SYSTEM AND REDUCE SHOCK HAZARD IN ARRAY

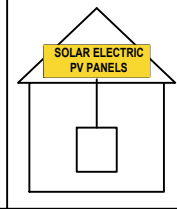

LABEL 7
AT DIRECT-CURRENT EXPOSED RACEWAYS, CABLE TRAYS, COVERS AND ENCLOSURES OF JUNCTION BOXES, AND OTHER WIRING METHODS; SPACED AT MAXIMUM 10FT SECTION OR WHERE SEPARATED BY ENCLOSURES, WALLS, PARTITIONS, CEILINGS, OR FLOORS.
[NEC 690.31(D)(2)]

LABEL 8
FOR PV SYSTEMS THAT SHUT DOWN THE ARRAY AND CONDUCTORS LEAVING THE ARRAY:
SIGN TO BE LOCATED ON OR NO MORE THAN 3 FT AWAY FROM SERVICE DISCONNECTING MEANS TO WHICH THE PV SYSTEMS ARE CONNECTED AND SHALL INDICATE THE LOCATION OF ALL IDENTIFIED RAPID SHUTDOWN SWITCHES IF NOT AT THE SAME LOCATION.
[NEC 690.56(C)(1)]

RAPID SHUTDOWN SWITCH FOR SOLAR PV SYSTEM

LABEL 9
SIGN LOCATED ON OR NO MORE THAN 3FT FROM INITIATION DEVICE
[NEC 690.56(C)(2)].

WARNING
ELECTRIC SHOCK HAZARD
TERMINALS ON THE LINE AND LOAD SIDES MAY BE ENERGIZED IN THE OPEN POSITION

LABEL 2
FOR PV DISCONNECTING MEANS WHERE THE LINE AND LOAD TERMINALS MAY BE ENERGIZED IN THE OPEN POSITION.
[NEC 690.13(B)]

WARNING
POWER SOURCE OUTPUT CONNECTION.
DO NOT RELOCATE THIS OVERCURRENT DEVICE.

LABEL 3
PLACED ADJACENT TO THE BACK-FED BREAKER FROM THE INVERTER IF TIE IN CONSISTS OF LOAD SIDE CONNECTION TO BUSBAR.
[NEC 705.12(B)(3)(2)]

CAUTION
MULTIPLE SOURCES OF POWER

LABEL 4
PLACED ON EQUIPMENT CONTAINING OVERCURRENT DEVICES IN CIRCUITS SUPPLYING POWER TO A BUSBAR OR CONDUCTOR SUPPLIED FROM MULTIPLE SOURCES
[NEC 705.10]

WARNING
THIS EQUIPMENT IS FED BY MULTIPLE SOURCES. TOTAL RATING OF ALL OVERCURRENT DEVICES, EXCLUDING MAIN SUPPLY OVERCURRENT DEVICE, SHALL NOT EXCEED AMPACITY OF BUSBAR.

LABEL 5
EQUIPMENT CONTAINING OVERCURRENT DEVICES IN CIRCUITS SUPPLYING POWER TO A BUSBAR OR CONDUCTOR SUPPLIED FROM MULTIPLE SOURCES SHALL BE MARKED TO INDICATE THE PRESENCE OF ALL SOURCES.[NEC 705.12(B)(3)(3)]



CONTRACTOR INFORMATION:
ENCOR SOLAR, LLC
3049 Executive Parkway
Suite 300
Lehi, UT 84043
License # U.35743

SITE INFORMATION

AARON CASE
115 TAPLOW TRAIL
CAMERON, NC 28326
AC SYSTEM SIZE: 7.54 KW AC
DC SYSTEM SIZE: 10.4 KW DC
LAT, 35.26371 LONG, -79.025904
(26) HANWHA Q.PEAK DUO BLK ML-G10+ 400 PV MODULES
(26) ENPHASE IQ8PLUS-72-2-US INVERTER(S)

CENTRAL ELECTRIC MEMBERSHIP CORP

DRAWN BY: SoloCAD

11/2/2023

LABELS - PV07

LABELING NOTES:

1. LABELS CALLED OUT ACCORDING TO ALL COMMON CONFIGURATIONS. ELECTRICIAN TO DETERMINE EXACT REQUIREMENTS IN THE FIELD PER CURRENT NEC AND LOCAL CODES AND MAKE APPROPRIATE ADJUSTMENTS.
2. LABELING REQUIREMENTS BASED ON THE 2020 NATIONAL ELECTRIC CODE, OSHA STANDARD 19010.145, ANSI Z535.
3. MATERIAL BASED ON THE REQUIREMENTS OF THE AUTHORITY HAVING JURISDICTION.
4. LABELS TO BE OF SUFFICIENT DURABILITY TO WITHSTAND THE ENVIRONMENT INVOLVED [NEC 110.21]
5. LABELS TO BE A MINIMUM LETTER HEIGHT OF 3/8", WHITE ON RED BACKGROUND; REFLECTIVE, AND PERMANENTLY AFFIXED.[NEC 690.31(D)(2)]

LABELING DIAGRAM:

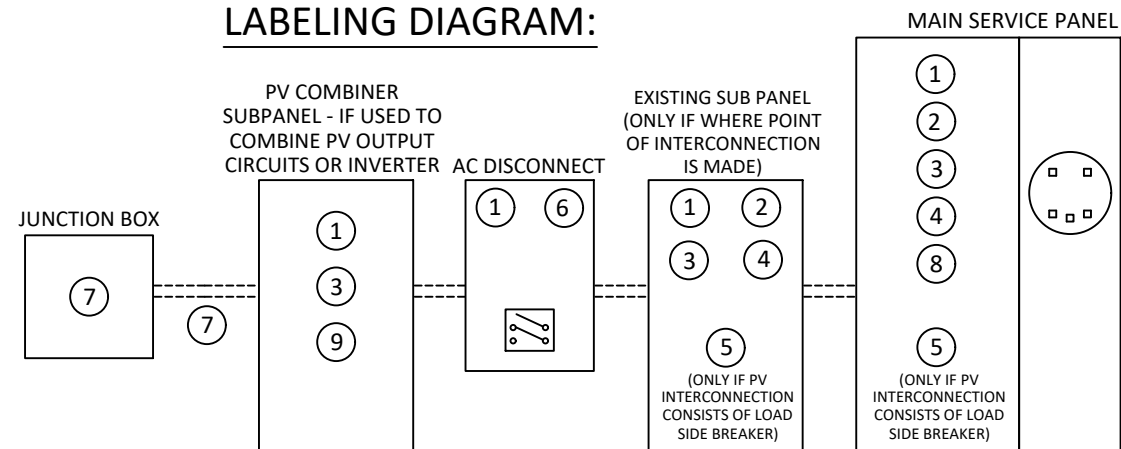

** ELECTRICAL DIAGRAM SHOWN ABOVE IS FOR LABELING PURPOSES ONLY. NOT AN ACTUAL REPRESENTATION OF EQUIPMENT AND CONNECTIONS TO BE INSTALLED. LABEL LOCATIONS PRESENTED MAY VARY DEPENDING ON TYPE OF INTERCONNECTION METHOD AND LOCATION PRESENTED ELECTRICAL DIAGRAM PAGE. **

CAUTION

POWER TO THIS BUILDING IS ALSO SUPPLIED FROM ROOF MOUNTED SOLAR ARRAYS WITH SAFETY DISCONNECTS AS SHOWN:

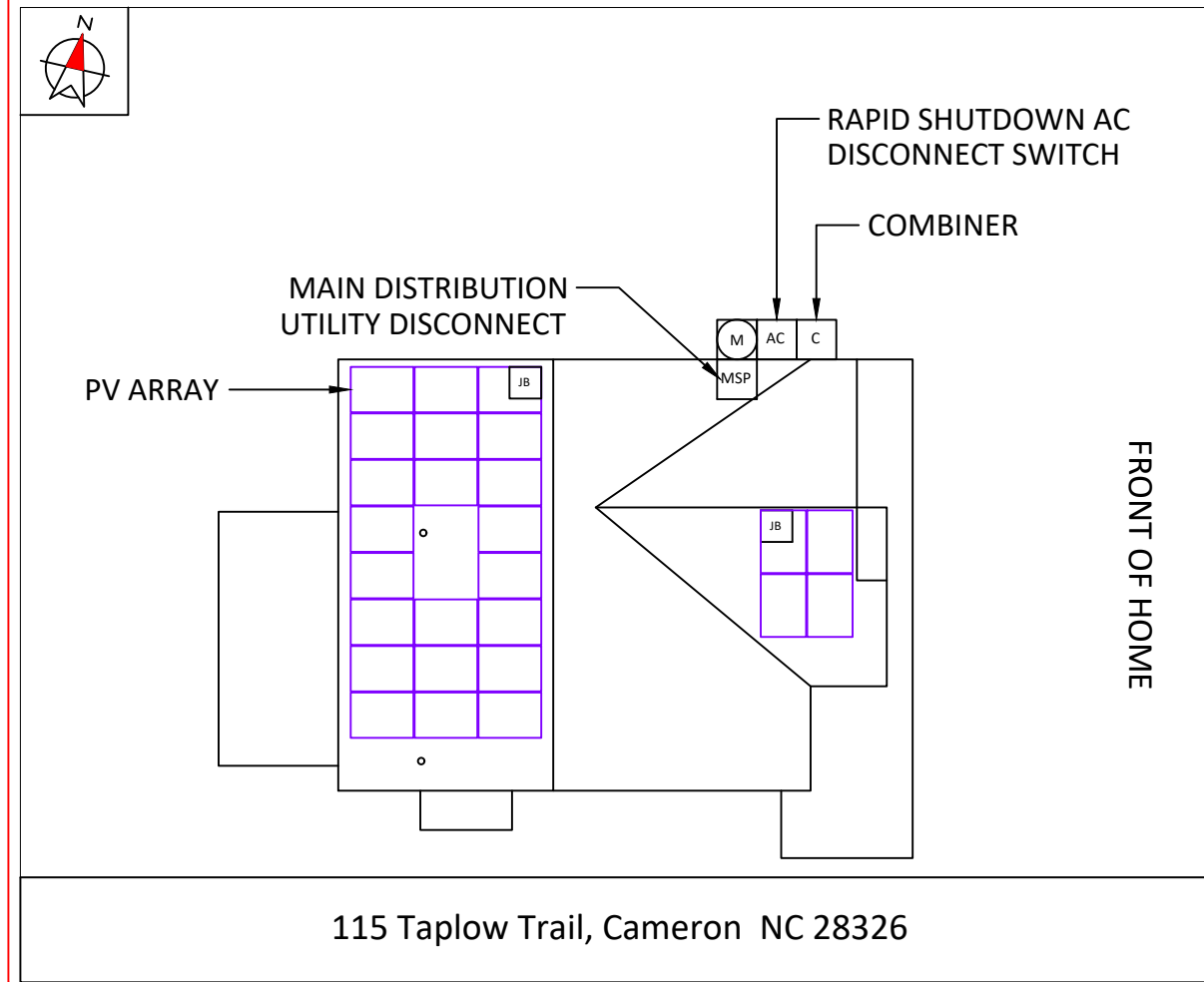

DIRECTORY:

PERMANENT PLAQUE OR DIRECTORY PROVIDING THE LOCATION OF THE SERVICE DISCONNECTING MEANS AND THE PHOTOVOLTAIC SYSTEM.
(ALL PLAQUES AND SIGNAGE WILL BE INSTALLED AS OUTLINED WITHIN: NEC 690.56(B)&(C), [NEC 705.10]



CONTRACTOR INFORMATION:

ENCOR SOLAR, LLC
3049 Executive Parkway
Suite 300
Lehi, UT 84043
License # U.35743

SITE INFORMATION

AARON CASE

115 TAPLOW TRAIL
CAMERON, NC 28326

AC SYSTEM SIZE: 7.54 KW AC

DC SYSTEM SIZE: 10.4 KW DC

LAT, 35.26371 LONG, -79.025904

(26) HANWHA Q.PEAK DUO BLK ML-G10+ 400
PV MODULES

(26) ENPHASE IQ8PLUS-72-2-US INVERTER(S)

CENTRAL ELECTRIC MEMBERSHIP CORP

DRAWN BY: SoloCAD

11/2/2023

PLACARD - PV08

SITE PHOTOS:



CONTRACTOR INFORMATION:
ENCOR SOLAR, LLC
3049 Executive Parkway
Suite 300
Lehi, UT 84043
License # U.35743

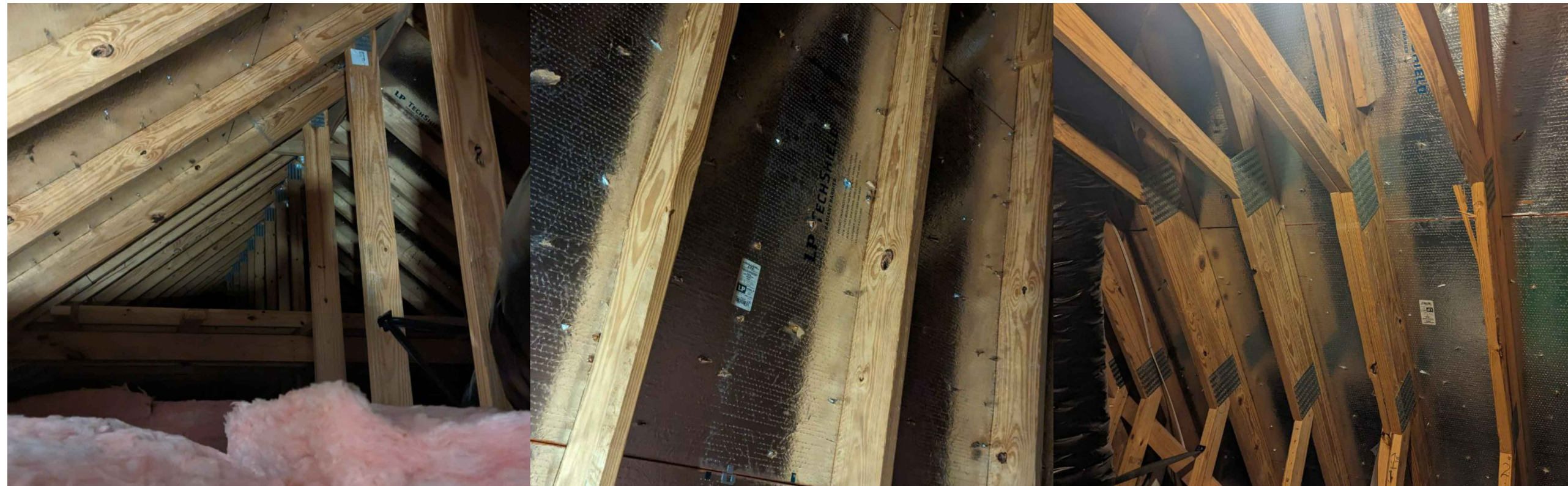

SITE INFORMATION

AARON CASE

115 TAPLOW TRAIL
CAMERON, NC 28326

AC SYSTEM SIZE: 7.54 KW AC

DC SYSTEM SIZE: 10.4 KW DC

LAT, 35.26371 LONG, -79.025904

(26) HANWHA Q.PEAK DUO BLK ML-G10+ 400
PV MODULES

(26) ENPHASE IQ8PLUS-72-2-US INVERTER(S)

CENTRAL ELECTRIC MEMBERSHIP CORP

DRAWN BY: SoloCAD

11/2/2023

SITE PHOTOS - PV09

powered by
Q.ANTUM DUO Z

Q.PEAK DUO BLK ML-G10+ 385-410

ENDURING HIGH
PERFORMANCE



BREAKING THE 20% EFFICIENCY BARRIER

Q.ANTUM DUO Z Technology with zero gap cell layout boosts module efficiency up to 21.1%.



THE MOST THOROUGH TESTING PROGRAMME IN THE INDUSTRY

Q CELLS is the first solar module manufacturer to pass the most comprehensive quality programme in the industry. The new "Quality Controlled PV" of the independent certification institute TÜV Rheinland.



INNOVATIVE ALL-WEATHER TECHNOLOGY

Optimal yields, whatever the weather with excellent low-light and temperature behaviour.



ENDURING HIGH PERFORMANCE

Long-term yield security with Anti LID Technology, Hot-Spot Protect and Traceable Quality Tra.Q™.



EXTREME WEATHER RATING

High-tech aluminium alloy frame, certified for high snow (5400Pa) and wind loads (4000Pa).



A RELIABLE INVESTMENT

Inclusive 25-year product warranty and 25-year linear performance warranty¹.

¹ See data sheet on rear for further information.

THE IDEAL SOLUTION FOR:

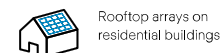

Rooftop arrays on residential buildings

Engineered in Germany

Q CELLS

MECHANICAL SPECIFICATION

Format	1879 mm × 1045 mm × 32 mm (including frame)
Weight	22.0 kg
Front Cover	3.2 mm thermally pre-stressed glass with anti-reflection technology
Back Cover	Composite film
Frame	Black anodised aluminium
Cell	6 × 22 monocrystalline Q.ANTUM solar half cells
Junction box	53-101 mm × 32-60 mm × 15-18 mm Protection class IP67, with bypass diodes
Cable	4 mm ² Solar cable; (+) ≥1250 mm, (-) ≥1250 mm
Connector	Stäubli MC4; IP68

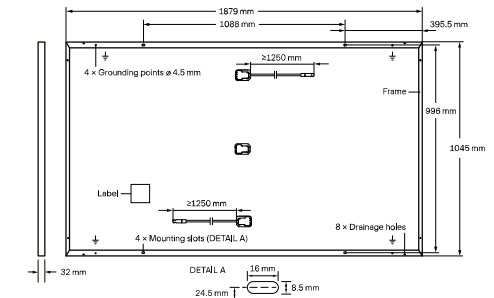

ELECTRICAL CHARACTERISTICS

POWER CLASS		385	390	395	400	405	410	
MINIMUM PERFORMANCE AT STANDARD TEST CONDITIONS, STC ¹ (POWER TOLERANCE +5 W / -0 W)								
Minimum	Power at MPP ¹	P _{MPP} [W]	385	390	395	400	405	410
	Short Circuit Current ¹	I _{SC} [A]	11.04	11.07	11.10	11.14	11.17	11.20
	Open Circuit Voltage ¹	V _{OC} [V]	45.19	45.23	45.27	45.30	45.34	45.37
	Current at MPP	I _{MPP} [A]	10.59	10.65	10.71	10.77	10.83	10.89
	Voltage at MPP	V _{MPP} [V]	36.36	36.62	36.88	37.13	37.39	37.64
	Efficiency ²	η [%]	≥19.6	≥19.9	≥20.1	≥20.4	≥20.6	20.9
MINIMUM PERFORMANCE AT NORMAL OPERATING CONDITIONS, NMOT ²								
Minimum	Power at MPP	P _{MPP} [W]	288.8	292.6	296.3	300.1	303.8	307.6
	Short Circuit Current	I _{SC} [A]	8.90	8.92	8.95	8.97	9.00	9.03
	Open Circuit Voltage	V _{OC} [V]	42.62	42.65	42.69	42.72	42.76	42.79
	Current at MPP	I _{MPP} [A]	8.35	8.41	8.46	8.51	8.57	8.62
	Voltage at MPP	V _{MPP} [V]	34.59	34.81	35.03	35.25	35.46	35.68

¹ Measurement tolerances P_{MPP} ± 3%; I_{SC}; V_{OC} ± 5% at STC: 1000 W/m², 25 ± 2 °C, AM 1.5 according to IEC 60904-3 • 1800 W/m², NMOT, spectrum AM 1.5

Q CELLS PERFORMANCE WARRANTY

PERFORMANCE AT LOW IRRADIANCE

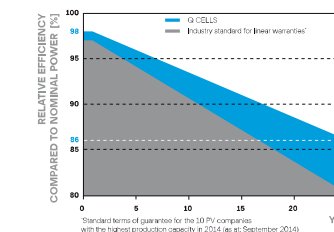

At least 98% of nominal power during first year. Thereafter max. 0.5% degradation per year. At least 93.5% of nominal power up to 10 years. At least 86% of nominal power up to 25 years.

All data within measurement tolerances. Full warranties in accordance with the warranty terms of the Q CELLS sales organisation of your respective country.

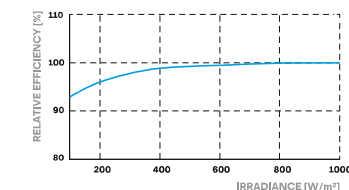

Typical module performance under low irradiance conditions in comparison to STC conditions (25 °C, 1000 W/m²).

TEMPERATURE COEFFICIENTS

Temperature Coefficient of I _{SC}	α [%/K]	+0.04	Temperature Coefficient of V _{OC}	β [%/K]	-0.27
Temperature Coefficient of P _{MPP}	γ [%/K]	-0.34	Nominal Module Operating Temperature	NMOT [°C]	43 ± 3

PROPERTIES FOR SYSTEM DESIGN

Maximum System Voltage	V _{sys} [V]	1000	PV module classification	Class II
Maximum Reverse Current	I _r [A]	20	Fire Rating based on ANSI / UL 61730	C / TYPE 2
Max. Design Load, Push / Pull	[Pa]	3600 / 2660	Permitted Module Temperature on Continuous Duty	-40 °C - +85 °C
Max. Test Load, Push / Pull	[Pa]	5400 / 4000		

QUALIFICATIONS AND CERTIFICATES

Quality Controlled PV - TÜV Rheinland; IEC 61215:2016; IEC 61730:2016. This data sheet complies with DIN EN 50380. Q-CPV Certification ongoing. Certification holder: Hanwha Q CELLS GmbH



PACKAGING INFORMATION

Horizontal packaging	1940mm	1100mm	1220mm	751kg	28 pallets	24 pallets	32 modules
----------------------	--------	--------	--------	-------	------------	------------	------------

Note: Installation instructions must be followed. See the installation and operating manual or contact our technical service department for further information on approved installation and use of this product.

Made in Korea

Hanwha Q CELLS Australia Pty Ltd

Suite 1, Level 1, 15 Blue Street, North Sydney, NSW 2060, Australia | TEL +61 (0)2 9016 3033 | FAX +61 (0)2 9016 3032 | EMAIL q-cells-australia@q-cells.com | WEB www.q-cells.com/au

Engineered in Germany

Q CELLS



IQ8 and IQ8+ Microinverters

Our newest IQ8 Microinverters are the industry's first microgrid-forming, software-defined microinverters with split-phase power conversion capability to convert DC power to AC power efficiently. The brain of the semiconductor-based microinverter is our proprietary application-specific integrated circuit (ASIC), which enables the microinverter to operate in grid-tied or off-grid modes. This chip is built using advanced 55-nm technology with high-speed digital logic and has superfast response times to changing loads and grid events, alleviating constraints on battery sizing for home energy systems.



Part of the Enphase Energy System, IQ8 Series Microinverters integrate with the IQ Battery, IQ Gateway, and the Enphase App monitoring and analysis software.



IQ8 Series Microinverters redefine reliability standards with more than one million cumulative hours of power-on testing, enabling an industry-leading limited warranty of up to 25 years.



Connect PV modules quickly and easily to IQ8 Series Microinverters using the included Q-DCC-2 adapter cable with plug-and-play MC4 connectors.



IQ8 Series Microinverters are UL Listed as PV rapid shutdown equipment and conform with various regulations, when installed according to the manufacturer's instructions.

*Meets UL 1741 only when installed with IQ System Controller 2.
**IQ8 and IQ8+ support split-phase, 240 V installations only.

Easy to install

- Lightweight and compact with plug-and-play connectors
- Power line communication (PLC) between components
- Faster installation with simple two-wire cabling

High productivity and reliability

- Produce power even when the grid is down*
- More than one million cumulative hours of testing
- Class II double-insulated enclosure
- Optimized for the latest high-powered PV modules

Microgrid-forming

- Compliant with the latest advanced grid support**
- Remote automatic updates for the latest grid requirements
- Configurable to support a wide range of grid profiles
- Meet CA Rule 21 (UL 1741-SA) and IEEE® 1547:2018 (UL 1741-SB 3rd Ed.)

NOTE:

- IQ8 Microinverters cannot be mixed with previous generations of Enphase microinverters (IQ7 Series, IQ6 Series, and so on) in the same system.
- IQ Gateway is required to change the default grid profile at the time of installation to meet local Authority Having Jurisdiction (AHJ) requirements.

IQ8 and IQ8+ Microinverters

INPUT DATA (DC)	UNITS	IQ8-60-2-US	IQ8PLUS-72-2-US
Commonly used module pairings ¹	W	235-350	235-440
Module compatibility	–	To meet compatibility, PV modules must be within maximum input DC voltage and maximum module I _{sc} listed below. Module compatibility can be checked at https://enphase.com/installers/microinverters/calculator	
MPPT voltage range	V	27-37	27-45
Operating range	V	16-48	16-58
Minimum/Maximum start voltage	V	22/48	22/58
Maximum input DC voltage	V	50	60
Maximum continuous input DC current	A	10	12
Maximum input DC short-circuit current	A	25	
Maximum module I _{sc}	A	20	
Overvoltage class DC port	–	II	
DC port backfeed current	mA	0	
PV array configuration	–	1 × 1 ungrounded array; no additional DC side protection required; AC side protection requires maximum 20 A per branch circuit.	
OUTPUT DATA (AC)	UNITS	IQ8-60-2-US	IQ8PLUS-72-2-US
Peak output power	VA	245	300
Maximum continuous output power	VA	240	290
Nominal grid voltage (L-L)	V	240, split-phase (L-L), 180°	
Minimum and Maximum grid voltage ²	V	211-264	
Maximum continuous output current	A	1.0	1.21
Nominal frequency	Hz	60	
Extended frequency range	Hz	47-68	
AC short-circuit fault current over three cycles	Arms	2	
Maximum units per 20 A (L-L) branch circuit ³	–	16	13
Total harmonic distortion	%	<5	
Overvoltage class AC port	–	III	
AC port backfeed current	mA	30	
Power factor setting	–	1.0	
Grid-tied power factor (adjustable)	–	0.85 leading ... 0.85 lagging	
Peak efficiency	%	97.7	
CEC weighted efficiency	%	97	
Nighttime power consumption	mW	23	25
MECHANICAL DATA			
Ambient temperature range		-40°C to 60°C (-40°F to 140°F)	
Relative humidity range		4% to 100% (condensing)	
DC connector type		MC4	
Dimensions (H × W × D)		212 mm (8.3 in) × 175 mm (6.9 in) × 30.2 mm (1.2 in)	
Weight		1.08 kg (2.38 lbs)	
Cooling		Natural convection—no fans	
Approved for wet locations		Yes	
Pollution degree		PD3	
Enclosure		Class II double-insulated, corrosion-resistant polymeric enclosure	
Environmental category/UV exposure rating		NEMA Type 6/Outdoor	

(1) No enforced DC/AC ratio.
(2) Nominal voltage range can be extended beyond nominal if required by the utility.
(3) Limits may vary. Refer to local requirements to define the number of microinverters per branch in your area.

IQ8 and IQ8+ Microinverters

COMPLIANCE	
Certifications	CA Rule 21 (UL 1741-SA), UL 62109-1, IEEE® 1547:2018 (UL 1741-SB 3 rd Ed.), FCC Part 15 Class B, ICES-0003 Class B, CAN/CSA-C22.2 NO. 107.1-01 This product is UL Listed as PV rapid shutdown equipment and conforms with NEC 2014, NEC 2017, NEC 2020, and NEC 2023 section 690.12 and C22.1-2018 Rule 64-218 rapid shutdown of PV Systems, for AC and DC conductors, when installed according to the manufacturer's instructions.

IQ8 and IQ8+ Microinverters

Revision history

REVISION	DATE	DESCRIPTION
DSH-00207-2.0	October 2023	Included NEC 2023 specification in the Compliance section
DSH-00207-1.0	September 2023	Updated module compatibility specification

IQ Combiner 4/4C



The **IQ Combiner 4/4C** with IQ Gateway and integrated LTE-M1 cell modem (included only with IQ Combiner 4C) consolidates interconnection equipment into a single enclosure. It streamlines IQ Microinverters and storage installations by providing a consistent, pre-wired solution for residential applications. It offers up to four 2-pole input circuits and Eaton BR series busbar assembly.

Smart

- Includes IQ Gateway for communication and control
- Includes Mobile Connect cellular modem (CELLMODEM-M1-06-SP-05), included only with IQ Combiner 4C
- Includes solar shield to match Enphase IQ Battery aesthetics and deflect heat
- Supports Wi-Fi, Ethernet, or cellular connectivity
- Optional AC receptacle available for PLC bridge
- Provides production metering and consumption monitoring

Simple

- Mounts on single stud with centered brackets
- Supports bottom, back and side conduit entry
- Allows up to four 2-pole branch circuits for 240VAC plug-in breakers (not included)
- 80A total PV or storage branch circuits

Reliable

- Durable NRTL-certified NEMA type 3R enclosure
- Five-year limited warranty
- Two years labor reimbursement program coverage included for both the IQ Combiner SKU's
- UL listed
- X2-IQ-AM1-240-4 and X2-IQ-AM1-240-4C comply with IEEE 1547:2018 (UL 1741-SB, 3rd Ed.)

IQ Combiner 4/4C

MODEL NUMBER	
IQ Combiner 4 X-IQ-AM1-240-4 X2-IQ-AM1-240-4 (IEEE 1547:2018)	IQ Combiner 4 with IQ Gateway printed circuit board for integrated revenue grade PV production metering (ANSI C12.20 ± 0.5%) and consumption monitoring (± 2.5%). Includes a silver solar shield to match the IQ Battery and IQ System Controller 2 and to deflect heat.
IQ Combiner 4C X-IQ-AM1-240-4C X2-IQ-AM1-240-4C (IEEE 1547:2018)	IQ Combiner 4C with IQ Gateway printed circuit board for integrated revenue grade PV production metering (ANSI C12.20 ± 0.5%) and consumption monitoring (± 2.5%). Includes Mobile Connect cellular modem (CELLMODEM-M1-06-SP-05), a plug-and-play industrial-grade cell modem for systems up to 60 microinverters. (Available in the US, Canada, Mexico, Puerto Rico, and the US Virgin Islands, where there is adequate cellular service in the installation area.) Includes a silver solar shield to match the IQ Battery and IQ System Controller and to deflect heat.
ACCESSORIES AND REPLACEMENT PARTS (not included, order separately)	
Supported microinverters	IQ6, IQ7, and IQ8. (Do not mix IQ6/7 Microinverters with IQ8)
Communications Kit COMMS-CELLMODEM-M1-06 CELLMODEM-M1-06-SP-05 CELLMODEM-M1-06-AT-05	- Includes COMMS-KIT-01 and CELLMODEM-M1-06-SP-05 with 5-year Sprint data plan - 4G based LTE-M1 cellular modem with 5-year Sprint data plan - 4G based LTE-M1 cellular modem with 5-year AT&T data plan
Circuit Breakers BRK-10A-2-240V BRK-15A-2-240V BRK-20A-2P-240V BRK-15A-2P-240V-B BRK-20A-2P-240V-B	Supports Eaton BR210, BR215, BR220, BR230, BR240, BR250, and BR260 circuit breakers. Circuit breaker, 2 pole, 10A, Eaton BR210 Circuit breaker, 2 pole, 15A, Eaton BR215 Circuit breaker, 2 pole, 20A, Eaton BR220 Circuit breaker, 2 pole, 15A, Eaton BR215B with hold down kit support Circuit breaker, 2 pole, 20A, Eaton BR220B with hold down kit support
XA-SOLARSHIELD-ES XA-PLUG-120-3	Replacement solar shield for IQ Combiner 4/4C Accessory receptacle for Power Line Carrier in IQ Combiner 4/4C (required for EPLC-01)
X-IQ-NA-HD-125A	Hold-down kit for Eaton circuit breaker with screws
Consumption monitoring CT (CT-200-SPLIT/CT-200-CLAMP)	A pair of 200A split core current transformers
ELECTRICAL SPECIFICATIONS	
Rating	Continuous duty
System voltage	120/240VAC, 60 Hz
Eaton BR series busbar rating	125A
Max. continuous current rating	65A
Max. continuous current rating (input from PV/storage)	64A
Max. fuse/circuit rating (output)	90A
Branch circuits (solar and/or storage)	Up to four 2-pole Eaton BR series Distributed Generation (DG) breakers only (not included)
Max. total branch circuit breaker rating (input)	80A of distributed generation/95A with IQ Gateway breaker included
IQ Gateway breaker	10A or 15A rating GE/Siemens/Eaton included
Production metering CT	200A solid core pre-installed and wired to IQ Gateway
MECHANICAL DATA	
Dimensions (WxHxD)	37.5 cm x 49.5 cm x 16.8 cm (14.75 in x 19.5 in x 6.63 in). Height is 53.5 cm (21.06 in) with mounting brackets.
Weight	7.5 kg (16.5 lbs)
Ambient temperature range	-40°C to +46°C (-40°F to 115°F)
Cooling	Natural convection, plus heat shield
Enclosure environmental rating	Outdoor, NRTL-certified, NEMA type 3R, polycarbonate construction
Wire sizes	• 20A to 50A breaker inputs: 14 to 4 AWG copper conductors • 60A breaker branch input: 4 to 1/0 AWG copper conductors • Main lug combined output: 10 to 2/0 AWG copper conductors • Neutral and ground: 14 to 1/0 copper conductors • Always follow local code requirements for conductor sizing.
Altitude	Up to 3,000 meters (9,842 feet)
INTERNET CONNECTION OPTIONS	
Integrated Wi-Fi	IEEE 802.11b/g/n
Cellular	CELLMODEM-M1-06-SP-05, CELLMODEM-M1-06-AT-05 (4G based LTE-M1 cellular modem). Note that an Mobile Connect cellular modem is required for all Enphase Energy System installations.
Ethernet	Optional, IEEE 802.3, Cat5E (or Cat6) UTP Ethernet cable (not included)
COMPLIANCE	
Compliance, IQ Combiner	CA Rule 21 (UL 1741-SA) IEEE 1547:2018 - UL 1741-SB, 3 rd Ed. (X2-IQ-AM1-240-4 and X2-IQ-AM1-240-4C) CAN/CSA C22.2 No. 107.1, Title 47 CFR, Part 15, Class B, ICES 003 Production metering: ANSI C12.20 accuracy class 0.5 (PV production) Consumption metering: accuracy class 2.5
Compliance, IQ Gateway	UL 60601-1/CANCSA 22.2 No. 61010-1

© 2022 Enphase Energy. All rights reserved. Enphase, the Enphase logo, IQ Combiner 4/4C, and other names are trademarks of Enphase Energy, Inc. Data subject to change.

IQ-C-4-4C-DS-0103-EN-US-12-29-2022



To learn more about Enphase offerings, visit enphase.com
IQ-C-4-4C-DS-0103-EN-US-12-29-2022



Ultra Rail

UR-40
UR-60

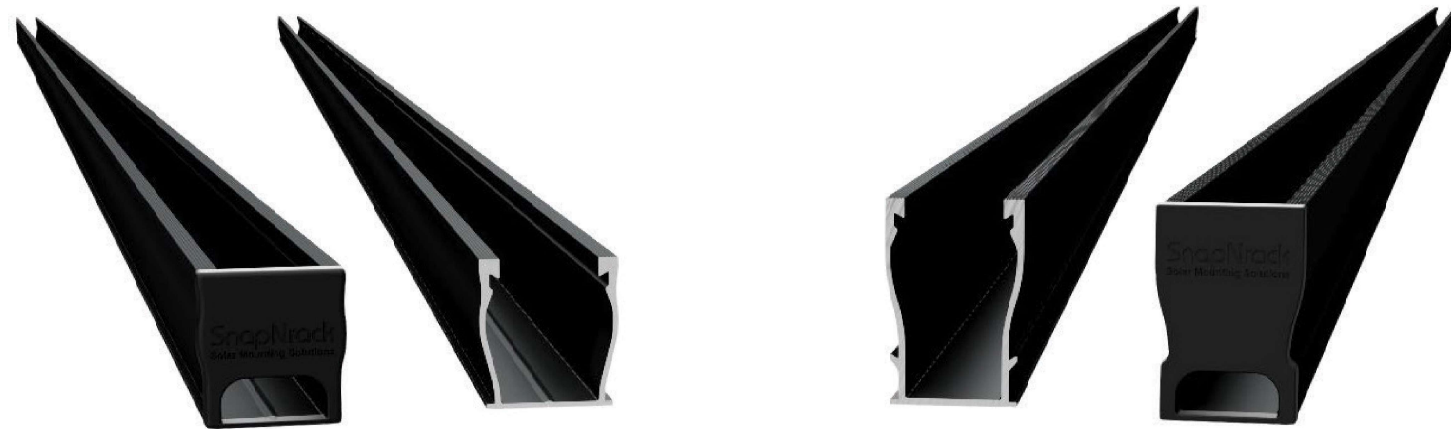

SnapNrack Ultra Rail System

A sleek, straightforward rail solution for mounting solar modules on all roof types. Ultra Rail features two rail profiles; UR-40 is a lightweight rail profile that is suitable for most geographic regions and maintains all the great features of SnapNrack rail, while UR-60 is a heavier duty rail profile that provides a larger rail channel and increased span capabilities. Both are compatible with all existing mounts, module clamps, and accessories for ease of install.

The Entire System is a Snap to Install

- New Ultra Rail Mounts include snap-in brackets for attaching rail
- Compatible with all the SnapNrack Mid Clamps and End Clamps customers love
- Universal End Clamps and snap-in End Caps provide a clean look to the array edge

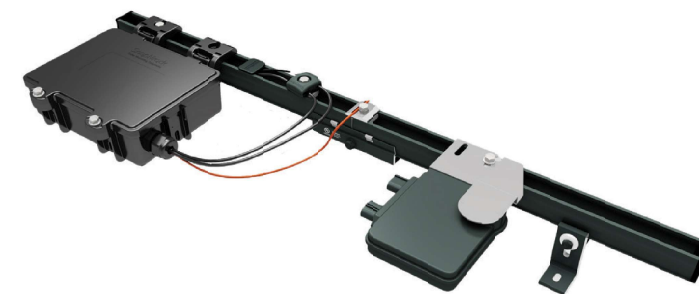

Unparalleled Wire Management

- Open rail channel provides room for running wires resulting in a long-lasting quality install
- Industry best wire management offering includes Junction Boxes, Universal Wire Clamps, MLPE Attachment Kits, and Conduit Clamps
- System is fully bonded and listed to UL 2703 Standard

The Ultimate Value in Rooftop Solar



Industry leading Wire Management Solutions



Mounts available for all roof types



Single Tool Installation



All SnapNrack Module Clamps & Accessories are compatible with both rail profiles

Start Installing Ultra Rail Today

RESOURCES
DESIGN
WHERE TO BUY

snapnrack.com/resources
snapnrack.com/configurator
snapnrack.com/where-to-buy

Heavy Duty UR-60 Rail

- UR-60 rail profile provides increased span capabilities for high wind speeds and snow loads
- Taller, stronger rail profile includes profile-specific rail splice and end cap
- All existing mounts, module clamps, and accessories are retained for the same great install experience



Quality. Innovative. Superior.

SnapNrack Solar Mounting Solutions are engineered to optimize material use and labor resources and improve overall installation quality and safety.

877-732-2860

www.snapnrack.com

contact@snapnrack.com

© 2019 by SnapNrack Solar Mounting Solutions. All rights reserved

DESCRIPTION: SNAPNRACK, ULTRA RAIL SPEEDSEAL™ FOOT	DRAWN BY: mwatkins	 595 MARKET STREET, 29TH FLOOR • SAN FRANCISCO, CA 94105 USA PHONE (415) 580-6900 • FAX (415) 580-6902 <small>THE INFORMATION IN THIS DRAWING IS CONFIDENTIAL AND PROPRIETARY. ANY REPRODUCTION, DISCLOSURE, OR USE THEREOF IS PROHIBITED WITHOUT THE WRITTEN CONSENT OF SUNRUN SOUTH LLC.</small>
PART NUMBER(S): 242-02163, 242-02167	REVISION: A	

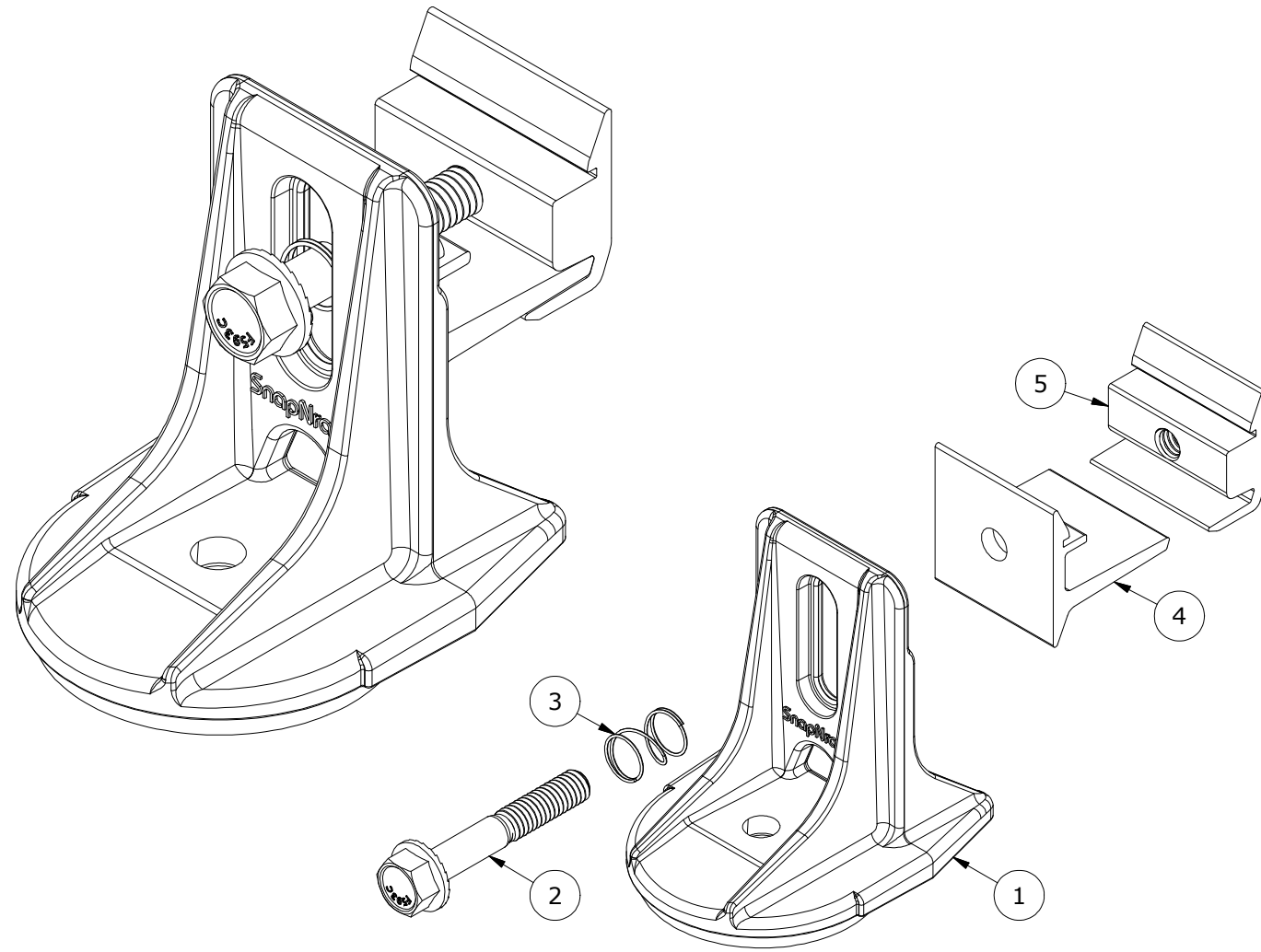

PARTS LIST		
ITEM	QTY	DESCRIPTION
1	1	SNAPNRACK, SPEEDSEAL FOOT, BASE, SEALING, SILVER / BLACK
2	1	BOLT, FLANGE, SERRATED, 5/16IN-18 X 2IN, SS
3	1	SNAPNRACK, RL UNIVERSAL, MOUNT SPRING, SS
4	1	SNAPNRACK, ULTRA RAIL MOUNT THRU PRC, CLEAR / BLACK
5	1	SNAPNRACK, ULTRA RAIL MOUNT TAPPED PRC, CLEAR / BLACK

MATERIALS:	DIE CAST A380 ALUMINUM, 6000 SERIES ALUMINUM, STAINLESS STEEL	
DESIGN LOAD (LBS):	802 UP, 1333 DOWN, 357 SIDE	OPTIONS:
ULTIMATE LOAD (LBS):	2118 UP, 4006 DOWN, 1331 SIDE	CLEAR / BLACK
TORQUE SPECIFICATION:	12 LB-FT	
CERTIFICATION:	UL 2703, FILE E359313; WIND-DRIVEN RAIN TEST FROM SUBJECT UL 2582	
WEIGHT (LBS):	0.45	

DESCRIPTION: SNAPNRACK, ULTRA RAIL SPEEDSEAL™ FOOT	DRAWN BY: mwatkins	 595 MARKET STREET, 29TH FLOOR • SAN FRANCISCO, CA 94105 USA PHONE (415) 580-6900 • FAX (415) 580-6902 <small>THE INFORMATION IN THIS DRAWING IS CONFIDENTIAL AND PROPRIETARY. ANY REPRODUCTION, DISCLOSURE, OR USE THEREOF IS PROHIBITED WITHOUT THE WRITTEN CONSENT OF SUNRUN SOUTH LLC.</small>
PART NUMBER(S): 242-02163, 242-02167	REVISION: A	

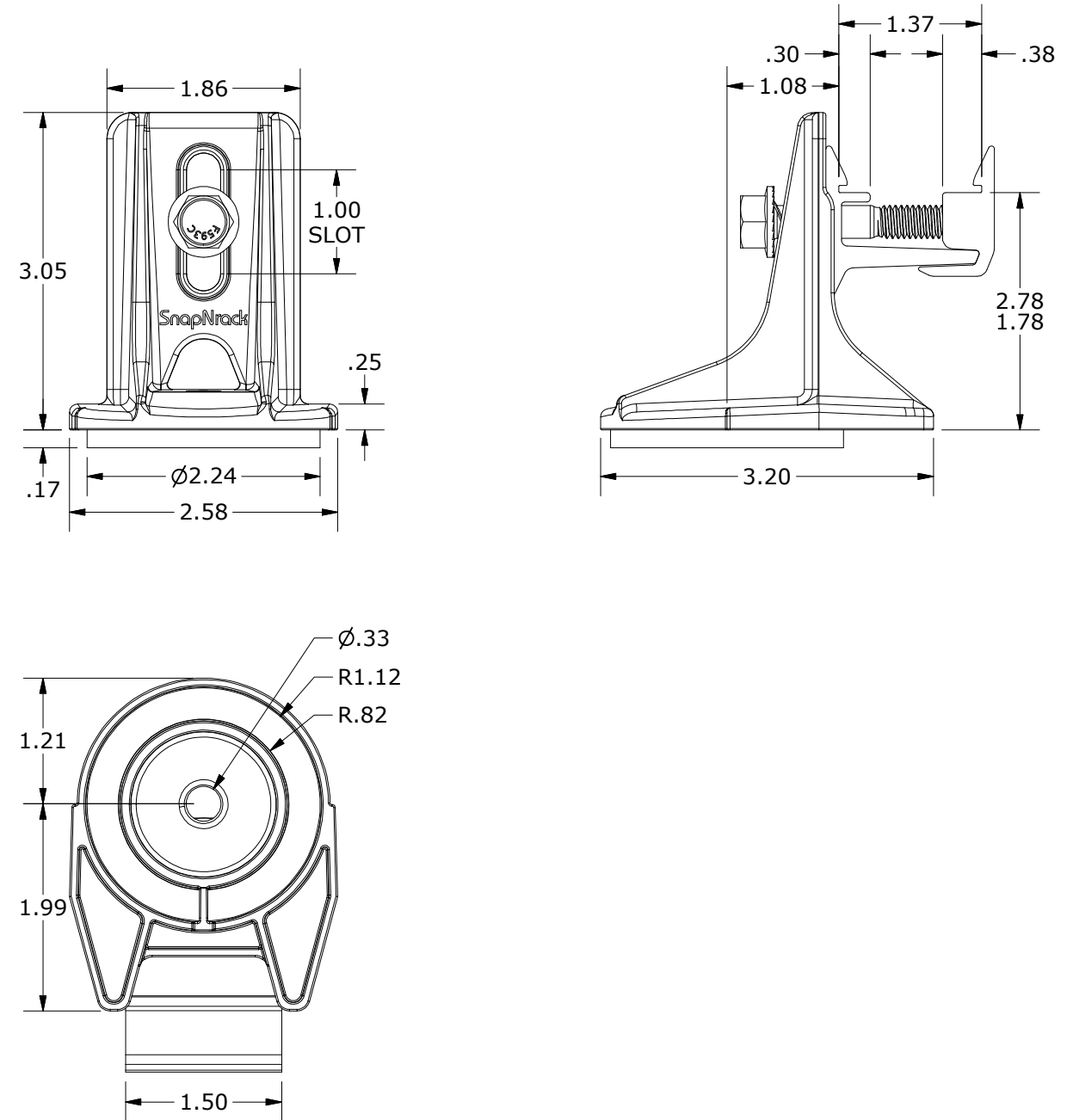

ALL DIMENSIONS IN INCHES

SnapNrack SpeedSeal™ Foot

Patent Pending Lag Driven Sealant Solution for Ultra Rail



A New Generation of Roof Attachments

- Innovative design incorporates flashing reliability into a single roof attachment
- 100% waterproof solution
- Sealing cavity with compressible barrier secures sealant in place & fills voids

Maintain the Integrity of the Roof by Eliminating Disruption

- Zero prying of shingles
- Zero removal of nails leaving holes in the roof
- Roof remains installed the way manufacturer meant it to be

Lag Driven Sealant Waterproofing

- Time Tested Roof Sealant provides lasting seal
- Sealant is compressed into cavity and lag hole as attachment is secured to rafter
- Active sealant solidifies bond if ever touched by liquid
- Technology passes UL 2582 Wind Driven Rain Test and ASTM E2140 Water Column Testing standards. Patent Pending.

Single Tool Installation

- SnapNrack was the first in the industry to develop a complete system that only requires a single tool. That tradition is continued as a ½” socket is still the only tool necessary to secure the mount as well as all other parts of the system.

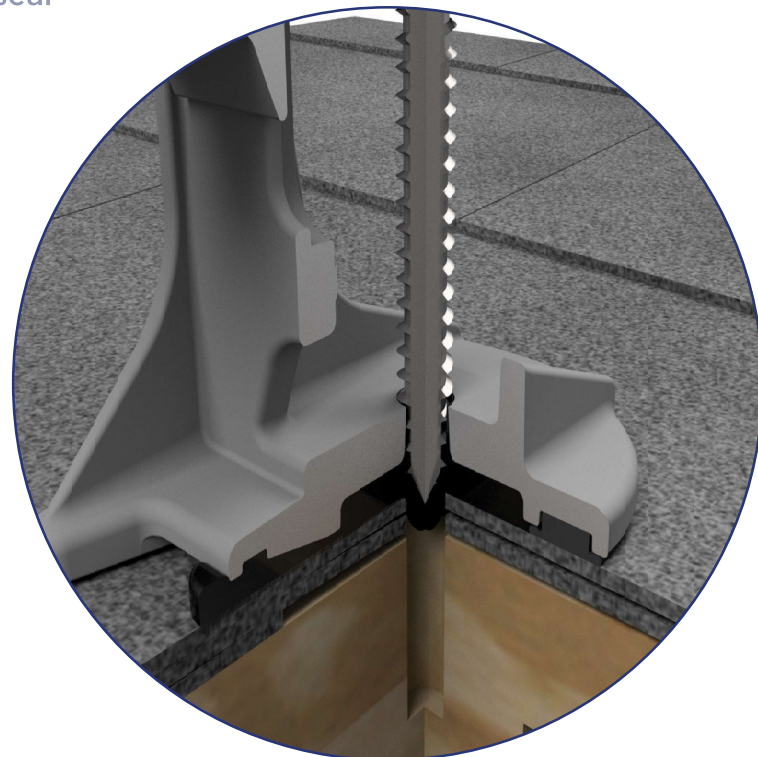

Note: Sealant shown in white for illustration purposes only.

SnapNrack SpeedSeal™ Foot

Fastest Roof Attachment in Solar

- Lag straight to a structural member, no in-between components such as flashings or bases.
- Simply locate rafter, fill sealant cavity & secure to roof. *It's that simple!*

Integrated Flashings. No Questions.

- Sealant fills around lag screw keeping roof and structure sealed and intact
- No added holes from ripping up nails, staples and screws holding shingles on roof

Less Time. Less Parts. Less Tools.

- No more need for a pry bar to rip up shingles
- No more proprietary lag screws
- Single Tool installation with ½” socket

Total System Solution One Tool. One Warranty.

- SnapNrack Ultra Rail is a straightforward intuitive install experience on the roof without compromising quality, aesthetics & safety, all supported by a 25 year warranty.
- Built-in Wire Management & Aesthetically pleasing features designed for Ultra Rail result in a long-lasting quality install that installers and homeowners love.

Certifications

SnapNrack Ultra Rail System has been evaluated by Underwriters Laboratories (UL) and Listed to UL/ANSI Standard 2703 for Mechanical Loading and Fire. Additionally it is listed to UL 2582 for wind-driven rain and ASTM 2140.

