

Project Details			
Name	patricia scardino	Date	03/15/2024
Location	1591 Oakridge Duncan Road, Fuquay-Varina, NC 27526	ASCE code	7.16
Total modules	28	Wind speed	110 mph
Module	Mission Solar Energy: MSE395SX9R (40mm)	Snow load	20 psf
Dimensions	Dimensions: 75.08" x 41.5" x 1.57" (1907.0mm x 1054.0mm x 40.0mm)	Wind exposure	C
Total watts	11,060 kW	Piers	10
		Concrete	2.84 yd ³

Inter sub-array spacing 148.0"
Calculated using solar azimuth of -45.39° and solar elevation of 15.29° at 9AM (America/New_York) on the winter solstice.



Substructure & Foundation			
Tilt	20°	South facing grade	0°
Pipe/tubing diameter	3"	Soil class	4
Foundation type	Concrete	Hole diameter	16"

Sub array #1					
Rows	4	Columns	7	# Arrays	1
Area	44' (EW) × 14' 1" (NS)	Rail type	XR1000	Diagonal bracing	no
E/W spacing	10' 6"	Rail cantilever	3' 9"	Pipe cantilever	1'
Piers/array	10	Total south piers	5 (6')	Total north piers	5 (9' 4")
Total cross pipes	2 (44')	Total pipe length	164' 7"		
Shear	1,034 lbs	Moment	2,584 ft-lbs	Uplift	-1,788 lbs

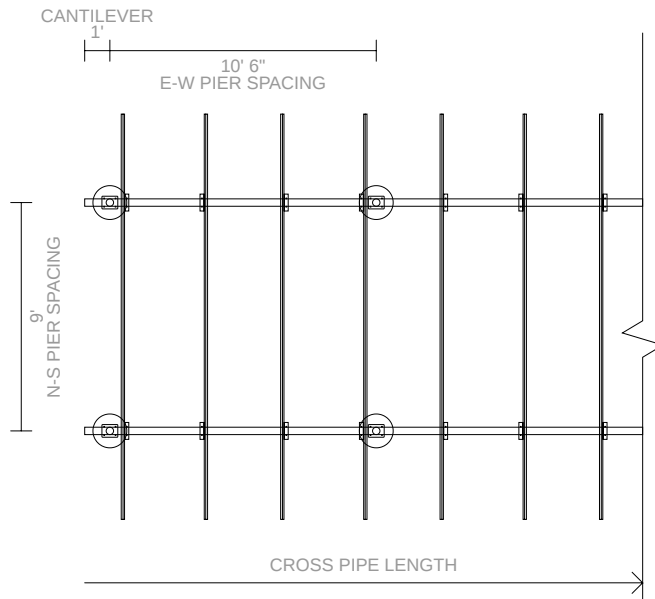
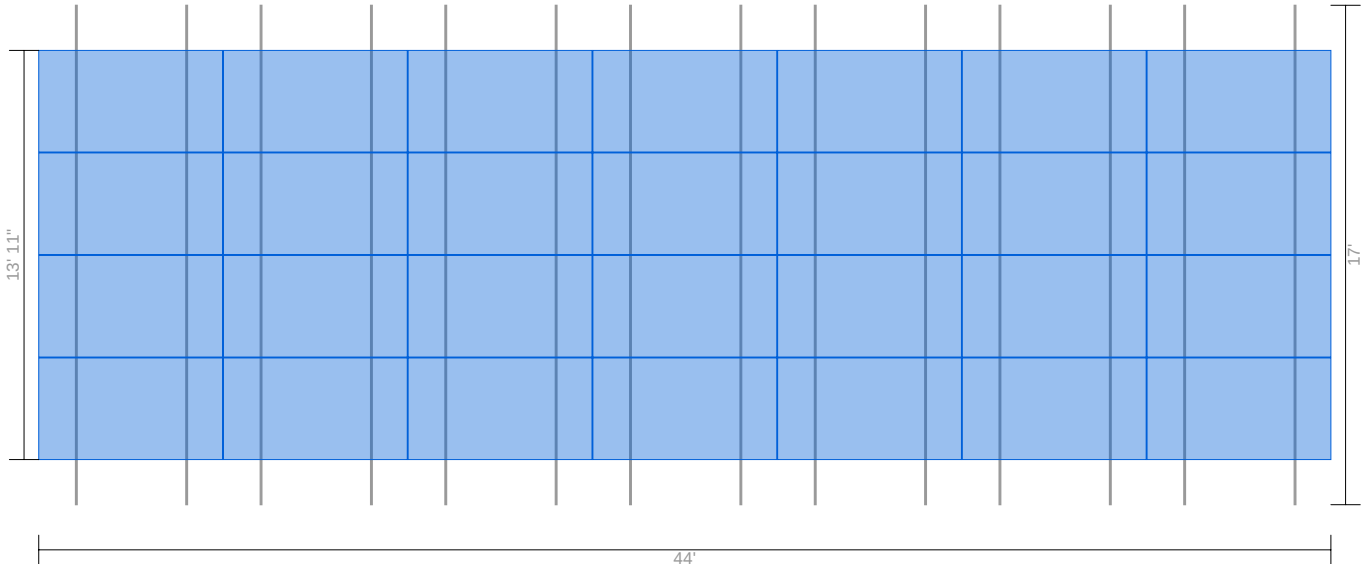

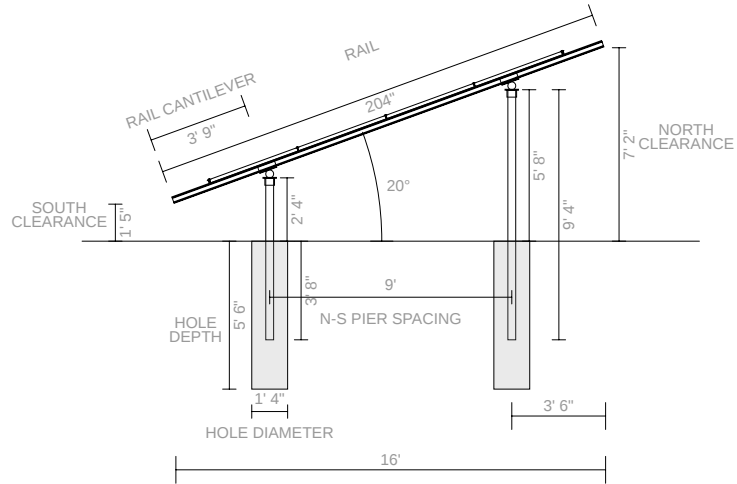

Pipe Fitting Detail

XR1000 Rail

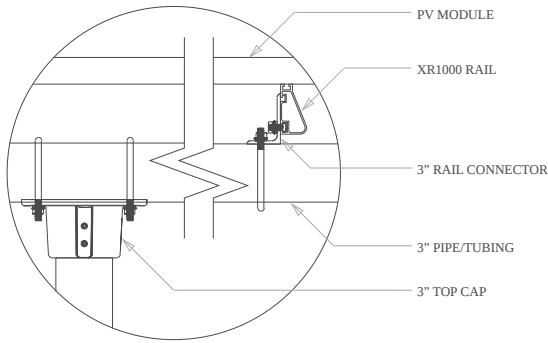

Front View

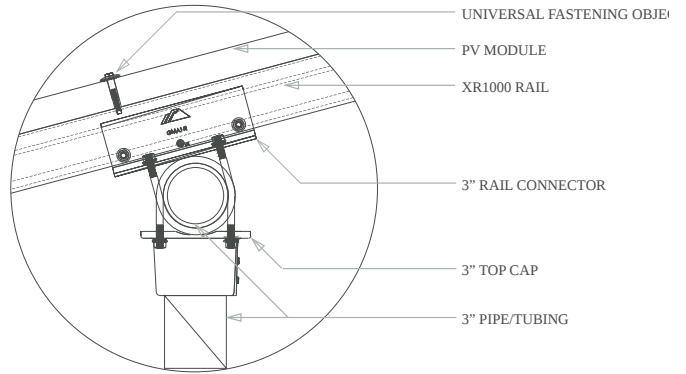

Side View

Clamp Detail

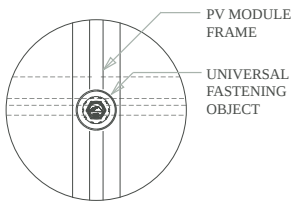

Mid Clamp, Plan

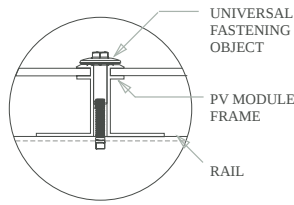

Mid Clamp, Front

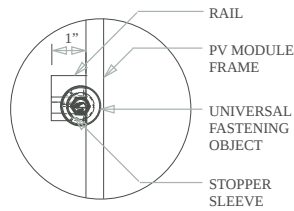

End Clamp, Plan

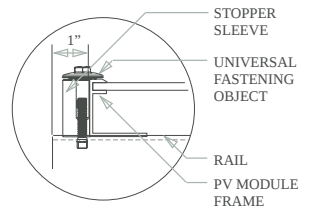

End Clamp, Front

Grounding Diagram

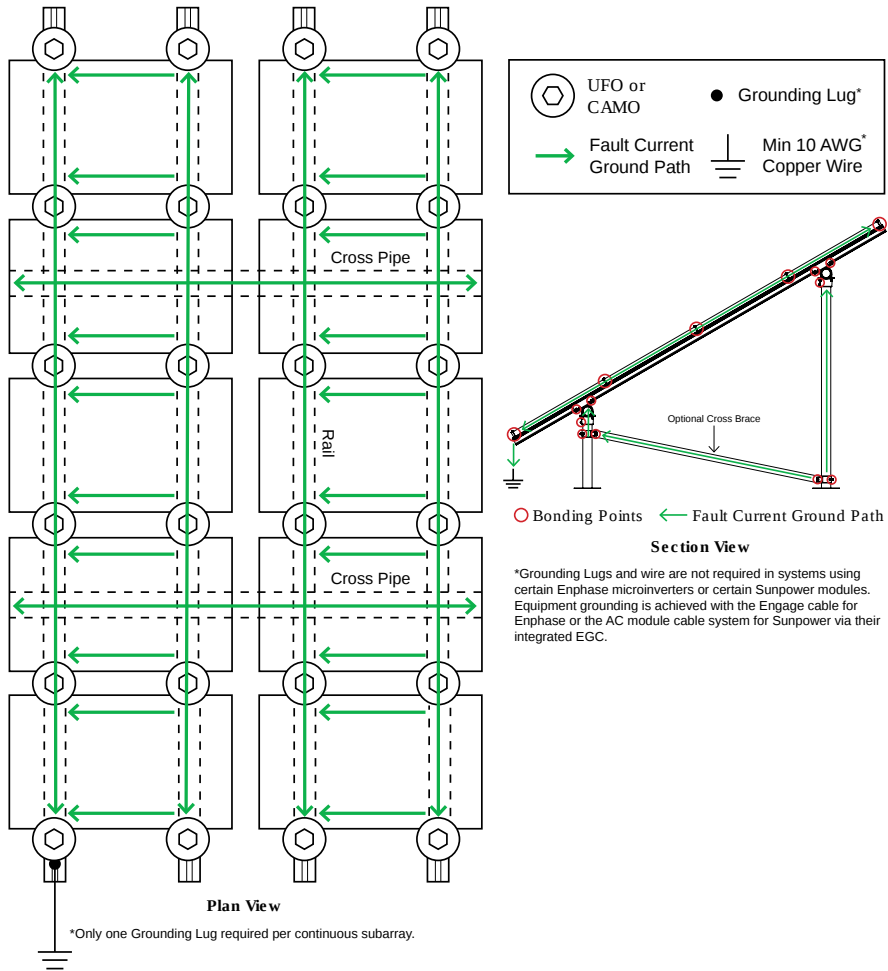

Bill of Materials

Part	Spares	Total Qty
-------------	---------------	------------------

Rails

XR-1000-204A XR1000, Rail 204" Clear	0	14
---	---	----

Clamps & Grounding

UFO-CL-01-A1 Universal Module Clamp, Clear	0	70
---	---	----

UFO-STP-40MM-M1 Stopper Sleeve, 40MM, Mill	0	28
---	---	----

XR-LUG-03-A1 Grounding Lug, Low Profile	0	1
--	---	---

Substructure

70-0300-SGA SGA Top Cap at 3"	0	10
----------------------------------	---	----

GM-BRC3-01-M1 Ground Mount Bonded Rail Connector - 3"	0	28
--	---	----

CHECKLIST

PRE-INSTALLATION

- Verify module compatibility. See [Page 14](#) for info.
- Purchase 2" or 3" Pipe or Mechanical Tubing

Pipe: 2" or 3" (NPS) ASTM A53 Grade B SCH 40 Pipe, galvanized to a min of ASTM A653 G90 or ASTM A123 G35.

Mechanical Tubing: 2.375" x 12 ga (O.D) or 3.500" x 8 ga (O.D.) Mechanical Tubing with one of the following Galvinizations (ASTM A1057).

- Allied Gatorshield
- Allied Flo-Coat Coating
- Wheatland ThunderCoat

TOOLS REQUIRED

- Post Hole Digger or Powered Auger
- Socket Drive (7/16", 9/16", 15/16" and 1/2" Sockets)
- Torque Wrenches (0-240 in-lbs and 10-40 ft-lbs)
- Transit, String Line, or Laser Level
- 3/16" Allen Head

TORQUE VALUES

Top Cap Set Screws (3/16" Allen Head)

- 2" or 3" NPS Schedule 40 Grade B Pipe: 20 ft-lbs
- 2.375" x 12 ga OD Mechanical Tubing: 11 ft-lbs
- 3.500" x 8 ga OD Mechanical Tubing: 16 ft-lbs
- For Ground Screw to Pipe Connection Hardware see [Page 5](#).
- Top Cap U-Bolt Nuts (9/16" Socket): 15 ft-lbs
- Rail Connector Bracket Nuts (9/16" Socket): 21 ft-lbs
- Rail Connector U-Bolt Nuts (9/16" Socket): 60 in-lbs
- Rail Grounding Lug Nut (7/16" Socket): 80 in-lbs
 - Rail Grounding Lug Terminal Screws (7/16" Socket): 20 in-lbs
- Module Grounding Lug Nut (3/8" Socket): 60 in-lbs
 - Module Grounding Lug Terminal Screws (1/2" Socket): 20 in-lbs
- Universal Fastening Objects (7/16" Socket): 80 in-lbs
- Diagonal Brace Set Screws (1/2" Socket): 15 ft-lbs
- Diagonal Brace Bolts (1/2" Socket): 40 ft-lbs
- Microinverter Kit Nuts (7/16" Socket): 80 in-lbs
- Frameless Module Kit Nuts (7/16" Socket): 80 in-lbs
- If using previous version of: Integrated Grounding Mid Clamps, Grounding Lug and End Clamps please refer to Alternate Components Addendum (Version 1.90).
- If installing on a low slope roof please refer to Ground Mount for Flat Roof Applications Addendum (Version 3.30).
- Unless otherwise noted, all components have been evaluated for multiple use. They can be uninstalled and reinstalled in the same or new location.

IRONRIDGE COMPONENTS

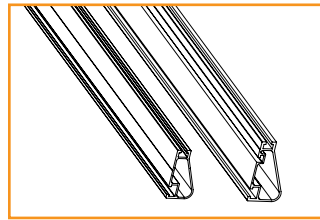

XR100 & XR1000 Rail

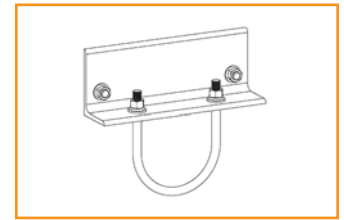

Rail Connector

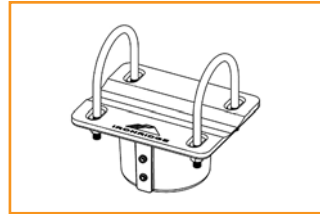

Top Cap



UFO (30-46mm)

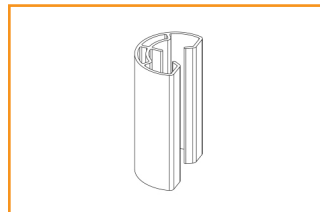

Stopper Sleeve



CAMO

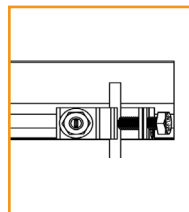

Rail Grounding Lug

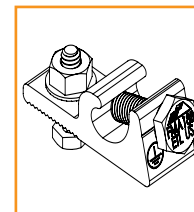

Module Grounding Lug

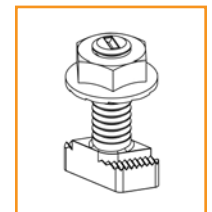

Microinverter Kit



Diagonal Brace



End Cap



Wire Clip

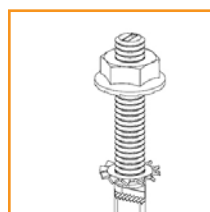

Frameless Module Kit

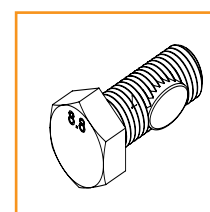

Hex Head Set Screw



Frameless End/Mid Clamp

Table 2B - MAXIMUM PIER SPACING (in) (APPLICABLE TO PANELS UP TO 80in)											
3" Unbraced Pipe Frame	Snow	Slope (deg)									
		Wind Speed & Exposure Category	psf	0	5	10	15	20	25	30	35
90 mph Exposure C	0	230	235	203	197	187	179	172	145	123	105
	10	200	203	187	184	181	179	172	145	123	105
	20	170	172	162	161	161	162	163	145	123	105
	30	159	161	153	152	153	155	157	145	123	105
	40	145	145	140	140	142	145	148	145	123	105
	50	131	131	131	130	133	137	141	145	123	105
95 mph Exposure C	60	121	121	121	123	126	130	134	141	123	105
	0	221	226	194	189	179	171	154	130	111	94
	10	196	199	181	179	175	171	154	130	111	94
	20	167	170	159	157	157	157	154	130	111	94
	30	157	159	150	149	150	151	152	130	111	94
	40	143	145	138	138	139	142	144	130	111	94
100 mph Exposure C	50	131	131	129	128	131	134	138	130	111	94
	60	121	121	121	121	124	128	132	130	111	94
	0	212	217	186	181	171	163	139	117	100	85
	10	191	194	176	174	170	163	139	117	100	85
	20	165	167	155	154	153	153	139	117	100	85
	30	155	156	147	146	146	147	139	117	100	85
105 mph Exposure C	40	142	143	136	135	137	139	139	117	100	85
	50	131	131	127	127	129	131	134	117	100	85
	60	121	121	120	119	122	125	129	117	100	85
	0	204	178	162	148	137	134	126	107	91	77
	10	186	178	162	148	137	134	126	107	91	77
	20	162	164	152	148	137	134	126	107	91	77
110 mph Exposure C	30	152	154	144	143	137	134	126	107	91	77
	40	140	141	134	133	134	134	126	107	91	77
	50	130	131	125	125	126	129	126	107	91	77
	60	121	121	118	118	120	123	126	107	91	77
	0	196	202	171	166	157	150	115	97	83	70
	10	182	185	167	164	157	150	115	97	83	70
120 mph Exposure C	20	159	161	149	147	145	145	115	97	83	70
	30	150	152	141	140	139	140	115	97	83	70
	40	138	139	131	130	131	132	115	97	83	70
	50	128	130	123	123	124	126	115	97	83	70
	0	183	188	159	154	145	132	97	82	69	59
	10	174	177	158	154	145	132	97	82	69	59
130 mph Exposure C	20	153	155	142	140	138	132	97	82	69	59
	30	145	147	136	134	133	132	97	82	69	59
	40	134	136	127	126	126	126	97	82	69	59
	50	125	127	119	119	120	121	97	82	69	59
	0	171	175	148	143	135	112	82	70	59	50
	10	166	169	148	143	135	112	82	70	59	50
140 mph Exposure C	20	147	150	136	134	131	112	82	70	59	50
	30	140	142	130	129	127	112	82	70	59	50
	40	130	132	122	121	121	112	82	70	59	50
	50	122	124	116	115	115	112	82	70	59	50
	0	160	165	138	134	126	97	71	60	51	43
	10	158	162	138	134	126	97	71	60	51	43
150 mph Exposure C	20	142	145	130	128	125	97	71	60	51	43
	30	135	138	125	123	121	97	71	60	51	43
	40	127	128	118	117	116	97	71	60	51	43
	50	119	121	112	111	111	97	71	60	51	43
	0	150	155	130	126	118	84	62	52	44	38
	10	150	154	130	126	118	84	62	52	44	38
160 mph Exposure C	20	137	140	125	123	118	84	62	52	44	38
	30	131	133	120	118	116	84	62	52	44	38
	40	123	125	114	113	111	84	62	52	44	38
	0	142	146	122	118	107	74	54	46	39	33
	10	142	146	122	118	107	74	54	46	39	33
	20	132	135	120	117	107	74	54	46	39	33
30	127	129	116	114	107	74	54	46	39	33	
40	119	121	110	108	107	74	54	46	39	33	

Notes: see page 38

Soil Class 4											
Table 4B - MINIMUM FOUNDATION DEPTHS (in)											
3" Pipe Frame Unbraced	Pier Dia (in)	Slope (deg)									
		0	5	10	15	20	25	30	35	40	45
Wind Speed & Exposure Category											
90 mph Exposure C	12	36	42	48	60	66	78	90	90	90	90
	16	36	36	42	54	60	72	78	78	78	78
	20	36	36	36	48	54	66	72	72	72	72
	24	36	36	36	42	54	60	66	66	66	66
95 mph Exposure C	12	42	48	48	60	72	78	90	90	90	90
	16	36	36	42	54	60	72	78	78	78	78
	20	36	36	36	48	60	66	72	72	72	72
	24	36	36	36	48	54	60	66	66	66	66
100 mph Exposure C	12	42	48	54	60	72	84	90	90	90	90
	16	36	36	42	54	66	72	78	78	78	78
	20	36	36	42	48	60	66	72	72	72	72
	24	36	36	36	48	54	60	66	66	66	66
105 mph Exposure C	12	42	48	48	60	66	78	90	90	90	90
	16	36	36	42	54	60	72	78	78	78	78
	20	36	36	42	48	54	66	72	72	72	72
	24	36	36	36	42	54	60	66	66	66	66
110 mph Exposure C	12	48	54	54	66	78	84	90	90	90	90
	16	36	42	48	54	66	78	78	78	78	78
	20	36	36	42	54	60	72	72	72	72	72
	24	36	36	36	48	54	66	66	66	66	66
120 mph Exposure C	12	54	60	60	72	78	90	90	90	90	90
	16	42	48	48	60	72	78	78	78	78	78
	20	36	36	42	54	66	72	72	72	72	72
	24	36	36	42	48	60	66	66	66	66	66
130 mph Exposure C	12	54	66	66	78	84	90	90	90	90	90
	16	42	48	54	60	72	78	78	78	78	78
	20	36	42	42	54	66	72	72	72	72	72
	24	36	36	42	54	60	66	66	66	66	66
140 mph Exposure C	12	60	72	72	84	84	90	90	90	90	90
	16	48	54	54	66	72	78	78	78	78	78
	20	36	42	48	60	66	72	72	72	72	72
	24	36	36	42	54	66	66	66	66	66	*
150 mph Exposure C	12	66	78	78	90	90	90	90	90	90	90
	16	48	60	60	66	78	78	78	78	78	78
	20	42	48	48	60	72	72	72	72	72	*
	24	36	42	42	54	66	66	66	66	*	*
160 mph Exposure C	12	72	84	84	96	96	90	90	90	90	90
	16	54	60	60	72	78	78	78	78	78	78
	20	42	48	48	60	72	72	72	72	*	*
	24	36	42	48	54	66	66	66	*	*	*

Notes: see page 76