

Lucent Engineering, P.C.

814 E 1475 N

Lehi, UT 84043

m: (309) 645-0999

admin@lucenteng.co

October 4, 2023

Encōr Solar, LLC
3049 Executive Pkwy, Ste 300
Lehi, UT 84043

RE: Engineering Services
Ross Residence
265 Old Montague Way, Cameron, NC
6.96 kW System
Solo Job #3982297

To Whom It May Concern,

We have reviewed the following information regarding the solar panel installation for this project. Alterations to these documents or plans shall not be made without direct written consent of the Engineer of Record.

A. Assumptions from Field Observation provided by Encōr Solar, LLC

The following structural design regarding the proposed alterations have been prepared from these assumptions. The verification of the field observations is the responsibility of the contractor. **Prior to commencement of work, the contractor shall verify the framing sizes, spacings, and spans noted in the sealed plans, calculations, and/or certification letter and notify the Engineer of Record of any discrepancies.**

	<u>Roof</u>
Roof Finish :	Asphalt Shingle
Roof Underlayment :	OSB
Roof Profile :	Gable
Roof Structural System :	Metal Plate Trusses
Truss Top Chord/Setup :	2 x 4 / Attic
Chord/Rafter Wood Grade :	Southern Pine #2 or better
Truss/Rafter Spacing :	24" o.c.
Roof Slope :	37 deg
Max Top Chord/Rafter Span :	6.25 ft
Bearing Wall Type :	Convl Lt-Frame Constr
Foundation :	Permanent Concrete
Stories :	Two

B. Building Design Criteria

Code :	2018 NCRC (ASCE 7-10)	Risk Category :	II
Roof Live Load :	20 psf (0 psf at panels)	Occupancy Class :	R-3
Ground Snow Load :	10 psf	Roof Dead Load :	6.5 psf
Ult Wind Speed :	120 mph	PV Dead Load :	3 psf
Exposure Category :	C	Total Dead Load :	9.5 psf

C. Summary of Existing Structure Results

Roof

After review of the field observations and based on our calculations and in accordance with the applicable building codes and current industry standards, the existing roof structure supporting the proposed alterations consisting of the solar array has been determined to be:

- Adequate to support the additional imposed loads. **No structural upgrades are required.**

D. Solar Panel Support Bracket Anchorage

1. Solar panels shall be designed, mounted, and installed in accordance with the most recent "UniRac Manual", which can be found on the UniRac website (<http://unirac.com/>).
2. Manufacturer's Panel Bracket Connection to Roof Chord/Rafter Member:

Fastener : (1) 5/16" Lag Screw per Bracket
NDS Withdrawl Value : 307 lbs/inch
Min. Thread Length and Penetration Depth : 2.5"

3. Considering the existing roof's slope, size, spacing, condition, and calculated loads, the panel bracket supports shall be placed no greater than 48 in. o/c.
4. Panel supports connections shall be staggered to distribute load to adjacent trusses.

E. Overall Summary

Based on the information supplied to us at the time of this report, on the evaluation of the existing structure, and solar array panel bracket connection, it is our opinion that the roof system will adequately support the additional loads imposed by the solar array. This evaluation conforms to 2018 NCRC and current industry standards.

Should you have any questions regarding this letter or if you require further information, do not hesitate to contact me.

Sincerely,

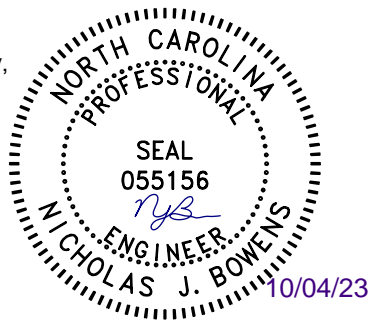

Nicholas J. Bowens, PE
License No. 55156

Limits of Scope of Work and Liability

The existing structure is assumed to have been designed and constructed following appropriate codes at the time of erection and assumed to have appropriated permits. The calculations performed are only for the roof framing supporting the solar array installation referenced in the stamped plans and were completed according to generally recognized structural analysis standards and procedures, professional engineering, and design experience opinions and judgements. Existing deficiencies which are unknown or were not observed during the time the site observation are not included in this scope of work. All solar panel modules, racking, and mounting equipment shall be designed and installed per the manufacturer's approved installation specifications. The Engineer of Record and the engineering consulting firm assume no responsibility for misuse or improper installation. This analysis is not stamped for water leakage. Framing was determined on information in provided plans and/or photos, along with engineering judgement. Prior to commencement of work, the contractor shall verify the framing sizes, spacings, and spans noted in the stamped plans, calculations, and/or certification letter and notify the Engineer of Record of any discrepancies prior to starting construction. If during solar panel installation, the roof framing members appear unstable or deflect non-uniformly, our office should be notified before proceeding with the installation. The contractor shall also verify that there are no damage/deficiencies (i.e., dry rot, water damage, termite damage, framing member/connection damage, etc.) to framing that was not addressed in the stamped plans, calculations, and/or certification letter and notify the Engineer of Record of any concerns prior to starting construction.

NEC Standard Load Calculation for Single Family Dwellings For Service Ratings of 120/240V,200A Max			
ERIC KOSS 265 Old Montague Way, Cameron, NC 28326			
General Lighting/Power Load			
Description of Load	QTY	Volt-Amps (Wattage) Per Load	Total Volt-Amps (Wattage) Used
Kitchen Appliance Branch Circuits	2	1500	3000
Laundry Circuits	1	1500	1500
Appliances & Equipment Excluding Air Conditioner(s)			
Microwave	1	1500	1500
Trash Compactor	0	0	0
Dish Washer	1	2880	2880
Disposal	1	700	700
Oven	0	0	0
Electric Range	1	7680	7680
Induction Range	0	0	0
Clothes Dryer	0	0	0
Clothes Washer	1	500	500
Tankless Water Heater	0	0	0
Electric Water Heater	0	0	0
Pool or Spa	0	0	0
Evaporator Cooler	1	550	550
Electric Vehicle Supply Equipment (EVSE)	0	0	0
Other	1	5760	5760
Other	1	5760	5760
Other	0	0	0
Calculations of All Appliances and Lighting Excluding Air Conditioner(s)			
Total Square Footage of Building: 2900 ft ² X 3 = 8700 Total Volt Amps (Wattage) of All Loads: 29830 W + 8700 = 38530 W 38530 W - 10000 = 28530 W 28530 W X .40 = 11412 W 11412 W + 10000 = 21412 W			
Heating and Air Conditioning			
Description of Load	Total Volt-Amps (Wattage) Used		
AC & Cooling	7680		
Heating	11520		
Heat Pump	0		
Space Heat, 4 Separate Units	0		
Space Heat, > 4 Units	0		
Thermal Storage & Other	0		
Total Home Calculations			
Largest HVAC Load: 11520 W Grand Total of All Loads: 21412 W + 11520 W = 32932 W 32932 W / 240 V = 137.22 A			
RATING OF EXISTING/PROPOSED ELECTRICAL SERVICE MAIN BREAKER (AMPS) =			150 A
TOTAL MINIMUM SIZE (AMPS) REQUIRED FOR MAIN SERVICE DISCONNECT =			137.22 A
PASS			

AERIAL VIEW

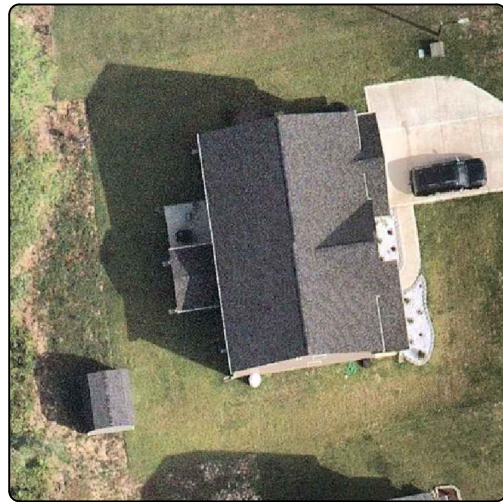

STREET VIEW



SHEET INDEX

- PV01 COVER
- PV02 SITE PLAN
- PV03 ROOF PLAN
- PV04 MOUNTING DETAIL
- PV05 LINE DIAGRAM
- PV06 ELECTRICAL CALCS
- PV07 LABELS
- PV08 PLACARD
- PV09 SITE PHOTOS

GENERAL NOTES

1. INSTALLATION OF SOLAR PHOTOVOLTAIC SYSTEM SHALL BE IN ACCORDANCE WITH NEC ARTICLE 690, AND ALL OTHER APPLICABLE NEC CODES WHERE NOTED OR EXISTING
2. PROPER ACCESS AND WORKING CLEARANCE AROUND EXISTING AND PROPOSED ELECTRICAL EQUIPMENT WILL COMPLY WITH NEC ARTICLE 110
3. ALL WIRES, INCLUDING THE GROUNDING ELECTRODE CONDUCTOR SHALL BE PROTECTED FROM PHYSICAL DAMAGE IN ACCORDANCE WITH NEC ARTICLE 250
4. THE PV MODULES ARE CONSIDERED NON-COMBUSTIBLE; THIS SYSTEM IS UTILITY INTERACTIVE PER UL 1741
5. ALL DC WIRES SHALL BE SIZED ACCORDING TO [NEC 690.8]
6. DC CONDUCTORS SHALL BE WITHIN PROTECTED RACEWAYS IN ACCORDANCE WITH [NEC 690.31]
7. ALL SIGNAGE TO BE PLACED IN ACCORDANCE WITH LOCAL JURISDICTIONAL BUILDING CODE

PHOTOVOLTAIC (PV) SYSTEM SPECIFICATIONS

ELECTRICAL EQUIPMENT

- PV MODULES:
 (24) HANWHA Q.PEAK DUO BLK ML-G10+ 400
 DC SYSTEM SIZE: 9.6 KW DC
- INVERTER(S):
 (24) ENPHASE IQ8PLUS-72-2-US INVERTER(S)
 AC SYSTEM SIZE: 6.96 KW AC
- (1) TESLA POWERWALL 2 BATTERIES

RACKING

- RACKING: K2 CROSSRAIL 48-XL
 ATTACHMENT: UNIRAC - FLASHKIT PRO

APPLICABLE GOVERNING CODES

- 2020 NATIONAL ELECTRICAL CODE
 2018 NORTH CAROLINA STATE BUILDING CODE: RESIDENTIAL
 2018 NORTH CAROLINA STATE BUILDING CODE: BUILDING
 2018 NORTH CAROLINA STATE BUILDING CODE: FIRE

SITE SPECIFICATIONS

- OCCUPANCY: R-3
 ZONING: RESIDENTIAL

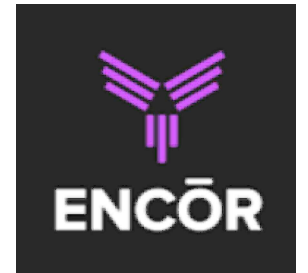

CONTRACTOR INFORMATION:

ENCOR SOLAR, LLC
 3049 Executive Parkway
 Suite 300
 Lehi, UT 84043
 License # U.35743

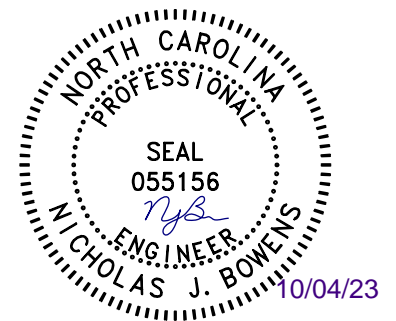

SITE INFORMATION

ERIC ROSS

265 OLD MONTAGUE WAY
 CAMERON, NC 28326

AC SYSTEM SIZE: 6.96 KW AC

DC SYSTEM SIZE: 9.6 KW DC

LAT, 35.2674021

LONG, -79.0209114

(24) HANWHA Q.PEAK DUO BLK ML-G10+ 400
 PV MODULES

(24) ENPHASE IQ8PLUS-72-2-US INVERTER(S)

CENTRAL ELECTRIC MEMBERSHIP CORP

DRAWN BY: SoloCAD

10/4/2023

COVER - PV01

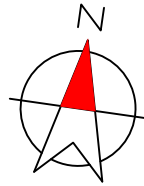

ARRAY DETAILS:		
MOUNTING PLANE:	AZIMUTH:	TILT:
MP1	242°	37°

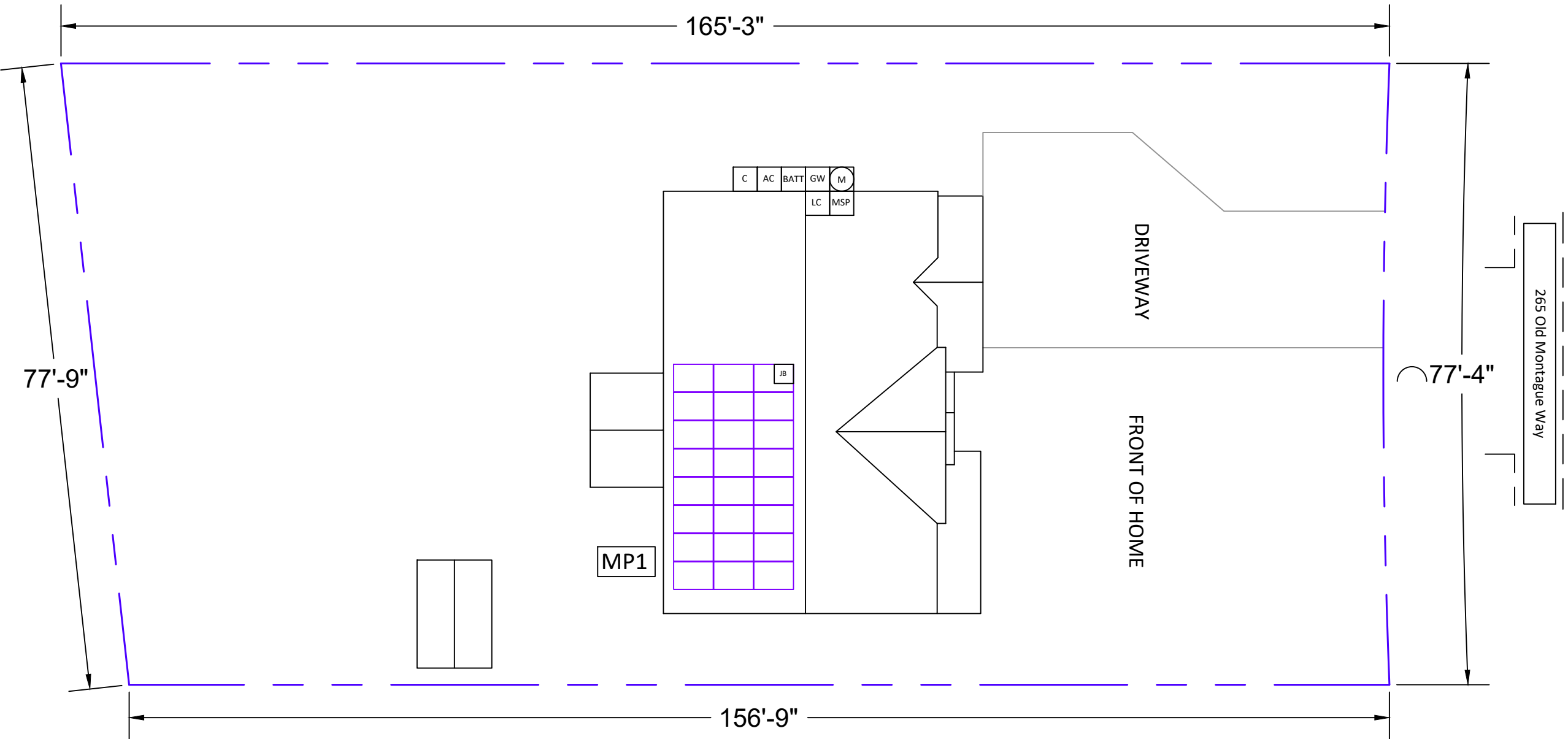

CONTRACTOR INFORMATION:
 ENCOR SOLAR, LLC
 3049 Executive Parkway
 Suite 300
 Lehi, UT 84043
 License # U.35743

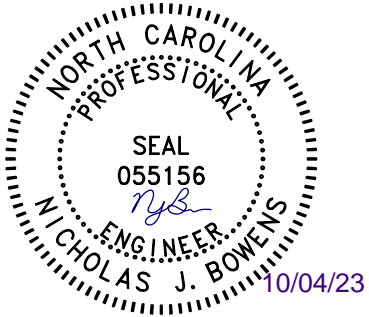

SITE INFORMATION

ERIC ROSS
 265 OLD MONTAGUE WAY
 CAMERON, NC 28326
 AC SYSTEM SIZE: 6.96 KW AC
 DC SYSTEM SIZE: 9.6 KW DC
 LAT, 35.2674021
 LONG, -79.0209114
 (24) HANWHA Q.PEAK DUO BLK ML-G10+ 400 PV MODULES
 (24) ENPHASE IQ8PLUS-72-2-US INVERTER(S)

CENTRAL ELECTRIC MEMBERSHIP CORP

DRAWN BY: SoloCAD

10/4/2023

SITE PLAN - PV02

EQUIPMENT LEGEND:

- M UTILITY METER
- AC VISIBLE, LOCKABLE, LABELED AC DISCONNECT
- INV INVERTER
- SUB SUB PANEL
- GP GENERATION PANEL
- SD SERVICE DISCONNECT
- | PROPERTY LINE
- PV MODULES
- MSP MAIN SERVICE PANEL
- PV METER SOCKET (FOR UTILITY PV METER)
- C COMBINER BOX
- LC LOAD CENTER
- GW TESLA GATEWAY
- BATT BATTERY(IES)
- JB JUNCTION BOX
- FIRE ACCESS PATHWAY (3' TYP)

VISIBLE, LOCKABLE, LABELED AC DISCONNECT LOCATED WITHIN 10' OF UTILITY METER

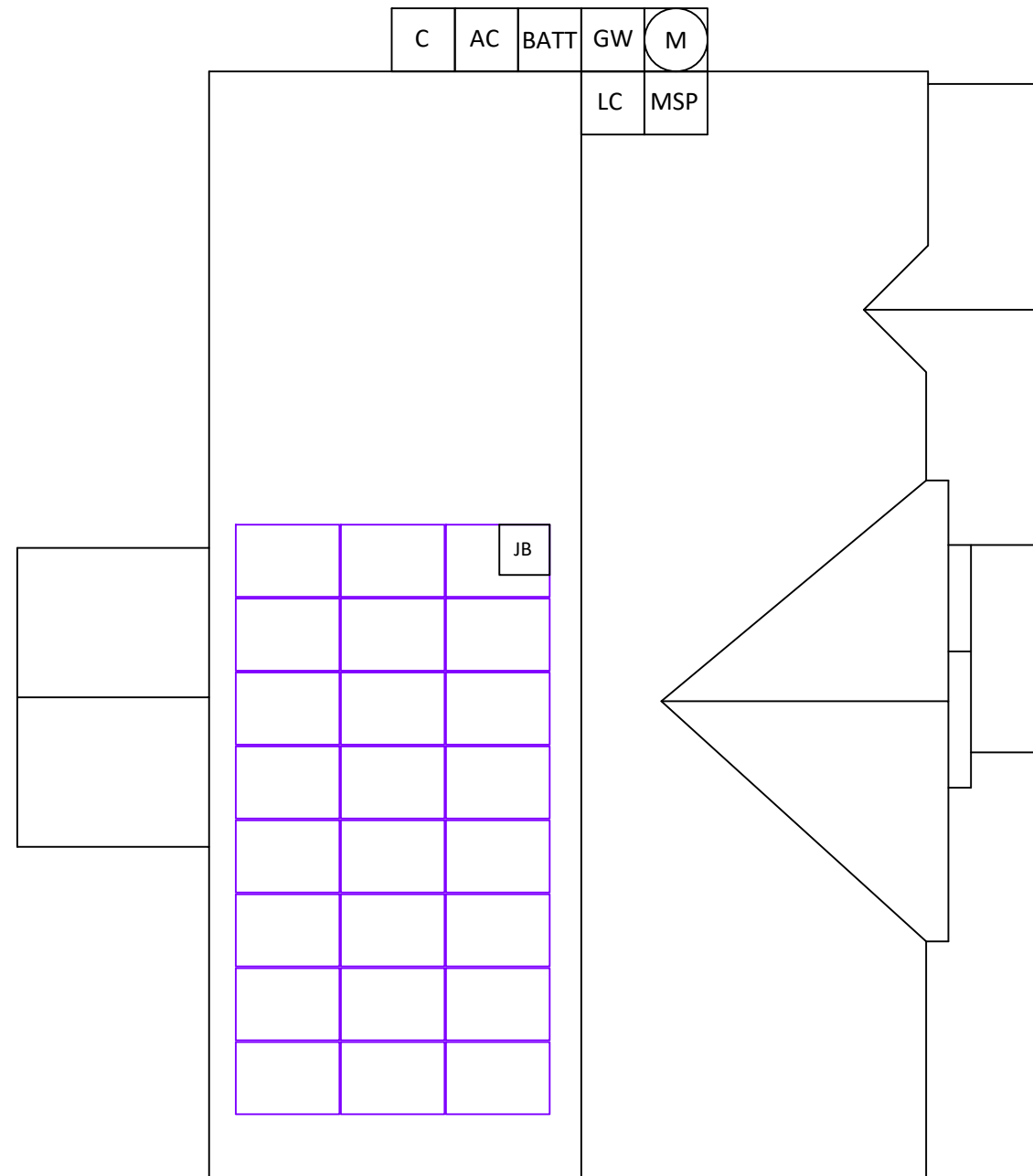
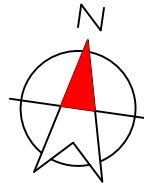

CONTRACTOR INFORMATION:
 ENCOR SOLAR, LLC
 3049 Executive Parkway
 Suite 300
 Lehi, UT 84043
 License # U.35743

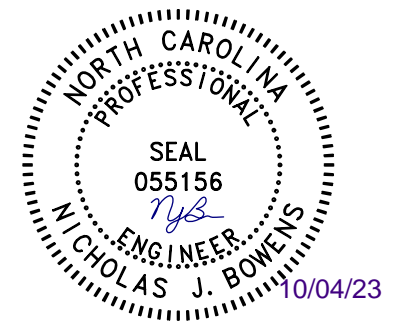

SITE INFORMATION

ERIC ROSS
 265 OLD MONTAGUE WAY
 CAMERON, NC 28326
 AC SYSTEM SIZE: 6.96 KW AC
 DC SYSTEM SIZE: 9.6 KW DC
 LAT, 35.2674021
 LONG, -79.0209114
 (24) HANWHA Q.PEAK DUO BLK ML-G10+ 400 PV MODULES
 (24) ENPHASE IQ8PLUS-72-2-US INVERTER(S)

CENTRAL ELECTRIC MEMBERSHIP CORP

DRAWN BY: SoloCAD

10/4/2023

ROOF PLAN - PV03

EQUIPMENT INFORMATION:		ROOF INFO:		PHOTOVOLTAIC ARRAY STRUCTURAL CRITERIA:	
RACKING MANUFACTURER:	K2	ROOF TYPE:	ASPHALT SHINGLE	PV MODULE COUNT:	24
RACKING PART NUMBER:	CROSSRAIL 48-XL	ROOF FRAMING:	MANUFACTURED TRUSS	ARRAY AREA:	MODULE COUNT * 21.14 FT ² = 507.36
ATTACHMENTS	UNIRAC - FLASHKIT PRO	RAFTER/TOP CHORD SIZE:	2x4	ROOF AREA:	2173 FT ²
ATTACHMENT QTY:	48	RAFTER/TOP CHORD SPACING:	24"	PERCENT OF ROOF COVERED:	23%
SPLICE QTY:	12	ATTACHMENT SPACING:	48"	ARRAY WEIGHT:	MODULE COUNT * 49 LBS = 1176 LBS
MIDCLAMP QTY:	42			POINT LOAD:	ARRAY LBS/ATTACHMENTS = 24.5
ENDCLAMP QTY:	12			DISTRIBUTED LOAD: (lbs/ft ²)	ARRAY WEIGHT/AREA = 2.32 LBS/FT ²

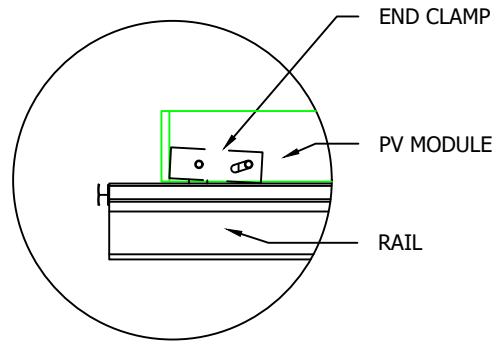

1 END CLAMP DETAILS

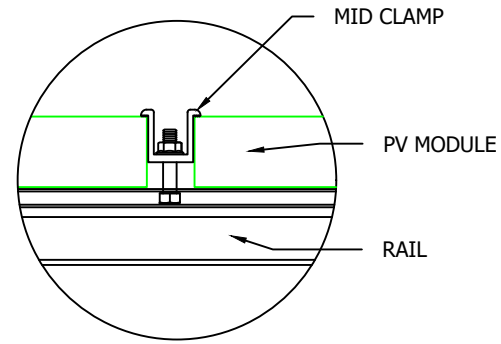

2 MID CLAMP DETAILS

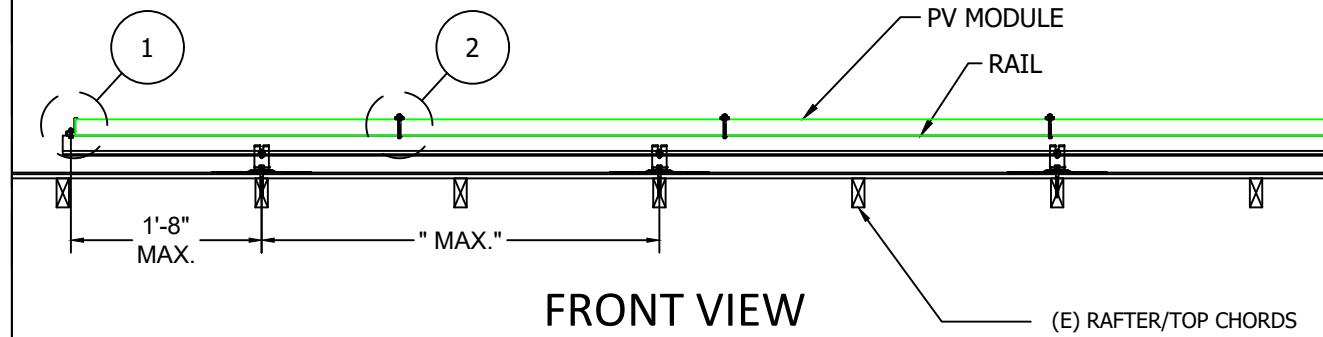

FRONT VIEW

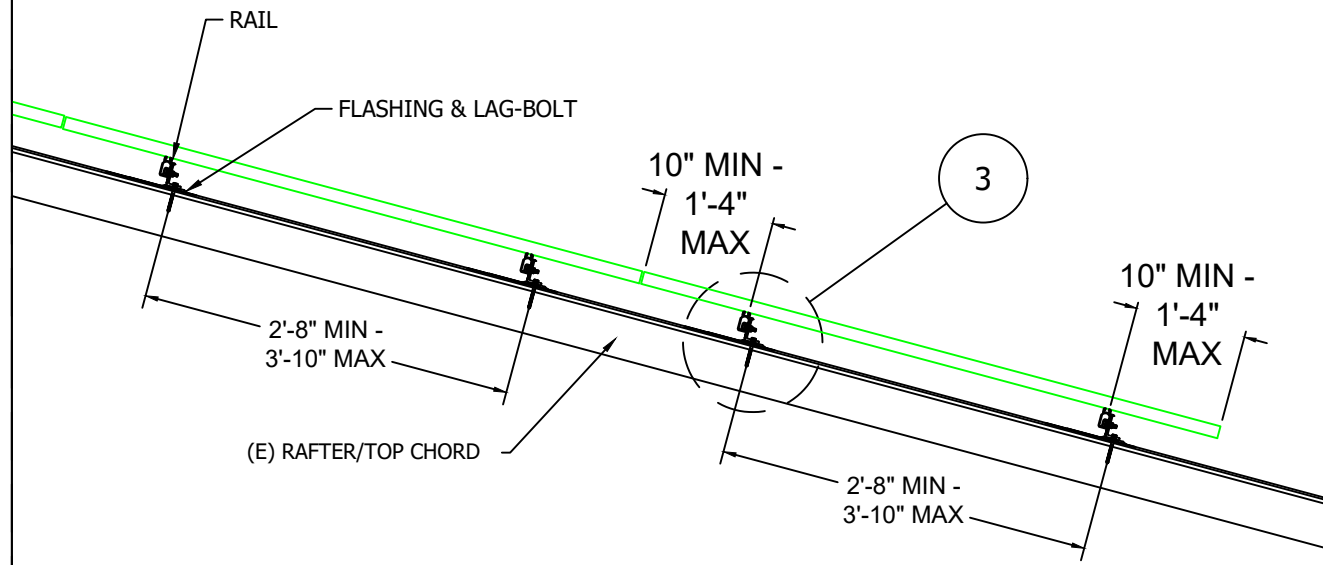

SIDE VIEW

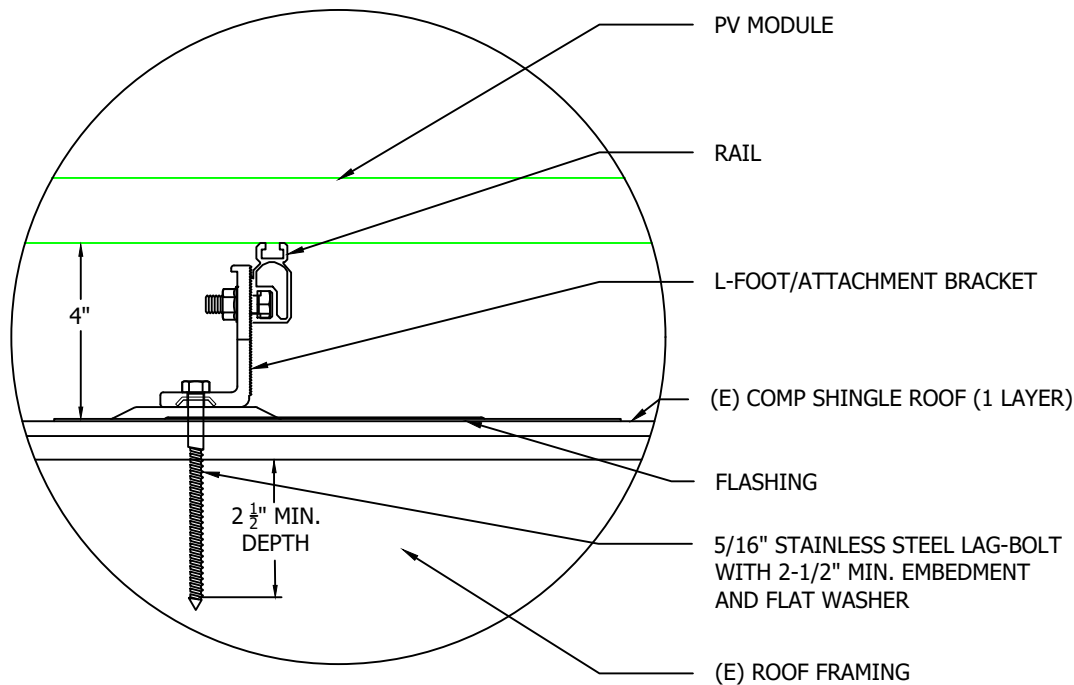

3 DETAIL, MOUNTING AND FLASHING



CONTRACTOR INFORMATION:
ENCOR SOLAR, LLC
 3049 Executive Parkway
 Suite 300
 Lehi, UT 84043
 License # U.35743

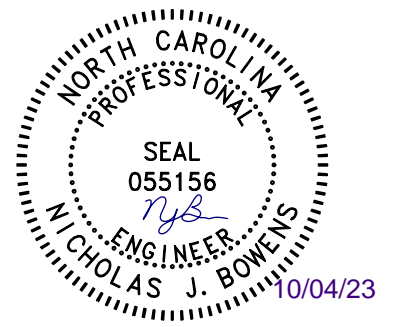

SITE INFORMATION

ERIC ROSS
 265 OLD MONTAGUE WAY
 CAMERON, NC 28326
 AC SYSTEM SIZE: 6.96 KW AC
 DC SYSTEM SIZE: 9.6 KW DC
 LAT, 35.2674021
 LONG, -79.0209114
 (24) HANWHA Q.PEAK DUO BLK ML-G10+ 400 PV MODULES
 (24) ENPHASE IQ8PLUS-72-2-US INVERTER(S)

CENTRAL ELECTRIC MEMBERSHIP CORP

DRAWN BY: SoloCAD

10/4/2023

MOUNTING DETAIL - PV04

EQUIPMENT INFORMATION:		ROOF INFO:		PHOTOVOLTAIC ARRAY STRUCTURAL CRITERIA:	
RACKING MANUFACTURER:	K2	ROOF TYPE:	ASPHALT SHINGLE	PV MODULE COUNT:	24
RACKING PART NUMBER:	CROSSRAIL 48-XL	ROOF FRAMING:	MANUFACTURED TRUSS	ARRAY AREA:	MODULE COUNT * 21.14 FT ² = 507.36
ATTACHMENTS	UNIRAC - FLASHKIT PRO	RAFTER/TOP CHORD SIZE:	2x4	ROOF AREA:	2173 FT ²
ATTACHMENT QTY:	48	RAFTER/TOP CHORD SPACING:	24"	PERCENT OF ROOF COVERED:	23%
SPLICE QTY:	12	ATTACHMENT SPACING:	48"	ARRAY WEIGHT:	MODULE COUNT * 49 LBS = 1176 LBS
MIDCLAMP QTY:	42			POINT LOAD:	ARRAY LBS/ATTACHMENTS = 24.5
ENDCLAMP QTY:	12			DISTRIBUTED LOAD: (lbs/ft ²)	ARRAY WEIGHT/AREA = 2.32 LBS/FT ²

HANWHA Q.PEAK DUO BLK ML-G10+ 400 SPECS	
POWER MAX (P _{MAX}):	400 W
OPEN CIRCUIT VOLTAGE (V _{OC}):	45.3 V
MAX POWER-POINT CURRENT (I _{MP}):	10.77 A
MAX POWER-POINT VOLTAGE (V _{MP}):	37.13 V
SHORT CIRCUIT CURRENT (I _{SC}):	11.14 A
SERIES FUSE RATING:	20A

ENPHASE IQ8PLUS-72-2-US SPECS	
MAX INPUT VOLTAGE:	60 V
MAX DC SHORT CIRCUIT CURRENT:	15 A
MAXIMUM OUTPUT POWER:	290 W
MAXIMUM OUTPUT CURRENT:	1.21 A
NOM. OUTPUT VOLTAGE:	240 V
MAX UNITS PER 20A CIRCUIT:	13
1-PHASE, 60 HZ, UL 1741 LISTED	

EQUIPMENT SCHEDULE			
TYPE	QTY	DESCRIPTION	RATING
MODULES:	(24)	HANWHA Q.PEAK DUO BLK ML-G10+ 400	400 W
INVERTERS:	(24)	ENPHASE IQ8PLUS-72-2-US	290 W
AC DISCONNECT(S):	(1)	PV AC DISCONNECT, 240V, 2-POLE	60 A
AC COMBINER:	(1)	ENPHASE (X2-IQ-AM1-240-4)	125 A
ENERGY STORAGE:	(1)	TESLA POWERWALL 2	14 kWh

CONDUIT & CONDUCTOR SCHEDULE				
TAG	QTY	WIRE GAUGE	DESCRIPTION	CONDUIT SIZE
1	(2)	12-2	ENPHASE Q-CABLE COPPER - (L1, L2)	N/A - FREE AIR
	(1)	6 AWG	BARE COPPER - (GROUND)	
2	(2)	10 AWG	THHN/THWN-2 COPPER - (L1, L2)	3/4" EMT
	(1)	10 AWG	THWN-2 COPPER - (GROUND)	
3	(4)	10 AWG	THHN/THWN-2 COPPER - (L1, L2)	3/4" EMT
	(1)	10 AWG	THWN-2 COPPER - (GROUND)	
4	(3)	8 AWG	THWN-2 COPPER - (L1, L2, NEUTRAL)	3/4" EMT
	(1)	10 AWG	THWN-2 COPPER - (GROUND)	
5	(3)	2 AWG	THWN-2 COPPER - (L1, L2, NEUTRAL)	1.25" EMT
	(1)	8 AWG	THWN-2 COPPER - (GROUND)	
6	(3)	4 AWG	THWN-2 COPPER - (L1, L2, NEUTRAL)	1" EMT
	(1)	8 AWG	THWN-2 COPPER - (GROUND)	



CONTRACTOR INFORMATION:
ENCOR SOLAR, LLC
 3049 Executive Parkway
 Suite 300
 Lehi, UT 84043
 License # U.35743

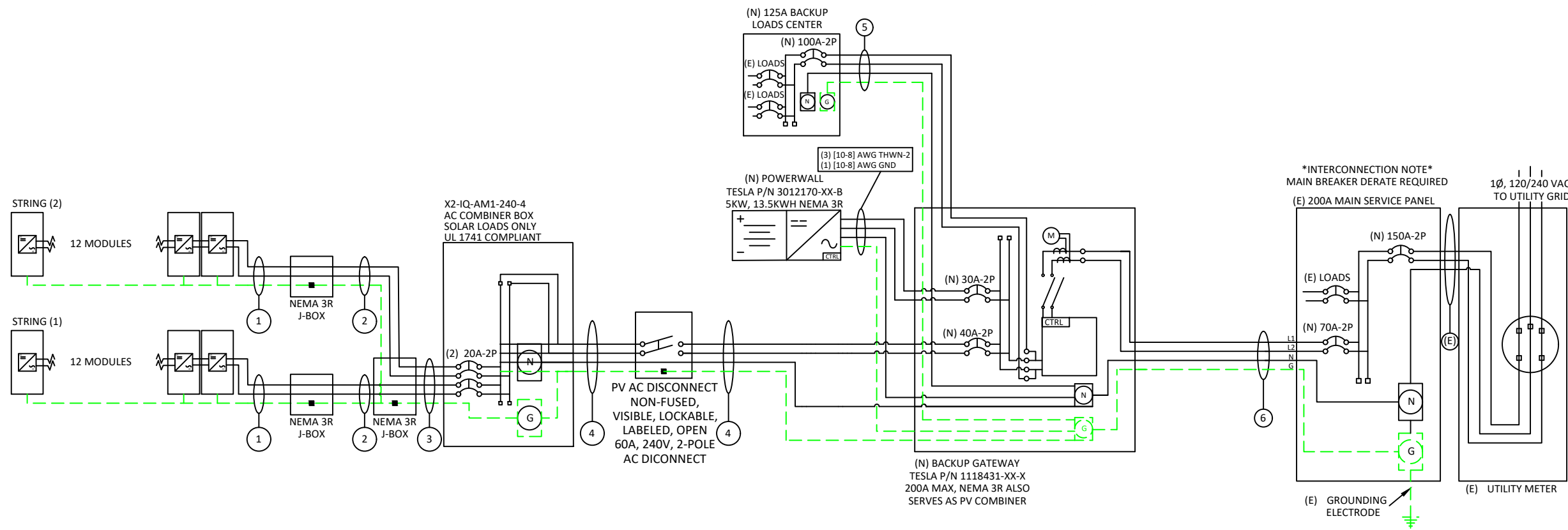

VISIBLE, LOCKABLE,
 LABELED AC DISCONNECT
 LOCATED WITHIN 10'
 OF UTILITY METER

SITE INFORMATION
ERIC ROSS
 265 OLD MONTAGUE WAY
 CAMERON, NC 28326
 AC SYSTEM SIZE: 6.96 KW AC
 DC SYSTEM SIZE: 9.6 KW DC
 LAT, 35.2674021
 LONG, -79.0209114
 (24) HANWHA Q.PEAK DUO BLK ML-G10+ 400
 PV MODULES
 (24) ENPHASE IQ8PLUS-72-2-US INVERTER(S)

CENTRAL ELECTRIC MEMBERSHIP CORP

DRAWN BY: SoloCAD
 10/4/2023
 LINE DIAGRAM - PV05

STRING CALCULATIONS		
	STRING #1	STRING #2
MAX AC CURRENT:	14.52A	14.52A
MICRO INVERTERS IN CIRCUIT	12	12
NOMINAL STRING VOLTAGE:	240V	240V
MAX AC OUTPUT POWER	3480W	3480W
ARRAY DC POWER:	9600W	
TOTAL MAX AC CURRENT:	29.04A	

SYSTEM OCPD CALCULATIONS	
INVERTER MODEL(S):	ENPHASE IQ8PLUS-72-2-US
# OF INVERTERS:	24
MAX OUTPUT CURRENT:	1.21A
(# OF INVERTERS) X (MAX OUTPUT CURRENT) X 125% + (BATTERY ADDITION) <= OCPD RATING	
(24 X 1.21A X 1.25) = 36A + 30A <= 70A, OK	

NUMBER OF CURRENT CARRYING CONDUCTORS	PERCENT OF VALUES
4-6	.80
7-9	.70
10-20	.50

BUSBAR CALCULATIONS - 120% RULE	
MAIN BUSBAR RATING:	200A
MAIN DISCONNECT RATING:	150A
PV OCPD RATING:	70A
(MAIN BUS RATING X 120%) - MAIN DISCONNECT RATING >= OCPD RATING	
(200A X 1.2) - 150A = 90A, >= 70A, OK	

CONDUIT & CONDUCTOR SCHEDULE

TAG	QTY	WIRE GAUGE	DESCRIPTION	CONDUIT SIZE	CONDUCTOR RATING	CONDUCTOR TEMP. RATE	AMBIENT TEMP	TEMP. DERATE	# OF CONDUCTORS DERATE	CONDUCTOR RATING W/DERATES	CONDUIT FILL
1	(2)	12-2	ENPHASE Q-CABLE COPPER - (L1, L2)	N/A - FREE AIR	30A	90°C	36°C	0.91	N/A - FREE AIR	27.3A	N/A - FREE AIR
	(1)	6 AWG	BARE COPPER - (GROUND)								
2	(2)	10 AWG	THHN/THWN-2 COPPER - (L1, L2)	3/4" EMT	40A	90°C	36°C	0.91	1	36.4A	11.9%
	(1)	10 AWG	THWN-2 COPPER - (GROUND)								
3	(4)	10 AWG	THHN/THWN-2 COPPER - (L1, L2)	3/4" EMT	40A	90°C	36°C	0.91	0.8	29.12A	19.8%
	(1)	10 AWG	THWN-2 COPPER -(GROUND)								
4	(3)	8 AWG	THWN-2 COPPER - (L1, L2, NEUTRAL)	3/4" EMT	50A	75°C	36°C	0.88	1	44A	24.6%
	(1)	10 AWG	THWN-2 COPPER - (GROUND)								
5	(3)	2 AWG	THWN-2 COPPER - (L1, L2, NEUTRAL)	1.25" EMT	115A	75°C	36°C	0.88	1	101.2A	25.6%
	(1)	8 AWG	THWN-2 COPPER -(GROUND)								
6	(3)	4 AWG	THWN-2 COPPER - (L1, L2, NEUTRAL)	1" EMT	85A	75°C	36°C	0.88	1	74.8A	32.9%
	(1)	8 AWG	THWN-2 COPPER -(GROUND)								



CONTRACTOR INFORMATION:
ENCOR SOLAR, LLC
 3049 Executive Parkway
 Suite 300
 Lehi, UT 84043
 License # U.35743

GROUNDING & GENERAL NOTES:

- PV INVERTER IS UNGROUNDED, TRANSFORMER-LESS TYPE.
- DC GEC AND AC EGC TO BE SPLICED TO EXISTING ELECTRODE
- ANY EXISTING WIRING INVOLVED WITH PV SYSTEM CONNECTION THAT IS FOUND TO BE INADEQUATE PER CODE SHALL BE CORRECTED PRIOR TO FINAL INSPECTION.
- JUNCTION BOX QUANTITIES, AND PLACEMENT SUBJECT TO CHANGE IN THE FIELD - JUNCTION BOXES DEPICTED ON ELECTRICAL DIAGRAM REPRESENT WIRE TYPE TRANSITIONS.
- AC DISCONNECT NOTED IN EQUIPMENT SCHEDULE OPTIONAL IF OTHER AC DISCONNECTING MEANS IS LOCATED WITHIN 10' OF SERVICE DISCONNECT.

INTERCONNECTION NOTES:

- INTERCONNECTION SIZING, LIMITATIONS AND COMPLIANCE DETERMINED IN ACCORDANCE WITH [NEC 705.12].
- GROUND FAULT PROTECTION IN ACCORDANCE WITH [NEC 215.9], [NEC 230.95] AND [NEC 690.41]
- ALL EQUIPMENT TO BE RATED FOR BACKFEEDING.
- PV BREAKER TO BE POSITIONED AT THE OPPOSITE END OF THE BUSBAR RELATIVE TO THE MAIN BREAKER.

DISCONNECT NOTES:

- DISCONNECTING SWITCHES SHALL BE WIRED SUCH THAT WHEN THE SWITCH IS OPENED THE CONDUCTORS REMAINING LIVE ARE CONNECTED TO THE TERMINALS MARKED "LINE SIDE" (TYPICALLY THE UPPER TERMINALS)
- AC DISCONNECT MUST BE ACCESSIBLE TO QUALIFIED UTILITY PERSONNEL, BE LOCKABLE, AND BE A VISIBLE-BREAK SWITCH

SITE INFORMATION

ERIC ROSS

265 OLD MONTAGUE WAY
 CAMERON, NC 28326

AC SYSTEM SIZE: 6.96 KW AC

DC SYSTEM SIZE: 9.6 KW DC

LAT, 35.2674021

LONG, -79.0209114

(24) HANWHA Q.PEAK DUO BLK ML-G10+ 400 PV MODULES

(24) ENPHASE IQ8PLUS-72-2-US INVERTER(S)

CENTRAL ELECTRIC MEMBERSHIP CORP

DRAWN BY: SoloCAD

10/4/2023

ELECTRICAL CALCS - PV06

MAIN PHOTOVOLTAIC SYSTEM DISCONNECT

LABEL 1
PLACED ON THE MAIN DISCONNECTING MEANS FOR THE PV SYSTEM.
[NEC 690.13(B)]

WARNING
ELECTRIC SHOCK HAZARD
TERMINALS ON THE LINE AND
LOAD SIDES MAY BE ENERGIZED
IN THE OPEN POSITION

LABEL 2
FOR PV DISCONNECTING MEANS WHERE THE LINE AND
LOAD TERMINALS MAY BE ENERGIZED IN THE OPEN
POSITION.
[NEC 690.13(B)]

WARNING
POWER SOURCE OUTPUT CONNECTION.
DO NOT RELOCATE THIS OVERCURRENT DEVICE.

LABEL 3
PLACED ADJACENT TO THE BACK-FED BREAKER FROM
THE INVERTER IF TIE IN CONSISTS OF LOAD SIDE
CONNECTION TO BUSBAR.
[NEC 705.12(B)(3)(2)]

CAUTION
MULTIPLE SOURCES OF POWER

LABEL 4
PLACED ON EQUIPMENT CONTAINING OVERCURRENT
DEVICES IN CIRCUITS SUPPLYING POWER TO
A BUSBAR OR CONDUCTOR SUPPLIED FROM MULTIPLE
SOURCES
[NEC 705.10]

WARNING
THIS EQUIPMENT IS FED BY MULTIPLE
SOURCES. TOTAL RATING OF ALL
OVERCURRENT DEVICES, EXCLUDING
MAIN SUPPLY OVERCURRENT
DEVICE, SHALL NOT EXCEED
AMPACITY OF BUSBAR.

LABEL 5
EQUIPMENT CONTAINING OVERCURRENT
DEVICES IN CIRCUITS SUPPLYING POWER TO A
BUSBAR OR CONDUCTOR SUPPLIED FROM
MULTIPLE SOURCES SHALL BE MARKED TO
INDICATE THE PRESENCE OF ALL SOURCES.[NEC
705.12(B)(3)(3)]

PHOTOVOLTAIC AC DISCONNECT

RATED AC OUTPUT CURRENT: 29
NOMINAL OPERATING AC VOLTAGE: 240

LABEL 6
MARKED AT AC DISCONNECTING MEANS.
[NEC 690.54]

PHOTOVOLTAIC POWER SOURCE

SOLAR PV SYSTEM EQUIPPED WITH RAPID SHUTDOWN

TURN RAPID SHUTDOWN
SWITCH TO THE "OFF"
POSITION TO SHUT DOWN
PV SYSTEM AND REDUCE
SHOCK HAZARD IN ARRAY

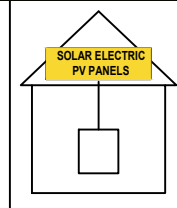

LABEL 7
AT DIRECT-CURRENT EXPOSED RACEWAYS, CABLE TRAYS, COVERS AND
ENCLOSURES OF JUNCTION BOXES, AND OTHER WIRING METHODS; SPACED
AT MAXIMUM 10FT SECTION OR WHERE SEPARATED BY ENCLOSURES, WALLS,
PARTITIONS, CEILINGS, OR FLOORS.
[NEC 690.31(D)(2)]

LABEL 8
FOR PV SYSTEMS THAT SHUT DOWN THE ARRAY AND CONDUCTORS
LEAVING THE ARRAY:
SIGN TO BE LOCATED ON OR NO MORE THAN 3 FT AWAY FROM
SERVICE DISCONNECTING MEANS TO WHICH THE PV SYSTEMS ARE
CONNECTED AND SHALL INDICATE THE LOCATION OF ALL IDENTIFIED
RAPID SHUTDOWN SWITCHES IF NOT AT THE SAME LOCATION.
[NEC 690.56(C)(1)]

RAPID SHUTDOWN SWITCH FOR SOLAR PV SYSTEM

LABEL 9
SIGN LOCATED ON OR NO MORE THAN 3FT
FROM INITIATION DEVICE
[NEC 690.56(C)(2)].

DO NOT UPSIZE MAIN BREAKER

BREAKER HAS BEEN DOWNSIZED FOR
PV SOLAR SYSTEM CONNECTION

LABEL 10
SIGN LOCATED AT POINT OF
INTERCONNECTION IF IT CONSISTS OF A
MAIN BREAKER DERATE



CONTRACTOR INFORMATION:
ENCOR SOLAR, LLC
3049 Executive Parkway
Suite 300
Lehi, UT 84043
License # U.35743

SITE INFORMATION

ERIC ROSS
265 OLD MONTAGUE WAY
CAMERON, NC 28326
AC SYSTEM SIZE: 6.96 KW AC
DC SYSTEM SIZE: 9.6 KW DC
LAT, 35.2674021
LONG, -79.0209114
(24) HANWHA Q.PEAK DUO BLK ML-G10+ 400
PV MODULES
(24) ENPHASE IQ8PLUS-72-2-US INVERTER(S)

CENTRAL ELECTRIC MEMBERSHIP CORP

DRAWN BY: SoloCAD

10/4/2023

LABELS - PV07

LABELING NOTES:

1. LABELS CALLED OUT ACCORDING TO ALL COMMON CONFIGURATIONS. ELECTRICIAN TO DETERMINE EXACT REQUIREMENTS IN THE FIELD PER CURRENT NEC AND LOCAL CODES AND MAKE APPROPRIATE ADJUSTMENTS.
2. LABELING REQUIREMENTS BASED ON THE 2020 NATIONAL ELECTRIC CODE, OSHA STANDARD 19010.145, ANSI Z535.
3. MATERIAL BASED ON THE REQUIREMENTS OF THE AUTHORITY HAVING JURISDICTION.
4. LABELS TO BE OF SUFFICIENT DURABILITY TO WITHSTAND THE ENVIRONMENT INVOLVED [NEC 110.21]
5. LABELS TO BE A MINIMUM LETTER HEIGHT OF 3/8", WHITE ON RED BACKGROUND; REFLECTIVE, AND PERMANENTLY AFFIXED [NEC 690.31(D)(2)]

LABELING DIAGRAM:

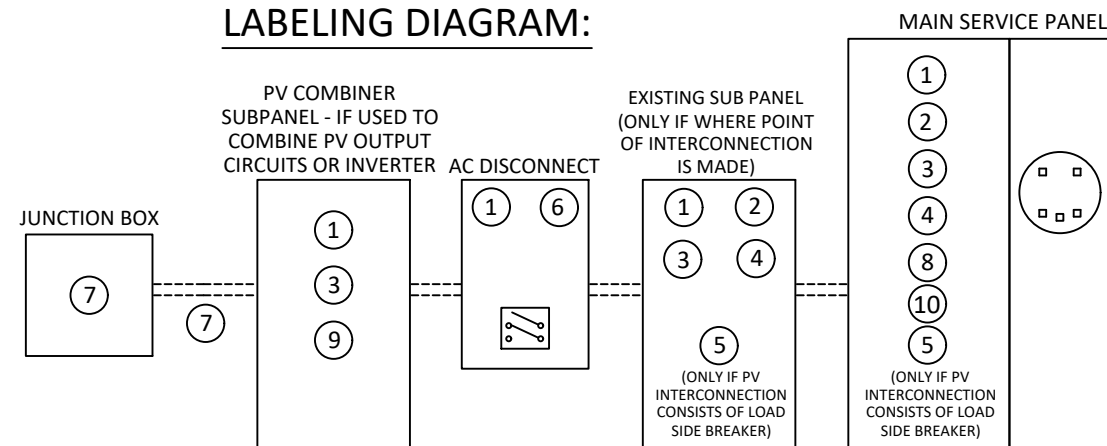

** ELECTRICAL DIAGRAM SHOWN ABOVE IS FOR LABELING PURPOSES ONLY. NOT AN ACTUAL REPRESENTATION OF EQUIPMENT AND CONNECTIONS TO BE INSTALLED. LABEL LOCATIONS PRESENTED MAY VARY DEPENDING ON TYPE OF INTERCONNECTION METHOD AND LOCATION PRESENTED ELECTRICAL DIAGRAM PAGE. **

CAUTION

POWER TO THIS BUILDING IS ALSO SUPPLIED FROM ROOF MOUNTED SOLAR ARRAYS WITH SAFETY DISCONNECTS AS SHOWN:

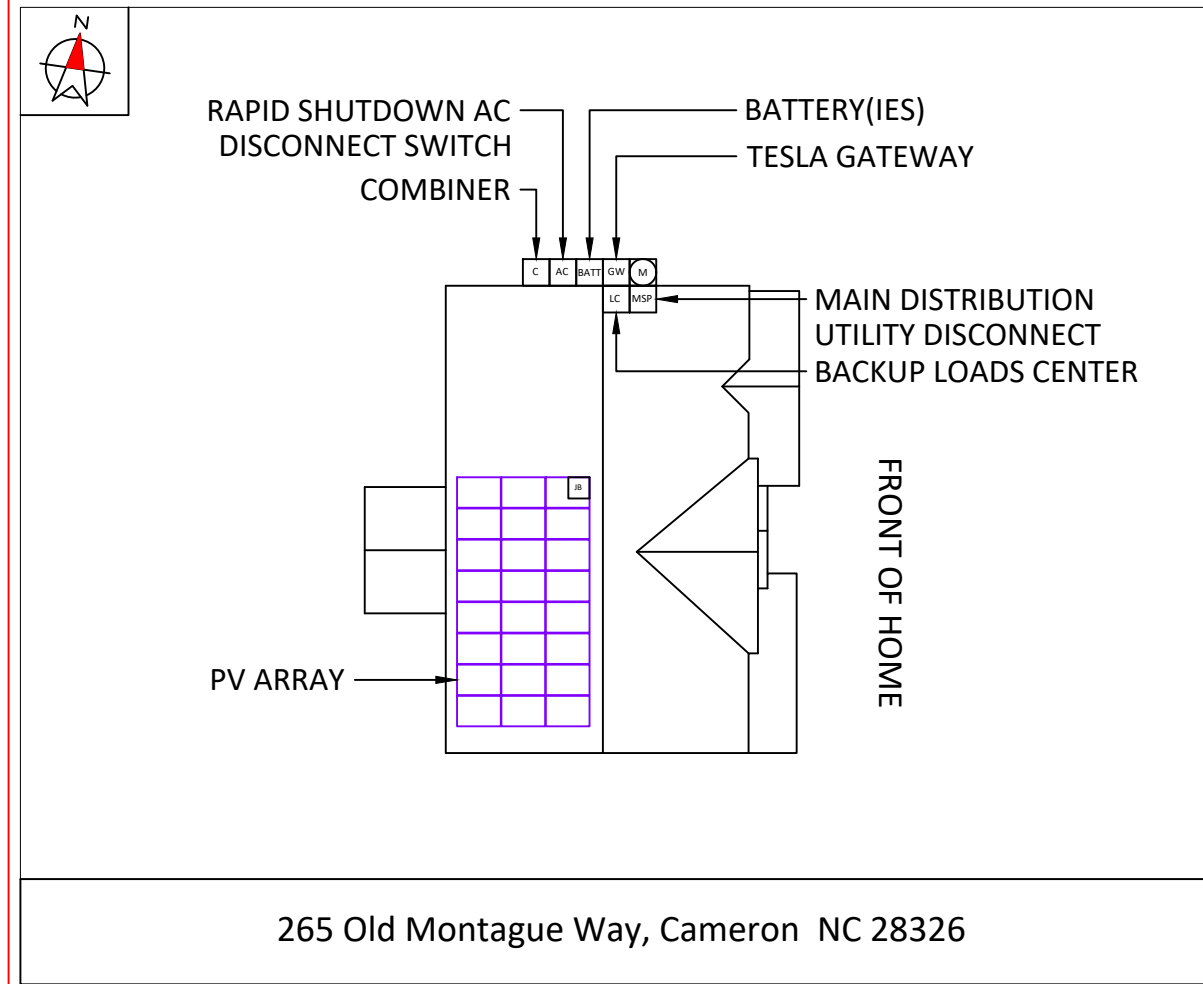

DIRECTORY:

PERMANENT PLAQUE OR DIRECTORY PROVIDING THE LOCATION OF THE SERVICE DISCONNECTING MEANS AND THE PHOTOVOLTAIC SYSTEM.
(ALL PLAQUES AND SIGNAGE WILL BE INSTALLED AS OUTLINED WITHIN: NEC 690.56(B)&(C), [NEC 705.10]



CONTRACTOR INFORMATION:

ENCOR SOLAR, LLC
3049 Executive Parkway
Suite 300
Lehi, UT 84043
License # U.35743

SITE INFORMATION

ERIC ROSS

265 OLD MONTAGUE WAY
CAMERON, NC 28326

AC SYSTEM SIZE: 6.96 KW AC

DC SYSTEM SIZE: 9.6 KW DC

LAT, 35.2674021

LONG, -79.0209114

(24) HANWHA Q.PEAK DUO BLK ML-G10+ 400
PV MODULES

(24) ENPHASE IQ8PLUS-72-2-US INVERTER(S)

CENTRAL ELECTRIC MEMBERSHIP CORP

DRAWN BY: SoloCAD

10/4/2023

PLACARD - PV08

SITE PHOTOS:

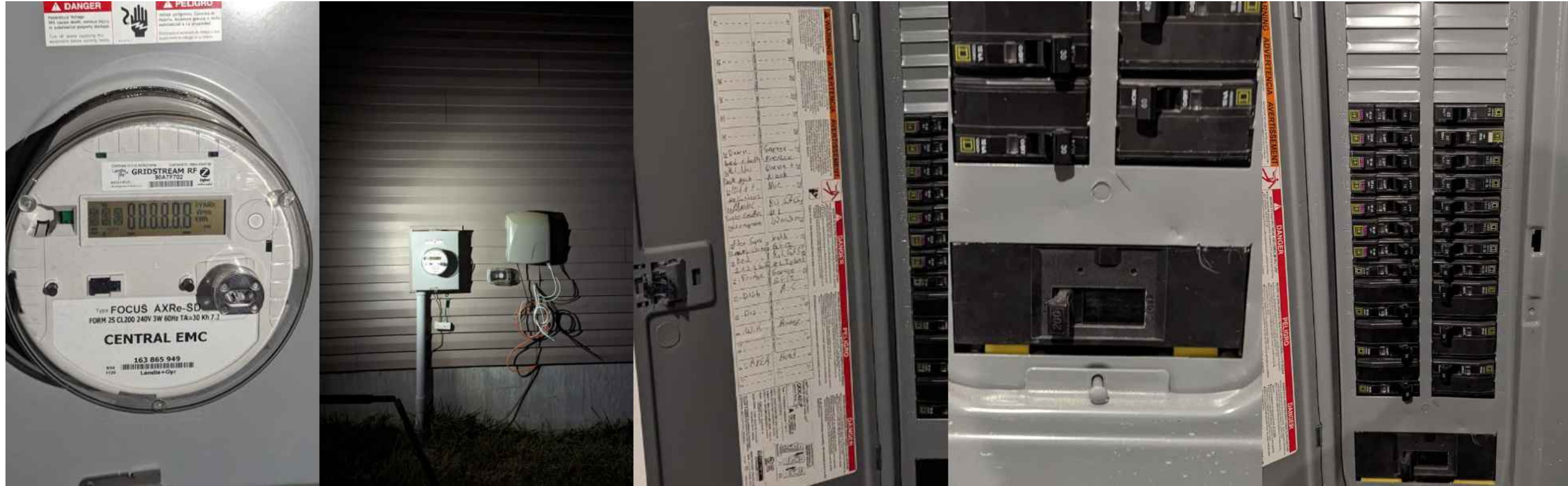

CONTRACTOR INFORMATION:
ENCOR SOLAR, LLC
3049 Executive Parkway
Suite 300
Lehi, UT 84043
License # U.35743



SITE INFORMATION

ERIC ROSS

265 OLD MONTAGUE WAY
CAMERON, NC 28326

AC SYSTEM SIZE: 6.96 KW AC

DC SYSTEM SIZE: 9.6 KW DC

LAT, 35.2674021

LONG, -79.0209114

(24) HANWHA Q.PEAK DUO BLK ML-G10+ 400
PV MODULES

(24) ENPHASE IQ8PLUS-72-2-US INVERTER(S)

CENTRAL ELECTRIC MEMBERSHIP CORP

DRAWN BY: SoloCAD

10/4/2023

SITE PHOTOS - PV09

powered by
Q.ANTUM DUO Z

Q.PEAK DUO BLK ML-G10+ 385-410

ENDURING HIGH
PERFORMANCE



BREAKING THE 20% EFFICIENCY BARRIER

Q.ANTUM DUO Z Technology with zero gap cell layout boosts module efficiency up to 21.1%.



THE MOST THOROUGH TESTING PROGRAMME IN THE INDUSTRY

Q CELLS is the first solar module manufacturer to pass the most comprehensive quality programme in the industry. The new "Quality Controlled PV" of the independent certification institute TÜV Rheinland.



INNOVATIVE ALL-WEATHER TECHNOLOGY

Optimal yields, whatever the weather with excellent low-light and temperature behaviour.



ENDURING HIGH PERFORMANCE

Long-term yield security with Anti LID Technology, Hot-Spot Protect and Traceable Quality Tra.Q™.



EXTREME WEATHER RATING

High-tech aluminium alloy frame, certified for high snow (5400Pa) and wind loads (4000Pa).



A RELIABLE INVESTMENT

Inclusive 25-year product warranty and 25-year linear performance warranty¹.

¹ See data sheet on rear for further information.

THE IDEAL SOLUTION FOR:

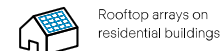

Engineered in Germany

Q CELLS

MECHANICAL SPECIFICATION

Format	1879 mm × 1045 mm × 32 mm (including frame)
Weight	22.0 kg
Front Cover	3.2 mm thermally pre-stressed glass with anti-reflection technology
Back Cover	Composite film
Frame	Black anodised aluminium
Cell	6 × 22 monocrystalline Q.ANTUM solar half cells
Junction box	53-101 mm × 32-60 mm × 15-18 mm Protection class IP67, with bypass diodes
Cable	4 mm ² Solar cable; (+) ≥ 1250 mm, (-) ≥ 1250 mm
Connector	Stäubli MC4; IP68

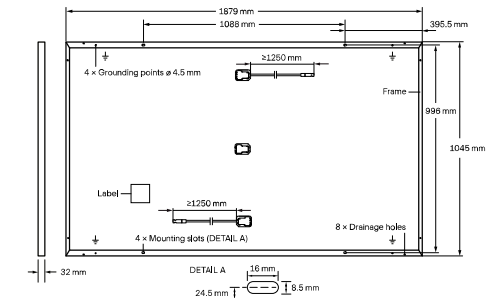

ELECTRICAL CHARACTERISTICS

POWER CLASS		385	390	395	400	405	410	
MINIMUM PERFORMANCE AT STANDARD TEST CONDITIONS, STC ¹ (POWER TOLERANCE +5 W / -0 W)								
Minimum	Power at MPP ¹	P _{MPP} [W]	385	390	395	400	405	410
	Short Circuit Current ¹	I _{SC} [A]	11.04	11.07	11.10	11.14	11.17	11.20
	Open Circuit Voltage ¹	V _{OC} [V]	45.19	45.23	45.27	45.30	45.34	45.37
	Current at MPP	I _{MPP} [A]	10.59	10.65	10.71	10.77	10.83	10.89
	Voltage at MPP	V _{MPP} [V]	36.36	36.62	36.88	37.13	37.39	37.64
	Efficiency ²	η [%]	≥ 19.6	≥ 19.9	≥ 20.1	≥ 20.4	≥ 20.6	20.9
MINIMUM PERFORMANCE AT NORMAL OPERATING CONDITIONS, NMOT ²								
Minimum	Power at MPP	P _{MPP} [W]	288.8	292.6	296.3	300.1	303.8	307.6
	Short Circuit Current	I _{SC} [A]	8.90	8.92	8.95	8.97	9.00	9.03
	Open Circuit Voltage	V _{OC} [V]	42.62	42.65	42.69	42.72	42.76	42.79
	Current at MPP	I _{MPP} [A]	8.35	8.41	8.46	8.51	8.57	8.62
	Voltage at MPP	V _{MPP} [V]	34.59	34.81	35.03	35.25	35.46	35.68

¹ Measurement tolerances P_{MPP} ± 3%; I_{SC}; V_{OC} ± 5% at STC: 1000 W/m², 25 ± 2 °C, AM 1.5 according to IEC 60904-3 • 1800 W/m², NMOT, spectrum AM 1.5

Q CELLS PERFORMANCE WARRANTY

PERFORMANCE AT LOW IRRADIANCE

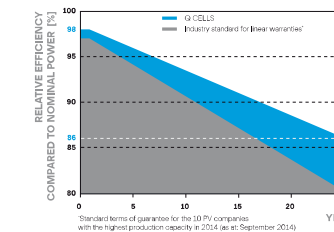

At least 98% of nominal power during first year. Thereafter max. 0.5% degradation per year. At least 93.5% of nominal power up to 10 years. At least 86% of nominal power up to 25 years.

All data within measurement tolerances. Full warranties in accordance with the warranty terms of the Q CELLS sales organisation of your respective country.

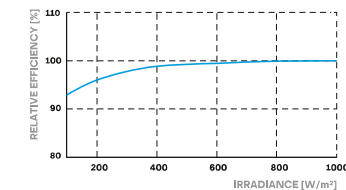

Typical module performance under low irradiance conditions in comparison to STC conditions (25 °C, 1000 W/m²).

TEMPERATURE COEFFICIENTS

Temperature Coefficient of I _{SC}	α [%/K]	+0.04	Temperature Coefficient of V _{OC}	β [%/K]	-0.27
Temperature Coefficient of P _{MPP}	γ [%/K]	-0.34	Nominal Module Operating Temperature	NMOT [°C]	43 ± 3

PROPERTIES FOR SYSTEM DESIGN

Maximum System Voltage	V _{sys} [V]	1000	PV module classification	Class II
Maximum Reverse Current	I _r [A]	20	Fire Rating based on ANSI / UL 61730	C / TYPE 2
Max. Design Load, Push / Pull	[Pa]	3600 / 2660	Permitted Module Temperature on Continuous Duty	-40 °C - +85 °C
Max. Test Load, Push / Pull	[Pa]	5400 / 4000		

QUALIFICATIONS AND CERTIFICATES

Quality Controlled PV - TÜV Rheinland; IEC 61215:2016; IEC 61730:2016. This data sheet complies with DIN EN 50380. Q-CPV Certification ongoing. Certification holder: Hanwha Q CELLS GmbH



PACKAGING INFORMATION

Horizontal packaging	1940mm	1100mm	1220mm	751kg	28 pallets	24 pallets	32 modules
----------------------	--------	--------	--------	-------	------------	------------	------------

Note: Installation instructions must be followed. See the installation and operating manual or contact our technical service department for further information on approved installation and use of this product.

Made in Korea

Hanwha Q CELLS Australia Pty Ltd

Suite 1, Level 1, 15 Blue Street, North Sydney, NSW 2060, Australia | TEL +61 (0)2 9016 3033 | FAX +61 (0)2 9016 3032 | EMAIL q-cells-australia@q-cells.com | WEB www.q-cells.com/au

Engineered in Germany

Q CELLS



IQ8 Series Microinverters

Our newest IQ8 Microinverters are the industry's first microgrid-forming, software-defined microinverters with split-phase power conversion capability to convert DC power to AC power efficiently. The brain of the semiconductor-based microinverter is our proprietary application-specific integrated circuit (ASIC) which enables the microinverter to operate in grid-tied or off-grid modes. This chip is built in advanced 55nm technology with high speed digital logic and has super-fast response times to changing loads and grid events, alleviating constraints on battery sizing for home energy systems.



Part of the Enphase Energy System, IQ8 Series Microinverters integrate with the Enphase IQ Battery, Enphase IQ Gateway, and the Enphase App monitoring and analysis software.



IQ8 Series Microinverters redefine reliability standards with more than one million cumulative hours of power-on testing, enabling an industry-leading limited warranty of up to 25 years.



Connect PV modules quickly and easily to IQ8 Series Microinverters using the included Q-DCC-2 adapter cable with plug-n-play MC4 connectors.



IQ8 Series Microinverters are UL Listed as PV Rapid Shut Down Equipment and conform with various regulations, when installed according to manufacturer's instructions.

Easy to install

- Lightweight and compact with plug-n-play connectors
- Power Line Communication (PLC) between components
- Faster installation with simple two-wire cabling

High productivity and reliability

- Produce power even when the grid is down
- More than one million cumulative hours of testing
- Class II double-insulated enclosure
- Optimized for the latest high-powered PV modules

Microgrid-forming

- Complies with the latest advanced grid support
- Remote automatic updates for the latest grid requirements
- Configurable to support a wide range of grid profiles
- Meets CA Rule 21 (UL 1741-SA) requirements

IQ8 Series Microinverters

INPUT DATA (DC)		IQ8-60-2-US	IQ8PLUS-72-2-US	IQ8M-72-2-US	IQ8A-72-2-US	IQ8H-240-72-2-US	IQ8H-208-72-2-US ¹
Commonly used module pairings ²	W	235 – 350	235 – 440	260 – 460	295 – 500	320 – 540+	295 – 500+
Module compatibility		60-cell/120 half-cell		60-cell/120 half-cell and 72-cell/144 half-cell			
MPPT voltage range	V	27 – 37	29 – 45	33 – 45	36 – 45	38 – 45	38 – 45
Operating range	V	25 – 48		25 – 58			
Min/max start voltage	V	30 / 48		30 / 58			
Max input DC voltage	V	50		60			
Max DC current ³ [module Isc]	A			15			
Overvoltage class DC port				II			
DC port backfeed current	mA			0			
PV array configuration		1x1 Ungrounded array; No additional DC side protection required; AC side protection requires max 20A per branch circuit					
OUTPUT DATA (AC)		IQ8-60-2-US	IQ8PLUS-72-2-US	IQ8M-72-2-US	IQ8A-72-2-US	IQ8H-240-72-2-US	IQ8H-208-72-2-US
Peak output power	VA	245	300	330	366	384	366
Max continuous output power	VA	240	290	325	349	380	360
Nominal (L-L) voltage/range ⁴	V			240 / 211 – 264		208 / 183 – 250	
Max continuous output current	A	1.0	1.21	1.35	1.45	1.58	1.73
Nominal frequency	Hz	60					
Extended frequency range	Hz	50 – 68					
Max units per 20 A (L-L) branch circuit ⁵		16	13	11	11	10	9
Total harmonic distortion		<5%					
Overvoltage class AC port		III					
AC port backfeed current	mA	30					
Power factor setting		1.0					
Grid-tied power factor (adjustable)		0.85 leading – 0.85 lagging					
Peak efficiency	%	97.5	97.6	97.6	97.6	97.6	97.4
CEC weighted efficiency	%	97	97	97	97.5	97	97
Night-time power consumption	mW	60					
MECHANICAL DATA							
Ambient temperature range		-40°C to +60°C (-40°F to +140°F)					
Relative humidity range		4% to 100% (condensing)					
DC Connector type		MC4					
Dimensions (HxWxD)		212 mm (8.3") x 175 mm (6.9") x 30.2 mm (1.2")					
Weight		1.08 kg (2.38 lbs)					
Cooling		Natural convection – no fans					
Approved for wet locations		Yes					
Acoustic noise at 1 m		<60 dBA					
Pollution degree		PD3					
Enclosure		Class II double-insulated, corrosion resistant polymeric enclosure					
Environ. category / UV exposure rating		NEMA Type 6 / outdoor					
COMPLIANCE							
Certifications		CA Rule 21 (UL 1741-SA), UL 62109-1, UL1741/IEEE1547, FCC Part 15 Class B, ICES-0003 Class B, CAN/CSA-C22.2 NO. 107.1-01					
		This product is UL Listed as PV Rapid Shut Down Equipment and conforms with NEC 2014, NEC 2017, and NEC 2020 section 690.12 and C22.1-2018 Rule 64-218 Rapid Shutdown of PV Systems, for AC and DC conductors, when installed according to manufacturer's instructions.					

(1) The IQ8H-208 variant will be operating in grid-tied mode only at 208V AC. (2) No enforced DC/AC ratio. See the compatibility calculator at <https://link.enphase.com/module-compatibility> (3) Maximum continuous input DC current is 10.6A (4) Nominal voltage range can be extended beyond nominal if required by the utility. (5) Limits may vary. Refer to local requirements to define the number of microinverters per branch in your area.

IQ Combiner 4/4C



The **IQ Combiner 4/4C** with IQ Gateway and integrated LTE-M1 cell modem (included only with IQ Combiner 4C) consolidates interconnection equipment into a single enclosure. It streamlines IQ Microinverters and storage installations by providing a consistent, pre-wired solution for residential applications. It offers up to four 2-pole input circuits and Eaton BR series busbar assembly.

Smart

- Includes IQ Gateway for communication and control
- Includes Mobile Connect cellular modem (CELLMODEM-M1-06-SP-05), included only with IQ Combiner 4C
- Includes solar shield to match Enphase IQ Battery aesthetics and deflect heat
- Supports Wi-Fi, Ethernet, or cellular connectivity
- Optional AC receptacle available for PLC bridge
- Provides production metering and consumption monitoring

Simple

- Mounts on single stud with centered brackets
- Supports bottom, back and side conduit entry
- Allows up to four 2-pole branch circuits for 240VAC plug-in breakers (not included)
- 80A total PV or storage branch circuits

Reliable

- Durable NRTL-certified NEMA type 3R enclosure
- Five-year limited warranty
- Two years labor reimbursement program coverage included for both the IQ Combiner SKU's
- UL listed
- X2-IQ-AM1-240-4 and X2-IQ-AM1-240-4C comply with IEEE 1547:2018 (UL 1741-SB, 3rd Ed.)

IQ Combiner 4/4C

MODEL NUMBER	
IQ Combiner 4 X-IQ-AM1-240-4 X2-IQ-AM1-240-4 (IEEE 1547:2018)	IQ Combiner 4 with IQ Gateway printed circuit board for integrated revenue grade PV production metering (ANSI C12.20 ± 0.5%) and consumption monitoring (± 2.5%). Includes a silver solar shield to match the IQ Battery and IQ System Controller 2 and to deflect heat.
IQ Combiner 4C X-IQ-AM1-240-4C X2-IQ-AM1-240-4C (IEEE 1547:2018)	IQ Combiner 4C with IQ Gateway printed circuit board for integrated revenue grade PV production metering (ANSI C12.20 ± 0.5%) and consumption monitoring (± 2.5%). Includes Mobile Connect cellular modem (CELLMODEM-M1-06-SP-05), a plug-and-play industrial-grade cell modem for systems up to 60 microinverters. (Available in the US, Canada, Mexico, Puerto Rico, and the US Virgin Islands, where there is adequate cellular service in the installation area.) Includes a silver solar shield to match the IQ Battery and IQ System Controller and to deflect heat.
ACCESSORIES AND REPLACEMENT PARTS (not included, order separately)	
Supported microinverters	IQ6, IQ7, and IQ8. (Do not mix IQ6/7 Microinverters with IQ8)
Communications Kit COMMS-CELLMODEM-M1-06 CELLMODEM-M1-06-SP-05 CELLMODEM-M1-06-AT-05	- Includes COMMS-KIT-01 and CELLMODEM-M1-06-SP-05 with 5-year Sprint data plan - 4G based LTE-M1 cellular modem with 5-year Sprint data plan - 4G based LTE-M1 cellular modem with 5-year AT&T data plan
Circuit Breakers BRK-10A-2-240V BRK-15A-2-240V BRK-20A-2P-240V BRK-15A-2P-240V-B BRK-20A-2P-240V-B	Supports Eaton BR210, BR215, BR220, BR230, BR240, BR250, and BR260 circuit breakers. Circuit breaker, 2 pole, 10A, Eaton BR210 Circuit breaker, 2 pole, 15A, Eaton BR215 Circuit breaker, 2 pole, 20A, Eaton BR220 Circuit breaker, 2 pole, 15A, Eaton BR215B with hold down kit support Circuit breaker, 2 pole, 20A, Eaton BR220B with hold down kit support
XA-SOLARSHIELD-ES XA-PLUG-120-3	Replacement solar shield for IQ Combiner 4/4C Accessory receptacle for Power Line Carrier in IQ Combiner 4/4C (required for EPLC-01)
X-IQ-NA-HD-125A	Hold-down kit for Eaton circuit breaker with screws
Consumption monitoring CT (CT-200-SPLIT/CT-200-CLAMP)	A pair of 200A split core current transformers
ELECTRICAL SPECIFICATIONS	
Rating	Continuous duty
System voltage	120/240VAC, 60 Hz
Eaton BR series busbar rating	125A
Max. continuous current rating	65A
Max. continuous current rating (input from PV/storage)	64A
Max. fuse/circuit rating (output)	90A
Branch circuits (solar and/or storage)	Up to four 2-pole Eaton BR series Distributed Generation (DG) breakers only (not included)
Max. total branch circuit breaker rating (input)	80A of distributed generation/95A with IQ Gateway breaker included
IQ Gateway breaker	10A or 15A rating GE/Siemens/Eaton included
Production metering CT	200A solid core pre-installed and wired to IQ Gateway
MECHANICAL DATA	
Dimensions (WxHxD)	37.5 cm x 49.5 cm x 16.8 cm (14.75 in x 19.5 in x 6.63 in). Height is 53.5 cm (21.06 in) with mounting brackets.
Weight	7.5 kg (16.5 lbs)
Ambient temperature range	-40°C to +46°C (-40°F to 115°F)
Cooling	Natural convection, plus heat shield
Enclosure environmental rating	Outdoor, NRTL-certified, NEMA type 3R, polycarbonate construction
Wire sizes	• 20A to 50A breaker inputs: 14 to 4 AWG copper conductors • 60A breaker branch input: 4 to 1/0 AWG copper conductors • Main lug combined output: 10 to 2/0 AWG copper conductors • Neutral and ground: 14 to 1/0 copper conductors • Always follow local code requirements for conductor sizing.
Altitude	Up to 3,000 meters (9,842 feet)
INTERNET CONNECTION OPTIONS	
Integrated Wi-Fi	IEEE 802.11b/g/n
Cellular	CELLMODEM-M1-06-SP-05, CELLMODEM-M1-06-AT-05 (4G based LTE-M1 cellular modem). Note that an Mobile Connect cellular modem is required for all Enphase Energy System installations.
Ethernet	Optional, IEEE 802.3, Cat5E (or Cat6) UTP Ethernet cable (not included)
COMPLIANCE	
Compliance, IQ Combiner	CA Rule 21 (UL 1741-SA) IEEE 1547:2018 - UL 1741-SB, 3 rd Ed. (X2-IQ-AM1-240-4 and X2-IQ-AM1-240-4C) CAN/CSA C22.2 No. 107.1, Title 47 CFR, Part 15, Class B, ICES 003 Production metering: ANSI C12.20 accuracy class 0.5 (PV production) Consumption metering: accuracy class 2.5
Compliance, IQ Gateway	UL 60601-1/CANCSA 22.2 No. 61010-1

© 2022 Enphase Energy. All rights reserved. Enphase, the Enphase logo, IQ Combiner 4/4C, and other names are trademarks of Enphase Energy, Inc. Data subject to change.

IQ-C-4-4C-DS-0103-EN-US-12-29-2022



To learn more about Enphase offerings, visit enphase.com
IQ-C-4-4C-DS-0103-EN-US-12-29-2022



POWERWALL

Tesla Powerwall is a fully-integrated AC battery system for residential or light commercial use. Its rechargeable lithium-ion battery pack provides energy storage for solar self-consumption, time-based control, and backup.

Powerwall's electrical interface provides a simple connection to any home or building. Its revolutionary compact design achieves market-leading energy density and is easy to install, enabling owners to quickly realize the benefits of reliable, clean power.



PERFORMANCE SPECIFICATIONS

AC Voltage (Nominal)	120/240 V
Feed-In Type	Split Phase
Grid Frequency	60 Hz
Total Energy ¹	14 kWh
Usable Energy ¹	13.5 kWh
Real Power, max continuous	5 kW (charge and discharge)
Real Power, peak (10s, off-grid/backup)	7 kW (charge and discharge)
Apparent Power, max continuous	5.8 kVA (charge and discharge)
Apparent Power, peak (10s, off-grid/backup)	7.2 kVA (charge and discharge)
Load Start Capability	88 - 106 A LRA ²
Maximum Supply Fault Current	10 kA
Maximum Output Fault Current	32 A
Overcurrent Protection Device	30 A
Imbalance for Split-Phase Loads	100%
Power Factor Output Range	+/- 1.0 adjustable
Power Factor Range (full-rated power)	+/- 0.85
Internal Battery DC Voltage	50 V
Round Trip Efficiency	90% ^{1,3}
Warranty	10 years

¹Values provided for 25°C (77°F), 3.3 kW charge/discharge power.

²Load start capability may vary.

³AC to battery to AC, at beginning of life.

COMPLIANCE INFORMATION

Certifications	UL 1642, UL 1741, UL 1973, UL 9540, IEEE 1547, UN 38.3
Grid Connection	Worldwide Compatibility
Emissions	FCC Part 15 Class B, ICES 003
Environmental	RoHS Directive 2011/65/EU
Seismic	AC156, IEEE 693-2005 (high)
Fire Testing	Meets the unit level performance criteria of UL 9540A

MECHANICAL SPECIFICATIONS

Dimensions	1150 mm x 753 mm x 147 mm (45.3 in x 29.6 in x 5.75 in) ⁴
Weight	114 kg (251.3 lbs) ⁴
Mounting options	Floor or wall mount

⁴Dimensions and weight differ slightly if manufactured before March 2019. Contact Tesla for additional information.

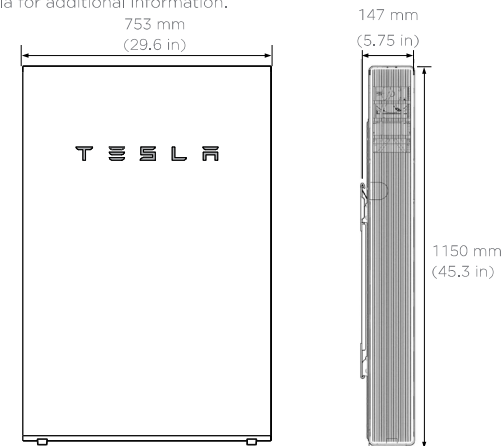

ENVIRONMENTAL SPECIFICATIONS

Operating Temperature	-20°C to 50°C (-4°F to 122°F) ⁵
Recommended Temperature	0°C to 30°C (32°F to 86°F)
Operating Humidity (RH)	Up to 100%, condensing
Storage Conditions	-20°C to 30°C (-4°F to 86°F) Up to 95% RH, non-condensing State of Energy (SoE): 25% initial
Maximum Elevation	3000 m (9843 ft)
Environment	Indoor and outdoor rated
Enclosure Type	NEMA 3R
Ingress Rating	IP67 (Battery & Power Electronics) IP56 (Wiring Compartment)
Wet Location Rating	Yes
Noise Level @ 1m	< 40 dBA at 30°C (86°F)

⁵Performance may be de-rated at operating temperatures below 10°C (50°F) or greater than 43°C (109°F).

TYPICAL SYSTEM LAYOUTS

WHOLE HOME BACKUP

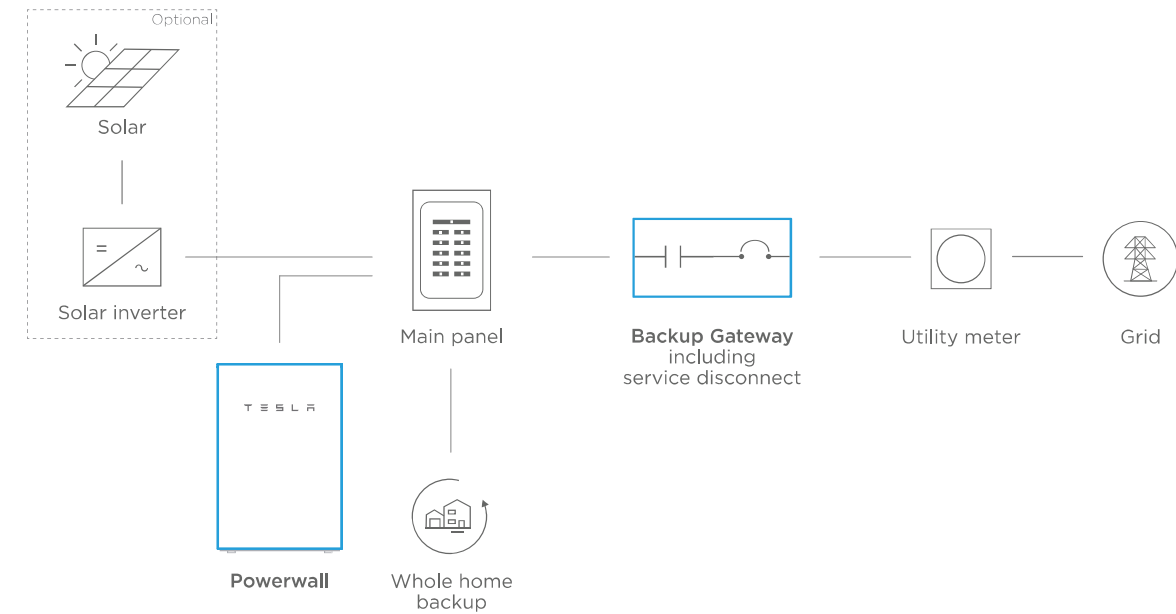

PARTIAL HOME BACKUP

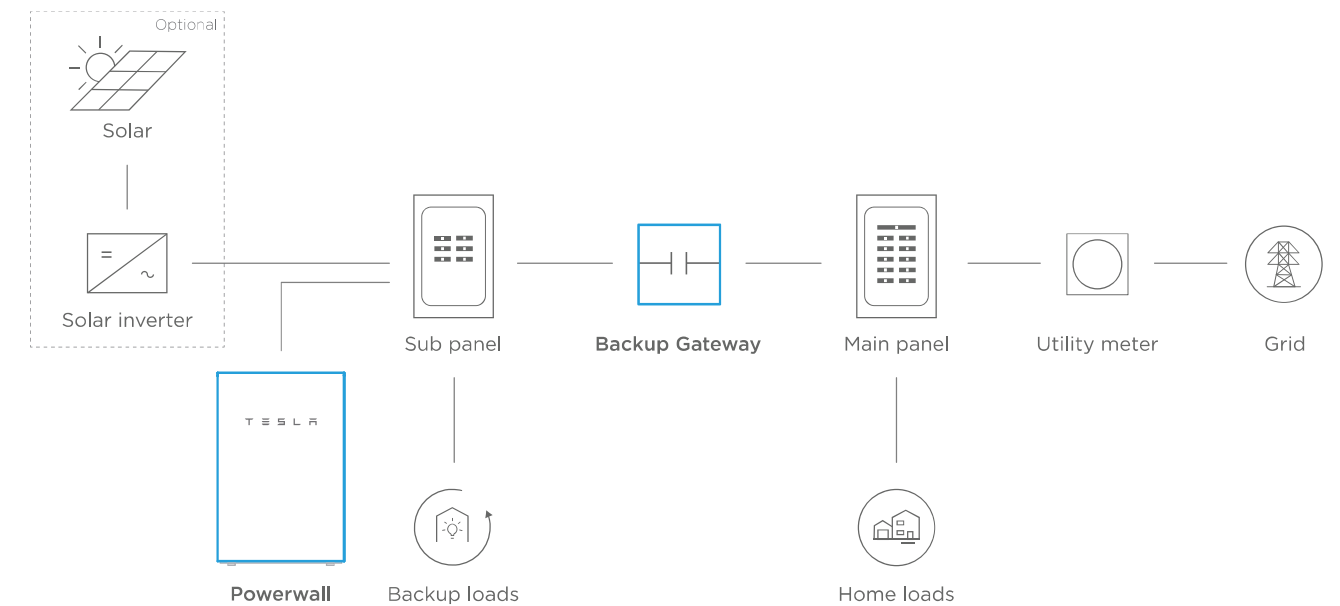

POWERWALL

Backup Gateway 2

The Backup Gateway 2 for Tesla Powerwall provides energy management and monitoring for solar self-consumption, time-based control, and backup.

The Backup Gateway 2 controls connection to the grid, automatically detecting outages and providing a seamless transition to backup power. When equipped with a main circuit breaker, the Backup Gateway 2 can be installed at the service entrance. When the optional internal panelboard is installed, the Backup Gateway 2 can also function as a load center.

The Backup Gateway 2 communicates directly with Powerwall, allowing you to monitor energy use and manage backup energy reserves from any mobile device with the Tesla app.



PERFORMANCE SPECIFICATIONS

Model Number	1232100-xx-y
AC Voltage (Nominal)	120/240V
Feed-In Type	Split Phase
Grid Frequency	60 Hz
Current Rating	200 A
Maximum Input Short Circuit Current	10 kA ¹
Overcurrent Protection Device	100-200A; Service Entrance Rated ¹
Overvoltage Category	Category IV
AC Meter	Revenue accurate (+/- 0.2 %)
Primary Connectivity	Ethernet, Wi-Fi
Secondary Connectivity	Cellular (3G, LTE/4G) ²
User Interface	Tesla App
Operating Modes	Support for solar self-consumption, time-based control, and backup
Backup Transition	Automatic disconnect for seamless backup
Modularity	Supports up to 10 AC-coupled Powerwalls
Optional Internal Panelboard	200A 6-space / 12 circuit Eaton BR Circuit Breakers
Warranty	10 years

¹ When protected by Class J fuses, Backup Gateway 2 is suitable for use in circuits capable of delivering not more than 22kA symmetrical amperes.

² The customer is expected to provide internet connectivity for Backup Gateway 2; cellular should not be used as the primary mode of connectivity. Cellular connectivity subject to network operator service coverage and signal strength.

COMPLIANCE INFORMATION

Certifications	UL 67, UL 869A, UL 916, UL 1741 PCS CSA 22.2 0.19, CSA 22.2 205
Emissions	FCC Part 15, ICES 003

MECHANICAL SPECIFICATIONS

Dimensions	660 mm x 411 mm x 149 mm (26 in x 16 in x 6 in)
Weight	20.4 kg (45 lb)
Mounting options	Wall mount, Semi-flush mount

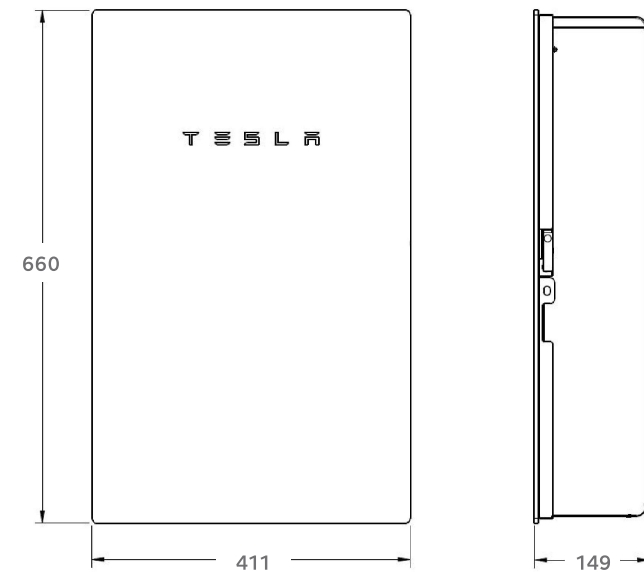

ENVIRONMENTAL SPECIFICATIONS

Operating Temperature	-20°C to 50°C (-4°F to 122°F)
Operating Humidity (RH)	Up to 100%, condensing
Maximum Elevation	3000 m (9843 ft)
Environment	Indoor and outdoor rated
Enclosure Type	NEMA 3R

CrossRail System



 DATA SHEET

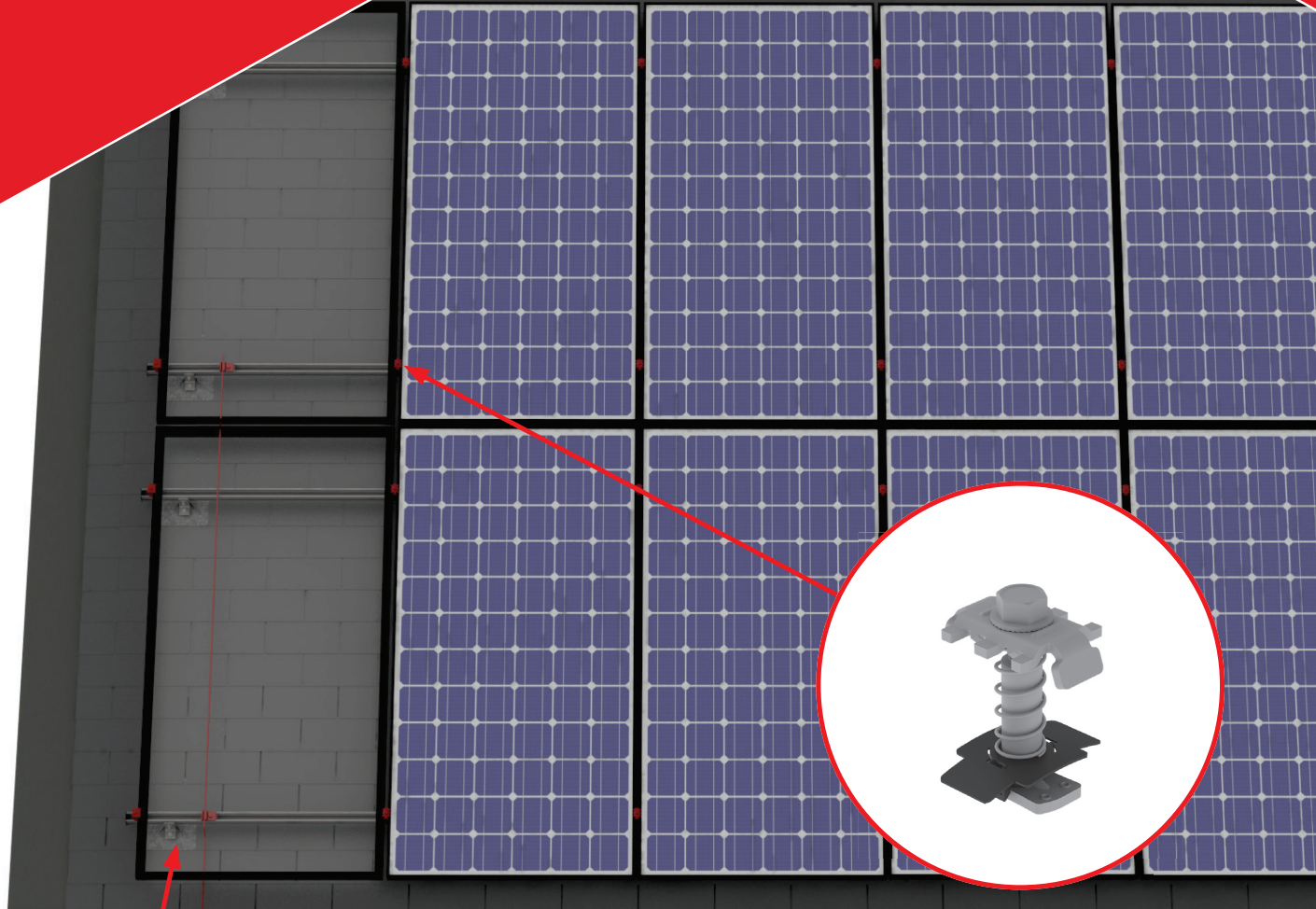

In-Rail Wire Management
 / 4 open channel rail types available
 / Wires help with clamps and wire management clips
 / 3 clip types available

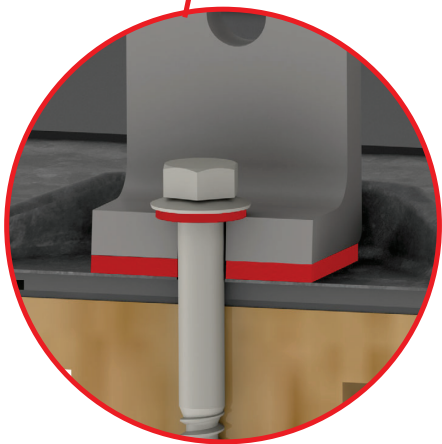

K2 Flash Comp Kit Waterproofing
 / Water Shield redirects water away from penetration
 / K2 EverSeal preassembled on L-Foot
 / EPDM backed sealing washing on lag screw

PRODUCT FEATURES



- / High quality, German-engineered system for residential and commercial installations
- / 4 rail sizes available to suit all structural conditions
- / Universal components for all rail types
- / Use 2 innovative components to turn this system into Shared Rail or Tilt Up
- / MK3 technology provides highest rail engagement
- / Roof attachments for all roof types
- / 100% code compliant, structural validation for all solar states
- / Fast installation with minimal component count result in low total installed cost

TECHNICAL DATA

	CrossRail System
Roof Type	Composition shingle, tile, standing seam, corrugated metal, trapezoidal metal
Material	High corrosion resistance stainless steel and high grade aluminum
Flexibility	Modular construction, suitable for any system size, height adjustable
PV Modules	For all common module types
Module Orientation	Portrait and landscape
Roof Connection	Rafter or deck connection depending on selected roof attachment
Structural Validity	IBC compliant, stamped engineering letters available for all solar states
Certifications	UL 2703, ASCE 7-16, Class A Fire Rating
Warranty	25 years

Components

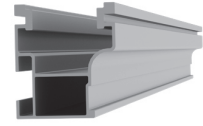

CrossRail 44-X

Part Number	Description
4000019	CrossRail 44-X, 166", Mill
4000020	CrossRail 44-X, 166", Dark
4000021	CrossRail 44-X, 180", Mill
4000022	CrossRail 44-X, 180", Dark

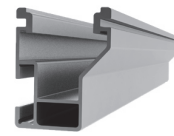

CrossRail 48-X

Part Number	Description
4000662	CrossRail 48-X, 166", Mill
4000663	CrossRail 48-X, 166", Dark

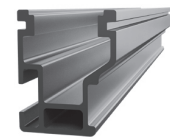

CrossRail 48-XL

Part Number	Description
4000695	CrossRail 48-XL, 166", Mill
4000705	CrossRail 48-XL, 166", Dark



Yeti Clamp

Part Number	Description
4000050-H	Yeti Hidden EC for CR, 13mm Hex Set



K2 Mid Clamp

Part Number	Description
4000601-H	CR MC Silver, 30-47mm, 13mm Hex
4000602-H	CR MC Dark, 30-47mm, 13mm Hex
4000688-H	CR MC Silver, 40-50mm, 13mm Hex
4000689-H	CR MC Dark, 40-50mm, 13mm Hex



K2 End Clamp

Part Number	Description
4000090	CR EC Silver, 30-40mm
4000091	CR EC Dark, 30-40mm
4000092	CR EC Silver, 40-47mm
4000093	CR EC Dark, 40-47mm



CrossRail 80

Part Number	Description
4000508	CrossRail 80 168" Rail Mill



L-Foot & T-Foot

Part Number	Description
4000630	L-Foot Slotted Set, Mill
4000631	L-Foot Slotted Set, Dark
4000080	T-Foot X 6" Kit, Mill
4000218	Big Foot 6" w/3" + Chem Link Clip Kit

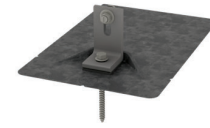

K2 Metal Flashings

Part Number	Description
4000156	K2 Flash Comp Kit, Mill
4000157	K2 Flash Comp Kit, Dark



Bonding & Grounding

Part Number	Description
4000629-H	CR Microinverter & Opt, 13mm Hex Kit
4000006-H	Everest Ground Lug, 13mm Hex
4000083	MLPE, Module Frame Mount, Kit

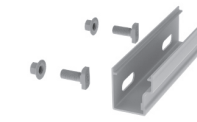

CrossRail Rail Connector

Part Number	Description
4000051	Rail Connector CR 44-X, Set, Mill
4000052	Rail Connector CR 44-X, Set, Dark
4000385	RailConn CR48-X,48-XL Struct Set, Mill
4000386	RailConn CR48-X,48-XL Struct Set, Dark
4001196	Rail Connector UL 2703 Set, CR80, Mill



End Caps

Part Number	Description
4000176	EndCap 44-X, K2
4000431	CrossRail Flat EndCap, CR 48-X, 48-XL
4001221	EndCap, Black, CR80



Splice Foot X & XL

Part Number	Description
4000131	Splice Foot X, Set, Mill
4000162	Splice Foot XL, Set, Mill
4000115	Splice Foot Screw, m5x60

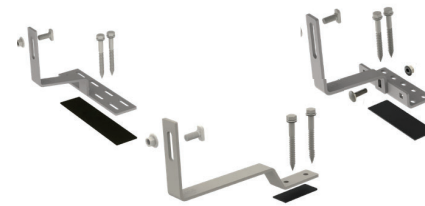

EverSeal Tile Hooks

Part Number	Description
4000140-B	USH, 9", Bake Kit, w/Butyl
4000141-B	Flat Tile Hook X Kit, w/Butyl
4000142-B	USH +2, 5.5" Base Kit, w/Butyl

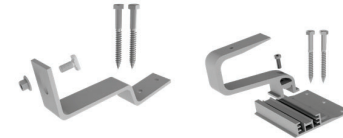

Standard Tile Hooks

Part Number	Description
4000034	Flat Tile Hook Set, w/Lags
4001294	Tile Hook 3S Wide Base w/Hardware
4000140	Universal Standard Hook 9" Base Kit
4000141	Flat Tile Hook X, Kit
4000142	Universal Standard Hook +2, 5.5" Base, Kit



Wire Management

Part Number	Description
4000069	Wire Management Clip, TC
4000382	HEYClip SunRunner Cable Slip SS, S6404
4005394	Wire Management Clip, Omega, Black



CR 48-X/48-XL Sleeve

Part Number	Description
4000177	Sleeve CR 44-X
4000583	CrosRail 3" Black Sleeve 48-X, 48-XL



Standing Seam PowerClamps

Part Number	Description
4000016	Standing Seam PowerClamp, Mini, Set
4000017	Standing Seam PowerClamp, Standard, Set



Corrugated Power Clamp, Kit

Part Number	Description
4000307	Corrugated PowerClamp, Kit



Trapezoidal Power Clamp, Kit

Part Number	Description
4000308	Trapezoidal PowerClamp, Kit



Connecting Strength

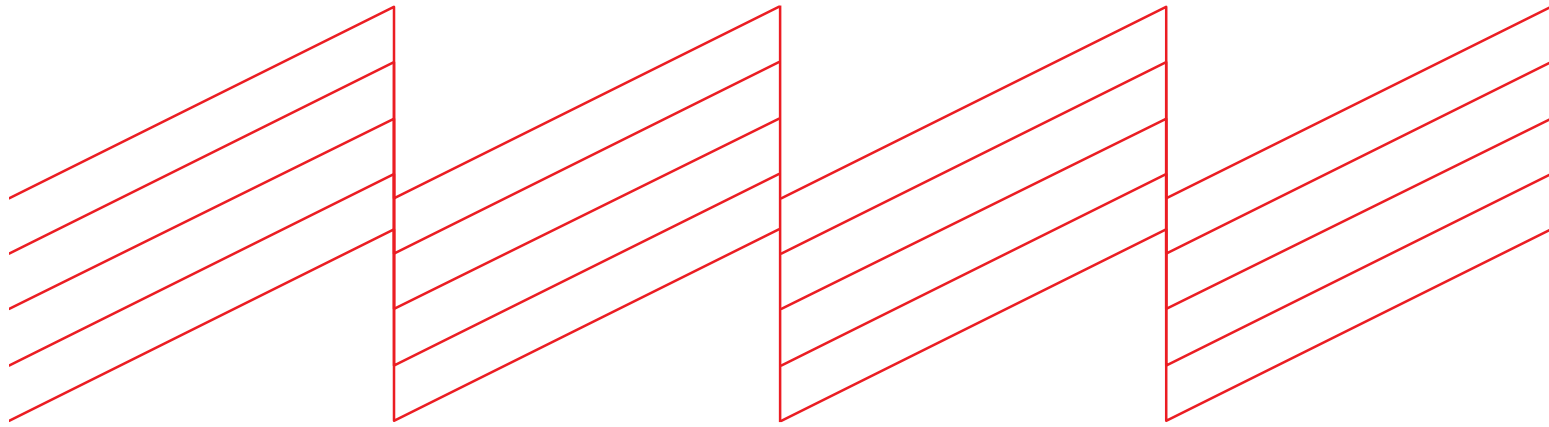

K2 Systems, LLC

4665 North Ave. Suite I • Oceanside, CA 92056 •
USA +1.760.301.5300 • infous@k2-systems.com
www.k2-systems.com

CrossRail System Data Sheet V10 | 0323 • Subject to change
Product illustrations are exemplary and may differ from the original.

FLASHKIT PRO



FLASHKIT PRO is the complete attachment solution for composition shingle roofs. Featuring Unirac's patented SHED & SEAL technology, a weather proof system which provides the ultimate protection against roof leaks. Kitted in 10 packs for maximum convenience, flashings and hardware are available in Mill or Dark finishes. With FLASHKIT pro, you have everything you need for a quick, professional installation.



TRUSTED WATER SEAL FLASHINGS
FEATURING SHED & SEAL TECHNOLOGY



YOUR COMPLETE SOLUTION
Flashings, lags, continuous slot L-Feet and hardware



CONVENIENT 10 PACKS
Packaged for speed and ease of handling

FLASHKIT PRO

INSTALLATION GUIDE



FLASHKIT PRO IS THE COMPLETE FLASHING AND ATTACHMENT SOLUTION FOR COMPOSITION ROOFS.



STEP 1
INSTALL FLASHKIT PRO FLASHING



STEP 2
INSTALL L-FOOT



STEP 3
ATTACH L-FOOT TO RAIL

PRE-INSTALL

- Locate roof rafters and snap chalk lines to mark the installation point for each roof attachment.
- Drill a 7/32" pilot hole at each roof attachment. Fill each pilot hole with sealant.

STEP 1 INSTALL FLASHKIT PRO FLASHING

- Add a U-shaped bead of roof sealant to the underside of the flashing with the open side of the U pointing down the roof slope. Slide the aluminum flashing underneath the row of shingles directly up slope from the pilot hole as shown. Align the indicator marks on the lower end of the flashing with the chalk lines on the roof to center the raised hole in the flashing over the pilot hole in the roof. When installed correctly, the flashing will extend under the two courses of shingles above the pilot hole.

STEP 2 INSTALL L-FOOT

- Fasten L-foot and Flashing into place by passing the included lag bolt and pre-installed stainless steel-backed EPDM washer through the L-foot EPDM grommet, and the raised hole in the flashing, into the pilot hole in the roof rafter.

- Drive the lag bolt down until the L-foot is held firmly in place. It is normal for the EPDM on the underside of the stainless steel backed EPDM washer to compress and expand beyond the outside edge of the steel washer when the proper torque is applied.

TIP:

- Use caution to avoid over-torquing the lag bolt if using an impact driver.
- Repeat Steps 1 and 2 at each roof attachment point.

STEP 3 ATTACH L-FOOT TO RAIL

- Insert the included 3/8" -16 T-bolts into the lower slot on the Rail (sold separately), spacing the bolts to match the spacing between the roof attachments.
- Position the Rail against the L-Foot and insert the threaded end of the T-Bolt through the continuous slot in the L-Foot. Apply anti-seize to bolt threads to prevent galling of the T-bolt and included 3/8" serrated flange nut. Place the 3/8" flange nut on the T-bolt and finger tighten. Repeat STEP 3 until all L-Feet are secured to the Rail with a T-bolt. Adjust the level and height of the Rail and torque each bolt to 30ft-lbs.

FASTER INSTALLATION. 25-YEAR WARRANTY.

FOR QUESTIONS OR CUSTOMER SERVICE VISIT UNIRAC.COM OR CALL (505) 248-2702

THE COMPLETE ROOF ATTACHMENT SOLUTION

FOR QUESTIONS OR CUSTOMER SERVICE VISIT UNIRAC.COM OR CALL (505) 248-2702