



Scott E. Wyssling, PE
Coleman D. Larsen, SE, PE
Gregory T. Elvestad, PE

76 North Meadowbrook Drive
Alpine, UT 84004
office (201) 874-3483
swyssling@wysslingconsulting.com

September 06, 2023
Revised September 6, 2023

Current Insight
2852 W. Amini Way
South Jordan, UT 84095

Re: Engineering Services
Gentry Residence
108 Wendywood Drive, Angier NC
8.800 kW System

To Whom It May Concern:

We have received information regarding solar panel installation on the roof of the above referenced structure. Our evaluation of the structure is to verify the existing capacity of the roof system and its ability to support the additional loads imposed by the proposed solar system.

A. Site Assessment Information

1. Site visit documentation identifying attic information including size and spacing of framing for the existing roof structure.
2. Design drawings of the proposed system including a site plan, roof plan and connection details for the solar panels. This information will be utilized for approval and construction of the proposed system.

B. Description of Structure:

Roof Framing: Assumed prefabricated wood trusses at 24" on center. All truss members are constructed of 2x4 dimensional lumber.
Roof Material: Composite Asphalt Shingles
Roof Slope: 22 degrees
Attic Access: Inaccessible
Foundation: Permanent

C. Loading Criteria Used

- **Dead Load**
 - Existing Roofing and framing = 7 psf
 - New Solar Panels and Racking = 3 psf
 - TOTAL = 10 PSF
- **Live Load** = 20 psf (reducible) – 0 psf at locations of solar panels
- **Ground Snow Load** = 15 psf
- **Wind Load** based on ASCE 7-10
 - Ultimate Wind Speed = 119 mph (based on Risk Category II)
 - Exposure Category C

Analysis performed of the existing roof structure utilizing the above loading criteria is in accordance with the 2018 North Carolina Residential Code, including provisions allowing existing structures to not require strengthening if the new loads do not exceed existing design loads by 105% for gravity elements and 110% for seismic elements. This analysis indicates that the existing framing will support the additional panel loading without damage, if installed correctly.

D. Solar Panel Anchorage

1. The solar panels shall be mounted in accordance with the most recent Ironridge installation manual. If during solar panel installation, the roof framing members appear unstable or deflect non-uniformly, our office should be notified before proceeding with the installation.
2. The maximum allowable withdrawal force for a $\frac{5}{16}$ " lag screw is 229 lbs per inch of penetration as identified in the National Design Standards (NDS) of timber construction specifications. Based on a minimum penetration depth of $2\frac{1}{2}$ ", the allowable capacity per connection is greater than the design withdrawal force (demand). Considering the variable factors for the existing roof framing and installation tolerances, the connection using one $\frac{5}{16}$ " diameter lag screw with a minimum of $2\frac{1}{2}$ " embedment will be adequate and will include a sufficient factor of safety.
3. Considering the wind speed, roof slopes, size and spacing of framing members, and condition of the roof, the panel supports shall be placed no greater than 48" on center.

Based on the above evaluation, this office certifies that with the racking and mounting specified, the existing roof system will adequately support the additional loading imposed by the solar system. This evaluation is in conformance with the 2018 North Carolina Residential Code, current industry standards, and is based on information supplied to us at the time of this report.

Should you have any questions regarding the above or if you require further information do not hesitate to contact me.

Very truly yours,

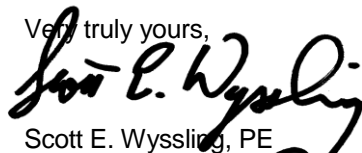

Scott E. Wyssling, PE
North Carolina License No. 46546
North Carolina COA P-2308



Wyssling Consulting, PLLC
76 N Meadowbrook Drive Alpine UT 84004
North Carolina COA # P-2308

Signed 9/06/2023

THIS PLAN HAS BEEN ELECTRONICALLY SIGNED AND SEALED BY SCOTT WYSSLING, PE USING A DIGITAL SIGNATURE AND DATE. PRINTED COPIES OF THIS DOCUMENT ARE NOT CONSIDERED SIGNED AND SEALED AND THE SIGNATURE MUST BE VERIFIED ON ANY ELECTRONIC COPIES

CELIA GENTRY RESIDENCE

NEW PHOTOVOLTAIC ROOF MOUNT SYSTEM PROJECT - 8.800 KW DC / 7.600 KW AC

PROJECT INFORMATION

PROPERTY OWNER
NAME: CELIA GENTRY

CONTRACTOR
NAME: BYLD

DESIGN SPECIFICATIONS

OCCUPANCY: R-3
CONSTRUCTION TYPE: SINGLE FAMILY RESIDENCE
ZONING: RESIDENTIAL
WIND EXPOSURE: C
AHJ: HARNETT COUNTY
UTILITY: DUKE ENERGY PROGRESS

APPLICABLE CODES & STANDARDS

NORTH CAROLINA RESIDENTIAL CODE 2018 (NCRC 2018)
NORTH CAROLINA BUILDING CODE 2018 (NCBC 2018)
NORTH CAROLINA FIRE CODE 2018 (NCFC 2018)
NATIONAL ELECTRICAL CODE, NEC 2020 CODE BOOK, NFPA 70

TYPE OF INTERCONNECTION: LINE SIDE TAP IN THE MSP

SCOPE OF WORK
TYPE OF SYSTEM: ROOF MOUNT

SYSTEM SIZE: STC: 22 X 400W = 8.800kW
PTC: 22 X 383W = 8.426kW
(22) REC SOLAR REC ALPHA REC400AA PURE-R [BLK] (400W) MODULES
(1) TESLA SOLAR 7.6KW INVERTER
(1) 60A FUSED AC DISCONNECT WITH 40A FUSES

MSP UPGRADE: NO
MAIN BREAKER DERATE: NO



RACKING & MOUNTING

PV ATTACHMENT TYPE: IRONRIDGE FLASHVUE FOR COMP SHINGLE ROOF

RACKING TYPE: IRONRIDGE XR10 RAIL ROOF MOUNT RACKING HARDWARE



Wyssling Consulting, PLLC
76 N Meadowbrook Drive Alpine UT 84004
North Carolina COA # P-2308
Signed 9/06/2023

THIS PLAN HAS BEEN ELECTRONICALLY SIGNED AND SEALED BY SCOTT WYSSLING, PE USING A DIGITAL SIGNATURE AND DATE. PRINTED COPIES OF THIS DOCUMENT ARE NOT CONSIDERED SIGNED AND SEALED AND THE SIGNATURE MUST BE VERIFIED ON ANY ELECTRONIC COPIES

COORDINATES:
35.449445, -78.710468

SHEET #	SHEET NAME
T-1	COVER SHEET
T-2	PLAN NOTES
PV-1	SITE PLAN LAYOUT
PV-2	ATTACHMENT DETAILS
PV-3	MOUNTING DETAILS
E-1	ELECTRICAL DIAGRAM
E-1.1	ELECTRICAL CALCULATION
E-2	WARNING LABELS
S-1	SPEC SHEET
S-2	SPEC SHEET
S-3	SPEC SHEET
S-4	SPEC SHEET

AERIAL VIEW



BYLD BETTER

CONTRACTOR

BYLD

**ADDRESS: 1213W
MOOREHEAD ST,
STE 500 CHARLOTTE,
NC 28208
LICENSE #:**

DESIGNER: OSL

**CELIA GENTRY
RESIDENCE**

108 WENDYWOOD DR,
ANGIER,
NC 27501

APN: 0681682518.000

DATE: 9/6/2023

DESIGN BY

Complete Solar
A Brighter Way.

SHEET
T-1
COVER SHEET

1.1. PROJECT NOTES:

- 1.2. THIS PHOTOVOLTAIC (PV) SYSTEM SHALL COMPLY WITH THE NATIONAL ELECTRICAL CODE (NEC) ARTICLE 690, ALL MANUFACTURER'S LISTING AND INSTALLATION INSTRUCTIONS, AND THE RELEVANT CODES AS SPECIFIED BY THE AUTHORITY HAVING JURISDICTION'S (AHJ) APPLICABLE CODES.
- 1.3. THE UTILITY INTERCONNECTION APPLICATION MUST BE APPROVED AND PV SYSTEM INSPECTED PRIOR TO PARALLEL OPERATION
- 1.4. GROUND FAULT DETECTION AND INTERRUPTION (GFDI) DEVICE IS INTEGRATED WITH THE INVERTER IN ACCORDANCE WITH NEC 690.5(A)
- 1.5. ALL PV SYSTEM COMPONENTS; MODULES, UTILITY-INTERACTIVE INVERTERS, AND SOURCE CIRCUIT COMBINER BOXES ARE IDENTIFIED AND LISTED FOR USE IN PHOTOVOLTAIC SYSTEMS AS REQUIRED BY NEC 690.4 & NEC 690.60: PV MODULES: UL1703, IEC61730, AND IEC61215, AND NFPA 70 CLASS C FIRE INVERTERS: UL 1741 CERTIFIED, IEEE 1547, 929, 519 COMBINER BOX(ES): UL 1703 OR UL 1741 ACCESSORY
- 1.6. MAX DC VOLTAGE CALCULATED USING MANUFACTURER PROVIDED TEMP COEFFICIENT FOR VOC. IF UNAVAILABLE, MAX DC VOLTAGE CALCULATED ACCORDING TO NEC 690.7.
- 1.7. ALL INVERTERS, PHOTOVOLTAIC MODULES, PHOTOVOLTAIC PANELS, AND SOURCE CIRCUIT COMBINERS INTENDED FOR USE IN A PHOTOVOLTAIC POWER SYSTEM WILL BE IDENTIFIED AND LISTED FOR THE APPLICATION PER 690.4 (D). SHALL BE INSTALLED ACCORDING TO ANY INSTRUCTIONS FROM LISTING OR LABELING [NEC 110.3].
- 1.8. ALL SIGNAGE TO BE PLACED IN ACCORDANCE WITH LOCAL BUILDING CODE. IF EXPOSED TO SUNLIGHT, IT SHALL BE UV RESISTANT. ALL PLAQUES AND SIGNAGE WILL BE INSTALLED AS REQUIRED BY THE NEC AND AHJ.

1.9. SCOPE OF WORK:

- 1.10. PRIME CONTRACTOR IS RESPONSIBLE FOR THE DESIGN AND SPECIFICATIONS OF THE GRID-TIED PHOTOVOLTAIC SYSTEM RETROFIT. PRIME CONTRACTOR WILL BE RESPONSIBLE FOR COLLECTING EXISTING ONSITE REQUIREMENTS TO DESIGN, SPECIFY, AND INSTALL THE EXTERIOR ROOF-MOUNTED PORTION OF THE PHOTOVOLTAIC SYSTEMS DETAILED IN THIS DOCUMENT.

1.11. WORK INCLUDES:

- 1.12. PV ROOF ATTACHMENTS - IRONRIDGE FLASHVUE FOR COMP SHINGLE
- 1.13. PV RACKING SYSTEM INSTALLATION - IRONRIDGE XR10 RAIL ROOF MOUNT RACKING HARDWARE
- 1.14. PV MODULE AND INVERTER INSTALLATION - REC SOLAR REC ALPHA REC400AA PURE-R [BLK] (400W) MODULES/ TESLA SOLAR 7.6KW INVERTER
- 1.15. PV EQUIPMENT GROUNDING
- 1.16. PV SYSTEM WIRING TO A ROOF-MOUNTED JUNCTION BOX
- 1.17. PV LOAD CENTERS (IF INCLUDED)
- 1.18. PV METERING/MONITORING (IF INCLUDED)
- 1.19. PV DISCONNECTS
- 1.20. PV GROUNDING ELECTRODE & BONDING TO (E) GEC
- 1.21. PV FINAL COMMISSIONING
- 1.22. (E) ELECTRICAL EQUIPMENT RETROFIT FOR PV
- 1.23. SIGNAGE PLACED IN ACCORDANCE WITH LOCAL BUILDING CODE

1.24. SITE NOTES:

- 1.25. A LADDER WILL BE IN PLACE FOR INSPECTION IN COMPLIANCE WITH OSHA REGULATIONS.
- 1.26. THE PV MODULES ARE CONSIDERED NON-COMBUSTIBLE AND THIS SYSTEM IS A UTILITY INTERACTIVE SYSTEM WITH NO STORAGE BATTERIES.
- 1.27. THE SOLAR PV INSTALLATION WILL NOT OBSTRUCT ANY PLUMBING, MECHANICAL, OR BUILDING ROOF VENTS.
- 1.28. PROPER ACCESS AND WORKING CLEARANCE AROUND EXISTING AND PROPOSED ELECTRICAL EQUIPMENT WILL BE PROVIDED AS PER SECTION NEC 110.26.
- 1.29. ROOF COVERINGS SHALL BE DESIGNED, INSTALLED, AND MAINTAINED IN ACCORDANCE WITH THIS CODE AND THE APPROVED MANUFACTURER'S INSTRUCTIONS SUCH THAT THE ROOF COVERING SERVES TO PROTECT THE BUILDING OR STRUCTURE.

1.30. EQUIPMENT LOCATIONS:

- 1.31. ALL EQUIPMENT SHALL MEET MINIMUM SETBACKS AS REQUIRED BY NEC 110.26.
- 1.32. WIRING SYSTEMS INSTALLED IN DIRECT SUNLIGHT MUST BE RATED FOR EXPECTED OPERATING TEMPERATURE AS SPECIFIED BY NEC 690.31 (A),(C) AND NEC TABLES 310.15 (B)(2)(A) AND 310.15 (B)(3)(C)
- 1.33. JUNCTION AND PULL BOXES PERMITTED INSTALLED UNDER PV MODULES ACCORDING TO NEC 690.34.
- 1.34. ADDITIONAL AC DISCONNECT(S) SHALL BE PROVIDED WHERE THE INVERTER IS NOT WITHIN SIGHT OF THE AC SERVICING DISCONNECT.
- 1.35. ALL EQUIPMENT SHALL BE INSTALLED ACCESSIBLE TO QUALIFIED PERSONNEL ACCORDING TO NEC APPLICABLE CODES.
- 1.36. ALL COMPONENTS ARE LISTED FOR THEIR PURPOSE AND RATED FOR OUTDOOR USAGE WHEN APPROPRIATE.

1.37. STRUCTURAL NOTES:

- 1.38. RACKING SYSTEM
- 1.39. PV ARRAY WILL BE INSTALLED ACCORDING TO CODE-COMPLIANT INSTALLATION MANUAL. TOP CLAMPS REQUIRE A DESIGNATED SPACE BETWEEN MODULES, AND RAILS MUST ALSO EXTEND
- 1.40. A MINIMUM DISTANCE BEYOND EITHER EDGE OF THE ARRAY/SUBARRAY, ACCORDING TO RAI MANUFACTURER'S INSTRUCTIONS.
- 1.41. JUNCTION BOX WILL BE INSTALLED PER MANUFACTURERS' SPECIFICATIONS. IF ROOF-PENETRATING TYPE, IT SHALL BE FLASHED SEALED PER LOCAL REQUIREMENTS.
- 1.42. ROOFTOP PENETRATIONS FOR PV RACEWAY WILL BE COMPLETED AND SEALED W/ APPROVED CHEMICAL SEALANT PER CODE BY A LICENSED CONTRACTOR.
- 1.43. ALL PV RELATED ROOF ATTACHMENTS TO BE SPACED NO GREATER THAN THE SPAN DISTANCE SPECIFIED BY THE RACKING MANUFACTURER.
- 1.44. WHEN POSSIBLE, ALL PV RELATED RACKING ATTACHMENTS WILL BE STAGGERED AMONGST THE ROOF FRAMING MEMBERS.

1.45. WIRING & CONDUIT NOTES:

- 1.46. ALL CONDUIT AND WIRE WILL BE LISTED AND APPROVED FOR THEIR PURPOSE. CONDUIT AND WIRE SPECIFICATIONS ARE BASED ON MINIMUM CODE REQUIREMENTS AND ARE NOT MEANT TO LIMIT UP-SIZING.
- 1.47. CONDUCTORS SIZED ACCORDING TO NEC 690.8, NEC 690.7.
- 1.48. VOLTAGE DROP LIMITED TO 1.5%.
- 1.49. DC WIRING LIMITED TO MODULE FOOTPRINT. INVERTER WIRING SYSTEMS SHALL BE LOCATED AND SECURED UNDER THE ARRAY W/ SUITABLE WIRING CLIPS.
- 1.50. AC CONDUCTORS COLORED OR MARKED AS FOLLOWS: PHASE A OR L1- BLACK PHASE B OR L2- RED, OR OTHER CONVENTION IF THREE PHASE PHASE C OR L3- BLUE, YELLOW, ORANGE**, OR OTHER CONVENTION NEUTRAL- WHITE OR GREY IN 4-WIRE DELTA CONNECTED SYSTEMS THE PHASE WITH HIGHER VOLTAGE TO BE MARKED ORANGE [NEC 110.15

1.51. GROUNDING NOTES:

- 1.52. GROUNDING SYSTEM COMPONENTS SHALL BE LISTED FOR THEIR PURPOSE, AND GROUNDING DEVICES EXPOSED TO THE ELEMENTS SHALL BE RATED FOR SUCH USE.
- 1.53. PV EQUIPMENT SHALL BE GROUNDED ACCORDING TO NEC 690.43 AND MINIMUM NEC TABLE 250.122.
- 1.54. METAL PARTS OF MODULE FRAMES, MODULE RACKING, AND ENCLOSURES CONSIDERED GROUNDED IN ACCORD WITH 250.134 AND 250.136(A).
- 1.55. EQUIPMENT GROUNDING CONDUCTORS SHALL BE SIZED ACCORDING TO NEC 690.45 AND INVERTER MANUFACTURER'S INSTRUCTIONS.

- 1.56. EACH MODULE WILL BE GROUNDED USING WEEB GROUNDING CLIPS AS SHOWN IN MANUFACTURER DOCUMENTATION AND APPROVED BY THE AHJ. IF WEEBS ARE NOT USED, MODULE GROUNDING LUGS MUST BE INSTALLED AT THE SPECIFIED GROUNDING LUG HOLES PER THE MANUFACTURER'S INSTALLATION REQUIREMENTS.
- 1.57. THE GROUNDING CONNECTION TO A MODULE SHALL BE ARRANGED SUCH THAT THE REMOVAL OF A MODULE DOES NOT INTERRUPT A GROUNDING CONDUCTOR TO ANOTHER MODULE.
- 1.58. GROUNDING AND BONDING CONDUCTORS, IF INSULATED, SHALL BE COLORED GREEN OR MARKED GREEN IF #4 AWG OR LARGER [NEC 250.119]
- 1.59. THE GROUNDING ELECTRODE SYSTEM COMPLIES WITH NEC 690.47 AND NEC 250.50 THROUGH 250.106. IF EXISTING SYSTEM IS INACCESSIBLE, OR INADEQUATE, A GROUNDING ELECTRODE SYSTEM PROVIDED ACCORDING TO NEC 250, NEC 690.47 AND AHJ.
- 1.60. GROUND-FAULT DETECTION SHALL COMPLY WITH NEC 690.5 IN GENERAL AND NEC 690.5 (A)(1) SPECIFICALLY.

1.61. DISCONNECTION AND OVER-CURRENT PROTECTION NOTES:

- 1.62. DISCONNECTING SWITCHES SHALL BE WIRED SUCH THAT WHEN THE SWITCH IS OPENED THE CONDUCTORS REMAINING ENERGIZED ARE CONNECTED TO THE TERMINALS MARKED "LINE SIDE" (TYPICALLY THE UPPER TERMINALS).
- 1.63. DISCONNECTS TO BE ACCESSIBLE TO QUALIFIED UTILITY PERSONNEL, BE LOCKABLE, AND BE A VISIBLE-BREAK SWITCH
- 1.64. RAPID SHUTDOWN OF ENERGIZED CONDUCTORS BEYOND 10 FT OF PV ARRAY OR 5 FT INSIDE A BUILDING WITHIN 10 SECONDS. CONTROLLED CONDUCTORS ≤30V AND ≤240VA [NEC 690.12]. LOCATION OF LABEL ACCORDING TO AHJ
- 1.65. ALL OCPD RATINGS AND TYPES SPECIFIED ACCORDING TO NEC 690.8, 690.9, AND 240.
- 1.66. INVERTER BRANCHES CONNECTED TO A SINGLE BREAKER OR GROUPED FUSES IN ACCORDANCE WITH NEC 110.3(B).
- 1.67. IF REQUIRED BY AHJ, SYSTEM WILL INCLUDE ARC-FAULT CIRCUIT PROTECTION ACCORDING TO NEC 690.11 AND UL1699B.

1.68. ELECTRICAL INTERCONNECTION NOTES:

- 1.69. THE SUM OF THE UTILITY OCPD AND INVERTER CONTINUOUS OUTPUT MAY NOT EXCEED 120% OF THE BUSBAR RATING.
- 1.70. WHEN THE SUM OF THE PV SOURCES EQUALS >100% OF THE BUSBAR RATING, PV DEDICATED BACKFEED BREAKERS MUST BE LOCATED OPPOSITE END OF THE BUS FROM THE UTILITY SOURCE OCPD.
- 1.71. AT MULTIPLE PV OUTPUT COMBINER PANEL, THE TOTAL RATING OF ALL OVERCURRENT DEVICES SHALL NOT EXCEED THE AMPACITY OF THE BUSBAR. HOWEVER, THE COMBINED OVERCURRENT DEVICE MAY BE EXCLUDED.
- 1.72. SUPPLY-SIDE TAP INTERCONNECTION SHOULD BE WITH SERVICE ENTRANCE CONDUCTORS.
- 1.73. BACKFEEDING BREAKER FOR UTILITY-INTERACTIVE INVERTER OUTPUT IS EXEMPT FROM ADDITIONAL FASTENING.



Wyssling Consulting, PLLC
 76 N Meadowbrook Drive Alpine UT 84004
 North Carolina COA # P-2308
 Signed 9/06/2023

THIS PLAN HAS BEEN ELECTRONICALLY SIGNED AND SEALED BY SCOTT WYSSLING, PE USING A DIGITAL SIGNATURE AND DATE. PRINTED COPIES OF THIS DOCUMENT ARE NOT CONSIDERED SIGNED AND SEALED AND THE SIGNATURE MUST BE VERIFIED ON ANY ELECTRONIC COPIES

BYLD BETTER

CONTRACTOR

BYLD

ADDRESS: 1213W
 MOOREHEAD ST,
 STE500 CHARLOTTE,
 NC 28208
 LICENSE #:

DESIGNER: OSL

CELIA GENTRY
 RESIDENCE

108 WENDYWOOD DR,
 ANGIER,
 NC 27501

APN:0681682518.000

DATE:9/6/2023

DESIGN BY

Complete Solar

A Brighter Way.

SHEET
 T-2
 PLAN NOTES

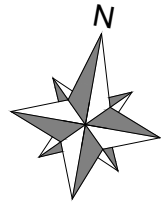

PV SYSTEM SIZE:
8.8 kW DC

108 WENDYWOOD DR

DRIVEWAY

PROPERTY LINE

PROPERTY LINE

PV INTERCONNECTION POINT.
LOCATION OF MAIN SERVICE PANEL,
UTILITY METER, AC DISCONNECT &
STRING INVERTER MOUNTED ON
EXTERIOR WALL OF A SINGLE FAMILY
RESIDENCE.

LOCATION OF "RAPID SHUTDOWN"
AC DISCONNECT NEC 690.12

INV
ACD
UM
MSP

(N) CONDUIT RUN

ROOF OBSTRUCTION

Roof Section 1
Roof Azimuth: 156°
Roof Tilt: 22°

FIRE ROOF LADDER
ACCESS POINT

FIRE ROOF LADDER
ACCESS POINT

(22) REC SOLAR REC ALPHA REC400AA PURE-R [BLK]
(400W)MODULES MOUNTED ON COMP SHINGLE
ROOF

CONSTRUCTION NOTES

1. SOLAR PHOTOVOLTAIC SYSTEM TO BE INSTALLED ON RESIDENTIAL STRUCTURE.
2. THIS PROJECT HAS BEEN DESIGNED IN COMPLIANCE WITH THE IBC SECTION 1609 TO WITHSTAND A BASIC , WIND EXPOSURE B.
3. THE ROOF MEMBERS ARE 2"x4" TRUSSES AT 24" ON CENTER. CONNECTION TO STRUCTURE SHALL NOT BE WITHIN 11" OF NAILING PLATES.
4. THE SOLAR PHOTOVOLTAIC INSTALLATION SHALL NOT OBSTRUCT ANY PLUMBING, MECHANICAL, OR BUILDING ROOF VENTS.
5. ALL CONDUCTORS AND CONDUITS MOUNTED ON ROOF SHALL BE MINIMUM 7/8" ABOVE ROOF SURFACE (INCLUDING CABLES UNDERNEATH MODULES AND RACKING).
6. ROOF ACCESS POINTS SHALL BE PROVIDED PER THE FOLLOWING
 - 6.1. LOCATED IN AREAS NOT REQUIRING PLACEMENT OF GROUND LADDERS OVER OPENINGS SUCH AS DOORS OR WINDOWS.
 - 6.2. LOCATED AT STRONG POINTS OF CONSTRUCTION IN LOCATIONS WHERE ACCESS POINT DOES NOT CONFLICT WITH OVERHEAD OBSTRUCTIONS SUCH AS: TREES, WIRES, OR SIGNS.

PROPERTY LINE

PROPERTY LINE



Wyssling Consulting, PLLC
76 N Meadowbrook Drive Alpine UT 84004
North Carolina COA # P-2308
Signed 9/06/2023

THIS PLAN HAS BEEN ELECTRONICALLY SIGNED AND SEALED BY SCOTT WYSSLING, PE USING A DIGITAL SIGNATURE AND DATE. PRINTED COPIES OF THIS DOCUMENT ARE NOT CONSIDERED SIGNED AND SEALED AND THE SIGNATURE MUST BE VERIFIED ON ANY ELECTRONIC COPIES

BYLD BETTER

CONTRACTOR

BYLD

**ADDRESS: 1213W
MOOREHEAD ST,
STE 500 CHARLOTTE,
NC 28208
LICENSE #:**

DESIGNER: OSL

**CELIA GENTRY
RESIDENCE**

108 WENDYWOOD DR,
ANGIER,
NC 27501

APN: 0681682518.000

DATE: 9/6/2023

DESIGN BY

Complete Solar
A Brighter Way.

SHEET
PV-1
SITE PLAN LAYOUT

LEGEND

	NEW SOLAR PANELS
	AC DISCONNECT
	UTILITY METER
	STRING INVERTER
	MAIN SERVICE PANEL

PV SYSTEM SITE PLAN

SCALE: 3/32" = 1'-0"

BYLD BETTER

CONTRACTOR

BYLD

**ADDRESS: 1213W
MOOREHEAD ST,
STE 500 CHARLOTTE,
NC 28208
LICENSE #:**

DESIGNER: OSL

**CELIA GENTRY
RESIDENCE**

108 WENDYWOOD DR,
ANGIER,
NC 27501

APN: 0681682518.000

DATE: 9/6/2023

DESIGN BY

CompleteSolar
A Brighter Way.

**SHEET
PV-2
ATTACHMENT DETAILS**

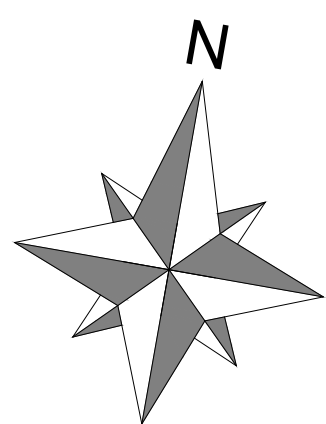

Roof Section 1
Roof Azimuth: 156°
Roof Tilt: 22°

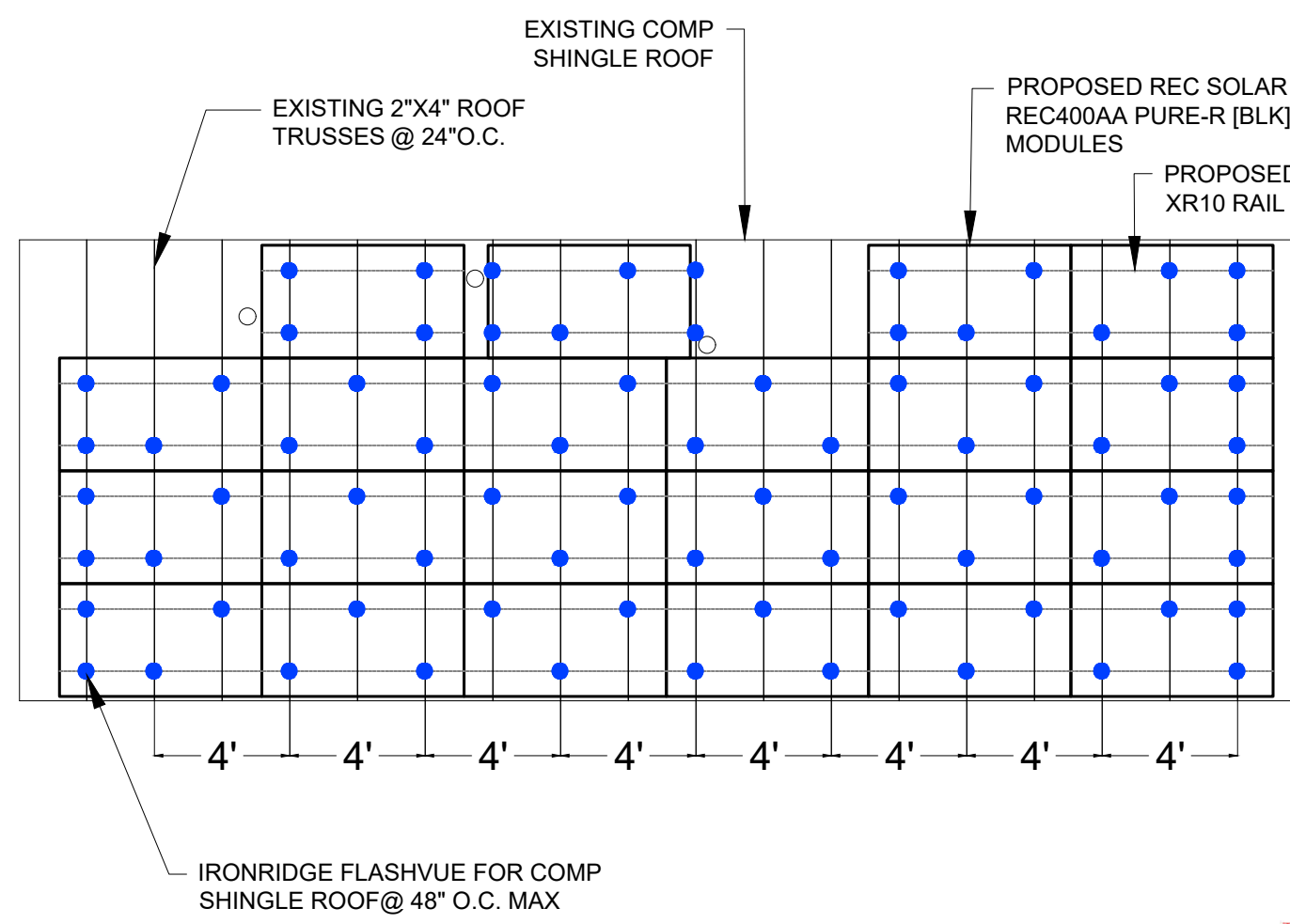

Wyssling Consulting, PLLC
76 N Meadowbrook Drive Alpine UT 84004
North Carolina COA # P-2308
Signed 9/06/2023

THIS PLAN HAS BEEN ELECTRONICALLY SIGNED AND SEALED BY SCOTT WYSSLING, PE USING A DIGITAL SIGNATURE AND DATE. PRINTED COPIES OF THIS DOCUMENT ARE NOT CONSIDERED SIGNED AND SEALED AND THE SIGNATURE MUST BE VERIFIED ON ANY ELECTRONIC COPIES

PV SYSTEM MOUNTING DETAILS

SCALE: 3/16" = 1'-0"

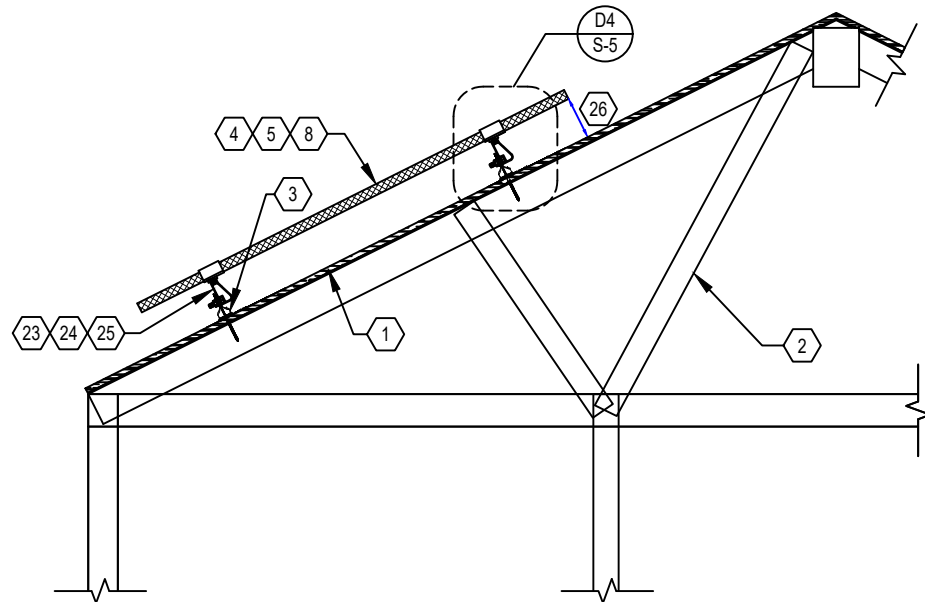

D1 RACKING DETAIL (TRANSVERSE)
NOT TO SCALE

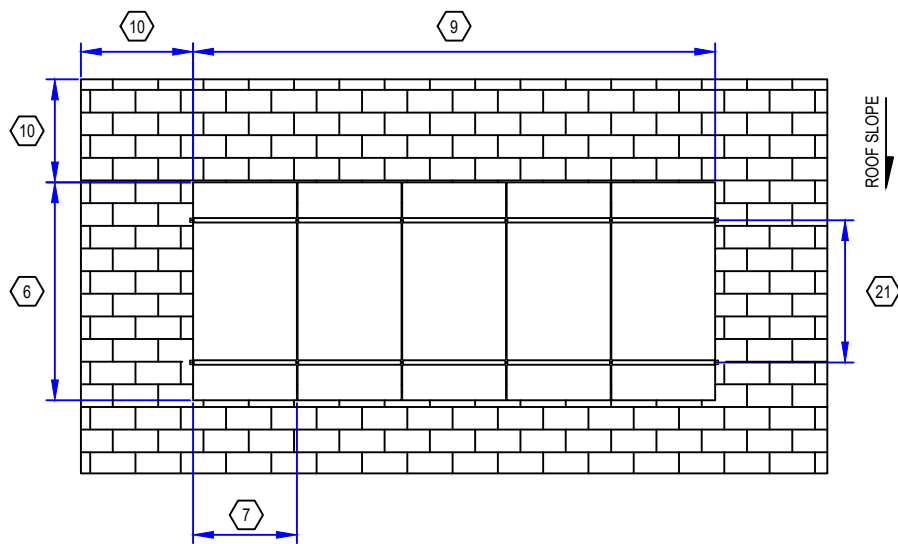

D3 RACKING DETAIL (TOP)
NOT TO SCALE

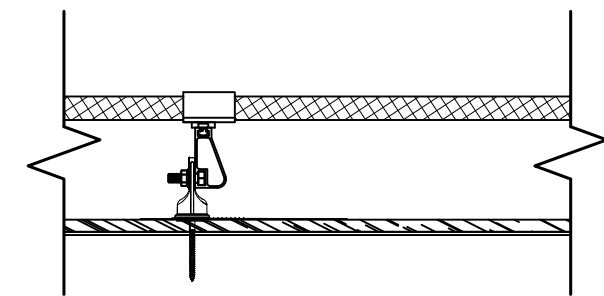

D4 DETAIL (TRANSVERSE)
NOT TO SCALE

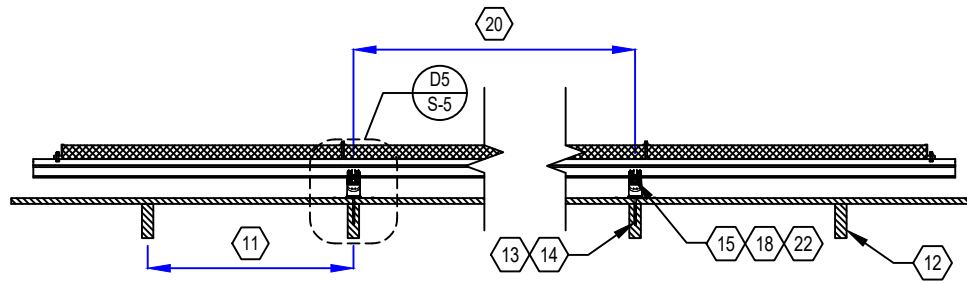

D2 RACKING DETAIL (LONGITUDINAL)
NOT TO SCALE

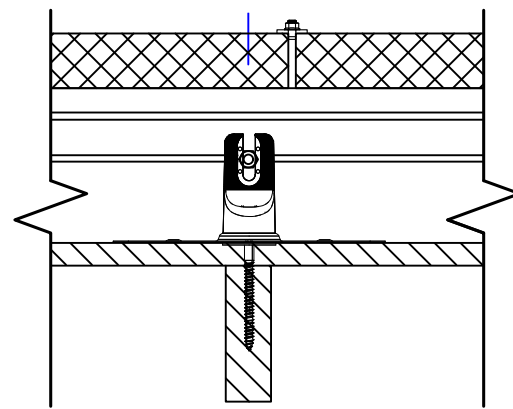

D5 DETAIL (LONGITUDINAL)
NOT TO SCALE



Wyssling Consulting, PLLC
76 N Meadowbrook Drive Alpine UT 84004
North Carolina COA # P-2308
Signed 9/06/2023

THIS PLAN HAS BEEN ELECTRONICALLY SIGNED AND SEALED BY SCOTT WYSSLING, PE USING A DIGITAL SIGNATURE AND DATE. PRINTED COPIES OF THIS DOCUMENT ARE NOT CONSIDERED SIGNED AND SEALED AND THE SIGNATURE MUST BE VERIFIED ON ANY ELECTRONIC COPIES

1. ROOF MATERIAL: COMP SHINGLE
2. ROOF STRUCTURE: TRUSSES
3. ATTACHMENT TYPE: IRONRIDGE FLASHVUE
4. MODULE MANUFACTURER: REC SOLAR
5. MODULE MODEL: REC ALPHA REC400AA PURE-R [BLK] (400W)
6. MODULE LENGTH: 68.11"
7. MODULE WIDTH: 44.01"
8. MODULE WEIGHT: 47.39 LBS.
9. SEE SHEET S-1 FOR DIMENSION(S)
10. MIN. FIRE OFFSET
11. TRUSSES SPACING: 24" O.C.
12. TRUSSES SIZE: 2"X4" NOMINAL
13. LAG BOLT DIAMETER: 5/16 IN.
14. LAG BOLT EMBEDMENT: 2.5 IN.
15. TOTAL # OF ATTACHMENTS: 78
16. TOTAL AREA: 457.95 SQ. FT.
17. TOTAL WEIGHT: 1042.58LBS.
18. WEIGHT PER ATTACHMENT: 13.37 LBS.
19. DISTRIBUTED LOAD: 2.28 PSF
20. MAX. HORIZONTAL STANDOFF: 48 IN.
21. MAX. VERTICAL STANDOFF:
LANDSCAPE: 26 IN., PORTRAIT: 44 IN.
22. STANDOFF STAGGERING: YES
23. RAIL MANUFACTURER AND MODEL (OR EQUIV.): IRONRIDGE XR10 RAIL
24. RAIL WEIGHT: 0.436 PLF.
25. MAX. TRUSSES SPAN: 12 FT.
26. MODULE CLEARANCE: 3 IN. MIN., 6 IN. MAX.



CONTRACTOR

BYLD
ADDRESS: 1213W MOOREHEAD ST,
STE 500 CHARLOTTE,
NC 28208
LICENSE #:

DESIGNER: OSL

CELIA GENTRY RESIDENCE

108 WENDYWOOD DR,
ANGIER,
NC 27501

APN: 0681682518.000
DATE: 9/6/2023

DESIGN BY



SHEET
PV-3
MOUNTING DETAILS

BYLD BETTER

METER # 339604170
 MAIN SERVICE PANEL
 SUPPLY SIDE TAP
 NEC 705.11 SUPPLY SIDE.
 POWER PRODUCTION SOURCES

CONTRACTOR

BYLD

**ADDRESS: 1213W
 MOOREHEAD ST,
 STE 500 CHARLOTTE,
 NC 28208
 LICENSE #:**

DESIGNER: OSL

**CELIA GENTRY
 RESIDENCE**

108 WENDYWOOD DR,
 ANGIER,
 NC 27501

APN: 0681682518.000

DATE: 9/6/2023

DESIGN BY

CompleteSolar
 A Brighter Way.

SHEET
 E-1
 ELECTRICAL DIAGRAM

(N) (22) REC SOLAR REC ALPHA REC400AA
 PURE-R [BLK] (400W) MODULES
 11 MODULES IN BRANCH #1

BRANCH #1

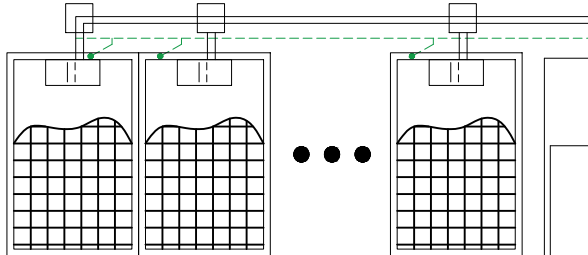

11 MODULES IN BRANCH #2

BRANCH #2

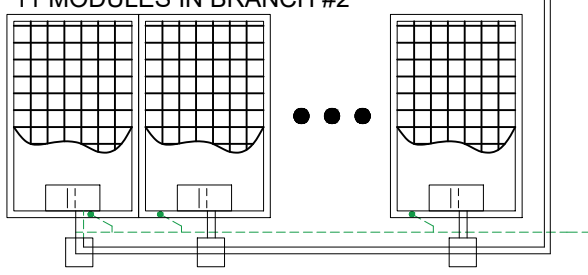

NOTE: IN BETWEEN EACH ARRAY THE EMT IS USED AS THE
 GROUNDING / BONDING, GROUND CLAMPS ARE AT EACH
 END OF THE EMT CONDUIT WITH THE WIRE THEN FREE
 AIR'D TO THE GROUND CLAMP ON THE RACKING RAIL

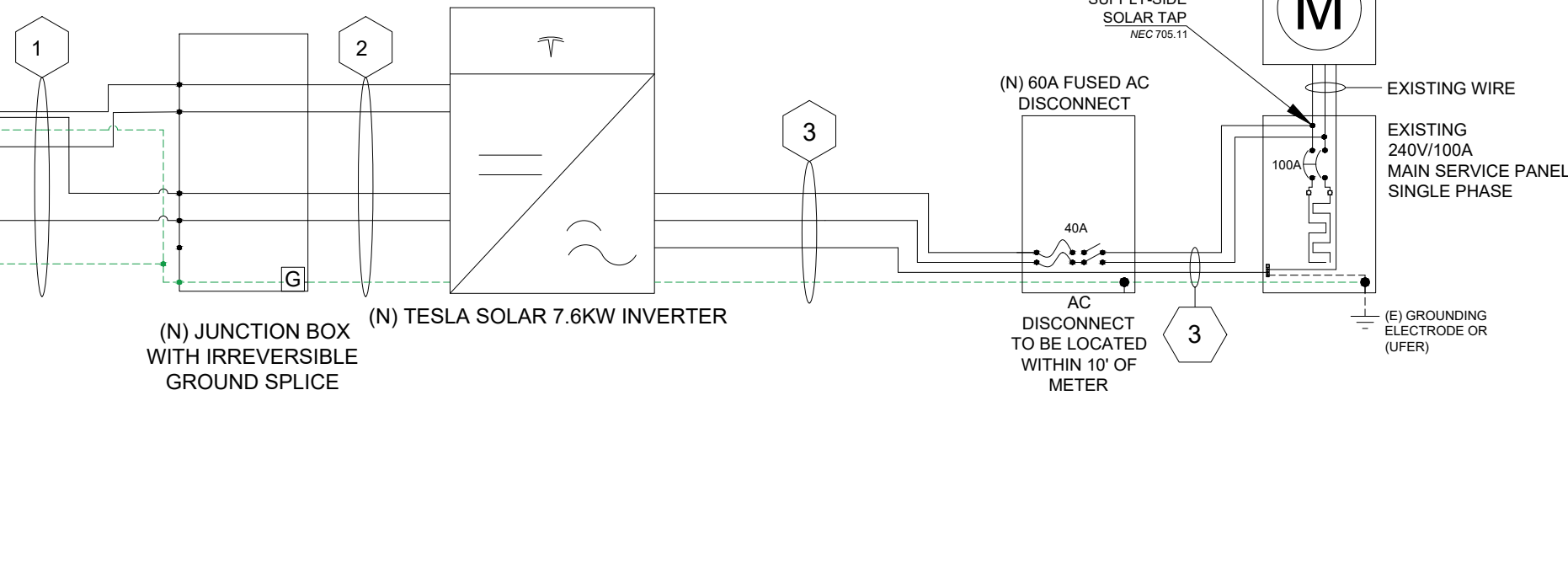

PV Module Ratings @ STC	
Module Make/Model	REC SOLAR REC ALPHA REC400AA PURE-R [BLK] (400W)
Max Power-Point Current (Imp)	8.20A
Max Power-Point Voltage (Vmp)	48.8V
Open-Circuit Voltage (Voc)	58.9V
Short-Circuit Current (Isc)	8.80A
Max Series Fuse (OCPD)	25A
Nominal Maximum Power at STC (Pmax)	400W
Maximum System Voltage	1000V
Voc Temperature Coefficient	-0.24 %/C

SYSTEM SUMMARY		
	BRANCH #1	BRANCH #2
MODULES PER BRANCH	11	11
SHORT-CIRCUIT CURRENT (ISC)	8.80A	8.80A
ARRAY STC POWER	8800W	
ARRAY PTC POWER	8184W	
MAX CONTINUOUS OUTPUT CURRENT	32.00A	
MAX CONTINUOUS OUTPUT POWER	7600W	
DERATED (CEC) AC POWER	8215.3W	

Inverter Ratings	
Inverter Make/Model	TESLA SOLAR 7.6KW INVERTER
Max DC Volt Rating	600V
Max Continuous Output Power	7600W
Max Nominal Voltage	240V
Max Continuous output Current	32A
Max OCPD Rating	40A

DESIGN TEMPERATURES	
ASHRAE EXTREME LOW	-10°C
ASHRAE 2% HIGH	36°C

BYLD BETTER

CONTRACTOR

BYLD

**ADDRESS:1213W
MOOREHEAD ST,
STE500 CHARLOTTE,
NC 28208
LICENSE #:**

DESIGNER: OSL

**CELIA GENTRY
RESIDENCE**

108 WENDYWOOD DR,
ANGIER,
NC 27501

APN:0681682518.000

DATE:9/6/2023

DESIGN BY

CompleteSolar
A Brighter Way.

SHEET
E-1.1
ELECTRICAL CALCULATION

Conduit and Conductor Schedule					
Tag	Description	Wire Gauge	# of Conductors	Conduit Type	Conduit Size
1	PV Cable	10 AWG	2	N/A - Free Air	N/A - Free Air
1	Bare Copper Ground (EGC/GEC)	6 AWG	1	N/A - Free Air	N/A - Free Air
2	THWN-2	10 AWG	4(2V+, 2V-)	EMT	3/4"
2	THWN-2 - Ground	10 AWG	1	EMT	3/4"
3	THWN-2	6 AWG	3(L1, L2, N)	EMT	3/4"
3	THWN-2 - Ground	6 AWG	1	EMT	3/4"

⚠ WARNING
ELECTRICAL SHOCK HAZARD
TERMINALS ON LINE AND LOAD SIDES MAY BE ENERGIZED IN THE OPEN POSITION

LABEL LOCATION:
INVERTER(S), AC DISCONNECT(S), AC COMBINER PANEL (IF APPLICABLE).
PER CODE(S): NEC : 690.13(B), NEC 2014: 690.17(E), NEC : 690.17(4)

RAPID SHUTDOWN SWITCH FOR SOLAR PV SYSTEM

LABEL LOCATION:
UTILITY SERVICE ENTRANCE/METER, INVERTER/DC DISCONNECT IF REQUIRED BY LOCAL AHJ, OR OTHER LOCATIONS AS REQUIRED BY LOCAL AHJ.
PER CODE(S): NEC : 690.56(C)(3), NEC : 690.12, NEC 690.56, IFC 2012: 605.11.1, IFC 2018: 1204.5.3

⚠ WARNING
POWER SOURCE OUTPUT CONNECTION
DO NOT RELOCATE THIS OVERCURRENT DEVICE

LABEL LOCATION:
ADJACENT TO PV BREAKER (IF APPLICABLE).
PER CODE(S): NEC : 705.12(B)(3)(2), NEC : 705.12(B)(2)(3)(b), NEC : 705.12(D)(2)(3)(b)

⚠ WARNING
THIS EQUIPMENT FED BY MULTIPLE SOURCES. TOTAL RATING OF ALL OVERCURRENT DEVICES, EXCLUDING MAIN SUPPLY OVERCURRENT DEVICE, SHALL NOT EXCEED AMPACITY OF BUSBAR.

LABEL LOCATION:
AC DISCONNECT(S), PHOTOVOLTAIC SYSTEM POINT OF INTERCONNECTION.
PER CODE(S): NEC : 690.54, NEC 2014: 690.54, NEC 2011: 690.54

MAIN PHOTOVOLTAIC SYSTEM DISCONNECT

LABEL LOCATION: PV SYSTEM DISCONNECT
PER CODE(S): NEC 690.13(B)

⚠ WARNING
DUAL POWER SOURCE
SECOND SOURCE IS PHOTOVOLTAIC SYSTEM

LABEL LOCATION:
MAIN SERVICE PANEL (IF APPLICABLE).
PER CODE(S): NEC : 705.12(C) & 690.59

GENERATION DISCONNECT SWITCH
MAXIMUM AC OPERATING CURRENT: 32.00 AMPS
NOMINAL OPERATING AC VOLTAGE: 240.0 VAC

LABEL LOCATION:
AC DISCONNECT(S), PHOTOVOLTAIC SYSTEM POINT OF INTERCONNECTION.
PER CODE(S): NEC : 690.54

SOLAR PV SYSTEM EQUIPPED WITH RAPID SHUTDOWN

TURN RAPID SHUTDOWN SWITCH TO THE "OFF" POSITION TO SHUT DOWN PV SYSTEM AND REDUCE SHOCK HAZARD IN THE ARRAY.

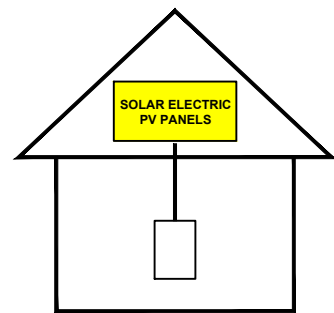

LABEL LOCATION:
ON OR NO MORE THAT 3 M (10 FT) FROM THE SERVICE DISCONNECTING MEANS TO WHICH THE PV SYSTEMS ARE CONNECTED.
PER CODE(S): NEC : 690.56(C)(1)(a)

CAUTION:
POWER TO THIS BUILDING IS ALSO SUPPLIED FROM THE FOLLOWING SOURCES WITH DISCONNECTS AS SHOWN

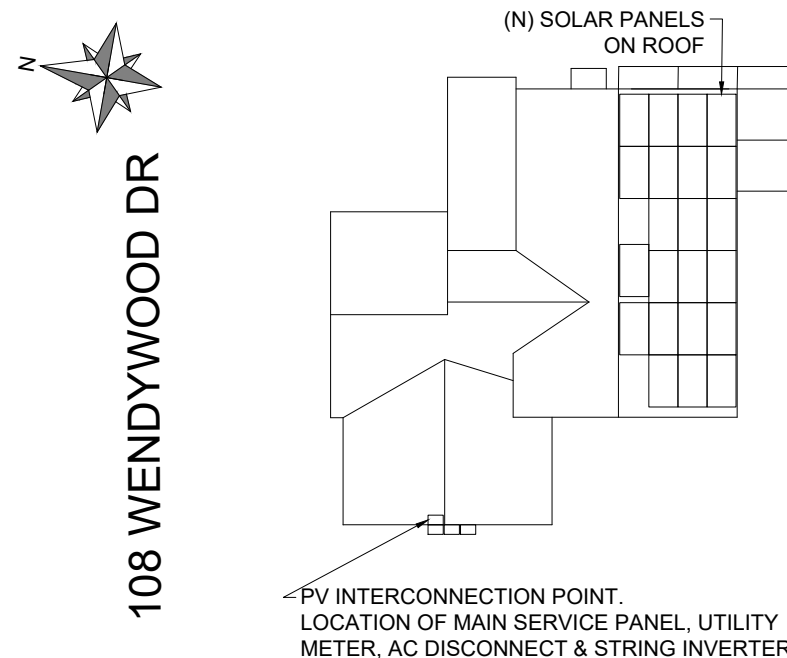

PERMANENT SIGNAGE NOTES:

1. NOT ALL PLACARDS SHOWN MAY BE REQUIRED BY LOCAL AHJ. CONTRACTOR TO VERIFY PLACARD REQUIREMENTS WITH LOCAL AHJ BEFORE INSTALLATION.
2. ALL PLAQUES AND SIGNAGE REQUIRED BY THE LATEST EDITION OF THE NATIONAL ELECTRICAL CODE
3. ALTERNATE POWER SOURCE PLACARD SHALL BE METALLIC OR MACHINE PRINTED LETTERS IN A CONTRASTING COLOR TO THE PLAQUE. THIS PLAQUE WILL BE ATTACHED BY POP RIVETS OR SCREWS OR OTHER APPROVED METHOD.
4. DIRECTORY PLACARD MARKING CONTENT AND FORMAT: RED BACKGROUND, WHITE LETTERING, MINIMUM 3/8" LETTER HIEGHT, ALL CAPITAL LETTERS, ARIAL OR SIMILAR FONT, NON BOLD, REFLECTIVE WEATHER RESISTANT MATERIAL SUITABLE FOR THE ENVIRONMENT.



CONTRACTOR

BYLD

ADDRESS:1213W
MOOREHEAD ST,
STE500 CHARLOTTE,
NC 28208
LICENSE #:

DESIGNER: OSL

**CELIA GENTRY
RESIDENCE**

108 WENDYWOOD DR,
ANGIER,
NC 27501

APN:0681682518.000
DATE:9/6/2023

DESIGN BY



SHEET
E-2
WARNING LABELS

SOLAR'S MOST TRUSTED



REC ALPHA PURE-R SERIES PRODUCT SPECIFICATIONS

COMPACT PANEL SIZE
9 A PANEL CURRENT
COMPATIBLE WITH MLPE

430 WP
223 W/m²



REC ALPHA PURE-R SERIES PRODUCT SPECIFICATIONS



GENERAL DATA	
Cell type:	80 half-cut REC heterojunction cells with lead-free, gapless technology
Glass:	3.2 mm solar glass with anti-reflective surface treatment in accordance with EN12150
Backsheet:	Highly resistant polymer (black)
Frame:	Anodized aluminum (black)
Junction box:	4-part, 4 bypass diodes, lead-free IP68 rated, in accordance with IEC 62790
Connectors:	Stäubli MC4 PV-KBT4/KST4 (4 mm ²) in accordance with IEC 62852, IP68 only when connected
Cable:	4 mm ² solar cable, 1.7 + 1.7 m in accordance with EN 50618
Dimensions:	1730 x 1118 x 30 mm (1.93 m ²)
Weight:	21.5 kg
Origin:	Made in Singapore

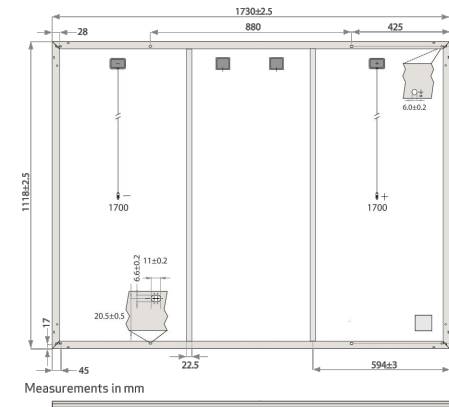

	Product Code: RECxxxAA Pure-R			
	400	410	420	430
Power Output - P _{MAX} (Wp)	400	410	420	430
Watt Class Sorting - (W)	0/+10	0/+10	0/+10	0/+10
Nominal Power Voltage - V _{MPP} (V)	48.8	49.4	50.0	50.5
Nominal Power Current - I _{MPP} (A)	8.20	8.30	8.40	8.52
Open Circuit Voltage - V _{OC} (V)	58.9	59.2	59.4	59.7
Short Circuit Current - I _{SC} (A)	8.80	8.84	8.88	8.91
Power Density (W/m ²)	207	212	218	223
Panel Efficiency (%)	20.7	21.2	21.8	22.3
Power Output - P _{MAX} (Wp)	305	312	320	327
Nominal Power Voltage - V _{MPP} (V)	46.0	46.6	47.1	47.6
Nominal Power Current - I _{MPP} (A)	6.64	6.70	6.80	6.88
Open Circuit Voltage - V _{OC} (V)	55.5	55.8	56.0	56.3
Short Circuit Current - I _{SC} (A)	7.11	7.16	7.20	7.24

Values at standard test conditions (STC: air mass AM1.5, irradiance 1000 W/m², temperature 25°C), based on a production spread with a tolerance of P_{MAX}, V_{OC} & I_{SC} ±3% within one watt class. Nominal module operating temperature (NMOT: air mass AM1.5, irradiance 800 W/m², temperature 20°C, windspeed 1 m/s). * Where xxx indicates the nominal power class (P_{MAX}) at STC above.

MAXIMUM RATINGS	
Operational temperature:	-40 ... +85°C
System voltage:	1000 V
Test load (front):	+7000 Pa (713 kg/m ²)*
Test load (rear):	-4000 Pa (407 kg/m ²)*
Series fuse rating:	25 A
Reverse current:	25 A

* See installation manual for mounting instructions. Design load = Test load / 1.5 (safety factor)

WARRANTY			
	Standard	REC ProTrust	
Installed by an REC Certified Solar Professional	No	Yes	Yes
System Size	All	<25 kW 25-500 kW	
Product Warranty (yrs)	20	25	25
Power Warranty (yrs)	25	25	25
Labor Warranty (yrs)	0	25	10
Power in Year 1	98%	98%	98%
Annual Degradation	0.25%	0.25%	0.25%
Power in Year 25	92%	92%	92%

The REC ProTrust Warranty is only available on panels purchased through an REC Certified Solar Professional installer. Warranty conditions apply. See www.recgroup.com for more details.

Available from:

Founded in 1996, REC Group is an international pioneering solar energy company dedicated to empowering consumers with clean, affordable solar power. As Solar's Most Trusted, REC is committed to high quality, innovation, and a low carbon footprint in the solar materials and solar panels it manufactures. Headquartered in Norway with operational headquarters in Singapore, REC also has regional hubs in North America, Europe, and Asia-Pacific.

CERTIFICATIONS	
IEC 61215-2:2016, IEC 61730:2016, UL 61730	
IEC 62804	PID
IEC 61701	Salt Mist
IEC 62716	Ammonia Resistance
ISO 11925-2	Ignitability (EN13501-1 Class E)
IEC 62782	Dynamic Mechanical Load
IEC 61215-2:2016	Hailstone (35mm)
IEC 62321	Lead-free acc. to RoHS EU 863/2015
IEC 61730-2:2016	Fire Class C (as per UL 790)
ISO 14001, ISO 9001, IEC 45001, IEC 62941	



TEMPERATURE RATINGS*	
Nominal Module Operating Temperature:	44°C (±2°C)
Temperature coefficient of P _{MAX} :	-0.24 %/°C
Temperature coefficient of V _{OC} :	-0.24 %/°C
Temperature coefficient of I _{SC} :	0.04 %/°C

* The temperature coefficients stated are linear values

DELIVERY INFORMATION	
Panels per pallet:	33
Panels per 40 ft GP/high cube container:	858 (26 pallets)
Panels per 13.6m truck:	924 (28 pallets)

LOW LIGHT BEHAVIOUR

Typical low irradiance performance of module at STC:

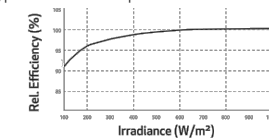

Specifications subject to change without notice. Ref: PM-DS-12-06-Rev-3.1.03.23

BYLD BETTER

CONTRACTOR

BYLD

ADDRESS: 1213W
MOOREHEAD ST,
STE 500 CHARLOTTE,
NC 28208
LICENSE #:

DESIGNER: OSL

CELIA GENTRY
RESIDENCE

108 WENDYWOOD DR,
ANGIER,
NC 27501

APN: 0681682518.000

DATE: 9/6/2023

DESIGN BY

Complete Solar

A Brighter Way.

SHEET
S-1
SPEC SHEET

REC Solar PTE. LTD.
20 Tuas South Ave. 14
Singapore 637312
post@recgroup.com
www.recgroup.com





TESLA

SOLAR INVERTER

3.8 kW | 7.6 kW

Tesla Solar Inverter completes the Tesla home solar system, converting DC power from solar to AC power for home consumption. Tesla's renowned expertise in power electronics has been combined with robust safety features and a simple installation process to produce an outstanding solar inverter that is compatible with both Solar Roof and traditional solar panels. Once installed, homeowners use the Tesla mobile app to manage their solar system and monitor energy consumption, resulting in a truly unique ecosystem experience.

KEY FEATURES

- Built on Powerwall 2 technology for exceptional efficiency and reliability
- Designed to integrate with Tesla Powerwall and Tesla App
- Wi-Fi, Ethernet, and cellular connectivity with easy over-the-air updates
- 3.8 kW and 7.6 kW models available

SOLAR INVERTER

Tesla Solar Inverter provides DC to AC conversion and integrates with the Tesla ecosystem, including Solar Panels, Solar Roof, Powerwall, and vehicle charging, to provide a seamless sustainable energy experience.

KEY FEATURES

- Integrated rapid shutdown, arc fault, and ground fault protection
- 2x the standard number of MPPTs for high production on complex roofs
- No neutral wire simplifies installation



ELECTRICAL SPECIFICATIONS

OUTPUT (AC)	3.8 kW	7.6 kW
Nominal Power	3,800 W	7,600 W
Maximum Apparent Power	3,328 VA at 208 V 3,840 VA at 240 V	6,656 VA at 208 V 7,680 VA at 240 V
Maximum Continuous Current	16 A	32 A
Breaker (Overcurrent Protection)	20 A	40 A
Nominal Power Factor	1 - 0.85 (leading / lagging)	
THD (at Nominal Power)	<5%	
INPUT (DC)		
MPPT	2	4
Input Connectors per MPPT	1-2	1-2-1-2
Maximum Input Voltage	600 VDC	
DC Input Voltage Range	60 - 550 VDC	
DC MPPT Voltage Range ¹	60 - 480 VDC	
Maximum Current per MPPT (I _{mp})	11 A	
Maximum Short Circuit Current per MPPT (I _{sc})	15 A	

PERFORMANCE SPECIFICATIONS

Peak Efficiency ²	97.5%	98.0%
CEC Efficiency ²	97.5%	
Allowable DC/AC Ratio	1.4	
Customer Interface	Tesla Mobile App	
Internet Connectivity	Wi-Fi (2.4 GHz, 802.11 b/g/n), Ethernet, Cellular (LTE/4G) ³	
AC Remote Metering Support	Wi-Fi (2.4 GHz, 802.11 b/g/n), RS-485	
Protections	Integrated arc fault circuit interrupter (AFCI), Rapid Shutdown	
Supported Grid Types	60 Hz, 240 V Split Phase 60 Hz, 208 V Wye	
Required Number of Tesla Solar Shutdown Devices per Solar Module	See <i>Solar Shutdown Device Requirements per Module</i> on page 3	
Warranty	12.5 years	

¹ Maximum current.

² Expected efficiency pending final CEC listing.

³ Cellular connectivity subject to network operator service coverage and signal strength.

MECHANICAL SPECIFICATIONS

Dimensions	660 mm x 411 mm x 158 mm (26 in x 16 in x 6 in)
Weight	52 lb ⁴
Mounting options	Wall mount (bracket)

⁴ Door and bracket can be removed for a mounting weight of 37 lb.

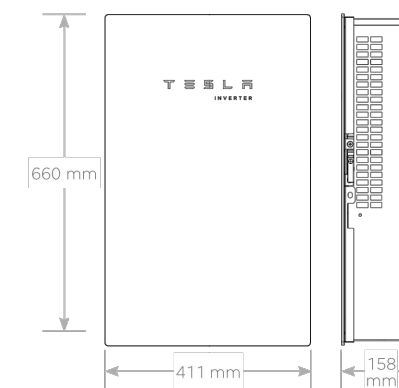

ENVIRONMENTAL SPECIFICATIONS

Operating Temperature ⁵	-30°C to 45°C (-22°F to 113°F)
Operating Humidity (RH)	Up to 100%, condensing
Storage Temperature	-30°C to 70°C (-22°F to 158°F)
Maximum Elevation	3000 m (9843 ft)
Environment	Indoor and outdoor rated
Enclosure Rating	Type 3R
Ingress Rating	IP55 (Wiring compartment)
Pollution Rating	PD2 for power electronics and terminal wiring compartment, PD3 for all other components
Operating Noise @ 1 m	< 40 db(A) nominal, < 50 db(A) maximum

⁵ For the 7.6 kW Solar Inverter, performance may be de-rated to 6.2 kW at 240 V or 5.37 kW at 208 V when operating at temperatures greater than 45°C.

COMPLIANCE INFORMATION

Grid Certifications	UL 1741, UL 1741 SA, IEEE 1547, IEEE 1547.1
Safety Certifications	UL 1699B, UL 1741, UL 1998 (US)
Emissions	EN 61000-6-3 (Residential), FCC 47CFR15.109 (a)

TESLA

NA 2021-1-14

TESLA.COM/ENERGY

BYLD BETTER

CONTRACTOR

BYLD

ADDRESS: 1213W
MOOREHEAD ST,
NC 28208
LICENSE #:

DESIGNER: OSL

CELIA GENTRY
RESIDENCE

108 WENDYWOOD DR,
ANGIER,
NC 27501

APN: 0681682518.000

DATE: 9/6/2023

DESIGN BY

Complete Solar

A Brighter Way.

SHEET
S-2
SPEC SHEET



Tech Brief

XR Rail Family

Solar Is Not Always Sunny

Over their lifetime, solar panels experience countless extreme weather events. Not just the worst storms in years, but the worst storms in 40 years. High winds capable of ripping panels from a roof, and snowfalls weighing enough to buckle a panel frame.

XR Rails are the structural backbone preventing these results. They resist uplift, protect against buckling and safely and efficiently transfer loads into the building structure. Their superior spanning capability requires fewer roof attachments, reducing the number of roof penetrations and the amount of installation time.

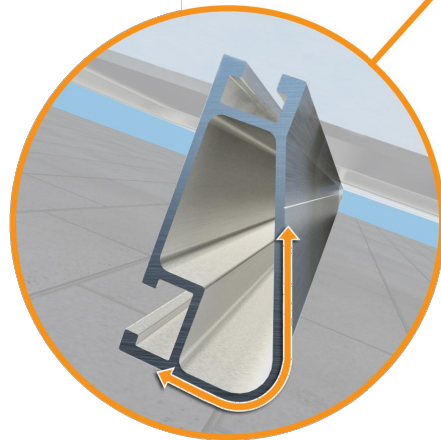
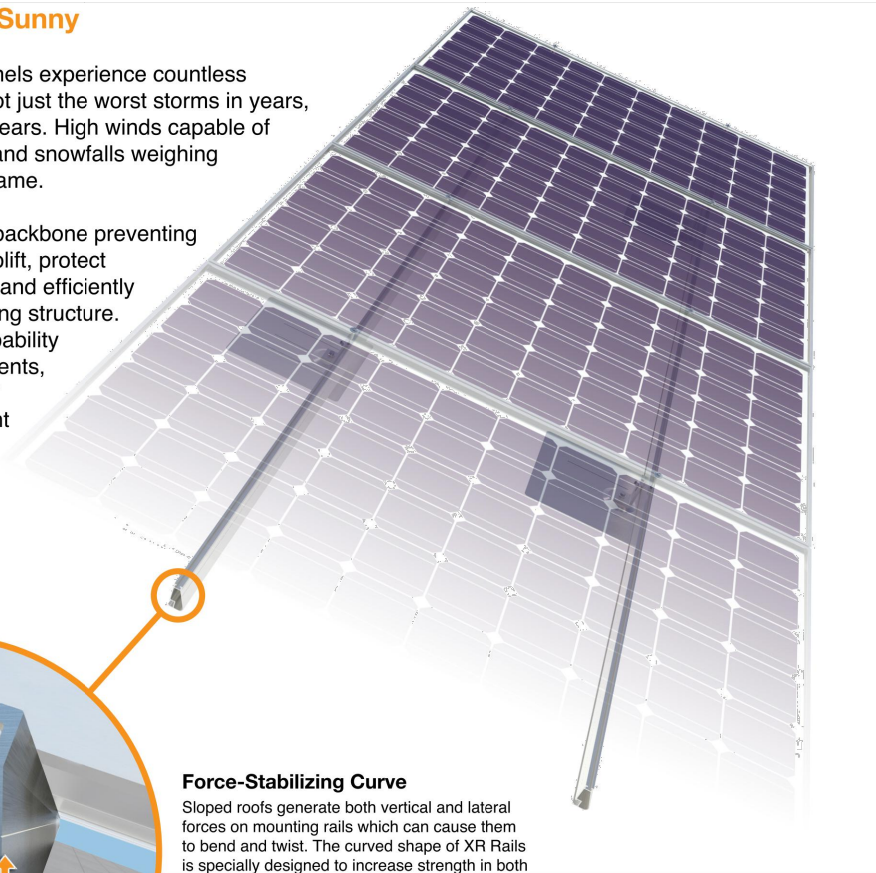

Force-Stabilizing Curve

Sloped roofs generate both vertical and lateral forces on mounting rails which can cause them to bend and twist. The curved shape of XR Rails is specially designed to increase strength in both directions while resisting the twisting. This unique feature ensures greater security during extreme weather and a longer system lifetime.

Compatible with Flat & Pitched Roofs



XR Rails are compatible with FlashFoot and other pitched roof attachments.



IronRidge offers a range of tilt leg options for flat roof mounting applications.

Corrosion-Resistant Materials

All XR Rails are made of 6000-series aluminum alloy, then protected with an anodized finish. Anodizing prevents surface and structural corrosion, while also providing a more attractive appearance.

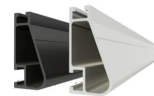

Tech Brief

XR Rail Family

The XR Rail Family offers the strength of a curved rail in three targeted sizes. Each size supports specific design loads, while minimizing material costs. Depending on your location, there is an XR Rail to match.



XR10

XR10 is a sleek, low-profile mounting rail, designed for regions with light or no snow. It achieves spans up to 6 feet, while remaining light and economical.

- 6' spanning capability
- Moderate load capability
- Clear & black anodized finish
- Internal splices available



XR100

XR100 is the ultimate residential mounting rail. It supports a range of wind and snow conditions, while also maximizing spans up to 10 feet.

- 10' spanning capability
- Heavy load capability
- Clear & black anodized finish
- Internal splices available



XR1000

XR1000 is a heavyweight among solar mounting rails. It's built to handle extreme climates and spans up to 12 feet for commercial applications.

- 12' spanning capability
- Extreme load capability
- Clear anodized finish
- Internal splices available

Rail Selection

The table below was prepared in compliance with applicable engineering codes and standards.* Values are based on the following criteria: ASCE 7-16, Gable Roof Flush Mount, Roof Zones 1 & 2e, Exposure B, Roof Slope of 8 to 20 degrees and Mean Building Height of 30 ft. Visit IronRidge.com for detailed certification letters.

Load		Rail Span					
Snow (PSF)	Wind (MPH)	4'	5' 4"	6'	8'	10'	12'
None	90						
	120						
	140	XR10		XR100		XR1000	
	160						
20	90						
	120						
	140						
	160						
30	90						
	160						
40	90						
	160						
80	160						
	160						
120	160						
	160						

*Table is meant to be a simplified span chart for conveying general rail capabilities. Use approved certification letters for actual design guidance.

BYLD BETTER

CONTRACTOR

BYLD

ADDRESS: 1213W
MOOREHEAD ST,
STE 500 CHARLOTTE,
NC 28208
LICENSE #:

DESIGNER: OSL

CELIA GENTRY
RESIDENCE

108 WENDYWOOD DR,
ANGIER,
NC 27501

APN: 0681682518.000

DATE: 9/6/2023

DESIGN BY

Complete Solar

A Brighter Way.

SHEET

S-3

SPEC SHEET

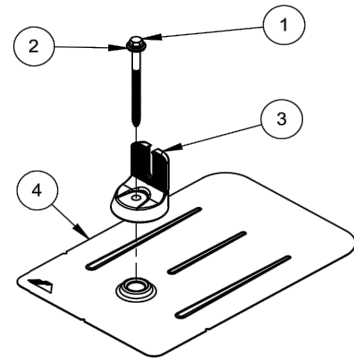

ITEM NO	DESCRIPTION	QTY IN KIT
1	BOLT, LAG 5/16 X 4.25"	1
2	WASHER, EPDM BACKED	1
3	FM FLASHING, MILL OR BLACK	1
4	GRIP CAP, MILL OR BLACK	1

FLASHVUE

PART NUMBER	DESCRIPTION
FV-01-M1	FLASHING, FLASHFOOT, MILL
FV-01-B1	FLASHING, FLASHFOOT, BLACK

1) BOLT, LAG 5/16 x 4.25"

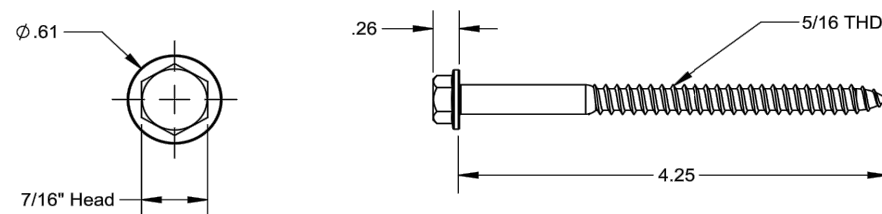

Property	Value
Material	300 Series Stainless Steel
Finish	Clear

v1.0

2) Washer, EPDM Backed

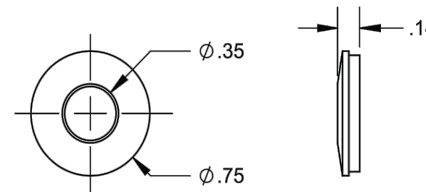

Property	Value
Material	300 Series Stainless Steel
Finish	Clear

3) Grip Cap

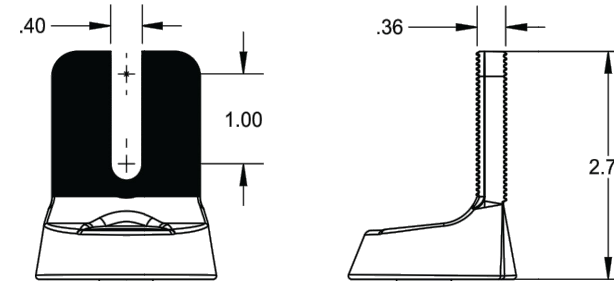

Property	Value
Material	Aluminum
Finish	Mill/Black

4) FM Flashing

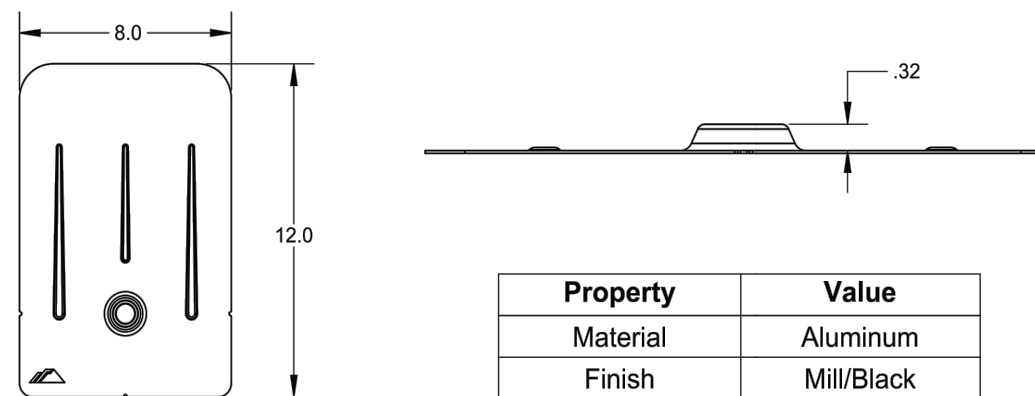

Property	Value
Material	Aluminum
Finish	Mill/Black

v1.0

BYLD BETTER

CONTRACTOR

BYLD

ADDRESS: 1213W
MOOREHEAD ST,
STE 500 CHARLOTTE,
NC 28208
LICENSE #:

DESIGNER: OSL

**CELIA GENTRY
RESIDENCE**

108 WENDYWOOD DR,
ANGIER,
NC 27501

APN: 0681682518.000

DATE: 9/6/2023

DESIGN BY

CompleteSolar

A Brighter Way.

SHEET
S-4
SPEC SHEET