

SCOPE OF WORK

TO INSTALL A SOLAR PHOTOVOLTAIC (PV) SYSTEM AT THE HORNSBY RESIDENCE, LOCATED AT 3195 OLD US 421, LILLINGTON, NORTH CAROLINA. THE POWER GENERATED BY THE PV SYSTEM WILL BE INTERCONNECTED WITH THE UTILITY GRID THROUGH THE EXISTING ELECTRICAL SERVICE EQUIPMENT. THE PV SYSTEM DOES NOT INCLUDE STORAGE BATTERIES.

SYSTEM RATING

8.000 kW DC STC
7.680 kW AC

EQUIPMENT SUMMARY

- (20) (WAAREE WSMD-400) [400W] PV MODULES
- (20) ENPHASE IQ7HS-66-M-US [240V] PV INVERTERS
- (162) (15 X 10.75') LINEAR FEET SUNPOWER INVISIMOUNT

SHEET INDEX

- PV-0 COVER
- PV-1 SITE MAP AND PV LAYOUT
- PV1A RACKING PLAN
- PV-2 STRING MAP AND MONITORING LAYOUT
- PV-3 ELECTRICAL DIAGRAM
- PV-4 EQ WALL & MOUNTING DETAIL
- PV-5 SYSTEM LABELING DETAIL
- PV-6 SITE DIRECTORY PLACARD
- PV-7 SAFETY PLAN

GOVERNING CODES

- 2017 NATIONAL ELECTRICAL CODE
- 2018 NORTH CAROLINA RESIDENTIAL CODE
- 2018 NORTH CAROLINA STATE BUILDING CODE
- UNDERWRITERS LABORATORIES (UL) STANDARDS
- OSHA 29 CFR 1910.269

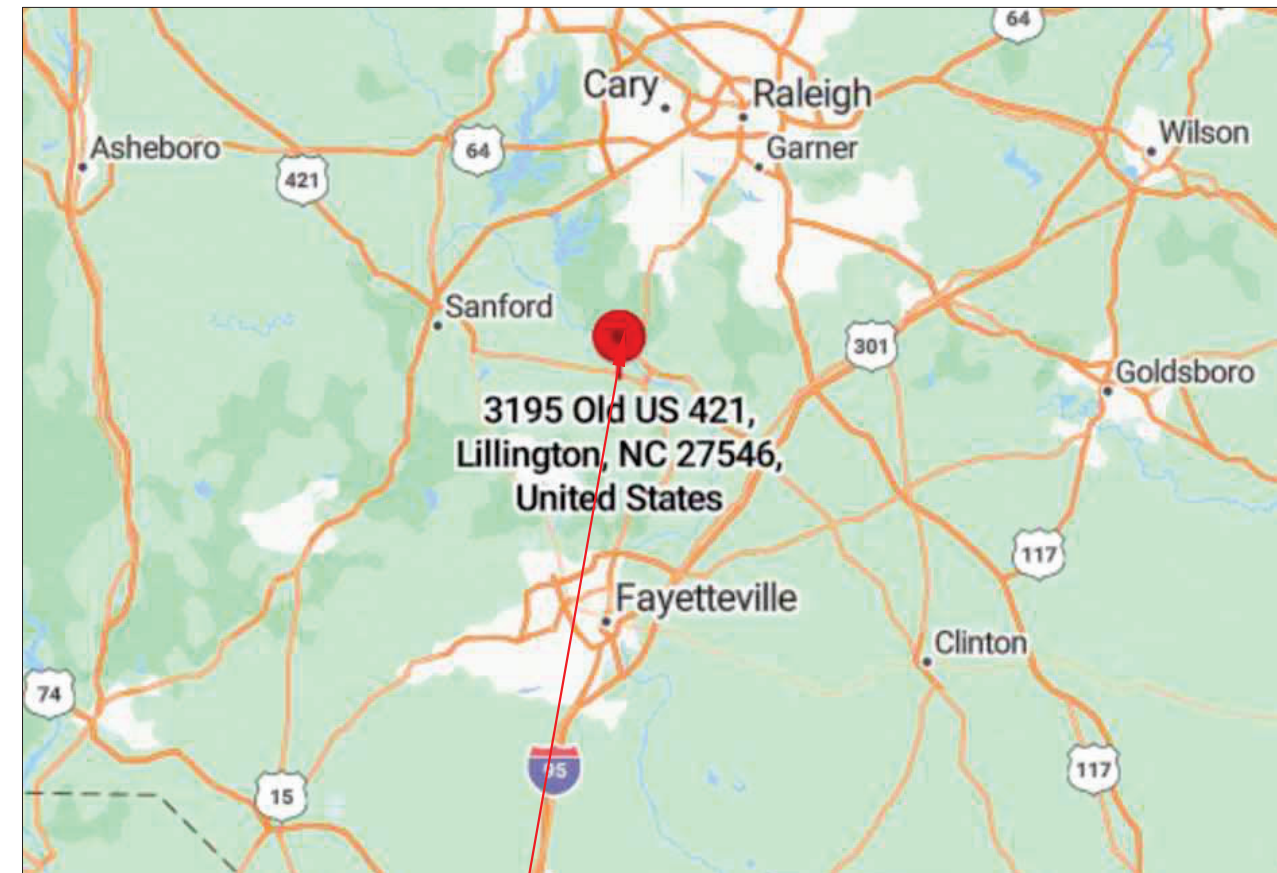

PROJECT LOCATION

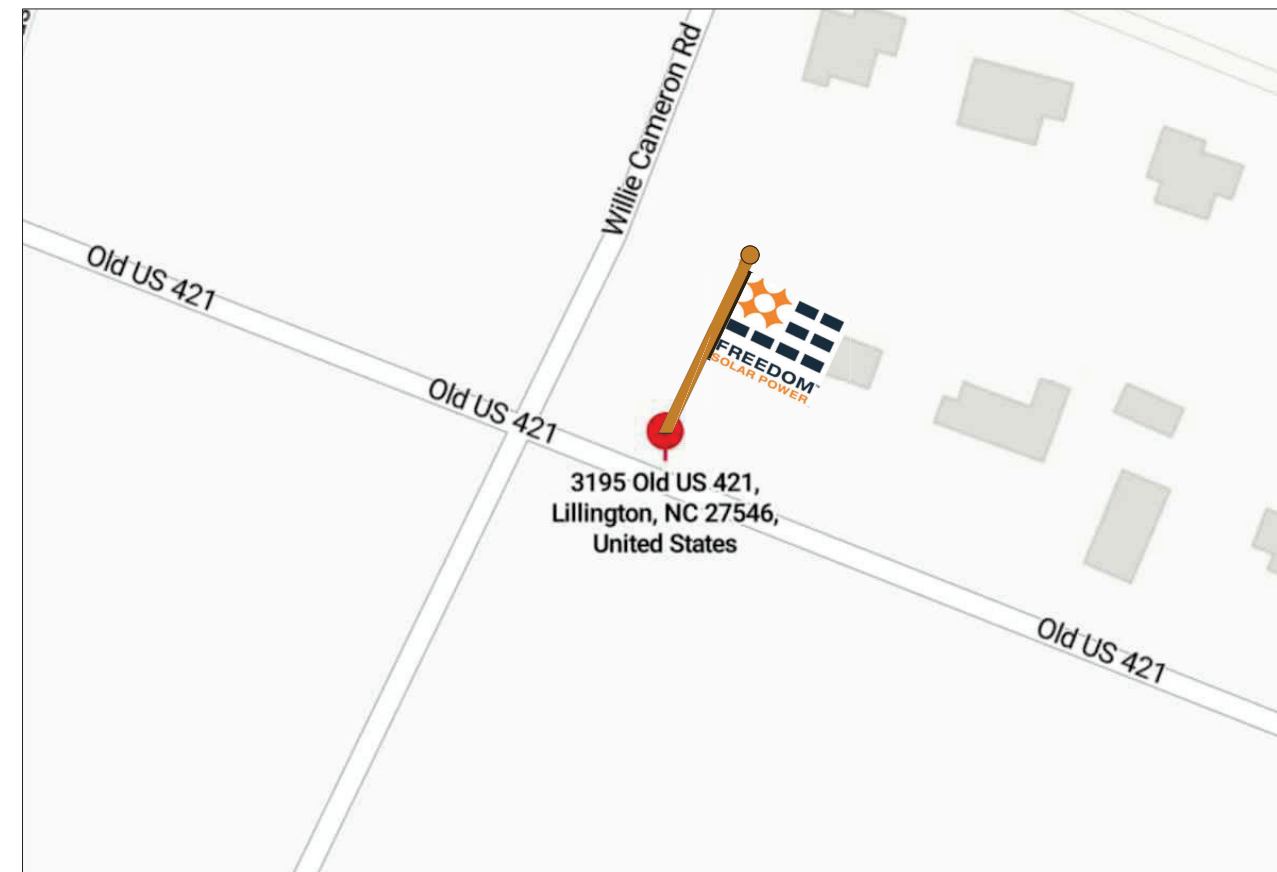

VICINITY MAP

CONTRACTOR



FREEDOM SOLAR LLC
4801 FREIDRICH LN, STE 100
AUSTIN, TX 78744
512-759-8313
TECL # 28621

REVISIONS

DESCRIPTION	DATE	REV
DESIGN PACKET	08/04/2023	

Richard Pantel
PE 043326
NORTH CAROLINA
REGISTERED PROFESSIONAL ENGINEER
RICHARD PANTEL
043326
Date: 2023.08.03 17:58:04 -0500

Reviewed and approved
Richard Pantel, P.E.
NC Lic. No. 043326

PROJECT NAME

DAVID MARK HORNSBY
3195 OLD US 421
LILLINGTON, NORTH CAROLINA,
27546
(910) 890-0868

SHEET NAME

COVER

SHEET SIZE

ANSI B
11" x 17"

SHEET NUMBER

PV-0

LEAD ID: 111195

CONSTRUCTION SUMMARY

- (20) ((WAAREE WSMD-400) [400W]) SOLAR MODULES, 8.000 kW DC STC
MODULE DIMENSIONS = 40.9" X 75.7" X 1.38"
- (20) ENPHASE IQ7HS-66-M-US [240V] PV INVERTERS
COMBINED INVERTER OUTPUT = 7.680 kW AC.
- (162) (15 X 10.75') LINEAR FEET SUNPOWER INVISIMOUNT
- (48) QUICKBOLT QB2 ROOF ATTACHMENTS
- (01) SUNPOWER MONITORING

SITE DETAILS

ROOF TYPE: ASPHALT SHINGLE
 ARRAY #1 - TILT = 33°, AZIMUTH = 279°

NO CUTTING AND COVERING PLUMBING VENTS AT ALL. PVC PIPES CAN BE RELOCATED WITH ROOF JACK IF NEEDED

NOTE: PE STAMPS REQUIRED IF WEIGHT OF ARRAY IS >3PSF, MORE THAN 1-LAYER OF SHINGLE, ROOF TYPE IS OTHER THAN COMP SHINGLES, OR WIND SPEED IS GREATER THAN 140 MPH.

NOTE: PANEL WEIGHT EQUALS 2.5LBS PER SQ FT, LESS THAN 3LBS PER SQ FT.

FALL PROTECTION REQUIRED

CONSTRUCTION NOTES

- 1.) ALL EQUIPMENT SHALL BE INSTALLED IN ACCORDANCE WITH THE MANUFACTURER'S INSTALLATION INSTRUCTIONS.
- 2.) ALL OUTDOOR EQUIPMENT SHALL BE RAINTIGHT WITH MINIMUM NEMA 3R RATING.
- 3.) ALL LOCATIONS ARE APPROXIMATE AND REQUIRE FIELD VERIFICATION.

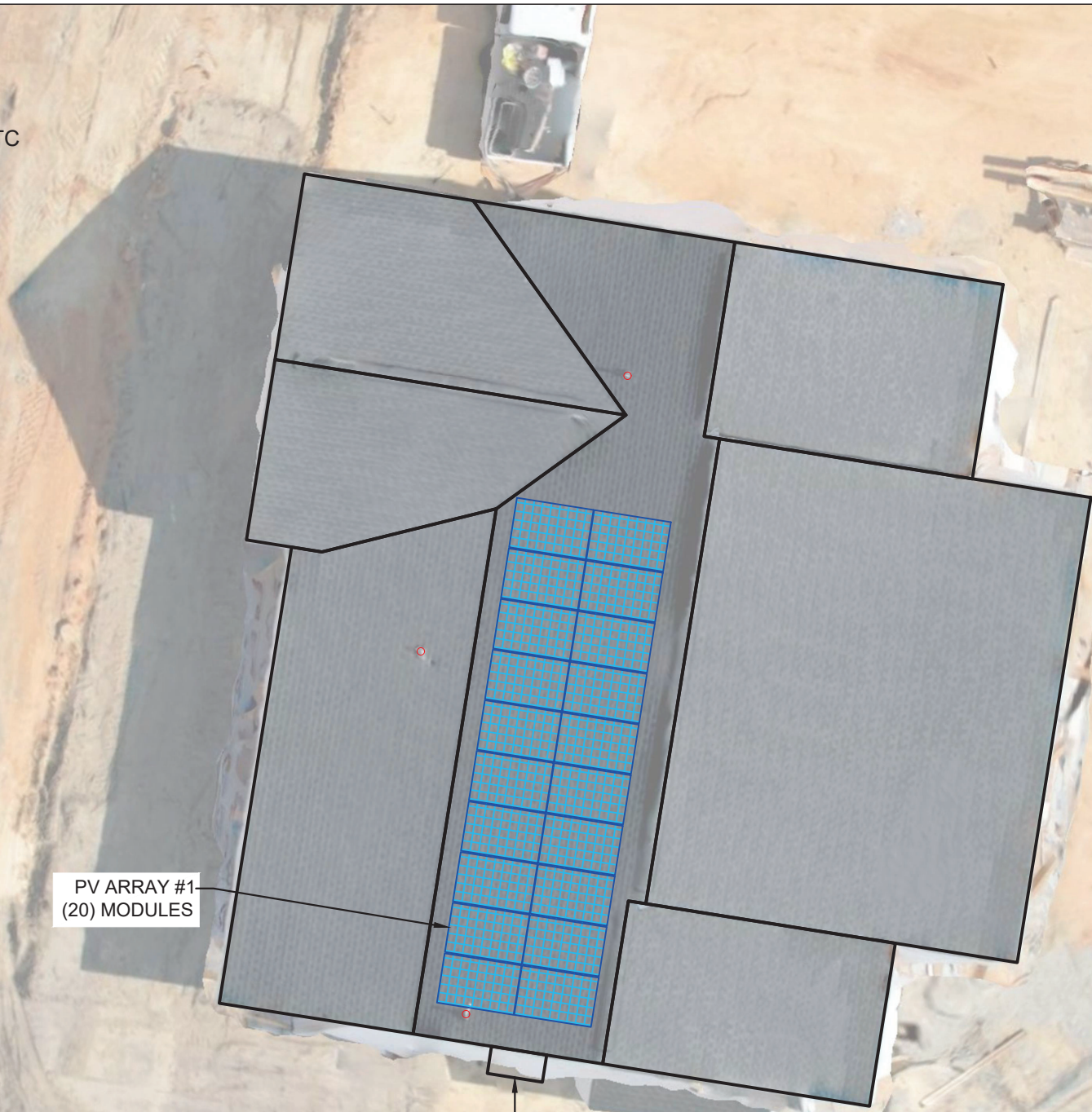

CONTRACTOR

FREEDOM SOLAR POWER
 FREEDOM SOLAR LLC
 4801 FREDRICH LN, STE 100
 AUSTIN, TX 78744
 512-759-8313
 TECL # 28621

REVISIONS

DESCRIPTION	DATE	REV
DESIGN PACKET	08/04/2023	

Reviewed and approved
 Richard Pantel, P.E.
 NC Lic. No. 043326

PROJECT NAME

DAVID MARK HORNSBY
 3195 OLD US 421
 LILLINGTON, NORTH CAROLINA, 27546
 (910) 890-0868

SHEET NAME

SITE MAP & PV LAYOUT

SHEET SIZE

ANSI B
 11" x 17"

SHEET NUMBER

PV-1

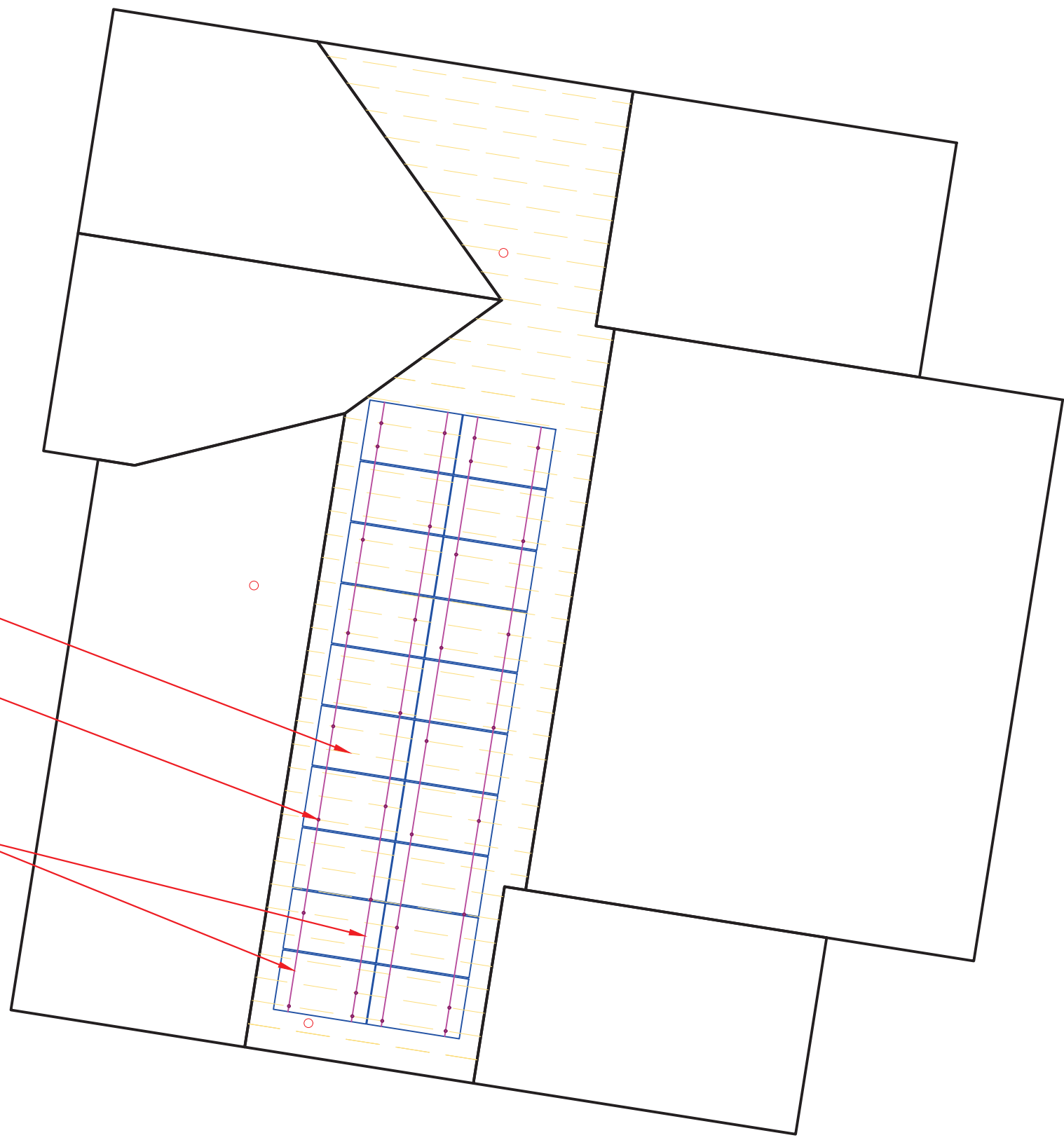

2"X8" RAFTERS 16" O.C. TYP.

5/16" LAG SCREW
W/ MIN. 2.5" EMBEDMENT INTO FRAMING
AT MAX 64" O.C. ALONG RAILS

(2) RAILS PER ROW OF
MODULES EVENLY SPACED

CONSTRUCTION NOTES

- 1.) ALL EQUIPMENT SHALL BE INSTALLED IN ACCORDANCE WITH THE MANUFACTURER'S INSTALLATION INSTRUCTIONS.
- 2.) ALL OUTDOOR EQUIPMENT SHALL BE RAINTIGHT WITH MINIMUM NEMA 3R RATING.
- 3.) ALL LOCATIONS ARE APPROXIMATE AND REQUIRE FIELD VERIFICATION.

CONTRACTOR

FREEDOM SOLAR POWER
 FREEDOM SOLAR LLC
 4801 FREIDRICH LN, STE 100
 AUSTIN, TX 78744
 512-759-8313
 TECL # 28621

REVISIONS

DESCRIPTION	DATE	REV
DESIGN PACKET	08/04/2023	

Reviewed and approved
 Richard Pantel, P.E.
 NC Lic. No. 043326

PROJECT NAME

DAVID MARK HORNSBY
 3195 OLD US 421
 LILLINGTON, NORTH CAROLINA,
 27546
 (910) 890-0868

SHEET NAME

RACKING PLAN

SHEET SIZE

ANSI B
 11" x 17"

SHEET NUMBER

PV-1A

CONTRACTOR



**FREEDOMTM
SOLAR POWER**

FREEDOM SOLAR LLC
4801 FREIDRICH LN. STE 100
AUSTIN, TX 78744
512-759-8313
TECL # 28621

REVISIONS

DESCRIPTION	DATE	REV
DESIGN PACKET	08/04/2023	

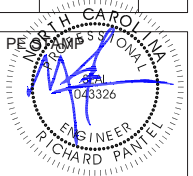

Reviewed and approved
Richard Pantel, P.E.
NC Lic. No. 043326

PROJECT NAME

DAVID MARK HORNSBY
3195 OLD US 421
LILLINGTON, NORTH CAROLINA,
27546
(910) 890-0868

SHEET NAME
**STRING MAP
&
MONITORING
LAYOUT**

SHEET SIZE
**ANSI B
11" x 17"**

SHEET NUMBER
PV-2

SUNPOWER SUPERVISOR S/N _____

SOLAR ARRAY -8.000 kW DC STC, 7.680 kW AC
 (20) (WAAREE WSMD-400) [400W]MODULES
 (20) (ENPHASE IQ7HS-66-M-US[240V]) MICROINVERTERS

NEW JUNCTION BOX:
 TRANSITION FROM DG CABLE
 TO AWG #10 THWN-2
 NEMA 3R, UL LISTED

BRANCH #1



BRANCH #2



(20) (ENPHASE IQ7HS-66-M-US[240V])
 INVERTERS 240VAC, 1.60A MAX
 CEC WEIGHTED EFFICIENCY 97.0%
 NEMA 4R, UL LISTED, INTERNAL GFDI
 MAX CONTINUOUS OUTPUT POWER FOR
 MICROINVERTER EQUAL, 384VA

(1) AWG #6 BARE COPPER
 THWN-2 GND

NEW SOLAR LOAD CENTER
 240VAC, 125A
 NEMA 3R, UL LISTED
 (3) 2P-20A BREAKERS

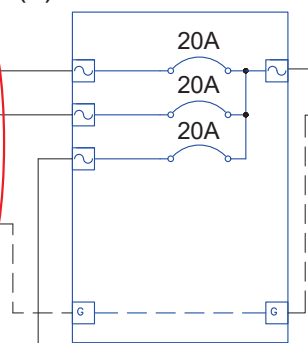

NEW SUNPOWER
 MONITORING

(4) AWG #10 THWN-2
 (1) AWG #10 THWN-2 GND
 IN 3/4" CONDUIT
 OR ROMEX 10/2 IN ATTIC

NEW PV AC DISCONNECT
 240 VAC, 60A
 NON-FUSIBLE,
 NEMA 3R, UL LISTED
 VISIBLE, LOCKABLE, LABELED
 "KNIFE BLADE DISCONNECT"

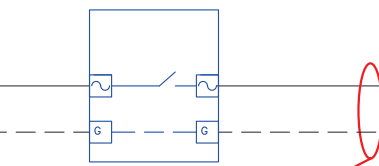

(3) AWG #6 THWN-2
 (1) AWG #8 THWN-2 GND
 IN 1" CONDUIT

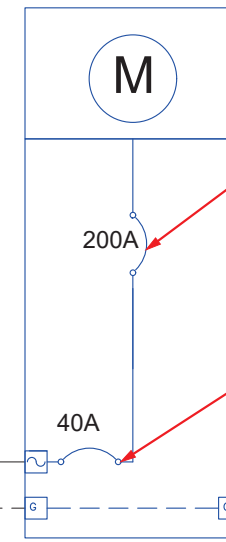

DUKE ENERGY
 REVENUE METER
 #325 374 401
 1- PHASE, 240V

MAIN SERVICE DISCONNECT
 240V, 200A
 METER/MAIN COMBO PANEL
 SQD-HOMELINE, 1P3W
 240V, 200A BUS

POINT OF INTERCONNECTION
 (1) 2P-40A CIRCUIT BREAKER
 INSTALLED AT OPPOSITE END OF
 BUS FROM MAIN DISCONNECT

EXISTING GROUNDING
 ELECTRODE SYSTEM

ELECTRICAL NOTES

- 1.) ALL EQUIPMENT TO BE LISTED BY UL OR OTHER NRTL, AND LABELED FOR ITS APPLICATION.
- 2.) ALL CONDUCTORS SHALL BE COPPER, RATED FOR 600 V AND 90°C WET ENVIRONMENT UNLESS OTHERWISE NOTED.
- 3.) WORKING CLEARANCES AROUND ALL NEW AND EXISTING ELECTRICAL EQUIPMENT SHALL COMPLY WITH NEC 110.26.
- 4.) DRAWINGS INDICATE THE GENERAL ARRANGEMENT OF SYSTEMS. CONTRACTOR SHALL FURNISH ALL NECESSARY OUTLETS, SUPPORTS, FITTINGS AND ACCESSORIES TO FULFILL APPLICABLE CODES AND STANDARDS.
- 5.) WHERE SIZES OF JUNCTION BOXES, RACEWAYS AND CONDUITS ARE NOT SPECIFIED, THE CONTRACTOR SHALL SIZE THEM ACCORDINGLY. SPECIFIED CONDUIT AND WIRE SIZES ARE MINIMUM REQUIREMENTS AND LARGER DIAMETER SHALL BE PERMITTED.
- 6.) ALL WIRE TERMINATIONS SHALL BE APPROPRIATELY LABELED AND READILY VISIBLE.
- 7.) MAXIMUM MOUNTING HEIGHT FROM GRADE TO CENTER OF METER SOCKET SHALL BE 72" FOR RESIDENTIAL SINGLE PHASE METER SOCKETS 0-320 AMPS. MINIMUM MOUNTING HEIGHT IS 30" FROM FOR AUSTIN ENERGY, AND 48" FOR ALL OTHER JURISDICTIONS
- 8.) MINIMUM HORIZONTAL CLEARANCE FROM GAS REGULATOR TO ANY ELECTRICAL ENCLOSURE IS 36", EXCEPT AUSTIN ENERGY WHICH REQUIRES 48" CLEARANCE FROM GAS TO METER SOCKET
- 9.) PV DISCONNECT SHALL BE VISIBLE, LOCKABLE AND LABELED AND THE DOOR CANNOT BE OPENED WHEN HANDLE IS IN ON POSITION
- 10.) BY DEFAULT THE MONITORING DEVICE IS SHOWN CONNECTED TO A 20-AMP BREAKER IN THE SOLAR LOAD CENTER. ALTERNATIVELY, THE MONITORING DEVICE MAY BE CONNECTED TO A 20 AMP BREAKER AT THE MAIN DISTRIBUTION PANEL.
- 11.) ALL EQUIPMENT TERMINATIONS SHALL BE RATED FOR 75 DEGREES OR GREATER
- 12.) ALL CT WIRES SHALL BE CONSIDERED CLASS 1 PER NEC ARTICLE 725, AND BE MARKED AS RATED FOR 600V. PER 725.48(A) CLASS 1 CIRCUITS SHALL BE PERMITTED TO OCCUPY THE SAME RACEWAY AS OTHER CIRCUITS PROVIDED ALL CONDUCTORS ARE INSULATED FOR THE MAXIMUM VOLTAGE OF ANY CONDUCTOR IN THE RACEWAY.
- 13.) AWG #10 COPPER CONDUCTORS ARE SPECIFIED AS THE DEFAULT WIRE REQUIRE FROM THE PV ARRAY TO THE SOLAR LOAD CENTER, HOWEVER, AWG #12 COPPER CONDUCTORS MAY BE UTILIZED IF BOTH OF THE FOLLOWING CONDITIONS ARE MET: THE LENGTH OF THE CONDUCTOR IS LESS THAN 75 FT AND THERE ARE LESS THAN 8 CURRENT-CARRYING CONDUCTORS WITHIN THE RACEWAY.

CALCULATIONS FOR CURRENT CARRYING CONDUCTORS	CALCULATIONS FOR OVERCURRENT DEVICES
<p>INVERTER OUTPUT WIRE AMPACITY CALCULATION [NEC 690.8(A)(3)]: 1.60A PER INVERTER (ENPHASE IQ7HS-66-M-US [240V]) MAXIMUM INVERTER BRANCH CURRENT = (10)(1.60A) = 16.0A CONTINUOUS USE: #10 WIRE 75°C DERATED AMPACITY = (0.80)(35.0A) = 28.0A 28.0A > 16.0A</p> <p>CONDITIONS OF USE: #10 WIRE 90°C DERATED AMPACITY = (0.91)(0.80)(40.0A) = 29.1A 29.1A > 16.0A</p> <p>SOLAR LOAD CENTER OUTPUT WIRE AMPACITY CALCULATION [NEC 690.8(A)(3)]: 1.60A PER INVERTER (ENPHASE IQ7HS-66-M-US [240V]) COMBINED CURRENT = (20)(1.60A) = 32.0A CONTINUOUS USE: #6 WIRE 75°C DERATED AMPACITY = (0.80)(65A) = 52.0A 52.0A > 32.0A</p> <p>CONDITIONS OF USE: #6 WIRE 90°C DERATED AMPACITY = (0.91)(75A) = 68.3A 68.3A > 32.0A</p>	<p>INVERTER BRANCH AC CURRENT CALCULATION [NEC 690.8(A)(3)]: 1.60A PER INVERTER (ENPHASE IQ7HS-66-M-US [240V]) MAXIMUM BRANCH INVERTER CURRENT = (10)(1.60A) = 16.0A MINIMUM OCPD = (16.0A)(1.25) = 20.0A USE 2P-20A BREAKERS IN SOLAR LOAD CENTER FOR INVERTER BRANCH OCPD</p> <p>SYSTEM AC CURRENT CALCULATION [NEC 690.8(A)(3)]: 1.60A PER INVERTER (ENPHASE IQ7HS-66-M-US [240V]) COMBINED CURRENT = (20)(1.60A) = 32.0A MINIMUM OCPD = (32.0A)(1.25A) = 40.0A USE 2P-40A BREAKER IN MDP FOR SYSTEM OCPD</p>

CONTRACTOR

FREEDOM
SOLAR POWER

FREEDOM SOLAR LLC
 4801 FREIDRICH LN, STE 100
 AUSTIN, TX 78744
 512-759-8313
 TECL # 28621

REVISIONS		
DESCRIPTION	DATE	REV
DESIGN PACKET	08/04/2023	

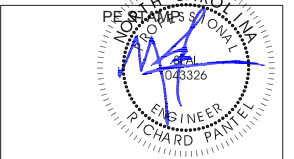

Reviewed and approved
 Richard Pantel, P.E.
 NC Lic. No. 043326

PROJECT NAME

DAVID MARK HORNSBY
 3195 OLD US 421
 LILLINGTON, NORTH CAROLINA,
 27546
 (910) 890-0868

SHEET NAME

**ELECTRICAL
 DIAGRAM**

SHEET SIZE

**ANSI B
 11" x 17"**

SHEET NUMBER

PV-3

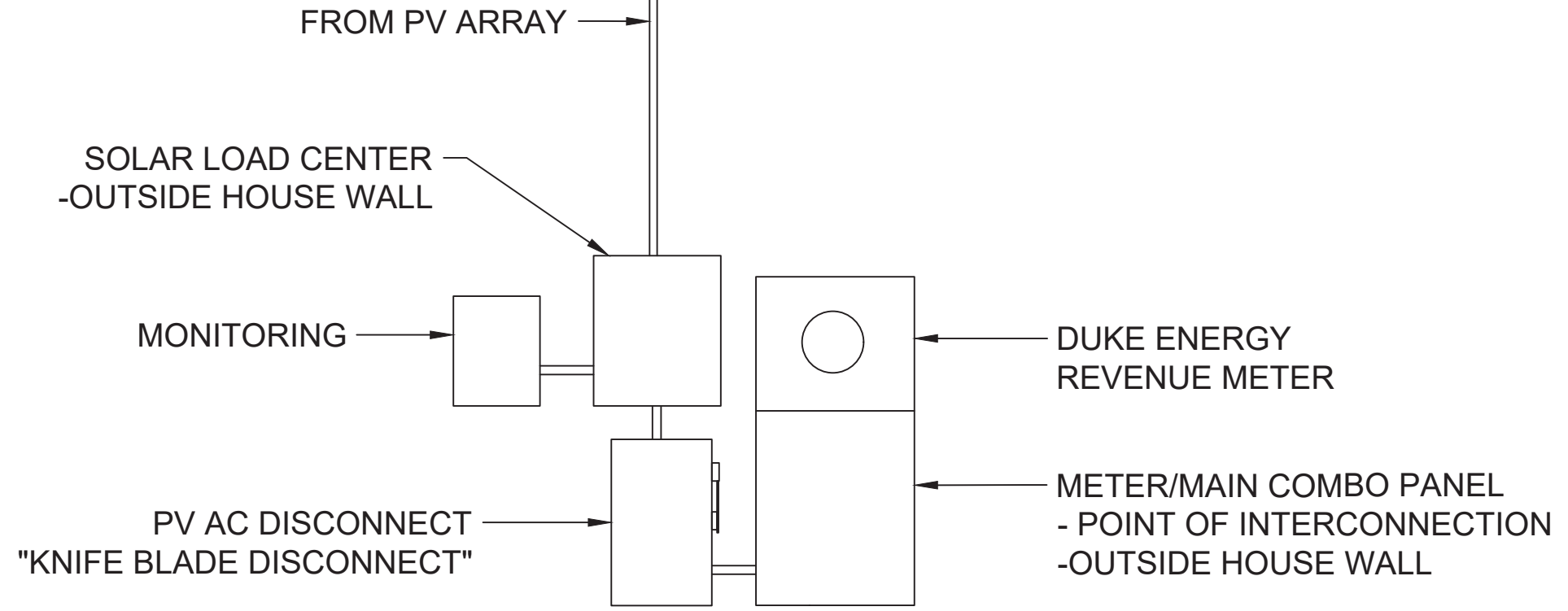

CONTRACTOR



**FREEDOM[™]
SOLAR POWER**

FREEDOM SOLAR LLC
4801 FREIDRICH LN. STE 100
AUSTIN, TX 78744
512-759-8313
TECL # 28621

REVISIONS

DESCRIPTION	DATE	REV
DESIGN PACKET	08/04/2023	

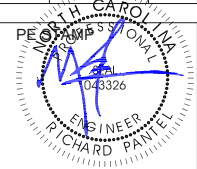

Reviewed and approved
Richard Pantel, P.E.
NC Lic. No. 043326

PROJECT NAME

DAVID MARK HORNSBY
3195 OLD US 421
LILLINGTON, NORTH CAROLINA,
27546
(910) 890-0868

EQUIPMENT ELEVATION
NTS 1

SEE (3/PV4 - EQ
WALL) FOR
ENLARGED
VIEW

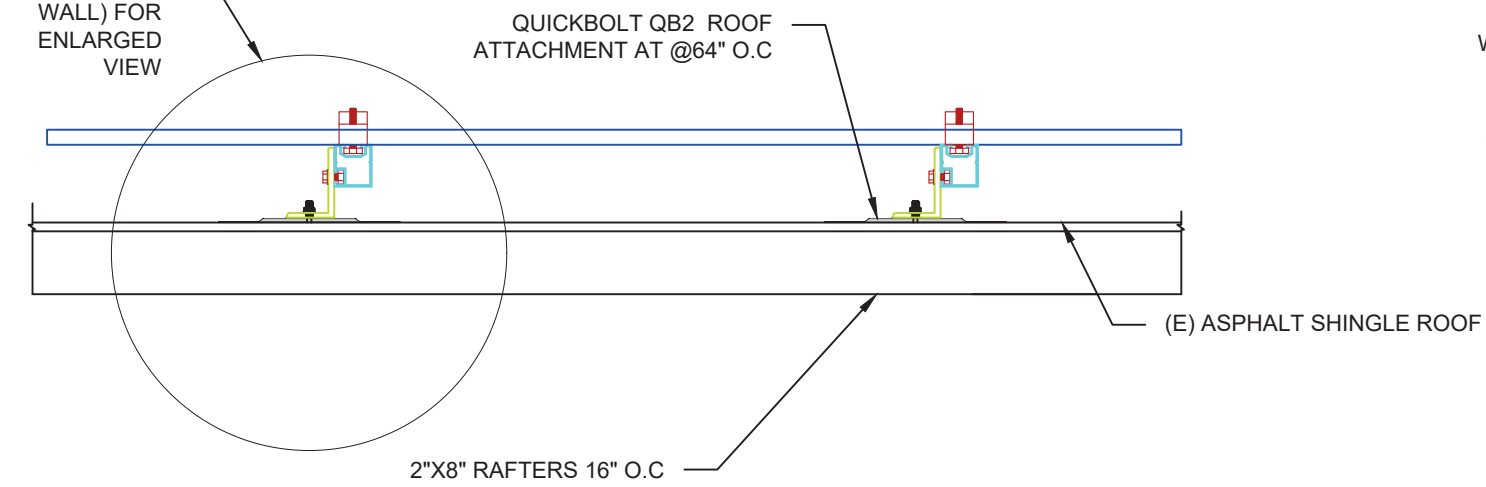

MOUNTING METHOD
NTS 2

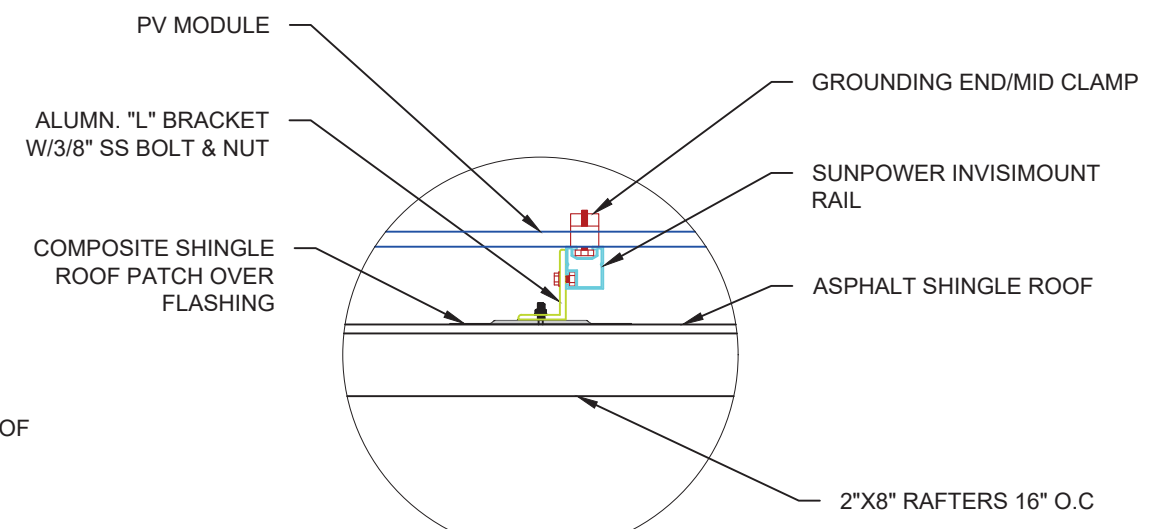

MOUNTING DETAIL
NTS 3

SHEET NAME
**EQ.WALL &
MOUNTING DETAIL**

SHEET SIZE
**ANSI B
11" x 17"**

SHEET NUMBER
PV-4

NOTE: NOT ALL LABELS MAY BE APPLICABLE

SIGNAGE REQUIREMENTS

- > RED BACKGROUND
- > WHITE LETTERING
- > MIN. 3/8" LETTER HEIGHT
- > ALL CAPITAL LETTERS
- > ARIAL OR SIMILAR FONT
- > REFLECTIVE, WEATHER RESISTANT MATERIAL, UL 969

CONTRACTOR



**FREEDOM[™]
SOLAR POWER**

FREEDOM SOLAR LLC
4801 FREIDRICH LN, STE 100
AUSTIN, TX 78744
512-759-8313
TECL # 28621

REVISIONS

DESCRIPTION	DATE	REV
DESIGN PACKET	08/04/2023	



Reviewed and approved
Richard Pantel, P.E.
NC Lic. No. 043326

PROJECT NAME

DAVID MARK HORNSBY
3195 OLD US 421
LILLINGTON, NORTH CAROLINA,
27546
(910) 890-0868

SHEET NAME

SYSTEM LABELING
DETAIL

SHEET SIZE

ANSI B
11" x 17"

SHEET NUMBER

PV-5

PV SYSTEM DISCONNECT

REQ'D BY: NEC 690.13(B)
APPLY TO:
PV DISCONNECT

A

WARNING
ELECTRIC SHOCK HAZARD.
DO NOT TOUCH TERMINALS.
TERMINALS ON THE LINE AND
LOAD SIDES MAY BE
ENERGIZED IN THE OPEN
POSITION.

REQ'D BY: NEC 690.13(B)
APPLY TO:
PV DISCONNECT

B

**WARNING: PHOTOVOLTAIC
POWER SOURCE**

REQ'D BY: NEC 690.31(G)(3)
APPLY TO:
RACEWAYS, CABLE TRAYS,
OTHER WIRING METHODS, AND
ENCLOSURES THAN CONTAIN
PV SYSTEM DC CONDUCTORS

C

WARNING
POWER SOURCE OUTPUT
CONNECTION. DO NOT
RELOCATE THIS
OVERCURRENT DEVICE

REQ'D BY: NEC 705.12(B)(2)(3)(b)
APPLY TO:
DISTRIBUTION EQUIPMENT
ADJACENT TO BACK-FED BREAKER

D

2" ADDRESS NUMBERS

REQ' BY: AHJ
APPLY TO:
REVENUE METER SOCKET
(IF APPLICABLE)

E

REVENUE METER

REQ'D BY: AHJ
APPLY TO:
REVENUE METER SOCKET
(IF APPLICABLE)

F

MONITORING

REQ'D BY: FREEDOM SOLAR
APPLY TO:
MONITORING DEVICE ENCLOSURE

G

**RAPID SHUTDOWN SWITCH FOR
SOLAR PV SYSTEM**

REQ' BY: NEC 690.56(C)(2)
APPLY TO:
PV DISCONNECT

H

**PHOTOVOLTAIC SYSTEM
AC DISCONNECT**
OPERATING CURRENT: 32.0 A
OPERATING VOLTAGE: 240 VAC

REQ'D BY: 690.56(1)(a)
APPLY TO:
PV DISCONNECT

I

**SOLAR PV SYSTEM EQUIPPED
WITH RAPID SHUTDOWN**

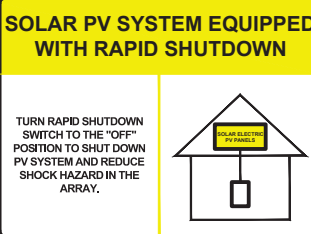

REQ'D BY: NEC 690.56(C)(1)(a)
UTILITY AC DISCONNECT

J

CAUTION

POWER TO THIS BUILDING IS ALSO SUPPLIED FROM THE FOLLOWING SOURCES WITH DISCONNECTS AS SHOWN:

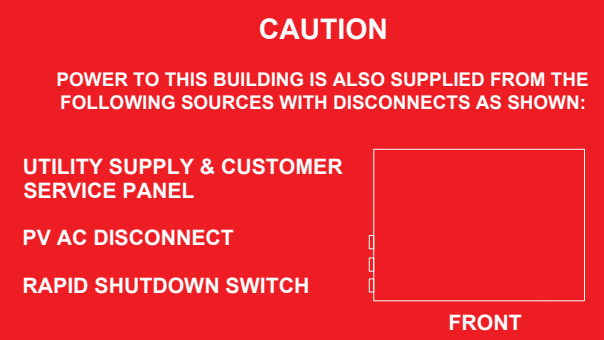

UTILITY SUPPLY & CUSTOMER SERVICE PANEL

PV AC DISCONNECT

RAPID SHUTDOWN SWITCH

FRONT

REQ'D BY: 705.10
APPLY TO:
MAIN DISTRIBUTION PANEL
(*ONLY REQUIRED IF PV SYSTEM DISCONNECT IS NOT GROUPED WITH MAIN SERVICE DISCONNECT)
SEE SHEET PV-6 FOR SITE SPECIFIC LABELS

K

CAUTION:
MULTIPLE SOURCES OF POWER
LOCATION OF EACH POWER SOURCE
DISCONNECTING MEANS SHOWN BELOW

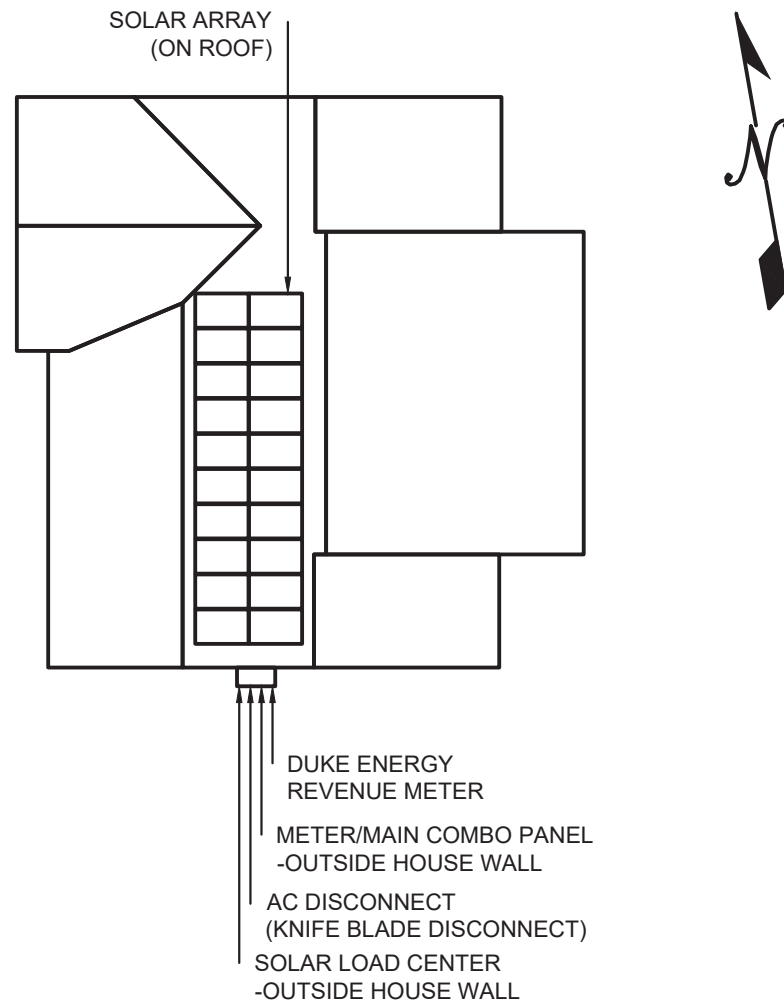

QUESTIONS, CALL:
 800-504-2337
www.freedomsolarpower.com

FREEDOM
SOLAR POWER
 3195 OLD US 421
 PROJECT ID: 111195

CONTRACTOR

FREEDOM™
SOLAR POWER

FREEDOM SOLAR LLC
 4801 FREDRICH LN, STE 100
 AUSTIN, TX 78744
 512-759-8313
 TECL # 28621

REVISIONS

DESCRIPTION	DATE	REV
DESIGN PACKET	08/04/2023	

Reviewed and approved
 Richard Pantel, P.E.
 NC Lic. No. 043326

PROJECT NAME

DAVID MARK HORNSBY
 3195 OLD US 421
 LILLINGTON, NORTH CAROLINA,
 27546
 (910) 890-0868

SHEET NAME

SITE
 DIRECTORY
 PLACARD

SHEET SIZE

ANSI B
 11" x 17"

SHEET NUMBER

PV-6

USE THE SAFETY SYMBOL KEY TO DRAW IN THE CONTROLLED ACCESS ZONE (CAZ), LADDER PLACEMENT, METER LOCATION, FALL PROTECTION ANCHOR POINT, AND ANY OTHER HAZARD.

HARD HAT IS REQUIRED AT ALL TIMES IN CAZ

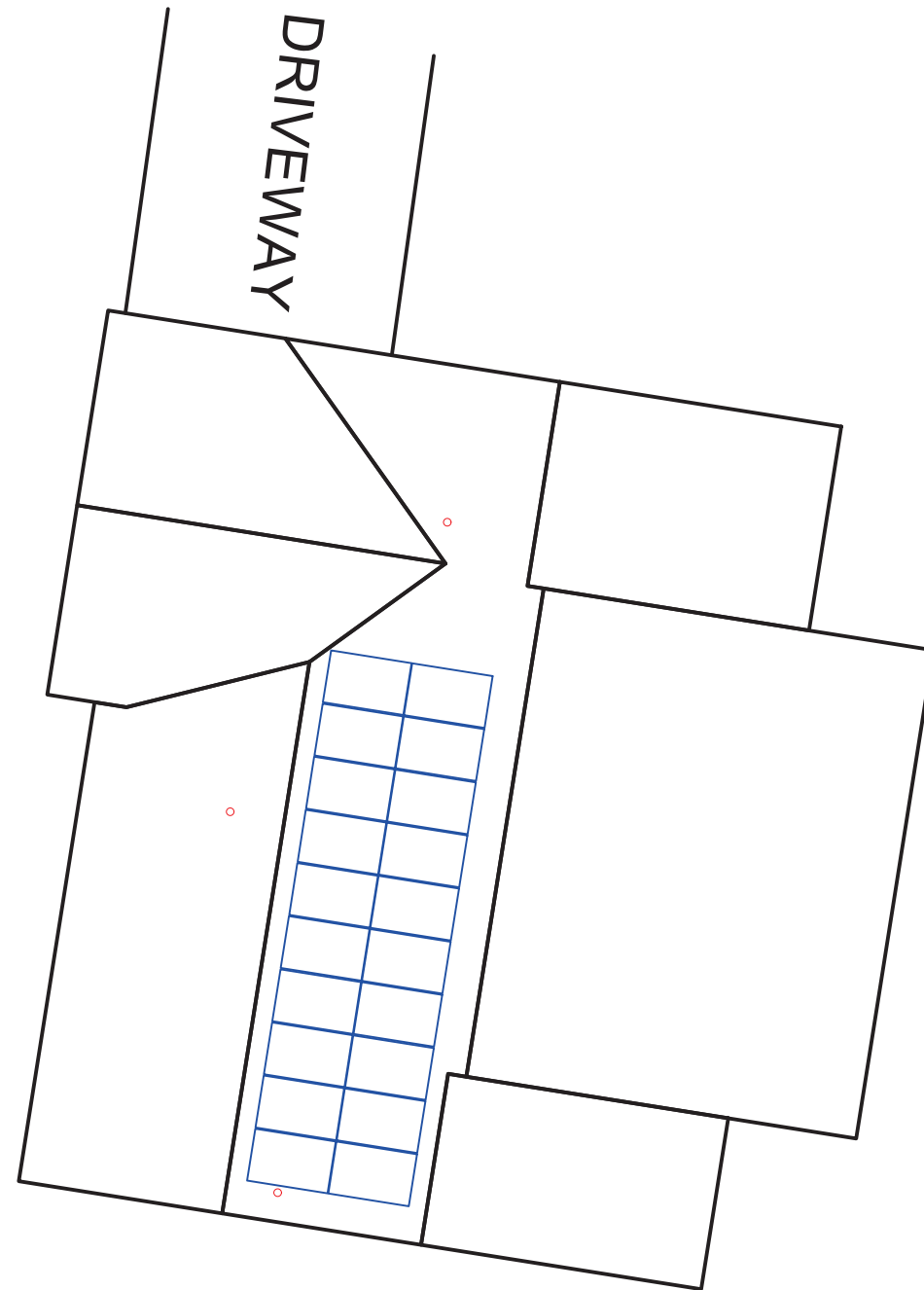

SAFETY SYMBOL KEY

- CAZ
- L** LADDER
- M** METER
- ==== POWER LINES
- R** RESTRAINT ANCHOR
- A** ARREST ANCHOR



CONTRACTOR

FREEDOM SOLAR POWER
 FREEDOM SOLAR LLC
 4801 FREIDRICH LN, STE 100
 AUSTIN, TX 78744
 512-759-8313
 TECL # 28621

REVISIONS		
DESCRIPTION	DATE	REV
DESIGN PACKET	08/04/2023	

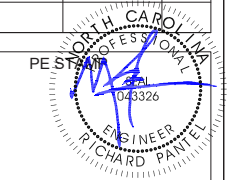

Reviewed and approved
 Richard Pantel, P.E.
 NC Lic. No. 043326

PROJECT NAME

DAVID MARK HORNSBY
 3195 OLD US 421
 LILLINGTON, NORTH CAROLINA, 27546
 (910) 890-0868

SHEET NAME

SAFETY PLAN

SHEET SIZE

ANSI B
 11" x 17"

SHEET NUMBER

PV-7

CONDUCT SAFETY MEETING WITH ALL CREW MEMBERS ON SITE AT THE BEGINNING OF EACH JOB. USE SIGN IN SHEET BELOW.

1. _____
2. _____
3. _____
4. _____
5. _____

GUEST SIGN IN

1. _____
2. _____
3. _____

COMPETENT PERSON: _____ JOB START DATE: _____

ARKA SERIES

WSMDi-395 to WSMDi-415



One with the Sun



One with the Sun



Highest reliability & enhanced crack tolerant 9BB module



Better performance under all climatic conditions



Split junction box



Reduced power losses up to 1/4 times



PID resistant with long term reliability



Sustain heavy wind & snow loads (2400 pa & 5400 pa)

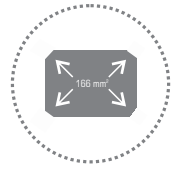

M6 Mono PERC cells

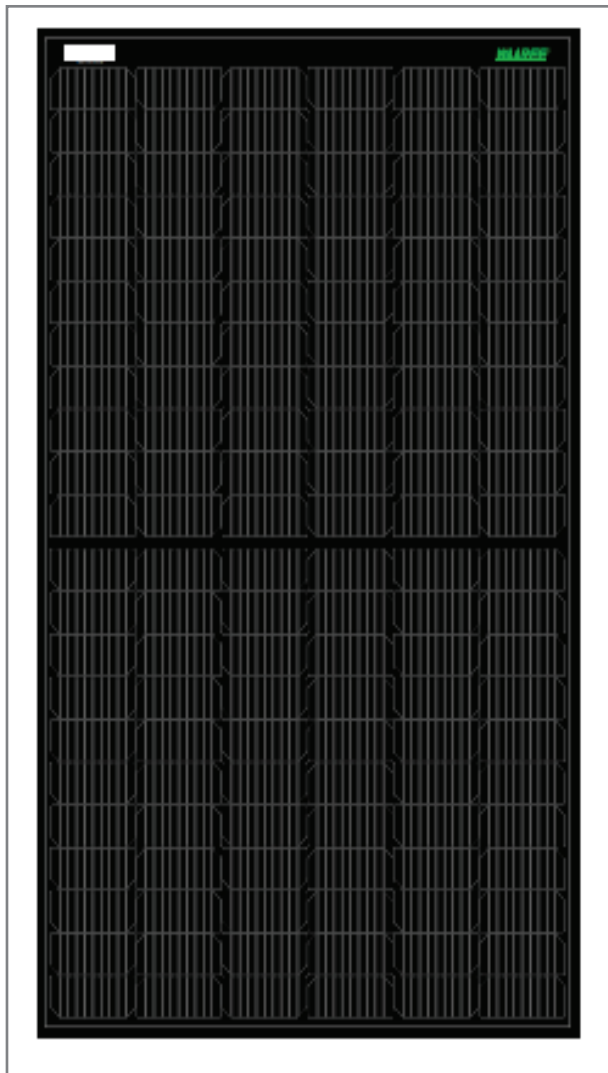

I-V VARIATION WITH IRRADIANCE

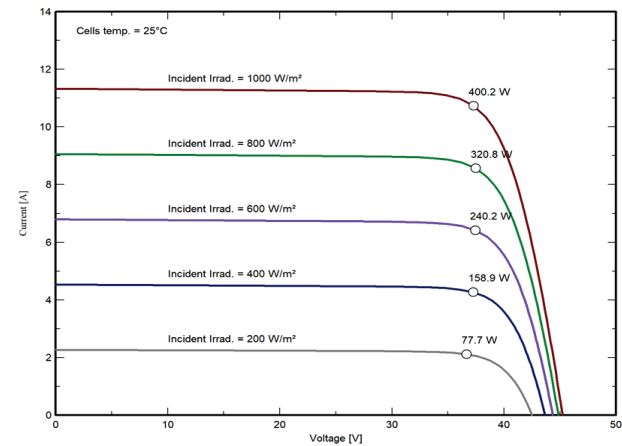

I-V VARIATION WITH TEMPERATURE

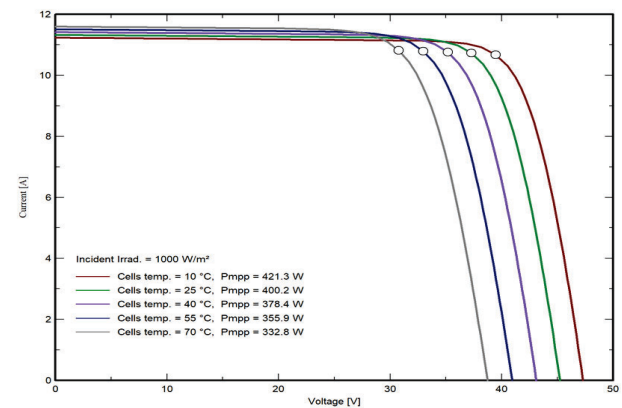

The Graphs are for reference purpose only. Please consult Waaree technical team for further clarifications.

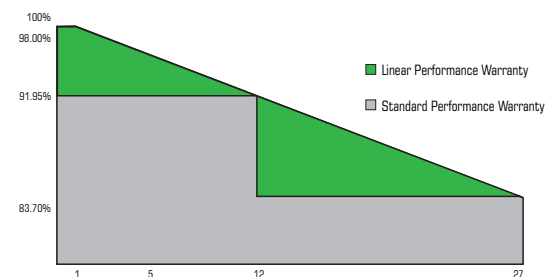

INTERNATIONAL & NATIONAL CERTIFICATIONS

IEC 61215 | IEC 61730 | UL61730
IEC TS 62804-1



ISO 9001:2015 | ISO 14001:2015 | ISO 45001:2018
Independent assessment of factories by BLACK & VEATCH

ARKA SERIES

WSMDi-395 to WSMDi-415

ELECTRICAL CHARACTERISTICS

Models	Pmax (W)		Vmp (V)		Imp (A)		Isc (A)		Voc (V)		Module Eff. (%)
	STC	NOCT	STC	NOCT	STC	NOCT	STC	NOCT	STC	NOCT	
WSMD-395	395	296.8	37.77	34.70	10.47	8.55	11.24	9.08	45.00	42.10	19.78
WSMD-400	400	300.6	38.00	34.90	10.54	8.62	11.32	9.14	45.22	42.30	20.03
WSMD-405	405	304.4	38.22	35.10	10.61	8.68	11.40	9.21	45.44	42.50	20.28
WSMD-410	410	308.2	38.44	35.30	10.68	8.74	11.48	9.27	45.66	42.70	20.53
WSMD-415	415	312.1	38.66	35.40	10.75	8.81	11.57	9.34	45.88	42.90	20.78

*Standard Test Conditions (STC) - 1000 W/m2 irradiance, Air Mass 1.5 and 25°C cell temperature. Nominal Operating Cell Temperature (NOCT) - 800 W/m2 irradiance, Air Mass 1.5, Ambient temperature 20°C and Wind speed 1 m/s. Average power reduction of 4.5% at 200 W/m2 as per IEC 60904-1. Measuring Uncertainty ± 3%.

System Voltage	1500 V	Series Fuse Rating	22 A
----------------	--------	--------------------	------

MECHANICAL CHARACTERISTICS

Length x Width x Thickness (L x W x T)	1924 mm (L) x 1038 mm (W) x 35 mm (T)
Weight	22 kgs
Solar Cells per Module (Units) / Arrangement	132 cells / (11x6 11x6)
Solar Cell Type & Size	Mono PERC, 83 x 166 mm
Front Glass	3.2 mm Low Iron and Tempered glass with AR coating
Encapsulate	PID Free & UV Resistant
Junction Box (Protection degree/ Material)	IP68 / Weatherproof PPO
Cable & Connector (Protection degree / Type)	IP68 rated / Staubli MC4 Connector
Cable cross - section & Length	4 mm² & 1200mm
Frame	Anodized Aluminium Alloy, Anodization thickness ≥ 15 micron

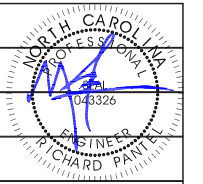

Reviewed and approved
Richard Pantel, P.E.
NC Lic. No. 043326

DESIGN SPECIFICATIONS

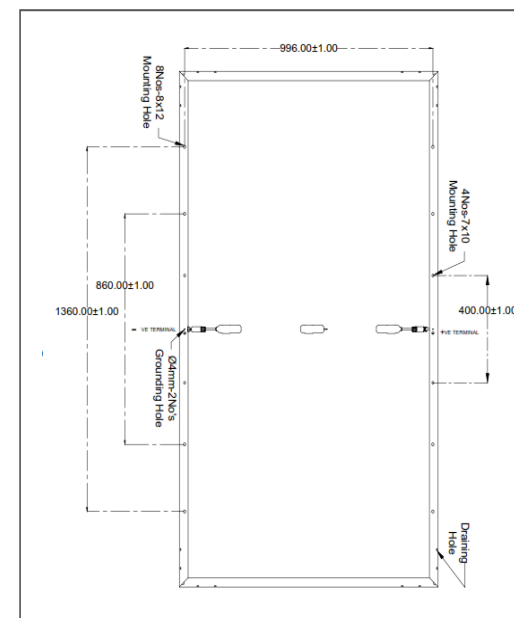

THERMAL CHARACTERISTICS

Temperature coefficient of Current (Isc), α (%/°C)	0.055
Temperature coefficient of Voltage (Voc), β (%/°C)	-0.285
Temperature coefficient of Power (Pm), γ (%/°C)	-0.365
NOCT (°C)	43 ± 2
Operating temperature range (°C)	-40 to 8

Waaree Energies Ltd. is amongst the top Solar Energy Companies and has the country's largest Solar PV Module manufacturing capacity of 5 GW. In addition, it is committed to provide top notch EPC services, project development, rooftop solutions, solar water pumps and also in an Independent Power Producer. Waaree has its presence in over 325+ locations nationally and 68 countries globally.

*If you need specific product certificates, and if module installations are to deviate from our guidance specified in our installation manual, please contact your local Waaree sales and technical representatives.

12 Years Product Warranty • 27 Years Power Output Warranty

- The electrical data given here is for reference purpose only.
- Please confirm your exact requirements with the sales representative while placing your order.
- Refer installation Manual instructions & Waaree warranty statement for terms & conditions.
- Waaree Reserves the right to change the specifications without prior notice.z

Enphase IQ7HS Microinverter

The high-powered smart grid-ready **Enphase IQ7HS Microinverter™** with integrated MC4 connectors dramatically simplify the installation process while achieving the highest system efficiency.

The IQ Series Microinverters extend the reliability standards set forth by previous generations and undergo over a million hours of power-on testing, enabling Enphase to provide an industry-leading warranty of up to 25 years.



Easy to Install

- Lightweight and simple
- Faster installation with improved, lighter two-wire cabling
- Built-in rapid shutdown compliant (NEC 2014, 2017 & 2020)

Efficient and Reliable

- Optimized for high powered 66-cell* modules
- Highest CEC efficiency of 97.0%
- More than a million hours of testing
- Class II double-insulated enclosure
- UL listed

Smart Grid Ready

- Complies with advanced grid support, voltage and frequency ride-through requirements
- Remotely updates to respond to changing grid requirements
- Configurable for varying grid profiles
- Meets CA Rule 21 (UL 1741-SA)

* The IQ7HS is required to support 66-cell modules.

Enphase IQ7HS Microinverter

INPUT DATA (DC)	IQ7HS-66-M-US	
Commonly used module pairings ¹	320 W - 460 W +	
Module compatibility	66-cell PV modules	
Maximum input DC voltage	59 V	
Peak power tracking voltage	38 V - 43 V	
Operating range	20 V - 59 V	
Min/Max start voltage	30 V / 59 V	
Max DC short circuit current (module Isc)	15 A	
Overvoltage class DC port	II	
DC port backfeed current	0 A	
PV array configuration	1 x 1 ungrounded array; No additional DC side protection required; AC side protection requires max 20A per branch circuit	

OUTPUT DATA (AC)	@240 VAC	@208 VAC
Peak output power	384 VA	369 VA
Maximum continuous output power	384 VA	369 VA
Nominal (L-L) voltage/range ²	240 V / 211-264 V	208 V / 183-229 V
Maximum continuous output current	1.60 A (240V)	1.77 A (208V)
Nominal frequency	60 Hz	60 Hz
Extended frequency range	47 to 68 Hz	47 to 68 Hz
AC short circuit fault current over 3 cycles	4.82 A	4.82 A
Maximum units per 20 A (L-L) branch circuit ³	10	9
Overvoltage class AC port	III	III
AC port backfeed current	18 mA	18 mA
Power factor setting	1.0	1.0
Power factor (adjustable)	0.85 leading ...0.85 lagging	0.85 leading ...0.85 lagging

EFFICIENCY	@240 V	@208 V
CEC weighted efficiency	97.0 %	96.5 %

MECHANICAL DATA	
Ambient temperature range	-40°C to +60°C
Relative humidity range	4% to 100% (condensing)
Connector type	Staubli made MC4
Dimensions (WxHxD)	212 mm x 175 mm x 30.2 mm (without bracket)
Weight	1.08 kg (2.38 lbs)
Cooling	Natural convection - No fans
Approved for wet locations	Yes
Pollution degree	PD3
Enclosure	Class II, corrosion resistant polymeric enclosure
Environmental category / UV exposure rating	NEMA type 6 / outdoor
Altitude	2000m

FEATURES	
Communication	Power Line Communication (PLC)
Disconnecting means	The AC and DC connectors have been evaluated and approved by UL for use as the load-break disconnect means required by NEC 690 and C22.1-2018 Rule 64-220.
Compliance	CA Rule 21 (UL 1741-SA), HECO v1.1 UL 62109-1, UL1741/IEEE1547, FCC Part 15 Class B, ICES-0003 Class B, CAN/CSA-C22.2 NO. 107.1-01 This product is UL Listed as PV Rapid Shut Down Equipment and conforms with NEC-2014, NEC-2017 section 690.12, NEC 2020 and C22.1-2015 Rule 64-218 Rapid Shutdown of PV Systems, for AC and DC conductors, when installed according to manufacturer's instructions.

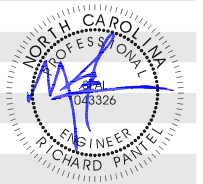

Reviewed and approved
 Richard Pantel, P.E.
 NC Lic. No. 043326

1. No enforced DC/AC ratio. See the compatibility calculator at <https://enphase.com/en-us/support/module-compatibility>.
 2. Nominal voltage range can be extended beyond nominal if required by the utility.
 3. Limits may vary. Refer to local requirements to define the number of microinverters per branch in your area.

To learn more about Enphase offerings, visit enphase.com





SunPower® EnergyLink™ | Residential and Commercial PVS6

Improve Support, Reduce Maintenance Costs

An intuitive monitoring website enables you to:

- See a visual map of customer sites
- Remotely manage hundreds of sites
- Receive elective system reports
- Locate system issues and remotely diagnose
- Diagnose issues online
- Drill down for the status of individual devices

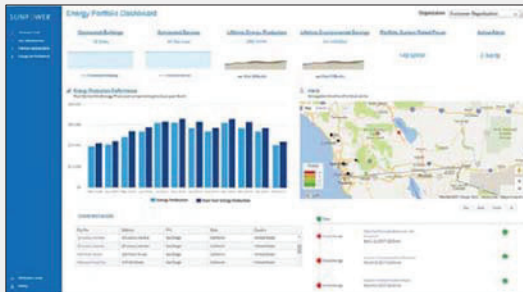

Add Value for Customers

With the SunPower Monitoring System customers can:

- See what their solar system produces each day, month, or year
- Optimize their solar investment and save on energy expenses
- See their energy use and estimated bill savings
- See their solar system's performance using the SunPower monitoring website or mobile app



SunPower EnergyLink—Plug-and-Play Installation

This complete solution for residential and commercial monitoring and control includes the SunPower® PV Supervisor 6 (PVS6) which improves the installation process, overall system reliability, and customer experience.

- Compact footprint for improved aesthetics
- Robust cloud connectivity and comprehensive local connectivity
- Flexible configuration of devices during installation
- Consumption metering
- Revenue-grade production metering (pending)
- Web-based commissioning
- Remote diagnostics of PVS6 and inverters
- Durable UL Type 3R enclosure reduces maintenance costs
- Easy integration with SunPower eBOS



Robust Cloud Connectivity

Multiple options to maintain optimal connectivity:

- Hardwired Ethernet
- Wi-Fi
- Cellular backup



SunPower® EnergyLink™ | Residential and Commercial PVS6

SunPower Monitoring Websites

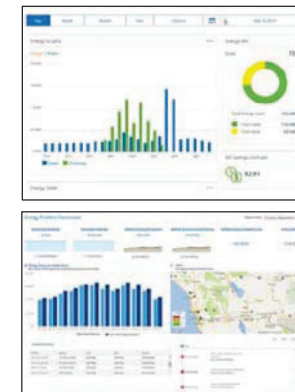

PVS6



SunPower AC Modules

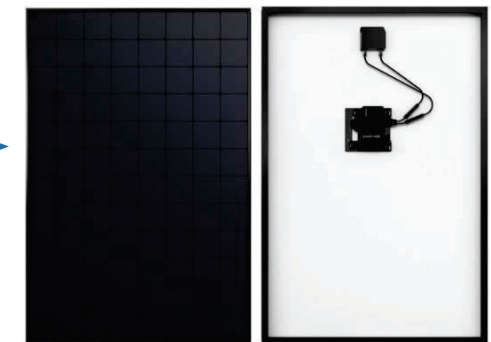

Multiple communication options include Ethernet, Wi-Fi, and cellular.

Site Requirements	
Number of SunPower AC modules supported per PVS6	85
Internet access	High-speed internet access via accessible router or switch
Power	<ul style="list-style-type: none"> • 100–240 VAC (L–N), 50 or 60 Hz • 208 VAC (L–L in 3-phase), 60 Hz

Mechanical	
Weight	5.5 lbs (2.5 kg)
Dimensions	11.8 × 8.0 × 4.2 in. (30.5 × 20.5 × 10.8 cm)
Enclosure rating	UL50E Type 3R

Web and Mobile Device Support	
Customer site	monitor.us.sunpower.com
Partner site	pvsmgmt.us.sunpower.com
Browsers	Firefox, Safari, and Chrome
Mobile devices	iPhone®, iPad®, and Android™
Customer app	<ol style="list-style-type: none"> 1. Create account online at: monitor.us.sunpower.com. 2. On a mobile device, download the SunPower Monitoring app from Apple App Store™ or Google Play™ store. 3. Sign in using account email and password.

Operating Conditions	
Temperature	–22°F to +140°F (–30°C to +60°C)
Humidity (maximum)	95%, non-condensing

Reviewed and approved
Richard Pantel, P.E.
NC Lic. No. 043326

Communication	
RS-485	Inverters and meters
Integrated Metering	<ul style="list-style-type: none"> • One channel of revenue-grade production metering • Two channels of consumption metering
Ethernet	1 LAN (or optional WAN) port
PLC	PLC for SunPower AC modules
Wi-Fi	802.11b/g/n 2.4 GHz and 5 GHz
Cellular	LTE Cat-M1/3G UMTS
ZigBee	IEEE 802.15.4 MAC, 2.4GHz ISM band
Data Storage	60 days
Upgrades	Automatic firmware upgrades

Warranty and Certifications	
Warranty	10-year Limited Warranty
Certifications	UL, cUL, CE, UL 61010-1 and -2, FCC Part 15 (Class B)



© 2019 SunPower Corporation. All rights reserved. SUNPOWER, SUNPOWER logo, and ENERGYLINK are trademarks or registered trademarks of SunPower Corporation. iPhone and iPad are registered trademarks of Apple Inc. Android and Google Play are trademarks of Google Inc. All other trademarks are the property of their respective owners. Specifications included in this datasheet are subject to change without notice.

530536 RevC





SunPower® InvisiMount™ | Residential Mounting System

Simple and Fast Installation

- Integrated module-to-rail grounding
- Pre-assembled mid and end clamps
- Levitating mid clamp for easy placement
- Mid clamp width facilitates consistent, even module spacing
- UL 2703 Listed integrated grounding

Flexible Design

- Addresses nearly all sloped residential roofs
- Design in landscape and portrait with up to 8' rail span
- Pre-drilled rails and rail splice
- Rails enable easy obstacle management

Customer-Preferred Aesthetics

- #1 module and #1 mounting aesthetics
- Best-in-class system aesthetics
- Premium, low-profile design
- Black anodized components
- Hidden mid clamps and capped, flush end clamps

Part of Superior System

- Built for use with SunPower DC and AC modules
- Best-in-class system reliability and aesthetics
- Optional rooftop transition flashing, rail-mounted J-box, and wire management rail clips
- Combine with SunPower modules and SunPower EnergyLink® monitoring app

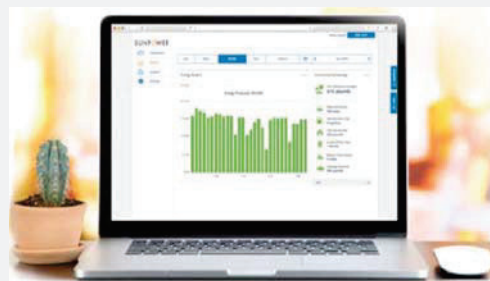

Elegant Simplicity

SunPower® InvisiMount™ is a SunPower-designed rail-based mounting system. The InvisiMount system addresses residential sloped roofs and combines faster installation time, design flexibility, and superior aesthetics. The InvisiMount product was specifically envisioned and engineered to pair with SunPower modules. The resulting system-level approach amplifies the aesthetic and installation benefits—for homeowners and for installers.

sunpower.com



SunPower® InvisiMount™ | Residential Mounting System

InvisiMount Components

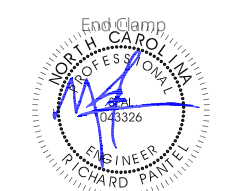
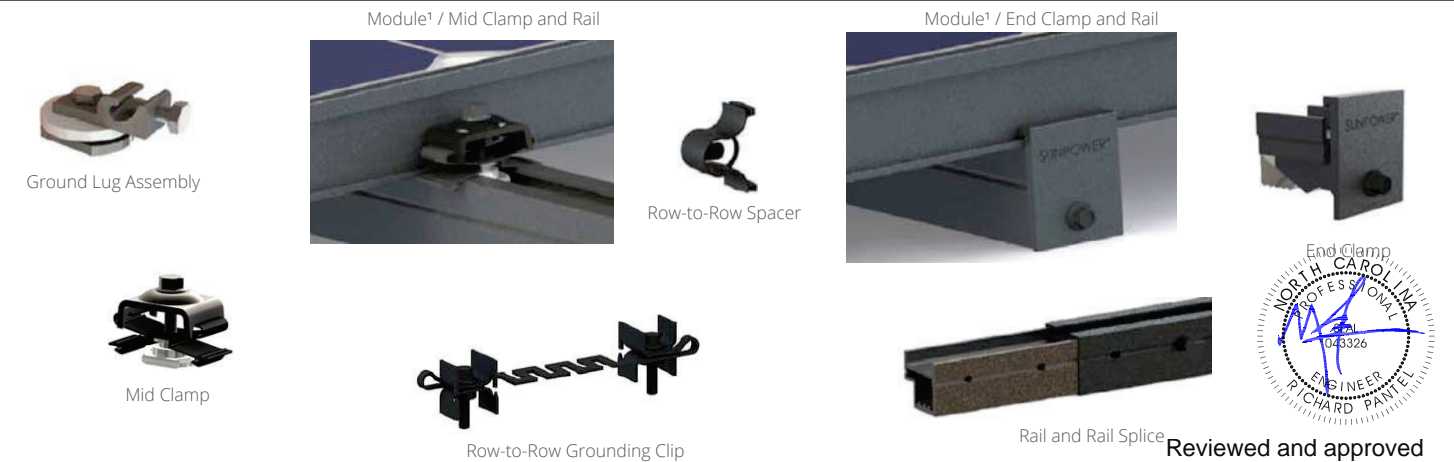

Reviewed and approved
Richard Pantel, P.E.
NC Lic. No. 043326

InvisiMount Component Details		
Mid clamp	Black oxide stainless steel 300 series	63 g (2.2 oz)
End clamp	Black anodized aluminum 6000 series	110 g (3.88 oz)
Rail	Black anodized aluminum 6000 series	830 g/m (9 oz/ft)
Rail splice	Aluminum alloy 6000 series	830 g/m (9 oz/ft)
Rail bolt	M10-1.5 × 25 mm; custom T-head SS304	18 g (0.63 oz)
Rail nut	M10-1.5; DIN 6923 SS304	nominal
Ground lug assembly	SS304; A2-70 bolt; tin-plated copper lug	106.5 g (3.75 oz)
Row-to-row grounding clip	SS 301 with SS 304 M6 bolts	75 g (2.6 oz)
Row-to-row spacer	Black POM-grade plastic	5 g (0.18 oz)

InvisiMount Operating Conditions	
Temperature	-40° C to 90° C (-40° F to 194° F)
Max. Load (LRFD)	<ul style="list-style-type: none"> • 3000 Pa uplift • 6000 Pa downforce

Roof Attachment Hardware Supported by Design Tool	
Application	<ul style="list-style-type: none"> • Composition Shingle Rafter Attachment • Composition Shingle Roof Decking Attachment • Curved and Flat Tile Roof Attachment • Universal interface for other roof attachments

InvisiMount Warranties And Certifications	
Warranties	<ul style="list-style-type: none"> • 25-year product warranty • 5-year finish warranty
Certifications	<ul style="list-style-type: none"> • UL 2703 Listed • Class A Fire Rated

Roof Attachment Hardware Warranties	
Refer to roof attachment hardware manufacturer's documentation.	

InvisiMount Component LRFD Capacities ²		
Mid clamp	Uplift	664 lbf
	Shear	540 lbf
End clamp	Uplift	899 lbf
	Shear	220 lbf
Rail	Moment: upward	548 lbf-ft
	Moment: downward	580 lbf-ft
Rail splice	Moment: upward	548 lbf-ft
	Moment: downward	580 lbf-ft
L-foot	Uplift	1000 lbf
	Shear	390 lbf

¹ Module frame that is compatible with the InvisiMount system required for hardware interoperability.
² SunPower recommends that all Equinox™, InvisiMount™, and AC module systems always be designed using the InvisiMount Span Tables #524734. If a designer decides to instead use the component capacities listed in this document to design a system, note that the capacities shown are Load and Resistance Factor Design (LRFD) design loads, and are NOT to be used for Allowable Stress Design (ASD) calculations; and that a licensed Professional Engineer (PE) must then stamp all calculations. If you have any questions please contact SunPower Technical Support at 1-855-977-7867.

© 2018 SunPower Corporation. All Rights Reserved. SUNPOWER, the SUNPOWER logo, EQUINOX, and INVISIMOUNT are trademarks or registered trademarks of SunPower Corporation. All other trademarks are the property of their respective owners. Specifications included in this datasheet are subject to change without notice.

SPEC SHEET

Part #	Box Quantity
17660	4" QB2 (25)
17662	3" Microflashing® (25); 4" QB2 (25); L-Foot (25)

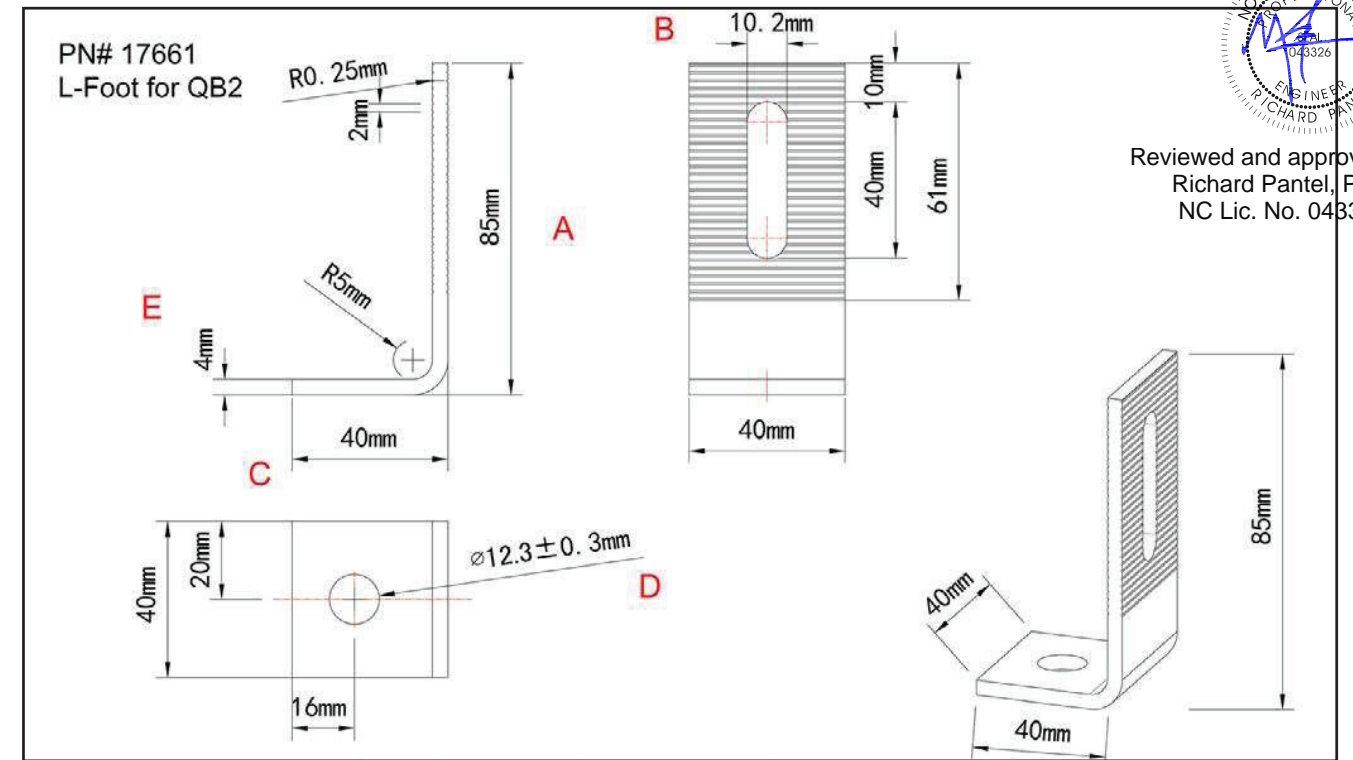
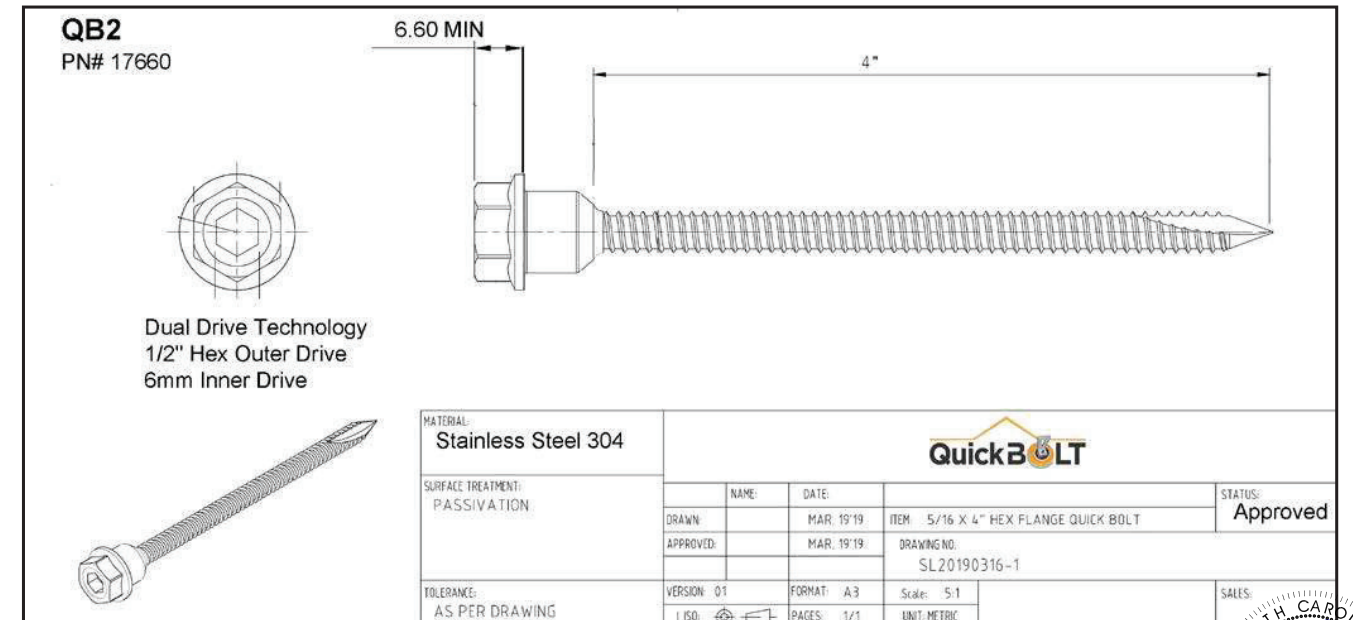

pe.eaton.com

Eaton general duty cartridge fuse safety switch

DG222NRB

UPC:782113144221

Dimensions:

- **Height:** 14.37 IN
- **Length:** 7.35 IN
- **Width:** 8.4 IN

Weight:10 LB

Notes:Maximum hp ratings apply only when dual element fuses are used. 3-Phase hp rating shown is a grounded B phase rating, UL listed.

Warranties:

- Eaton Selling Policy 25-000, one (1) year from the date of installation of the Product or eighteen (18) months from the date of shipment of the Product, whichever occurs first.

Specifications:

- **Type:** General duty, cartridge fused
- **Amperage Rating:** 60A
- **Enclosure:** NEMA 3R
- **Enclosure Material:** Painted galvanized steel
- **Fuse Class Provision:** Class H fuses
- **Fuse Configuration:** Fusible with neutral
- **Number Of Poles:** Two-pole
- **Number Of Wires:** Three-wire
- **Product Category:** General duty safety switch
- **Voltage Rating:** 240V

Supporting documents:

- [Eatons Volume 2-Commercial Distribution](#)
- [Eaton Specification Sheet - DG222NRB](#)

Certifications:

- UL Listed

Product compliance: No Data



Eaton general duty non-fusible safety switch

DG222URB

UPC:782113144238

Dimensions:

- **Height:** 14.38 IN
- **Length:** 7.38 IN
- **Width:** 8.69 IN

Weight:9 LB

Notes:WARNING! Switch is not approved for service entrance unless a neutral kit is installed.

Warranties:

- Eaton Selling Policy 25-000, one (1) year from the date of installation of the Product or eighteen (18) months from the date of shipment of the Product, whichever occurs first.

Specifications:

- **Type:** Non-fusible, single-throw
- **Amperage Rating:** 60A
- **Enclosure:** NEMA 3R, Rainproof
- **Enclosure Material:** Painted galvanized steel
- **Fuse Configuration:** Non-fusible
- **Number Of Poles:** Two-pole
- **Number Of Wires:** Two-wire
- **Product Category:** General duty safety switch
- **Voltage Rating:** 240V

Supporting documents:

- [Eatons Volume 2-Commercial Distribution](#)
- [Eaton Specification Sheet - DG222URB](#)

Certifications:

- UL Listed

Product compliance: No Data

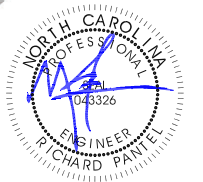

Reviewed and approved
Richard Pantel, P.E.
NC Lic. No. 043326



Eaton CH main lug loadcenter

CH8L125RP

UPC:782114190548

Dimensions:

- **Height:** 3.69 IN
- **Length:** 13 IN
- **Width:** 11 IN

Weight:12 LB

Notes:Ground bar kits priced separately. Suitable for use as service equipment when not more than two service disconnecting mains are provided or when not used as a lighting and appliance panelboard.

Warranties:

- Limited lifetime

Specifications:

- **Special Features:** Cover included
- **Type:** Main lug only
- **Amperage Rating:** 125A
- **Box Size:** 7r
- **Bus Material:** Copper
- **Enclosure:** NEMA 3R
- **Enclosure Material:** Metallic
- **Feed Type:** Overhead
- **Main Circuit Breaker:** CH
- **Number Of Circuits:** 8
- **Number Of Wires:** Three-wire
- **Phase:** Single-phase
- **Voltage Rating:** 120/240V, 208Y/120, 240V
- **Wire Size:** #6-1/0 AWG

Supporting documents:

- [Type CH Circuit Breakers and Loadcenters](#)
- [Loadcenters and Circuit Breakers](#)
- [Eatons Volume 1-Residential and Light Commercial](#)



Eaton CH main lug loadcenter

CH12L125R

UPC:782113097381

Dimensions:

- **Height:** 5.19 IN
- **Length:** 16.75 IN
- **Width:** 14.31 IN

Weight:15.8 LB

Notes:Suitable for use as service equipment when not more than six service disconnecting mains are provided or when not used as a lighting and appliance panelboard. Rainproof panels are furnished with hub closure plates. For rainproof hubs.

Warranties:

- Limited lifetime

Specifications:

- **Special Features:** Cover included
- **Type:** Main lug only
- **Amperage Rating:** 125A
- **Box Size:** B
- **Bus Material:** Copper
- **Enclosure:** NEMA 3R
- **Enclosure Material:** Metallic
- **Feed Type:** Overhead
- **Main Circuit Breaker:** CH
- **Number Of Circuits:** 12
- **Number Of Wires:** Three-wire
- **Phase:** Single-phase
- **Voltage Rating:** 120/240V
- **Wire Size:** #6-2/0 AWG

Supporting documents:

- [Dimensional Drawing - CH 3/4 LOADCENTER, MAIN LUG ONLY, OUTDOOR NEMA 3R, 120/240 VAC, 1 PH](#)

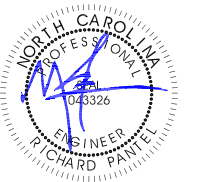

Reviewed and approved
Richard Pantel, P.E.
NC Lic. No. 043326

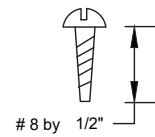
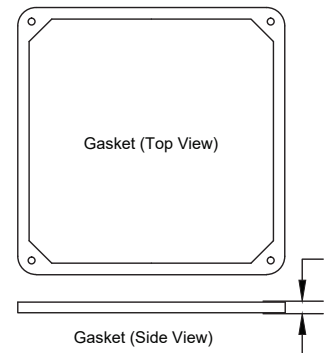
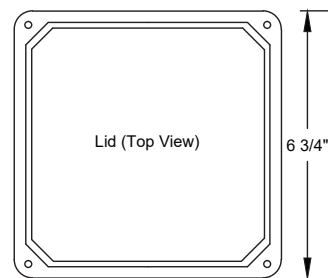
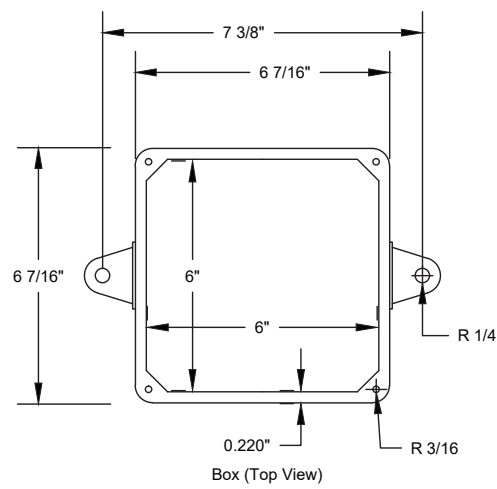
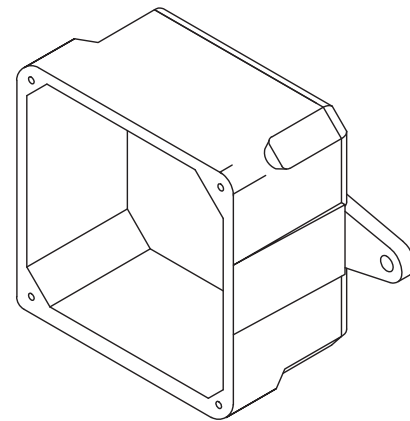
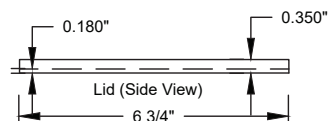
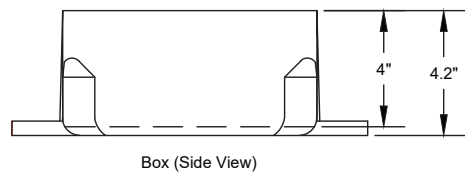

UL Listed
 Marine Listed
 UL File # E205935 (QCUP)
 UL Control # 92CM
 Material is Rigid PVC
 132 cu in Volume (2163 cu cm)
 Screws are Zinc Plated Steel
 Gasket is neoprene



CANTEX INC. Fort Worth, TEXAS		
Junction Box 6 x 6 x 4		
Drawn By: O.M.	Date: 6/19/17	5133710



Reviewed and approved
 Richard Pantel, P.E.
 NC Lic. No. 043326

1.4 Listings, Compatibility, and Classification

The SunPower InvisiMount Residential Mounting System is UL 2703 Listed. The InvisiMount Listing **includes** the following modules, which have been tested for grounding and mechanical load with the InvisiMount system.

For Classic InvisiMount certification information, refer to UL at their site <https://www.ul.com> or the at the UL portal <https://www.ul.com/resources/apps/myul-client-portal> and view *File E314938* and *File E466981*. For Universal InvisiMount certification information, refer to Intertek at [https://ramuk.intertekconnect.com/WebClients/ITS/DLP/products.nsf/\\$\\$Search?OpenForm](https://ramuk.intertekconnect.com/WebClients/ITS/DLP/products.nsf/$$Search?OpenForm) and view *Control Number 5024883*.

SunPower DC Modules	SunPower AC Modules	
<ul style="list-style-type: none"> • SPR-A400-BLK-DC • SPR-A400-DC • SPR-A410-DC • SPR-E19-320 • SPR-E20-327 • SPR-X21-335-BLK • SPR-X21-350-BLK • SPR-X21-345 • SPR-X22-360 • SPR-X22-370 	<ul style="list-style-type: none"> • SPR-A400-BLK-G-AC • SPR-A390-G-AC • SPR-A400-G-AC • SPR-A410-G-AC • SPR-A415-G-AC • SPR-A425-G-AC • SPR-M415-BLK-H-AC • SPR-M425-BLK-H-AC • SPR-M420-H-AC • SPR-M435-H-AC • SPR-M440-H-AC 	<ul style="list-style-type: none"> • SPR-X22-370-E-AC • SPR-X22-360-E-AC • SPR-X21-350-BLK-E-AC • SPR-X21-335-BLK-E-AC • SPR-X20-327-BLK-E-AC • SPR-X21-345-E-AC • SPR-X21-335-E-AC • SPR-X20-327-E-AC • SPR-E20-327-E-AC • SPR-E19-320-E-AC

With Universal InvisiMount:

Manufacturer	Module Model / Series
SunPower	<ul style="list-style-type: none"> • SPR-Axxx-COM (may be followed by -BLK), where xxx can be 380–460. • SPR-Axxx-yyy-MLSD, where xxx can be 350–460 and where yyy can be -COM and/or -300 V.
Aptos	<ul style="list-style-type: none"> • DNA-120-MF26-xxxW, where xxx is wattage. • DNA-108-BF10-xxxW, where xxx is wattage. • DNA-120-BF26-xxxW where xxx is 350–370.
Hanwha	<ul style="list-style-type: none"> • Q.PEAK DUO BLK ML-G10.a+ xxx, where xxx can be 370–425.

REC	<ul style="list-style-type: none"> • RECxxxNP2, where xxx can be 350–380. • RECxxxNP2 Black, where xxx can be 350–380. • RECxxxTP4, where xxx can be 350–380. • RECxxxTP4 Black, where xxx can be 350–380. • RECxxxAA, where xxx can be 340–385. • RECxxxAA Black, where xxx can be 340–385. • RECxxxAA Pure, where xxx can be 380–415.
Trina	<ul style="list-style-type: none"> • TSM-xxxDE06X.05(II), where xxx can be 355–380.
Jinko	<ul style="list-style-type: none"> • JKMxxxM-6RL3-B, where xxx can be 365–400.
Canadian Solar	<ul style="list-style-type: none"> • Canadian Solar: CS3NxxxMS where xxx is 380–405.
Waaree	<ul style="list-style-type: none"> • WSMDi-xxx where xxx is 395–415.

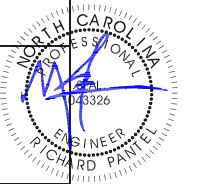

Reviewed and approved
Richard Pantel, P.E.
NC Lic. No. 043326

System Design Load Rating: 10 PSF downward, 5 PSF upward, 5 PSF lateral. Actual system structural capacity is defined by the *InvisiMount Span Tables 524734*.

Grounding from the module to the rail is accomplished through the clamps. See Section 1.5 for more information. The Listing also includes the following components, which have been evaluated for both mounting and bonding in accordance with UL 2703:

- End clamp
- Mid clamp
- Rail
- Splice and splice screw
- Ground lug assembly
- L-foot
- Row-to-row (R2R) grounding clip
- Row-to-row (R2R) grounding jumper
- Row-to-row (R2R) spacer
- Rail-mounted grounding junction box (RMJ)

SunPower Universal InvisiMount™ Ground Path and Compliance

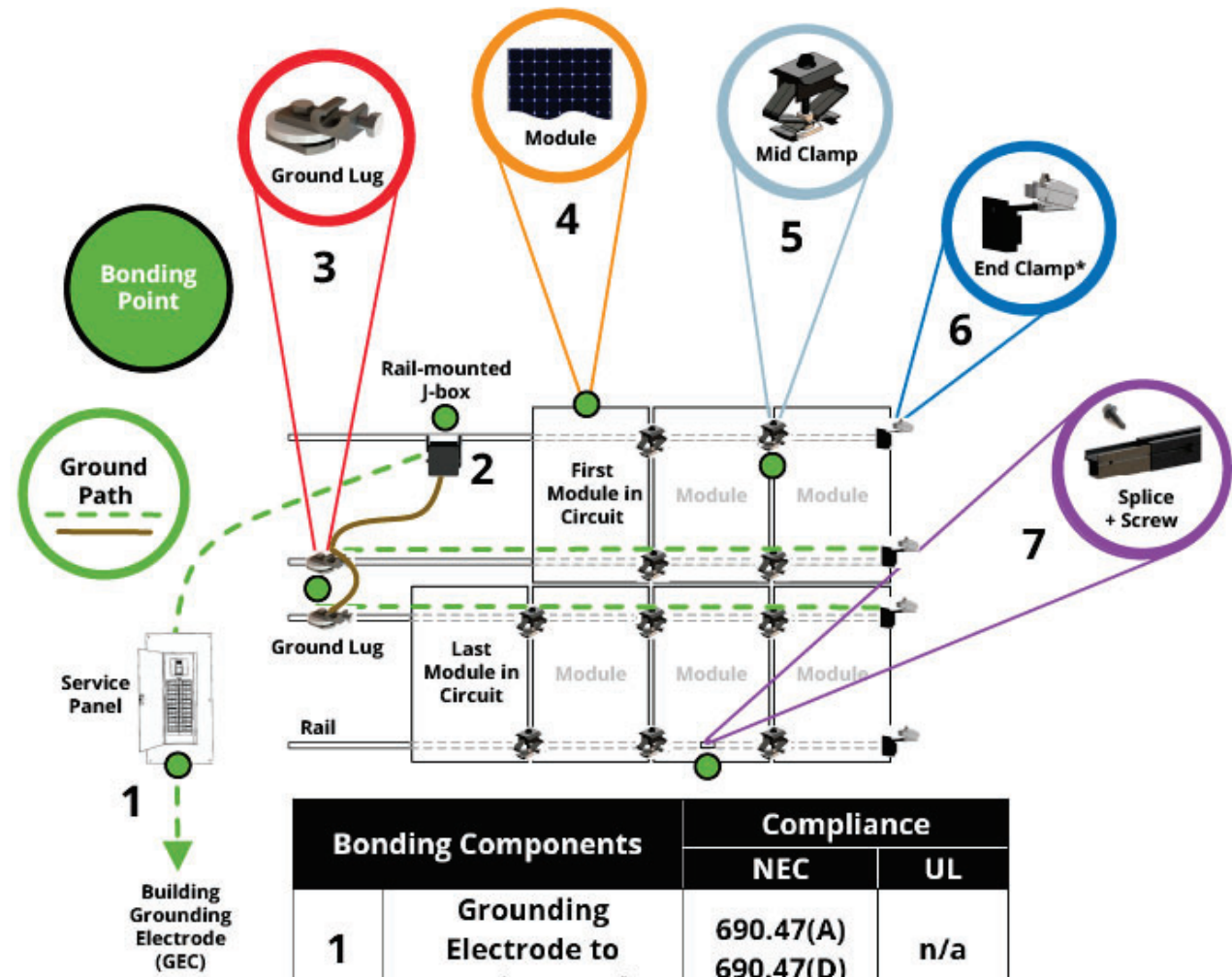

Bonding Components	Compliance	
	NEC	UL
1 Grounding Electrode to Service Panel	690.47(A) 690.47(D)	n/a
2 Service Panel to Ground Wire	690.43(C)	1741
3 Ground Wire to Ground Lug to Rail	690.43(C)	2703
4 Module Frame	n/a	1703
5 Rail to Mid Clamp to Module Frame	690.43(A) 690.43(C) 690.43(D)	2703
6 End Clamp to Rail* *Note that end clamp does not bond module to rail; mid clamp bonds module to rail.	690.43(A) 690.43(C) 690.43(D)	2703
7 Rail to Splice	690.43(A) 690.43(C) 690.43(D)	2703

SunPower Universal InvisiMount™ with Grounding Jumper Ground Path and Compliance

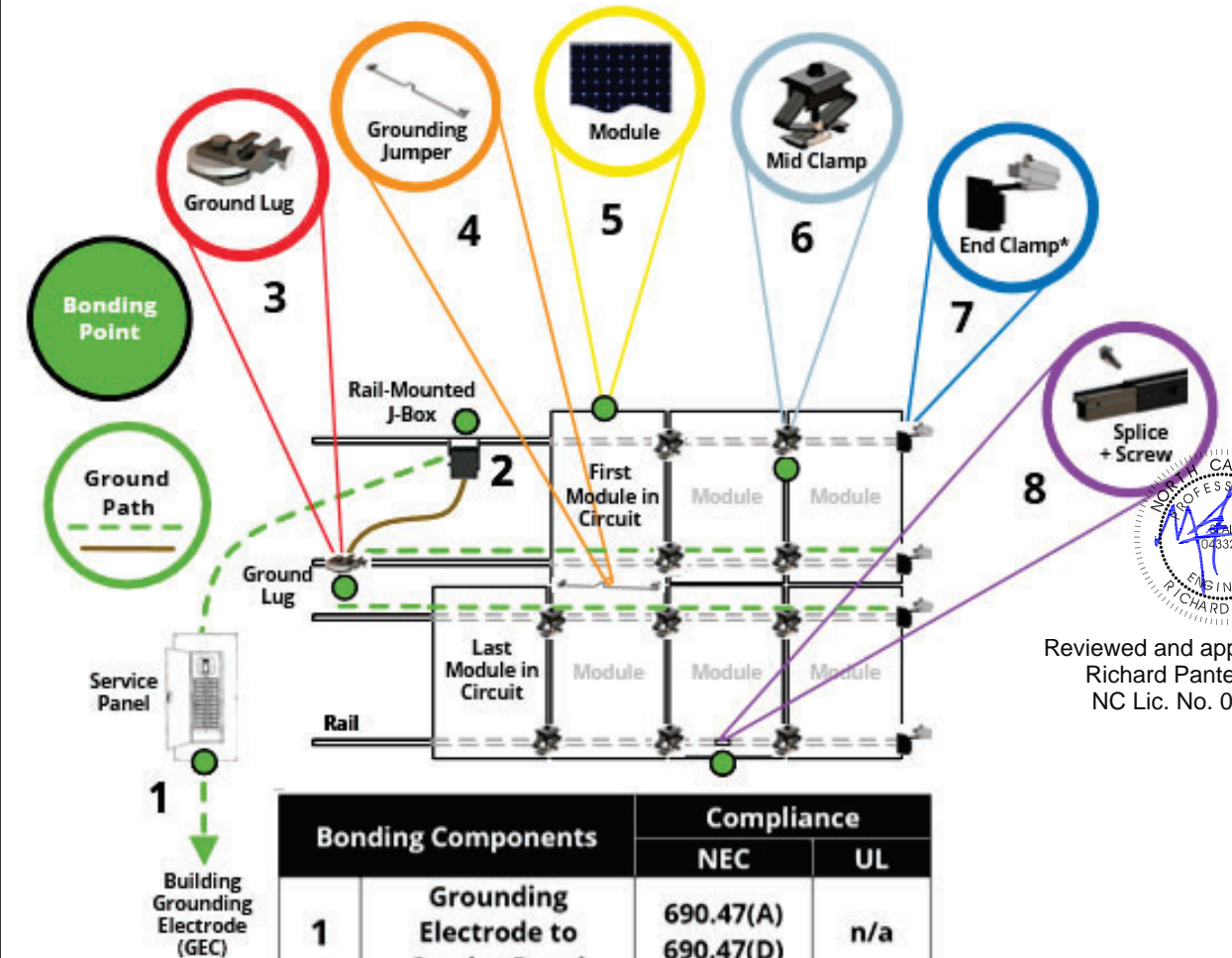

Bonding Components	Compliance	
	NEC	UL
1 Grounding Electrode to Service Panel	690.47(A) 690.47(D)	n/a
2 Service Panel to Ground Wire	690.43(C)	1741
3 Ground Wire to Ground Lug to Rail	690.43(C)	2703
4 Module Frame to Module Frame	690.43(C)	2703
5 Module Frame	n/a	1703
6 Rail to Mid Clamp to Module Frame	690.43(A) 690.43(C) 690.43(D)	2703
7 End Clamp to Rail* *Note that end clamp does not bond module to rail; mid clamp bonds module to rail.	690.43(A) 690.43(C) 690.43(D)	2703
8 Rail to Splice	690.43(A) 690.43(C) 690.43(D)	2703

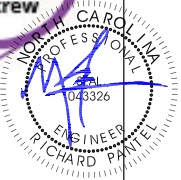

Reviewed and approved
Richard Pantel, P.E.
NC Lic. No. 043326

July 29, 2022

To whom it may concern,

This letter confirms and attests that:

SPWR-A5 is equivalent to Enphase Models:

IQ7HS-66-ACM-US, 369 VA, 208Vac Grid Support Utility Interactive Inverter
IQ7HS-66-E-ACM-US, 369 VA, 208Vac Grid Support Utility Interactive Inverter
IQ7HS-66-M-US, 369 VA, 208Vac Grid Support Utility Interactive Inverter
IQ7HS-66-ACM-US, 384 VA, 240Vac Grid Support Utility Interactive Inverter
IQ7HS-66-E-ACM-US, 384 VA, 240Vac Grid Support Utility Interactive Inverter
IQ7HS-66-M-US, 384 VA, 240Vac Grid Support Utility Interactive Inverter



Reviewed and approved
Richard Pantel, P.E.
NC Lic. No. 043326

Regards,



Aranjit Sangha
Senior Staff Engineer
Enphase Energy Inc.
1420 North McDowell Blvd.
Petaluma, CA 94954
v: (707) 763-4784 x7098
asangha@enphaseenergy.com