

**Project Details**

<b>Name</b>	Carlton Parnell	<b>Date</b>	05/29/2023
<b>Location</b>	207 Deanne Lane, Coats, NC 27521	<b>Total modules</b>	18
<b>Module</b>	Mission Solar Energy: MSE395SX9R (40mm)	<b>Total watts</b>	7,110
<b>Dimensions</b>	Dimensions: 75.08" x 41.5" x 1.57" (1907.0mm x 1054.0mm x 40.0mm)	<b>Attachments</b>	40
<b>ASCE</b>	7-10	<b>Rails per row</b>	2

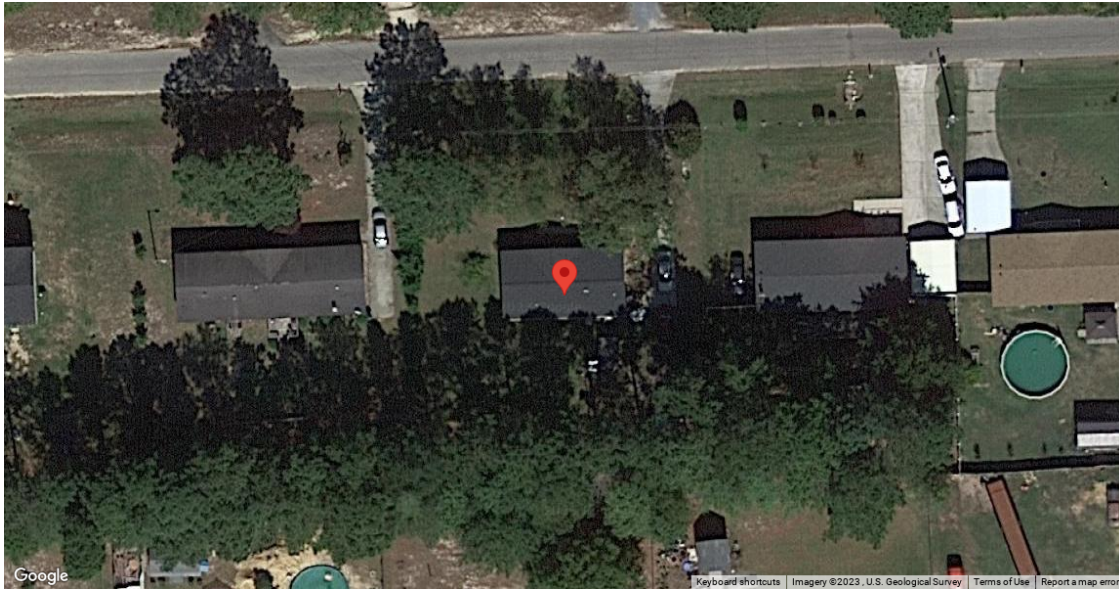

System Weight	
<b>Total system weight</b>	1,004.4 lbs
<b>Weight/attachment</b>	25.1 lbs
<b>Racking weight</b>	131.4 lbs
<b>Distributed weight</b>	2.5 psf

Load Assumptions	
<b>Wind exposure</b>	C
<b>Wind speed</b>	119 mph
<b>Ground snow load</b>	15 psf
<b>Attachment spacing portrait</b>	4.0'

Roof Information			
<b>Roof Material Family</b>	Comp Shingle	<b>Roof material</b>	Comp Shingle
<b>Building height</b>	15 ft	<b>Roof attachment</b>	Flashfoot2
		<b>Staggered attachments</b>	Yes
<b>Roof slope</b>	12 °	<b>Attachment hardware</b>	Square
<b>Risk category</b>	II		
<b>Specific gravity</b>	0.42		

Span Details XR10 - Portrait		
Zone	Max span	Max cantilever
1	5' 8"	2' 3"
2	5' 6"	2' 2"
3	4' 5"	1' 9"

Reaction Forces XR10 - Portrait				
Zone	Uplift (PSF)	Down (lbs)	Uplift (lbs)	Lateral (lbs)
1	13.9	250	152	42
2	25.7	250	307	42
3	39.6	250	484	42

**Roof Section 1**

Details		Weights
Panels: 15	Provided rail: 168' [12 x 168"]	Total weight: 838.9 lbs
Rail orientation: East-West	Attachments: 33	Weight/attachment: 25.4 lbs
Panel orientation: Portrait	Splices: 6	Total Area: 330.0 sq ft
Entry type: Graphical	Clamps: 36	Distributed weight: 2.5 psf

**Diagram**

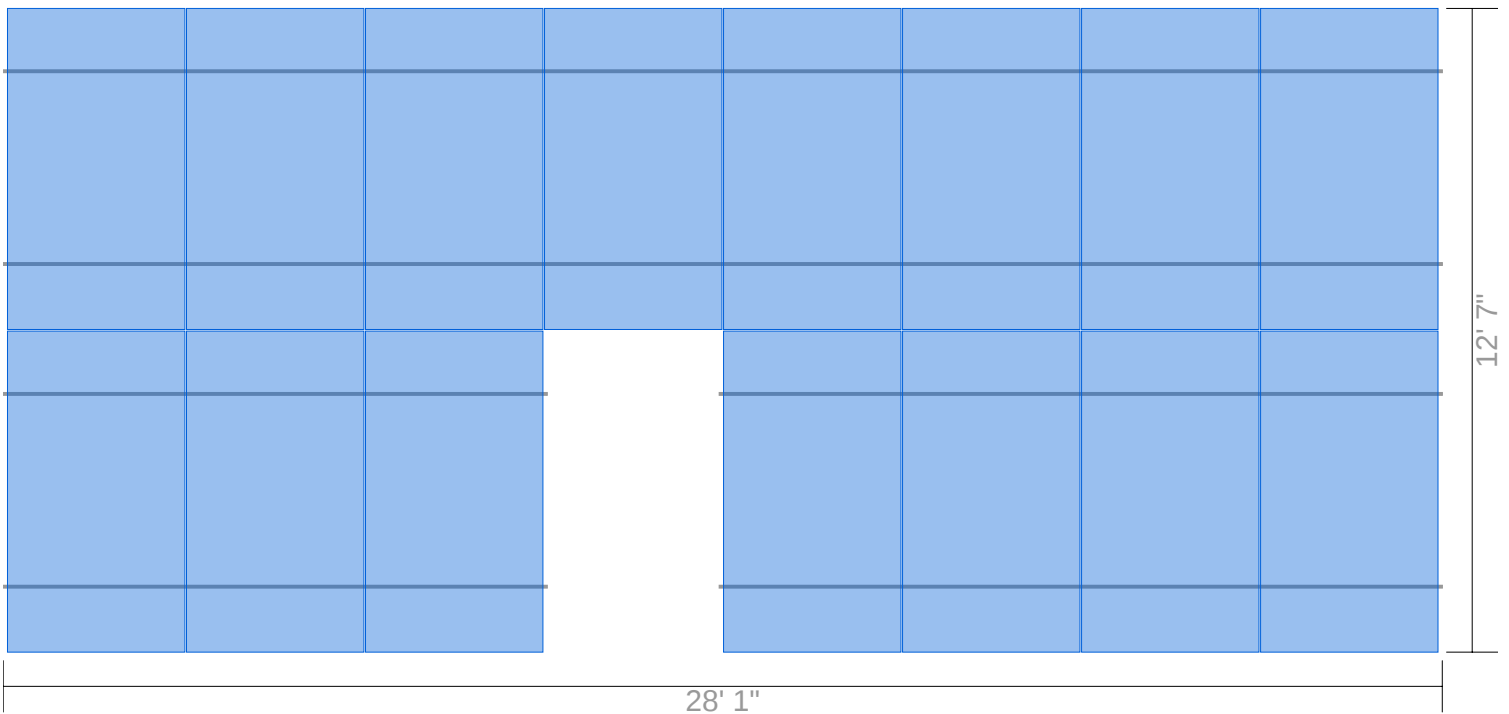

**Segments**

Identifier	Columns	Row length	Rail length	Cantilever	Rail	Attachments	Splices	Clamps
A	8	28' 1"	28' 1"	0"	84' [6 x 168"]	17	4	18
B	3	10' 7"	10' 7"	1' 4"	28' [2 x 168"]	7	0	8
C	4	14' 1"	14' 1"	1' 1"	56' [4 x 168"]	9	2	10

**Roof Section 2**

Details		Weights
Panels: 3	Provided rail: 28' [2 x 168"]	Total weight: 165.5 lbs
Rail orientation: East-West	Attachments: 7	Weight/attachment: 23.6 lbs
Panel orientation: Portrait	Splices: 0	Total Area: 66.3 sq ft
Entry type: Graphical	Clamps: 8	Distributed weight: 2.5 psf

**Diagram**

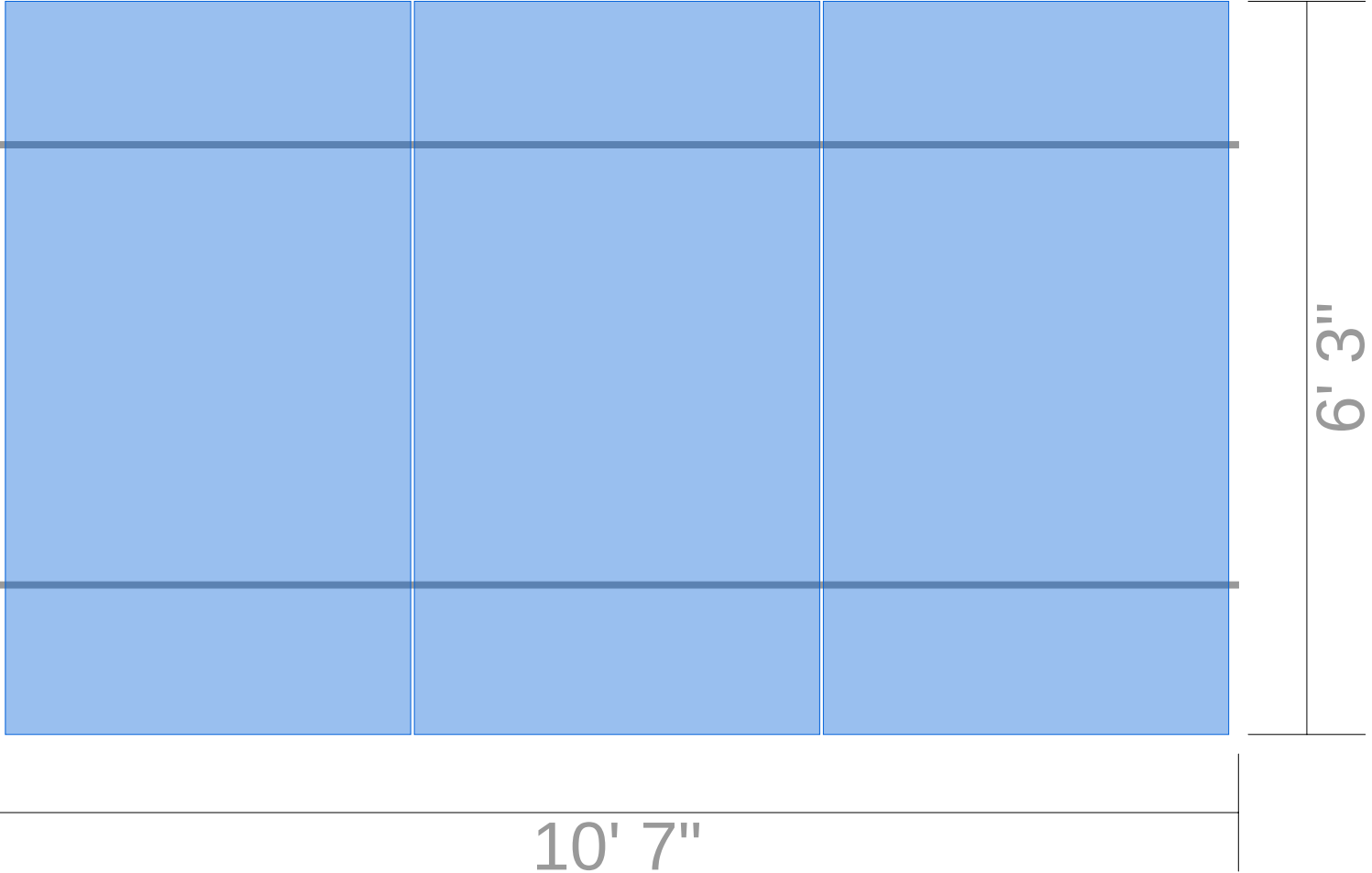

**Segments**

Identifier	Columns	Row length	Rail length	Cantilever	Rail	Attachments	Splices	Clamps
A	3	10' 7"	10' 7"	1' 4"	28' [2 x 168"]	7	0	8

**Side View (portrait)**

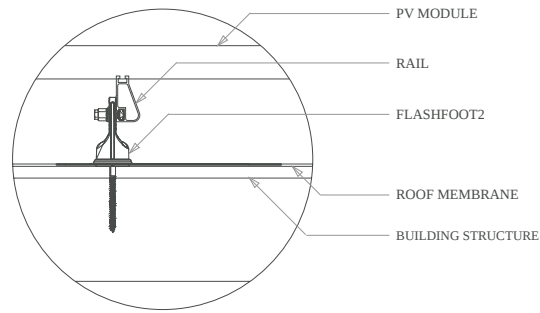
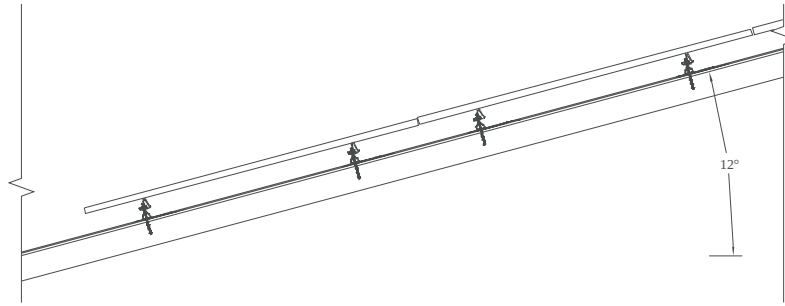

**Front View (portrait)**

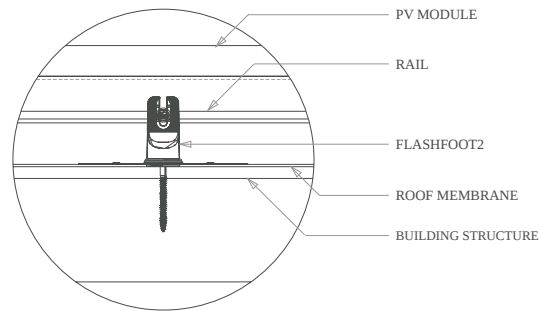
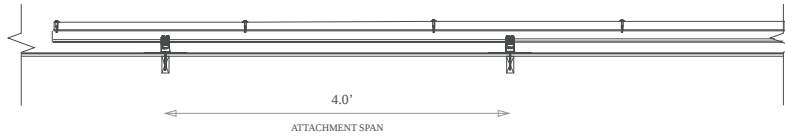

**Splice Details**

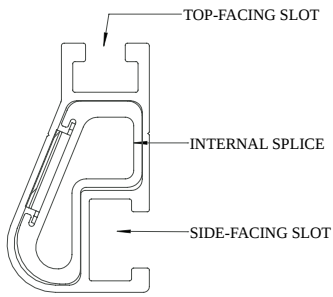

XR10

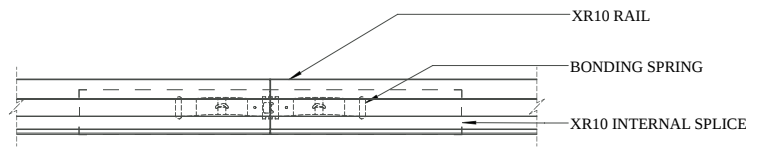

Splice Connection

**Clamp Detail**

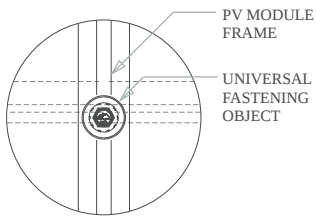

Mid Clamp, Plan

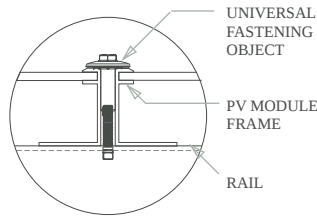

Mid Clamp, Front

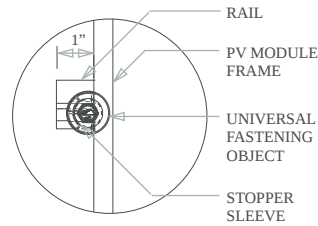

End Clamp, Plan

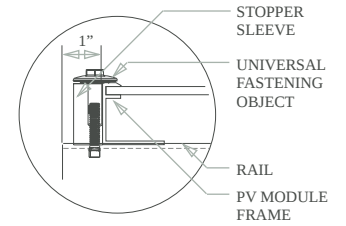

End Clamp, Front

**FlashFoot2 Detail**

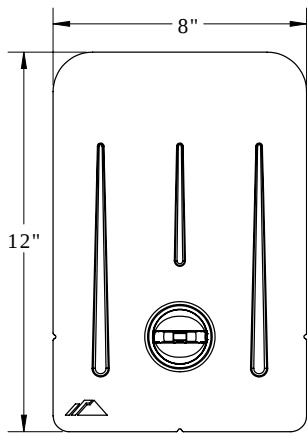

Plan View

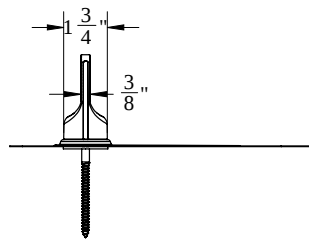

Side View

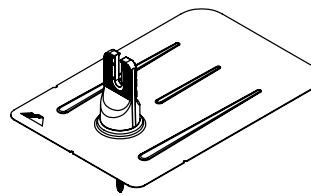

Perspective View

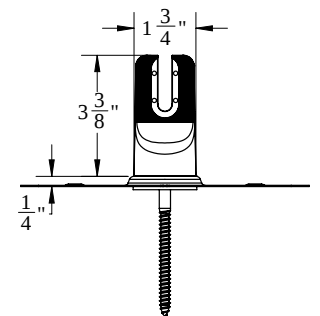

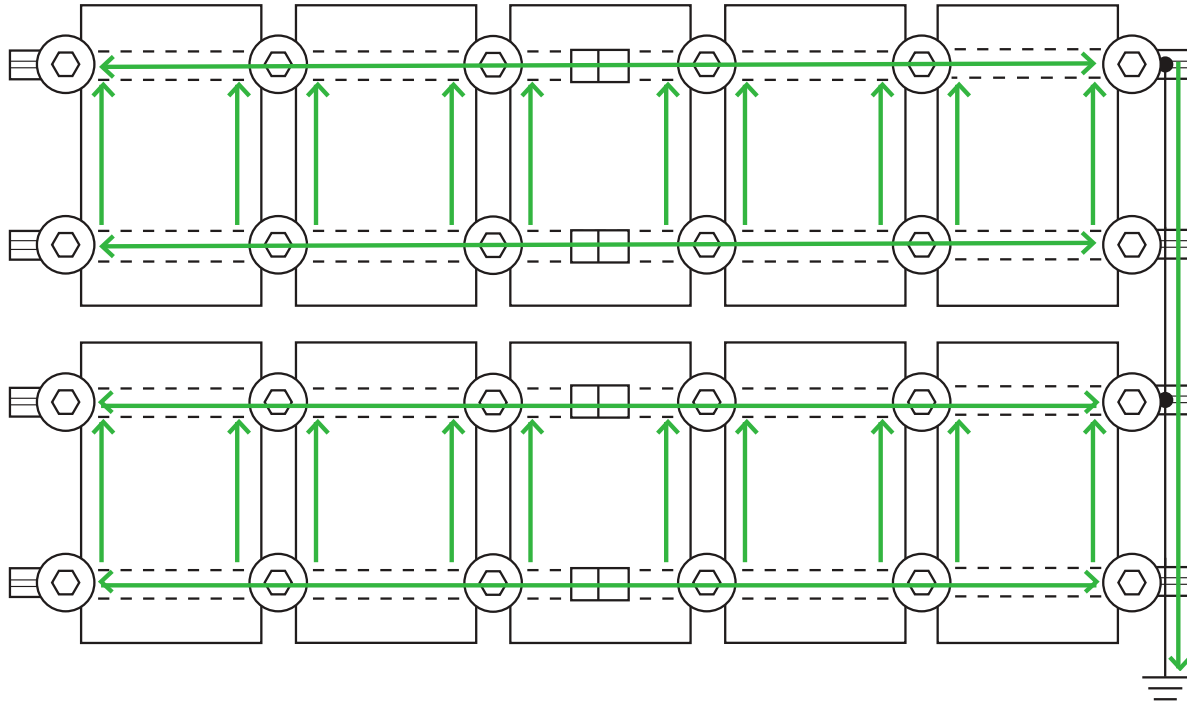

Front View

### Grounding Diagram



 UFO Clamp

 Fault Current Ground Path

 Grounding Lug \*

 Min 10 AWG Copper Wire \*

 Bonded Splice (Rail Connection)

\* Grounding Lugs and Wire are not required in systems using Enphase microinverters.

**Bill of Materials**

<b>Part</b>	<b>Spares</b>	<b>Total Qty</b>
-------------	---------------	------------------

**Rails & Splices**

XR-10-168B XR10, Rail 168" Black	0	14
-------------------------------------	---	----

XR10-BOSS-01-M1 Bonded Splice, XR10	0	6
--	---	---

**Clamps & Grounding**

UFO-CL-01-B1 Universal Module Clamp, Black	0	44
---	---	----

UFO-STP-40MM-B1 Stopper Sleeve, 40MM, Black	0	16
--	---	----

XR-LUG-03-A1 Grounding Lug, Low Profile	0	4
--	---	---

**Attachments**

FF2-02-B2 FlashFoot2, Black	0	40
--------------------------------	---	----

BHW-SQ-02-A1 Square-Bolt Bonding Hardware	0	40
--	---	----

# ATTACHMENTS

## PRE-INSTALLATION

- Verify module compatibility. See [Page 21](#) for info.

## TOOLS REQUIRED

- |                                 |                       |
|---------------------------------|-----------------------|
| □ Cordless Drill (non-impact)   | □ 3/8" Socket         |
| □ Impact Driver (for lag bolts) | □ 1/8" Drill Bit      |
| □ Torque Wrench (0-250 in-lbs)  | □ 1/4" Drill Bit      |
| □ 7/16" Socket                  | □ T30 Bit             |
| □ 1/2" Socket                   | □ Channel Lock Pliers |
| □ 9/16" Socket                  | □ #3 Phillips Bit     |
| □ 7/32" Drill Bit               | □ 3/16" Hex Bit       |

## BONDING HARDWARE TORQUE VALUES

Please refer to each attachment's individual section for full details on all torque values and instructions.

- 3/8" Bonding Hardware Nuts (7/16" Socket): 250 in-lbs
- All Tile Hook Carriage Bolts (7/16" Socket): 132 in-lbs
- Flat Roof Attachment Nuts (9/16" Socket): 250 in-lbs
- Lynx Set Screw (3/16" Hex Drive): 150 in-lbs
- Lynx Flange Nut (1/2" Socket): 150 in-lbs

➤ If using previous version of Integrated Grounding Mid Clamps, End Clamps, Expansion Joints and for a list of approved 3rd party components please refer to Alternate Components Addendum (Version 1.9)

## ATTACHMENTS

### COMPOSITION SHINGLE



FlashFoot2

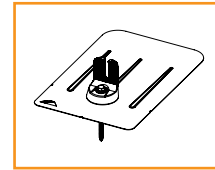

FlashVue

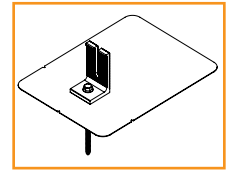

QM L-Mount

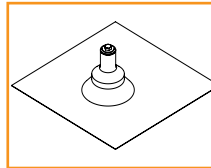

QM QBase

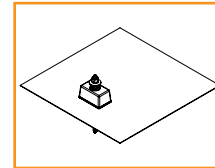

QM Classic Comp Mount

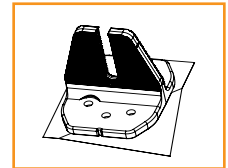

HUG (Halo UltraGrip)

### TILE

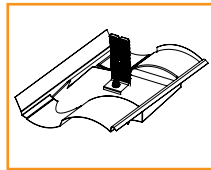

Knockout Tile

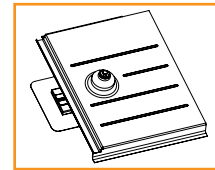

QM Tile Replacement

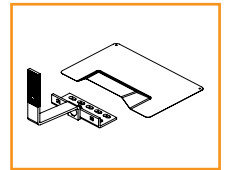

All Tile Hook and Flashing (optional)

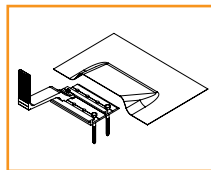

QM Quick Hook and Flashing (optional)

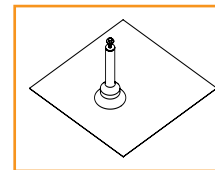

QM QBase Tile

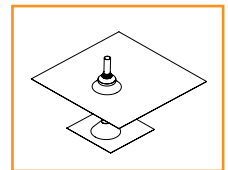

QM Tile Conduit Penetration

### ADDITIONAL ROOF TYPES

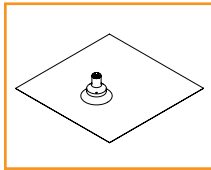

QM Qbase Shake - Slate - Metal Shingle

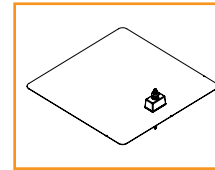

QM Classic Mount Shake

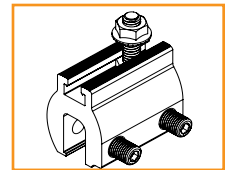

QM Lynx Metal Roof Attachment

### LOW SLOPE ROOF

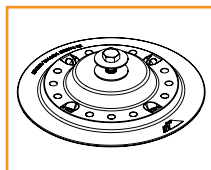

Flat Roof Attachment

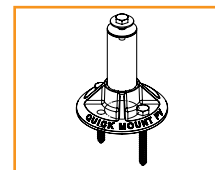

QM QBase Mount



# COMPONENTS

## PRE-INSTALLATION

- Verify module compatibility. See [Page 21](#) for info.

## TOOLS REQUIRED

- Cordless Drill (non-impact)
- Impact Driver (for lag bolts)
- Torque Wrench (0-250 in-lbs)
- 7/16" Socket
- 1/2" Socket
- 9/16" Socket
- 7/32" Drill bit
- 1/8" Drill bit
- 1/4" Drill bit
- T30 Torx Bit
- Channel Lock Pliers
- #3 Phillips Bit
- Paddle Bit

## BONDING HARDWARE TORQUE VALUES

Please refer to each attachment's individual section for full details on all torque values and instructions.

- Universal Fastening Object (7/16" Socket): 80 in-lbs
- Rail Grounding Lug Nut (7/16" Socket): 80 in-lbs
- Module Grounding Lug
  - Grounding Nut (7/16" Socket): 60 in-lbs
  - Grounding Lug Terminal Screws (7/16" Socket): 20 in-lbs
- Microinverter Kit Nuts (7/16" Socket): 80 in-lbs
- Frameless Module Kit Nuts (7/16" Socket): 80 in-lbs
- 3/8" Bonding Hardware Nuts (7/16" Socket): 250 in-lbs
- Contour Clamp (T-30 Torx Bit): 80 in-lbs

➤ Unless otherwise noted, all components have been evaluated for multiple use. They can be uninstalled and reinstalled in the same or new location.

## COMPONENTS



XR Rail



Wire Clip

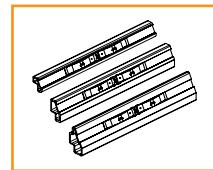

BOSS

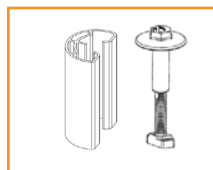

UFO and Stopper Sleeve (30-46MM)



CAMO

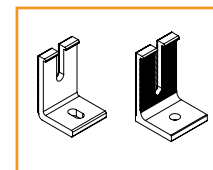

Ironridge L-Foot and QM L-Foot



End Cap

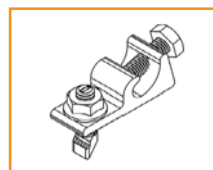

Rail Grounding Lug

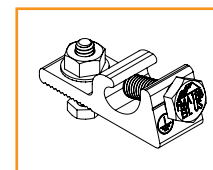

Module Grounding Lug

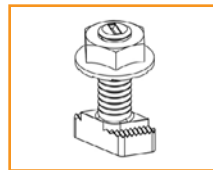

Microinverter Kit

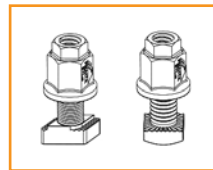

3/8" Bonding Hardware

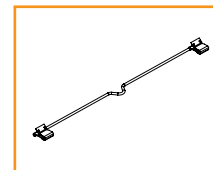

8" Bonding Jumper Single Use Only

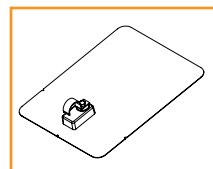

QM Classic Conduit Comp Mount

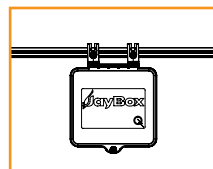

JAYBOX

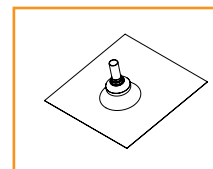

QM Composition Conduit Penetration

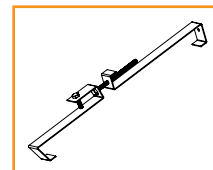

QM Tile Conduit Mount



Frameless End/Mid Clamp

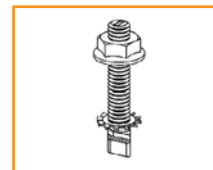

Frameless Module Kit

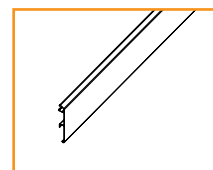

Contour Trim

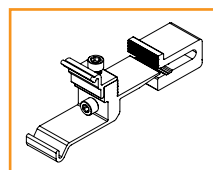

Contour Clamp

