

## SCOPE OF WORK

TO INSTALL A SOLAR PHOTOVOLTAIC (PV) SYSTEM AT THE DAVID RESIDENCE, LOCATED AT 81 CHICORA CLUB DRIVE, DUNN, NORTH CAROLINA. THE POWER GENERATED BY THE PV SYSTEM WILL BE INTERCONNECTED WITH THE UTILITY GRID THROUGH THE EXISTING ELECTRICAL SERVICE EQUIPMENT. THE PV SYSTEM DOES NOT INCLUDE STORAGE BATTERIES.

## SYSTEM RATING

21.75 kW DC STC  
19.2 kW AC

## EQUIPMENT SUMMARY

(50) SUNPOWER SPR-M435-H-AC PV MODULES  
(50) SUNPOWER SPR-M435-H-AC [240V] PV INVERTERS  
(387) (36 X 10.75') LINEAR FEET SUNPOWER INVISIMOUNT

**PHASE 2 ADDITION OF (1)  
POWERWALL TO EXISTING SYSTEM**

## SHEET INDEX

PV-0 COVER  
PV-1 SITE MAP AND PV LAYOUT  
PV-1A RACKING PLAN  
PV-2 STRING MAP AND MONITORING LAYOUT  
PV-3 ELECTRICAL DIAGRAM  
PV-4 EQ WALL & MOUNTING DETAIL  
PV-5 SYSTEM LABELING DETAIL  
PV-6 SITE DIRECTORY PLACARD  
PV-7 SAFETY PLAN

## GOVERNING CODES

2017 NATIONAL ELECTRICAL CODE  
2015 INTERNATIONAL RESIDENTIAL CODE  
UNDERWRITERS LABORATORIES (UL) STANDARDS  
OSHA 29 CFR 1910.269

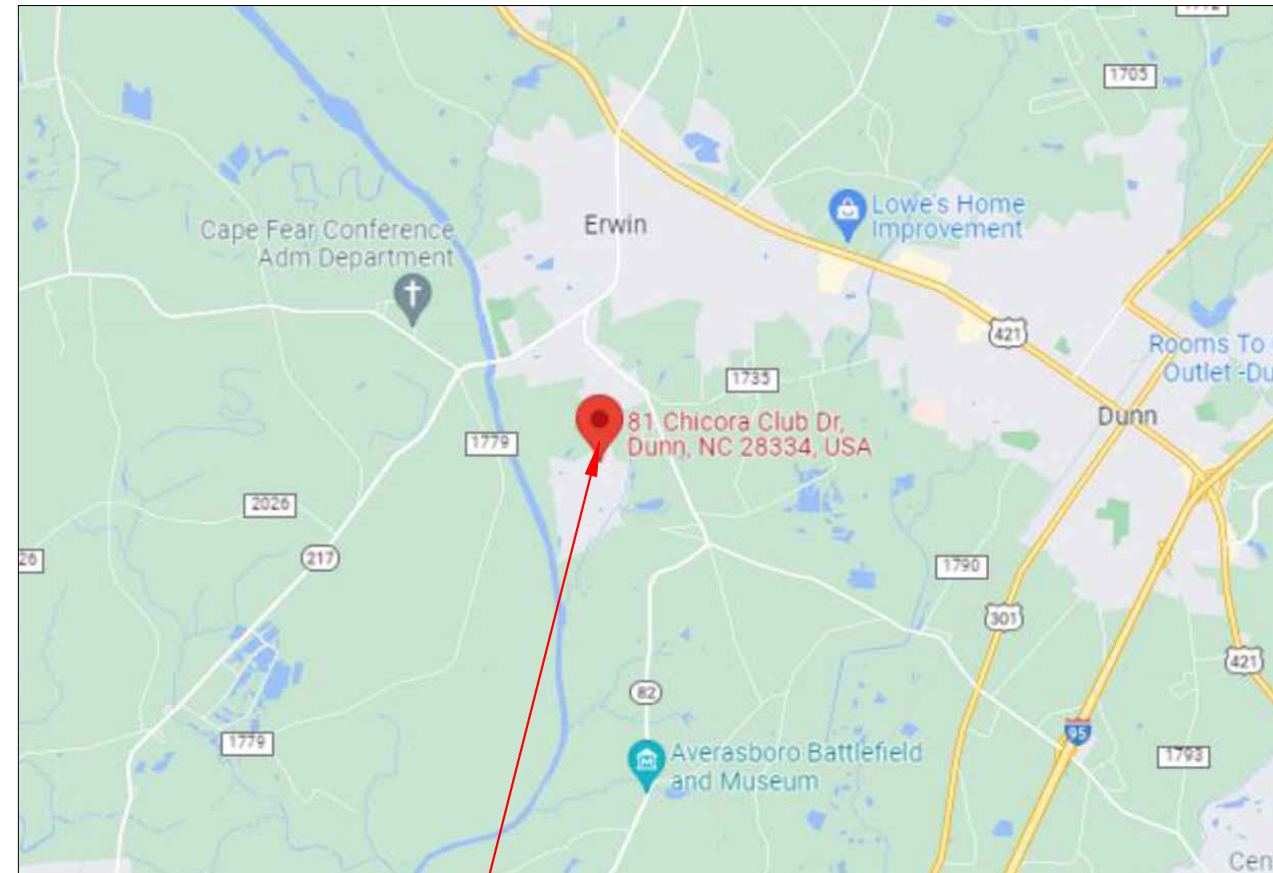

PROJECT LOCATION

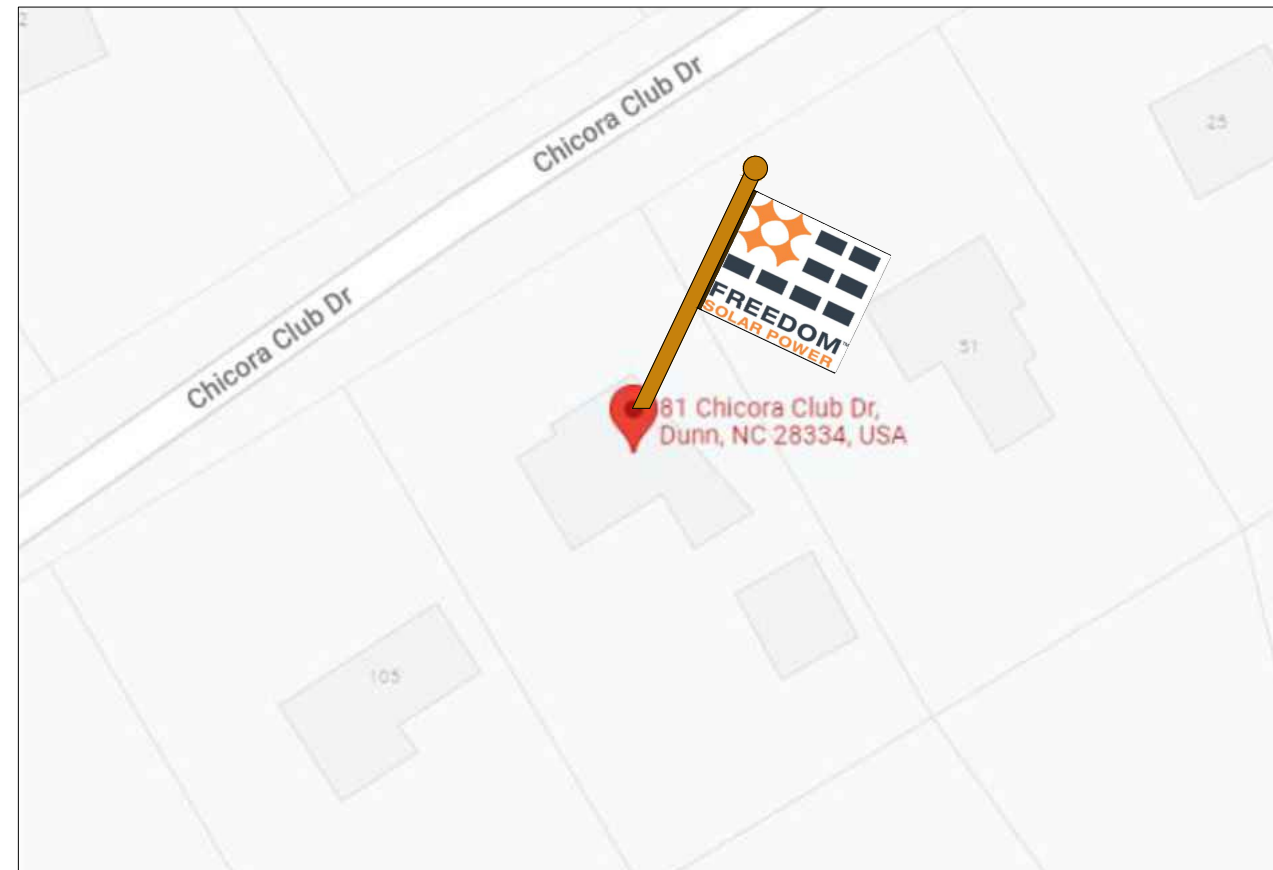

VICINITY MAP

DESIGN BY:  
FREEDOM SOLAR LLC

### REVISIONS

DESCRIPTION	DATE	REV
DESIGN PACKET	04/18/2023	

### CONTRACTOR

**FREEDOM<sup>™</sup>**  
**SOLAR POWER**  
FREEDOM SOLAR LLC  
4801 FREIDRICH LN, STE 100  
AUSTIN, TX 78744  
TECL # 28621  
TBPE FIRM # F-17690

### PROJECT NAME

ALLISON, DAVID PHASE II  
81 CHICORA CLUB DRIVE  
DUNN, NORTH CAROLINA,  
28334  
(910) 261-9553

### SHEET NAME

COVER

### SHEET SIZE

ANSI B  
11" x 17"

### SHEET NUMBER

PV-0



LEAD ID: 105880

**CONSTRUCTION SUMMARY**

- (50) (SUNPOWER SPR-M435-H-AC) SOLAR MODULES, 21.8 kW DC STC  
MODULE DIMENSIONS = 40.6" X 73.7" X 1.57"
- (50) SUNPOWER SPR-M435-H-AC [240V] PV INVERTERS  
COMBINED INVERTER OUTPUT = 19.2 kW AC.
- (387) (36 X 10.75') LINEAR FEET SUNPOWER INVISIMOUNT
- (132) QUICKBOLT QB2 ROOF ATTACHMENTS
- (1) SUNPOWER MONITORING
- (1) GENERATION PANEL
- (1) TESLA ENERGY GATEWAY-2
- (2) TESLA POWERWALL 2.0 BATTERY

**SITE DETAILS**

ROOF TYPE: ASPHALT SHINGLE  
ARRAY #1 - TILT = 39°, AZIMUTH = 148°

INSTALLATION DIFFICULTY = 14 => HARD

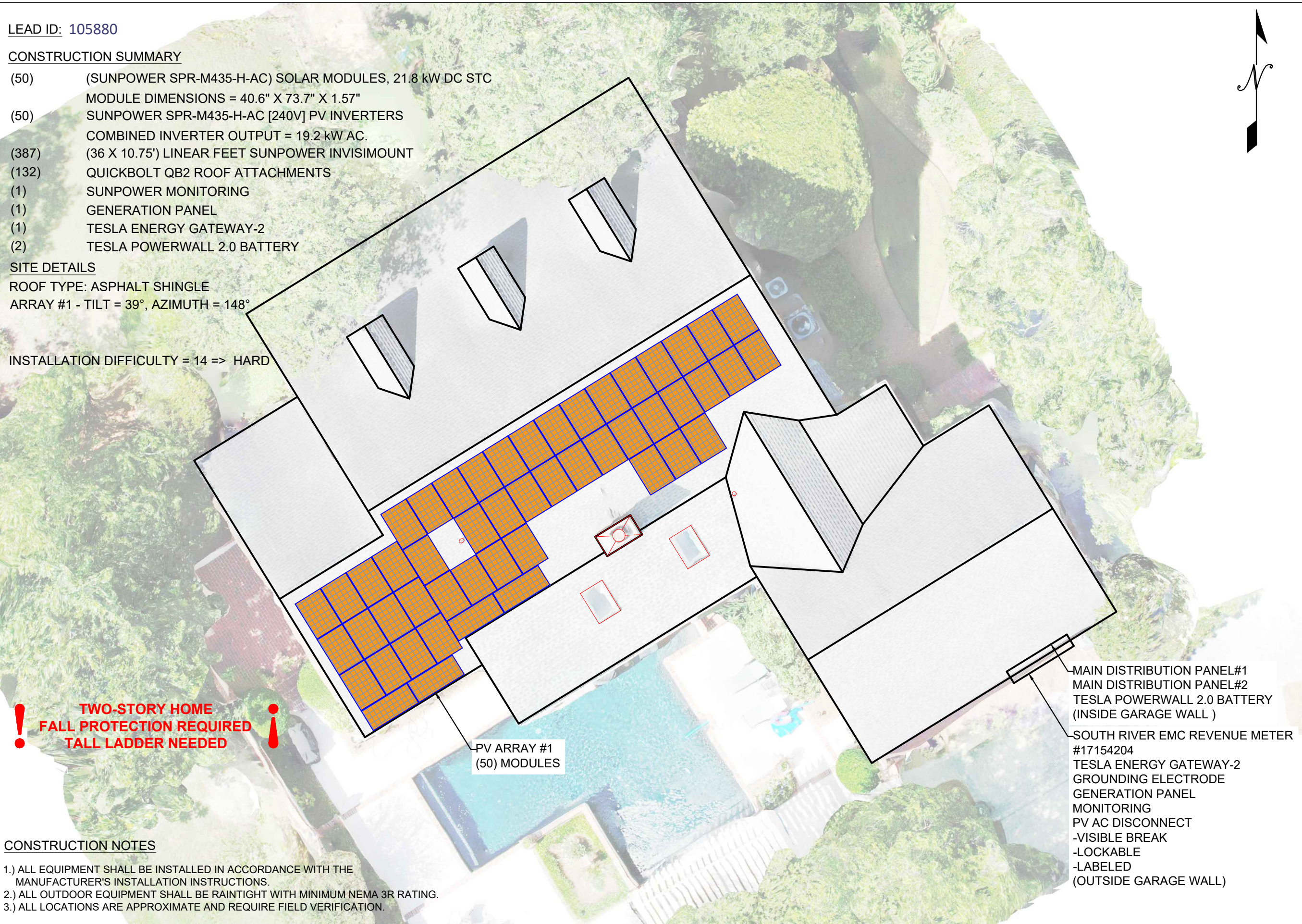

**! TWO-STORY HOME  
FALL PROTECTION REQUIRED  
TALL LADDER NEEDED !**

PV ARRAY #1  
(50) MODULES

- MAIN DISTRIBUTION PANEL#1
- MAIN DISTRIBUTION PANEL#2
- TESLA POWERWALL 2.0 BATTERY  
(INSIDE GARAGE WALL )
- SOUTH RIVER EMC REVENUE METER  
#17154204
- TESLA ENERGY GATEWAY-2
- GROUNDING ELECTRODE
- GENERATION PANEL
- MONITORING
- PV AC DISCONNECT
- VISIBLE BREAK
- LOCKABLE
- LABELED  
(OUTSIDE GARAGE WALL)

**CONSTRUCTION NOTES**

- 1.) ALL EQUIPMENT SHALL BE INSTALLED IN ACCORDANCE WITH THE MANUFACTURER'S INSTALLATION INSTRUCTIONS.
- 2.) ALL OUTDOOR EQUIPMENT SHALL BE RAIN-TIGHT WITH MINIMUM NEMA 3R RATING.
- 3.) ALL LOCATIONS ARE APPROXIMATE AND REQUIRE FIELD VERIFICATION.



DESIGN BY:  
FREEDOM SOLAR LLC

REVISIONS		
DESCRIPTION	DATE	REV
DESIGN PACKET	04/18/2023	

CONTRACTOR

**FREEDOM SOLAR POWER**

FREEDOM SOLAR LLC  
4801 FREIDRICH LN, STE 100  
AUSTIN, TX 78744  
TECL # 28621  
TBPE FIRM # F-17690

PROJECT NAME

**ALLISON, DAVID PHASE II**

**81 CHICORA CLUB DRIVE**

**DUNN, NORTH CAROLINA,**  
28334  
**(910) 261-9553**

SHEET NAME

**SITE MAP &  
PV LAYOUT**

SHEET SIZE

**ANSI B  
11" x 17"**

SHEET NUMBER

**PV-1**





DESIGN BY:  
FREEDOM SOLAR LLC

REVISIONS		
DESCRIPTION	DATE	REV
DESIGN PACKET	04/18/2023	

CONTRACTOR

**FREEDOM<sup>™</sup>  
SOLAR POWER**

FREEDOM SOLAR LLC  
4801 FREDRICH LN, STE 100  
AUSTIN, TX 78744  
TECL # 28621  
TBPE FIRM # F-17690

PROJECT NAME

ALLISON, DAVID PHASE II

81 CHICORA CLUB DRIVE

DUNN, NORTH CAROLINA,  
28334

(910) 261-9553

SHEET NAME

RACKING PLAN

SHEET SIZE

ANSI B  
11" x 17"

SHEET NUMBER

PV-1A

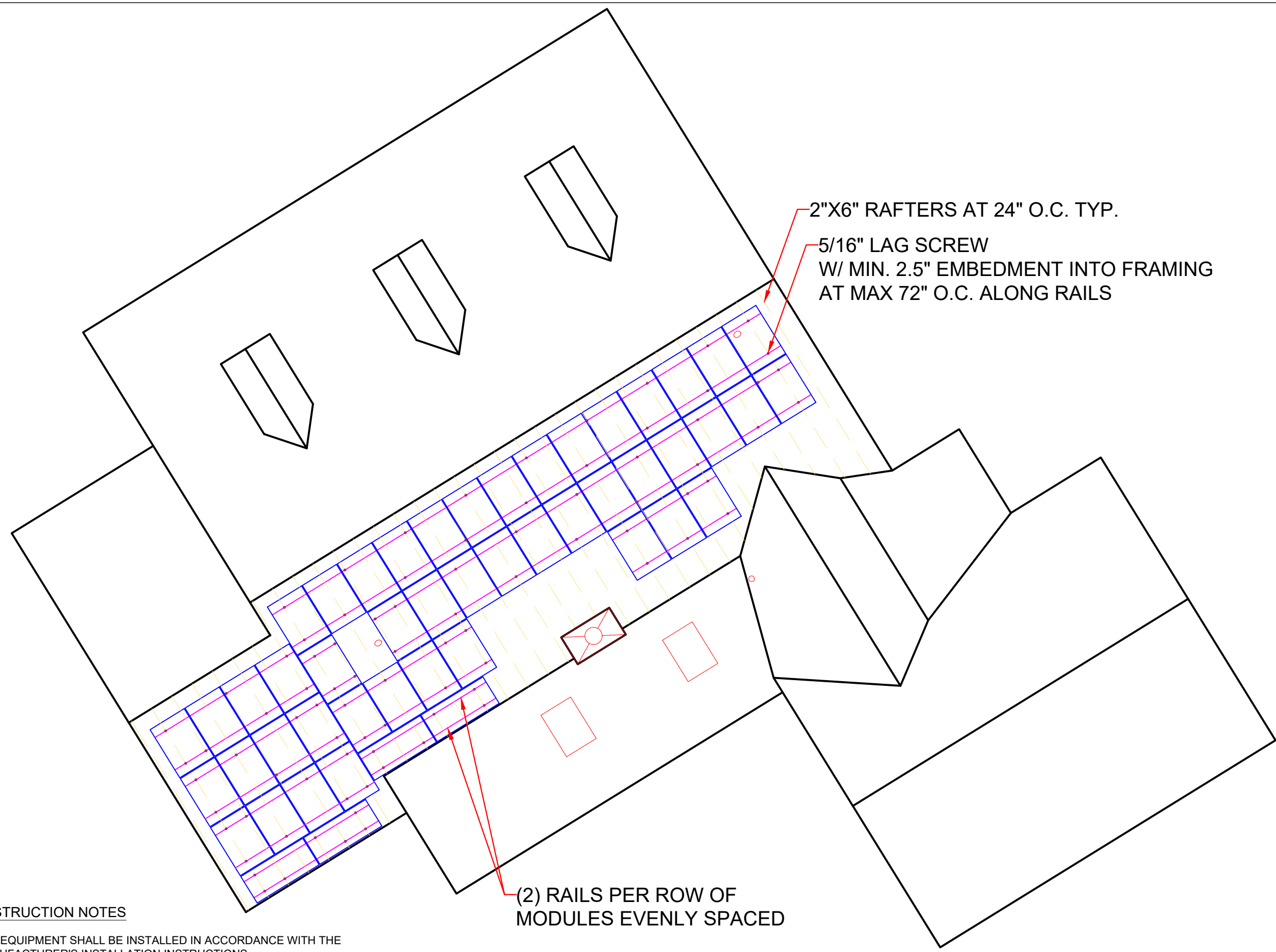

2"X6" RAFTERS AT 24" O.C. TYP.

5/16" LAG SCREW  
W/ MIN. 2.5" EMBEDMENT INTO FRAMING  
AT MAX 72" O.C. ALONG RAILS

(2) RAILS PER ROW OF  
MODULES EVENLY SPACED

**CONSTRUCTION NOTES**

- 1.) ALL EQUIPMENT SHALL BE INSTALLED IN ACCORDANCE WITH THE MANUFACTURER'S INSTALLATION INSTRUCTIONS.
- 2.) ALL OUTDOOR EQUIPMENT SHALL BE RAIN-TIGHT WITH MINIMUM NEMA 3R RATING.
- 3.) ALL LOCATIONS ARE APPROXIMATE AND REQUIRE FIELD VERIFICATION.

**SOLAR ARRAY - 21.8 kW DC STC**  
**(50) (SUNPOWER SPR-M435-H-G-AC) MODULES**

JUNCTION BOX:  
 TRANSITION FROM DG CABLE  
 TO AWG #10 THWN-2  
 NEMA 3R, UL LISTED

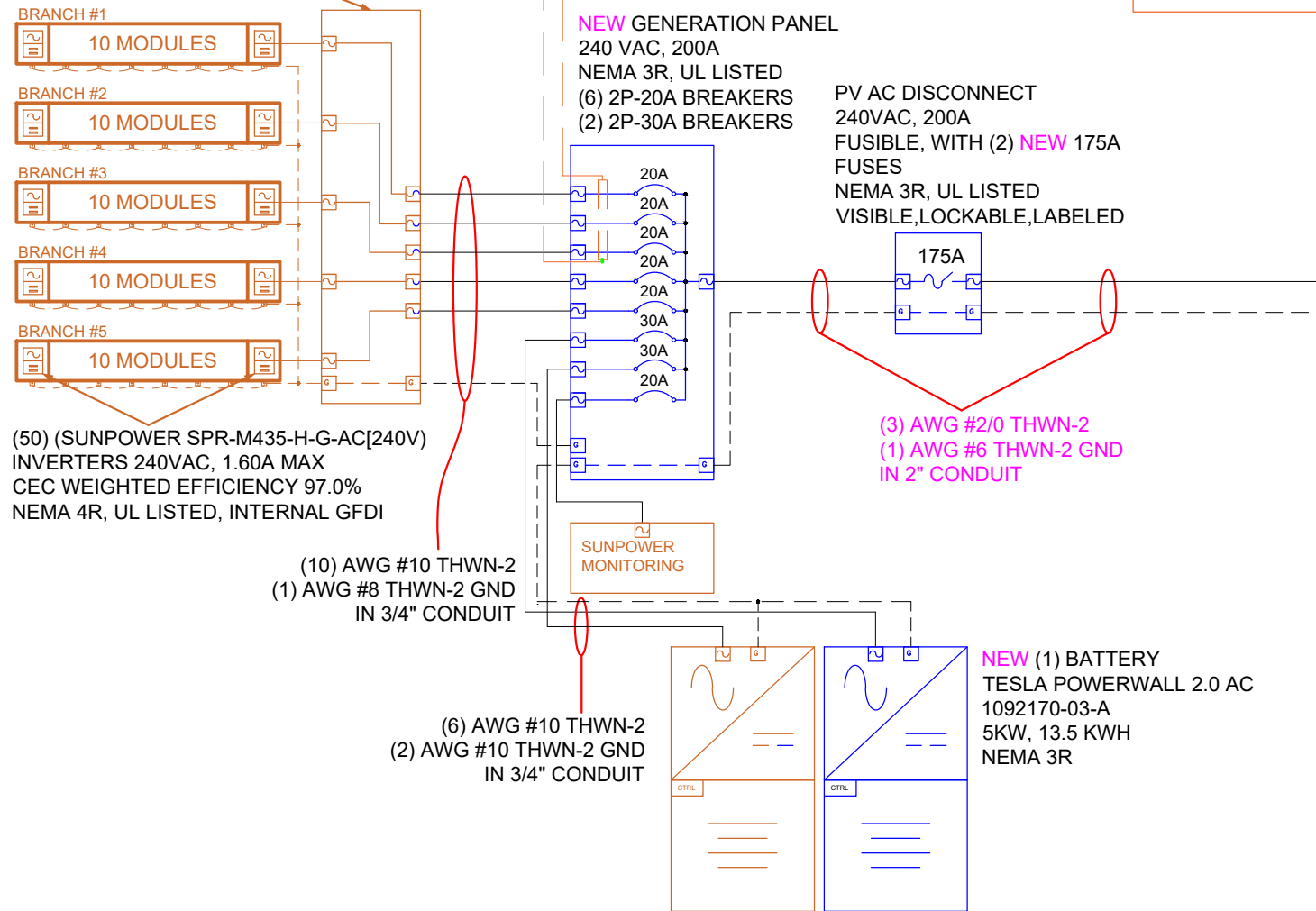

**ELECTRICAL NOTES**

- 1.) ALL EQUIPMENT TO BE LISTED BY UL OR OTHER NRTL, AND LABELED FOR ITS APPLICATION.
- 2.) ALL CONDUCTORS SHALL BE COPPER, RATED FOR 600 V AND 90°C WET ENVIRONMENT UNLESS OTHERWISE NOTED.
- 3.) WIRING, CONDUIT, AND RACEWAYS MOUNTED ON ROOFTOPS SHALL BE ROUTED DIRECTLY TO, AND LOCATED AS CLOSE AS POSSIBLE TO THE NEAREST RIDGE, HIP, OR VALLEY.
- 4.) WORKING CLEARANCES AROUND ALL NEW AND EXISTING ELECTRICAL EQUIPMENT SHALL COMPLY WITH NEC 110.26.
- 5.) DRAWINGS INDICATE THE GENERAL ARRANGEMENT OF SYSTEMS. CONTRACTOR SHALL FURNISH ALL NECESSARY OUTLETS, SUPPORTS, FITTINGS AND ACCESSORIES TO FULFILL APPLICABLE CODES AND STANDARDS.
- 6.) WHERE SIZES OF JUNCTION BOXES, RACEWAYS, AND CONDUITS ARE NOT SPECIFIED, THE CONTRACTOR SHALL SIZE THEM ACCORDINGLY.
- 7.) ALL WIRE TERMINATIONS SHALL BE APPROPRIATELY LABELED AND READILY VISIBLE.
- 8.) MAXIMUM MOUNTING HEIGHT FROM GRADE TO CENTER OF METER SOCKET SHALL BE 72" FOR RESIDENTIAL SINGLE PHASE METER SOCKETS 0-320 AMPS. MINIMUM MOUNTING HEIGHT IS 30" FROM FOR AUSTIN ENERGY, AND 48" FOR ALL OTHER JURISDICTIONS
- 9.) MINIMUM HORIZONTAL CLEARANCE FROM GAS REGULATOR TO ANY ELECTRICAL ENCLOSURE IS 36", EXCEPT AUSTIN ENERGY WHICH REQUIRES 48" CLEARANCE FROM GAS TO METER SOCKET
- 10.) PV DISCONNECT SHALL BE VISIBLE, LOCKABLE AND LABELED AND THE DOOR CANNOT BE OPENED WHEN HANDLE IS IN ON POSITION
- 11.) BY DEFAULT THE MONITORING DEVICE IS SHOWN CONNECTED TO A 20-AMP BREAKER IN THE SOLAR LOAD CENTER. ALTERNATIVELY, THE MONITORING DEVICE MAY BE CONNECTED TO A 20-AMP BREAKER AT THE MAIN DISTRIBUTION PANEL.
- 12.) ALL EQUIPMENT TERMINATIONS SHALL BE RATED FOR 75 DEGREES OR GREATER
- 13.) ALL CT WIRES SHALL BE CONSIDERED CLASS 1 PER NEC ARTICLE 725, AND BE MARKED AS RATED FOR 600V. PER 725.48(A) CLASS 1 CIRCUITS SHALL BE PERMITTED TO OCCUPY THE SAME RACEWAY AS OTHER CIRCUITS PROVIDED ALL CONDUCTORS ARE INSULATED FOR THE MAXIMUM VOLTAGE OF ANY CONDUCTOR IN THE RACEWAY.
- 14.) AWG #10 COPPER CONDUCTORS ARE SPECIFIED AS THE DEFAULT WIRE REQUIRED FROM THE PV ARRAY TO THE SOLAR LOAD CENTER, HOWEVER, AWG #12 COPPER CONDUCTORS MAY BE UTILIZED IF BOTH OF THE FOLLOWING CONDITIONS ARE MET: THE LENGTH OF THE CONDUCTOR IS LESS THAN 75 FT AND THERE ARE LESS THAN 8 CURRENT-CARRYING CONDUCTORS WITHIN THE RACEWAY.

**CALCULATIONS FOR CURRENT CARRYING CONDUCTORS**

**INVERTER OUTPUT WIRE AMPACITY CALCULATION**  
 [NEC 690.8(A)(3)]: 1.60A PER INVERTER (ENPHASE IQ7HS)  
 MAXIMUM INVERTER BRANCH CURRENT = (10)(1.60A) = 16A  
 CONTINUOUS USE:  
 #10 WIRE 75°C DERATED AMPACITY = (0.80)(35.0A) = 28A  
**28.0A > 16A**

**CONDITIONS OF USE:**  
 #10 WIRE 90°C DERATED AMPACITY = (0.91)(0.80)(40.0A) = 29.12A  
**29.12A > 16A**

**GENERATION PANEL OUTPUT WIRE AMPACITY CALCULATION**  
 [NEC 690.8(A)(3)]: 1.60A PER INVERTER (ENPHASE IQ7HS)  
 20.8A PER TESLA POWERWALL 2.0 BATTERY  
 COMBINED CURRENT = (50)(1.60A)+(2)20.8 = 121.7A  
 CONTINUOUS USE:  
 #2/0 WIRE 75°C DERATED AMPACITY = (0.80)(175A) = 140.0A  
**140A > 121.7A**

**CONDITIONS OF USE:**  
 #2/0 WIRE 90°C DERATED AMPACITY = (0.91)(195A) = 177.5A  
**177.5A > 121.7A**

**CALCULATIONS FOR OVERCURRENT DEVICES**

**INVERTER BRANCH AC CURRENT CALCULATION**  
 [NEC 690.8(A)(3)]: 1.60A PER INVERTER (ENPHASE IQ7HS)  
 MAXIMUM BRANCH INVERTER CURRENT = (10)(1.60A) = 16A  
 MINIMUM OCPD = (16A)(1.25) = 20A  
 USE (5) 2P-20A BREAKERS IN GENERATION PANEL FOR INVERTER BRANCH OCPD

**SYSTEM AC CURRENT CALCULATION**  
 [NEC 690.8(A)(3)]: 1.60A PER INVERTER (ENPHASE IQ7HS)  
 20.8A PER TESLA POWERWALL 2.0 BATTERY  
 COMBINED CURRENT = (50)(1.60A)+(2)20.8 = 121.7A  
 MINIMUM OCPD = (121.7A)(1.25) = 152.1A  
 USE (2) 160A FUSES IN PV AC DISCONNECT FOR SYSTEM OCPD  
**NOTE : AWG #2/0 CONDUCTORS ARE ADEQUATELY PROTECTED BY 175A FUSES**

**TESLA POWERWALL OUTPUT CURRENT CALCULATION**

**TESLA POWERWALL OUTPUT CURRENT CALCULATION**  
 20.8A PER TESLA POWERWALL 2.0 BATTERY INVERTER  
 COMBINED CURRENT = (2)(20.8) = 41.6A  
 MINIMUM OCPD = (41.6A)(1.25) = 52.0A  
 USE (2) 2P-30A BREAKER IN GENERATION PANEL FOR (2) POWERWALL OCPD

DESIGN BY:  
 FREEDOM SOLAR LLC

REVISIONS		
DESCRIPTION	DATE	REV
DESIGN PACKET	04/18/2023	

CONTRACTOR

**FREEDOM™  
 SOLAR POWER**

FREEDOM SOLAR LLC  
 4801 FREIDRICH LN, STE 100  
 AUSTIN, TX 78744  
 TECL # 28621  
 TBPE FIRM # F-17690

PROJECT NAME

**ALLISON, DAVID PHASE II**  
**81 CHICORA CLUB DRIVE**  
**DUNN, NORTH CAROLINA,**  
**28334**  
**(910) 261-9553**

SHEET NAME

**ELECTRICAL  
 DIAGRAM**

SHEET SIZE

**ANSI B  
 11" x 17"**

SHEET NUMBER

**PV-3**

DESIGN BY:  
FREEDOM SOLAR LLC

REVISIONS		
DESCRIPTION	DATE	REV
DESIGN PACKET	04/18/2023	

CONTRACTOR



**FREEDOM**  
SOLAR POWER

FREEDOM SOLAR LLC  
4801 FREIDRICH LN, STE 100  
AUSTIN, TX 78744  
TECL # 28621  
TBPE FIRM # F-17690

PROJECT NAME

**ALLISON, DAVID PHASE II**  
**81 CHICORA CLUB DRIVE**  
**DUNN, NORTH CAROLINA,**  
**28334**  
**(910) 261-9553**

SHEET NAME

**EQ.WALL & MOUNTING DETAIL**

SHEET SIZE

**ANSI B**  
**11" x 17"**

SHEET NUMBER

**PV-4**

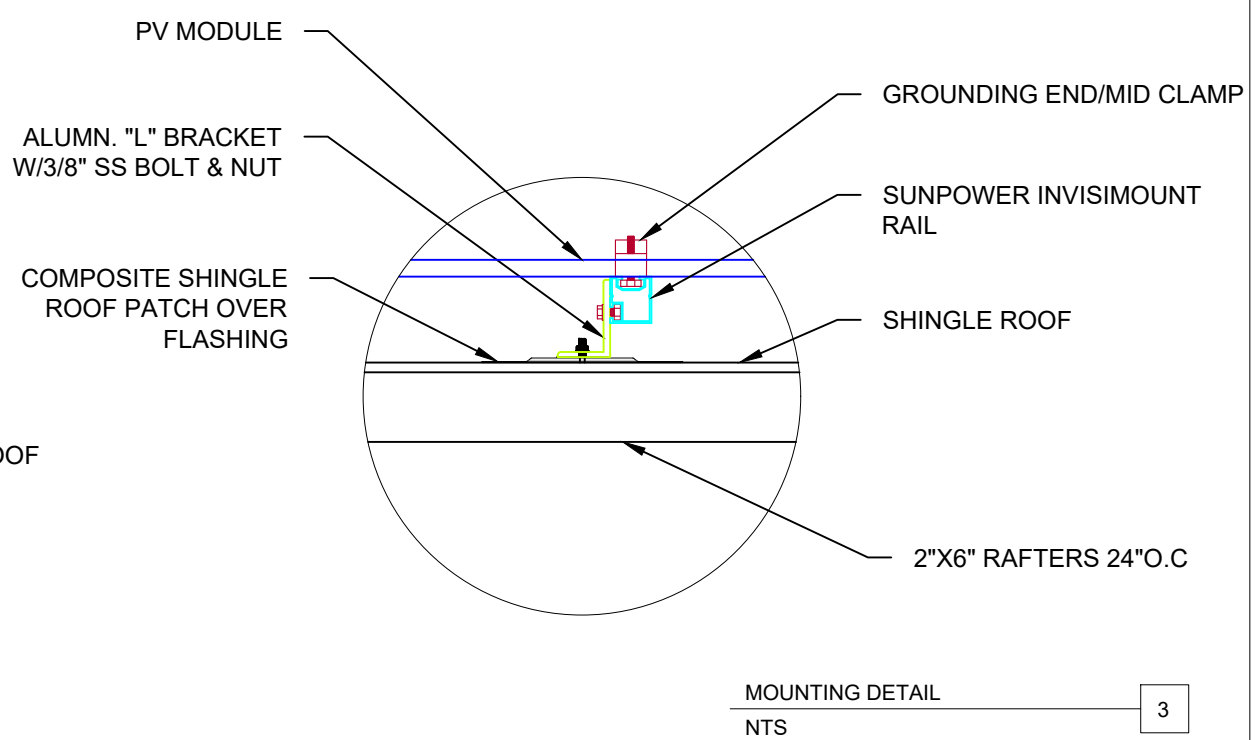
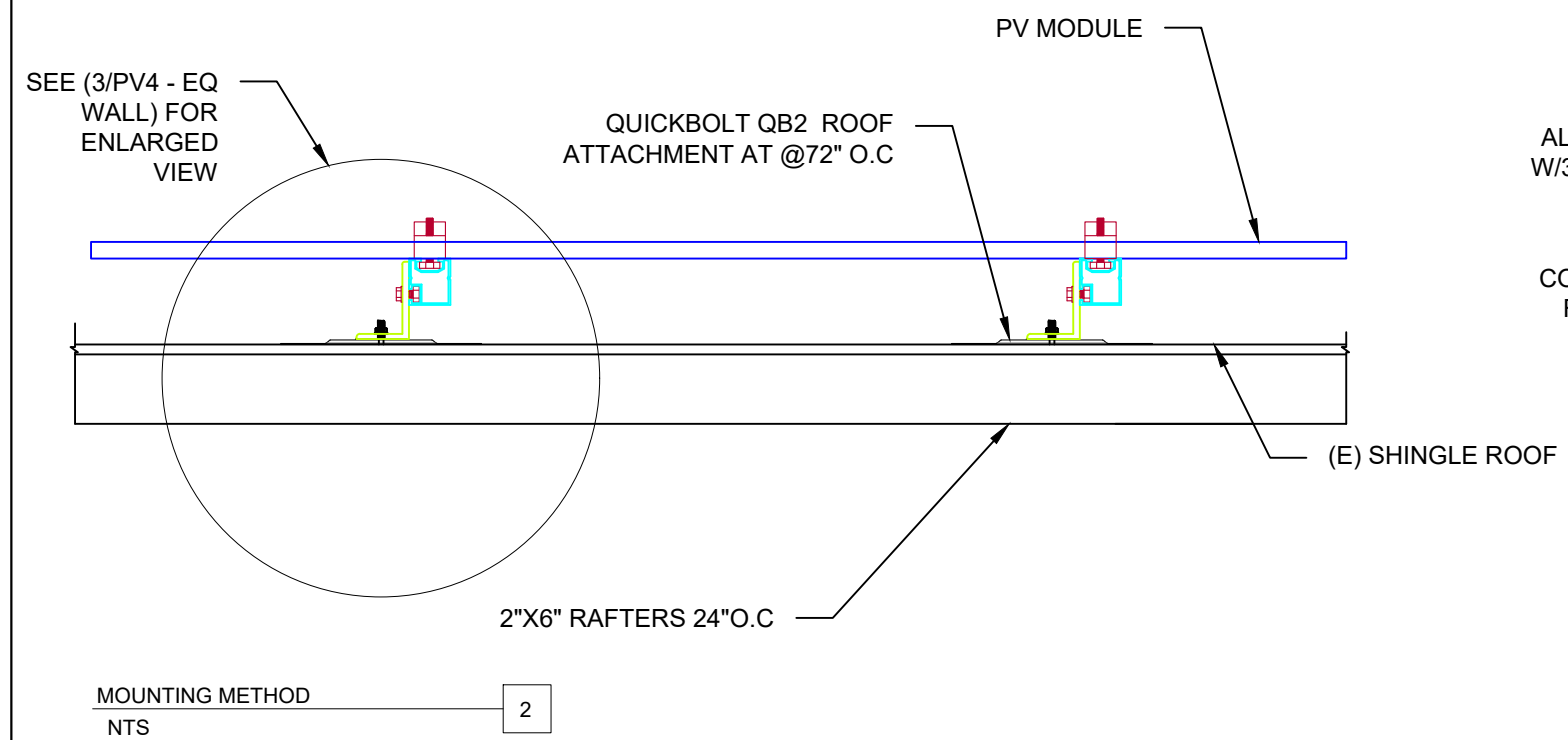
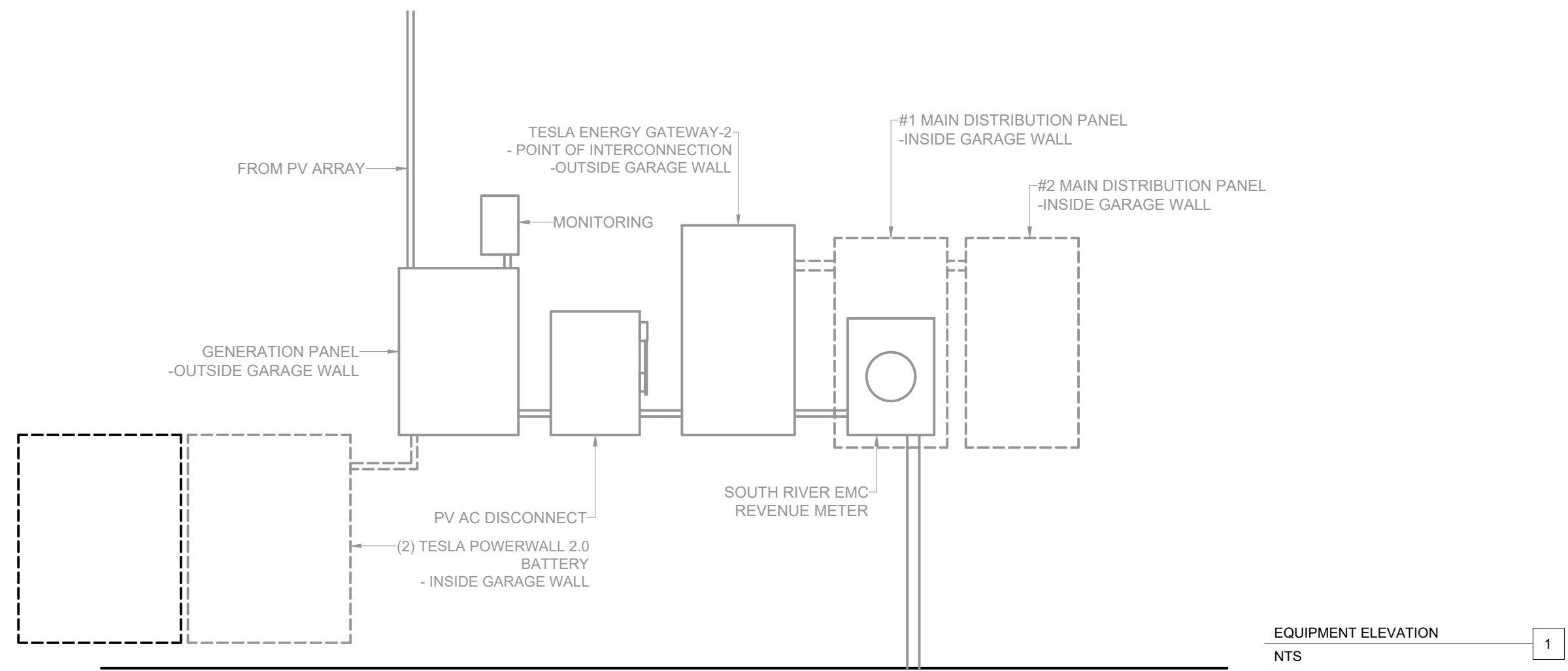

NOTE: NOT ALL LABELS MAY BE APPLICABLE

**SIGNAGE REQUIREMENTS**

- > RED BACKGROUND
- > WHITE LETTERING
- > MIN. 3/8" LETTER HEIGHT
- > ALL CAPITAL LETTERS
- > ARIAL OR SIMILAR FONT
- > REFLECTIVE, WEATHER RESISTANT MATERIAL, UL 969

**PV SYSTEM DISCONNECT**

REQ'D BY: NEC 690.13(B)

A

APPLY TO:  
PV DISCONNECT

**WARNING**  
ELECTRIC SHOCK HAZARD.  
DO NOT TOUCH TERMINALS.  
TERMINALS ON THE LINE AND  
LOAD SIDES MAY BE  
ENERGIZED IN THE OPEN  
POSITION.

REQ'D BY: NEC 690.13(B)

B

APPLY TO:  
PV DISCONNECT

**WARNING: PHOTOVOLTAIC  
POWER SOURCE**

REQ'D BY: NEC 690.31(G)(3)

C

APPLY TO:  
RACEWAYS, CABLE TRAYS,  
OTHER WIRING METHODS, AND  
ENCLOSURES THAN CONTAIN  
PV SYSTEM DC CONDUCTORS

**WARNING**  
POWER SOURCE OUTPUT  
CONNECTION. DO NOT  
RELOCATE THIS  
OVERCURRENT DEVICE

REQ'D BY: NEC 705.12(B)(2)(3)(b)

D

APPLY TO:  
DISTRIBUTION EQUIPMENT  
ADJACENT TO BACK-FED BREAKER

**2" ADDRESS NUMBERS**

REQ' BY: AHJ

E

APPLY TO:  
REVENUE METER SOCKET  
(IF APPLICABLE)

**REVENUE METER**

REQ'D BY: AHJ

F

APPLY TO:  
REVENUE METER SOCKET  
(IF APPLICABLE)

**MONITORING**

REQ'D BY: FREEDOM SOLAR

G

APPLY TO:  
MONITORING DEVICE ENCLOSURE

**PHOTOVOLTAIC SYSTEM  
AC DISCONNECT**  
OPERATING CURRENT: 100.8 A  
OPERATING VOLTAGE: 240 VAC

REQ'D BY: 690.56(1)(a)

H

APPLY TO:  
PV DISCONNECT

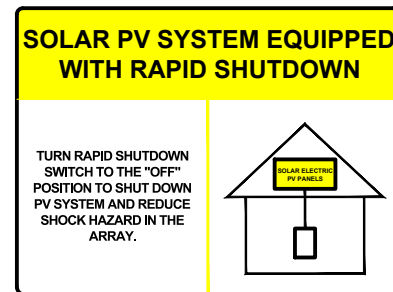

REQ'D BY: FREEDOM SOLAR

I

APPLY TO:  
MAIN DISTRIBUTION PANEL

**CAUTION**  
POWER TO THIS BUILDING IS ALSO SUPPLIED FROM THE  
FOLLOWING SOURCES WITH DISCONNECTS AS SHOWN:

UTILITY SUPPLY & CUSTOMER  
SERVICE PANEL

PV AC DISCONNECT

RAPID SHUTDOWN SWITCH

FRONT

REQ'D BY: 705.10

J

APPLY TO:  
MAIN DISTRIBUTION PANEL  
(\*ONLY REQUIRED IF PV SYSTEM  
DISCONNECT IS NOT GROUPED  
WITH MAIN SERVICE DISCONNECT)  
**SEE SHEET PV-6 FOR SITE  
SPECIFIC LABELS**

DESIGN BY:  
FREEDOM SOLAR LLC

REVISIONS		
DESCRIPTION	DATE	REV
DESIGN PACKET	04/18/2023	

CONTRACTOR

**FREEDOM<sup>SM</sup>  
SOLAR POWER**

FREEDOM SOLAR LLC  
4801 FREIDRICH LN, STE 100  
AUSTIN, TX 78744  
TECL # 28621  
TBPE FIRM # F-17690

PROJECT NAME

ALLISON, DAVID PHASE II

81 CHICORA CLUB DRIVE

DUNN, NORTH CAROLINA,  
28334

(910) 261-9553

SHEET NAME

SYSTEM LABELING  
DETAIL

SHEET SIZE

ANSI B  
11" x 17"

SHEET NUMBER

PV-5

**CAUTION:**  
**MULTIPLE SOURCES OF POWER**  
**LOCATION OF EACH POWER SOURCE**  
**DISCONNECTING MEANS SHOWN BELOW**

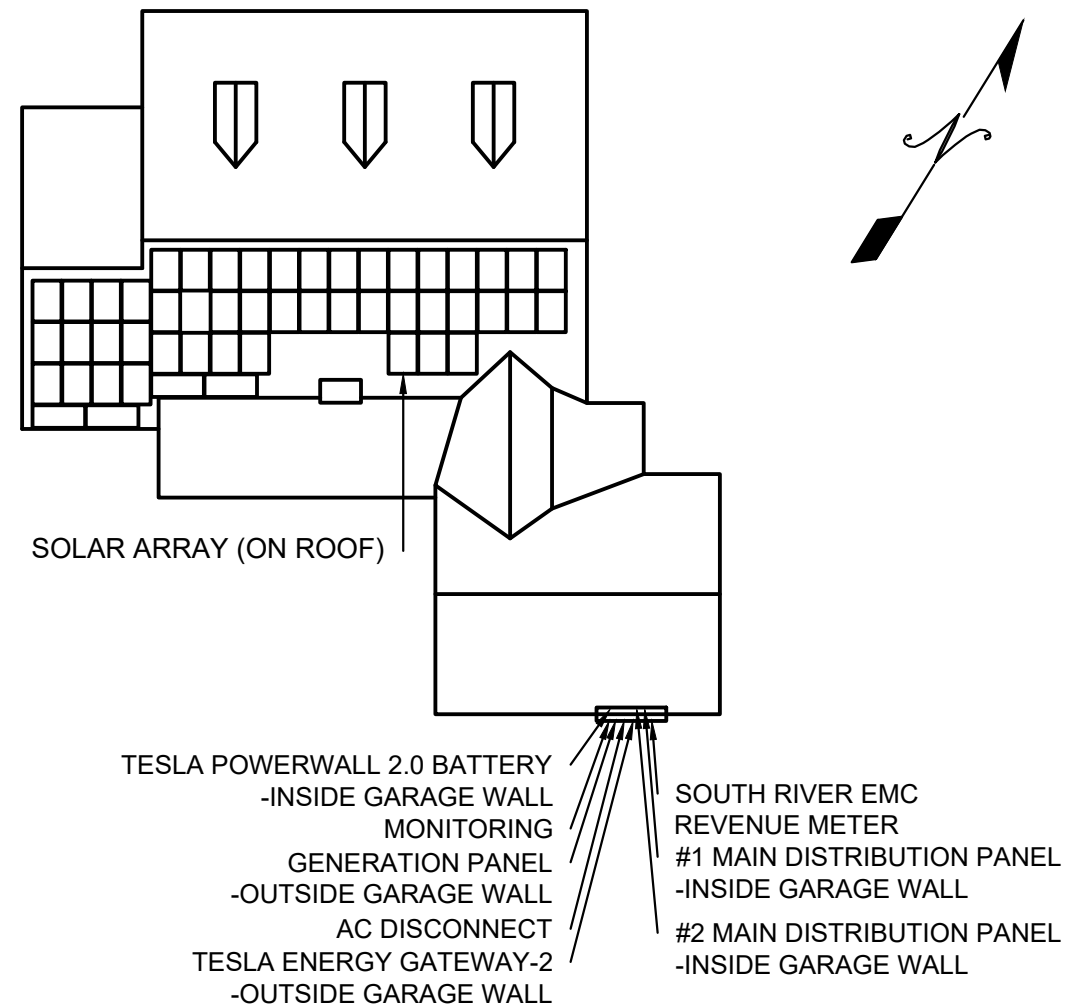

QUESTIONS, CALL:  
 800-504-2337  
[www.freedom solarpower.com](http://www.freedom solarpower.com)



81 CHICORA CLUB DRIVE  
 PROJECT ID:105880

DESIGN BY:  
 FREEDOM SOLAR LLC

REVISIONS		
DESCRIPTION	DATE	REV
DESIGN PACKET	04/18/2023	

CONTRACTOR



**FREEDOM™  
 SOLAR POWER**

FREEDOM SOLAR LLC  
 4801 FREDRICH LN, STE 100  
 AUSTIN, TX 78744  
 TECL # 28621  
 TBPE FIRM # F-17690

PROJECT NAME

ALLISON, DAVID PHASE II  
 81 CHICORA CLUB DRIVE  
 DUNN, NORTH CAROLINA,  
 28334  
 (910) 261-9553

SHEET NAME

SITE  
 DIRECTORY  
 PLACARD

SHEET SIZE

ANSI B  
 11" x 17"

SHEET NUMBER

PV-6



USE THE SAFETY SYMBOL KEY TO DRAW IN THE CONTROLLED ACCESS ZONE (CAZ), LADDER PLACEMENT, METER LOCATION, FALL PROTECTION ANCHOR POINT, AND ANY OTHER HAZARD.

HARD HAT IS REQUIRED AT ALL TIMES IN CAZ

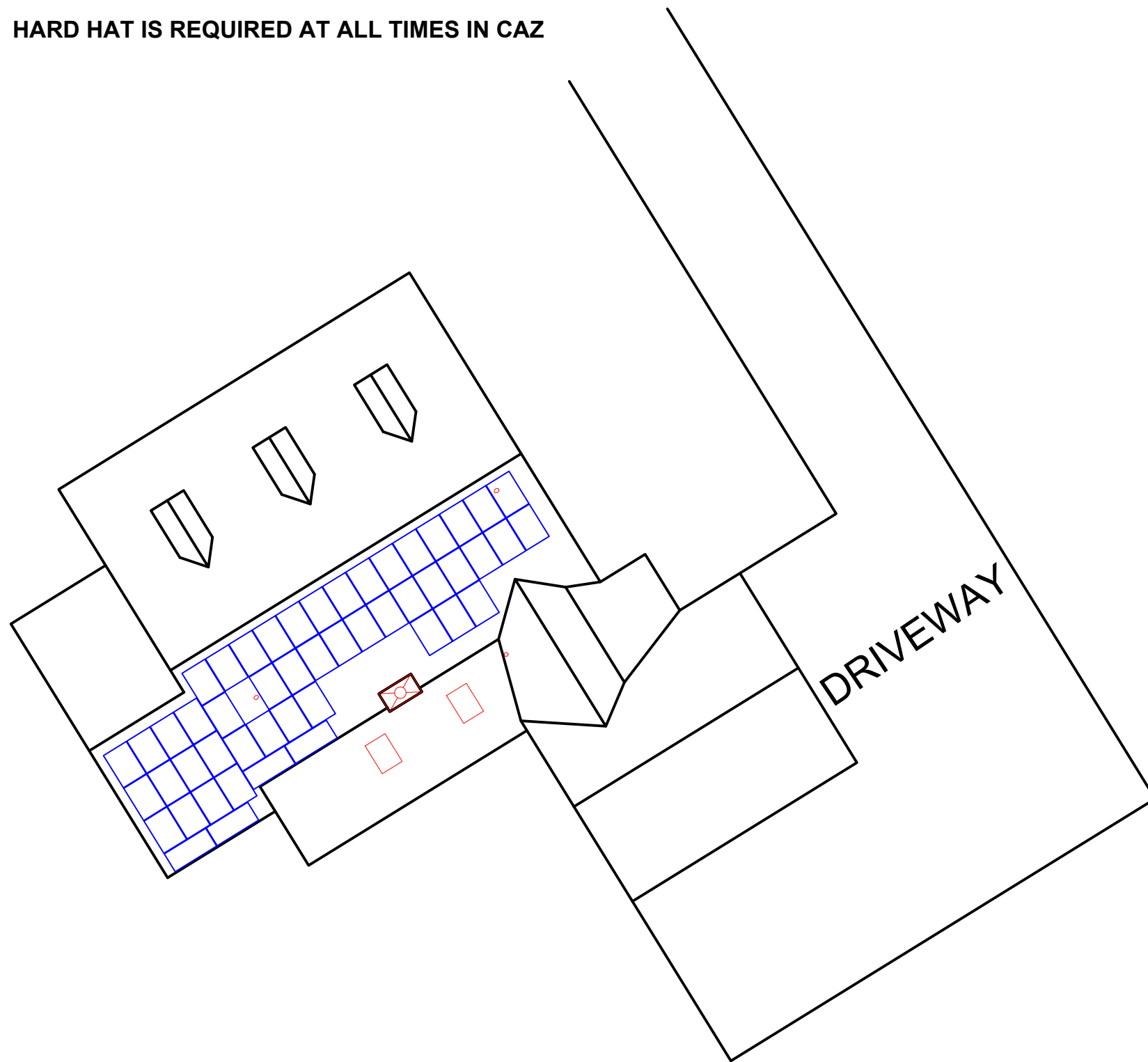

**SAFETY SYMBOL KEY**

- CAZ
- L** LADDER
- M** METER
- ==== POWER LINES
- R** RESTRAINT ANCHOR
- A** ARREST ANCHOR



DESIGN BY:  
FREEDOM SOLAR LLC

REVISIONS		
DESCRIPTION	DATE	REV
DESIGN PACKET	04/18/2023	

CONTRACTOR

**FREEDOM<sup>TM</sup>  
SOLAR POWER**

FREEDOM SOLAR LLC  
4801 FREIDRICH LN, STE 100  
AUSTIN, TX 78744  
TECL # 28621  
TBPE FIRM # F-17690

PROJECT NAME

ALLISON, DAVID PHASE II

81 CHICORA CLUB DRIVE

DUNN, NORTH CAROLINA,  
28334

(910) 261-9553

SHEET NAME

SAFETY PLAN

SHEET SIZE

ANSI B  
11" x 17"

SHEET NUMBER

PV-7

CONDUCT SAFETY MEETING WITH ALL CREW MEMBERS ON SITE AT THE BEGINNING OF EACH JOB. USE SIGN IN SHEET BELOW.

1. \_\_\_\_\_
2. \_\_\_\_\_
3. \_\_\_\_\_
4. \_\_\_\_\_
5. \_\_\_\_\_

GUEST SIGN IN

1. \_\_\_\_\_
2. \_\_\_\_\_
3. \_\_\_\_\_

COMPETENT PERSON: \_\_\_\_\_ JOB START DATE: \_\_\_\_\_





# SUNPOWER®

## M-Series: M440 | M435 | M430 | M425 | M420 SunPower® Residential AC Module

### 420-440W Residential AC Module

#### SunPower® Maxeon® Technology

Built specifically for use with the SunPower Equinox® system, the only fully integrated solar solution designed, engineered, and warranted by one company.



#### Highest Power AC Density Available.

The patented, solid-copper foundation Maxeon Gen 6 cell is over 5% larger than prior generations, delivering the highest efficiency AC solar panel available.<sup>1</sup>

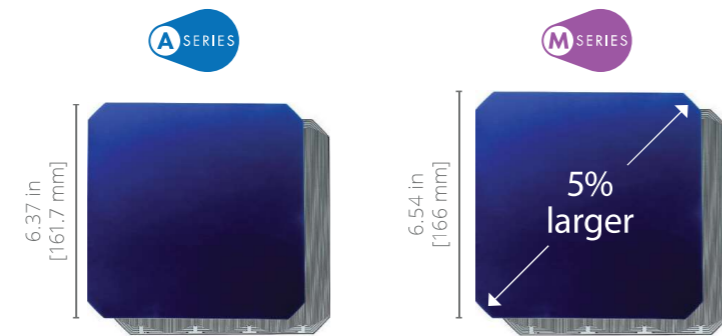

#### Highest Lifetime Energy and Savings

Designed to deliver 60% more energy over 25 years in real-world conditions like partial shade and high temperatures.<sup>2</sup>

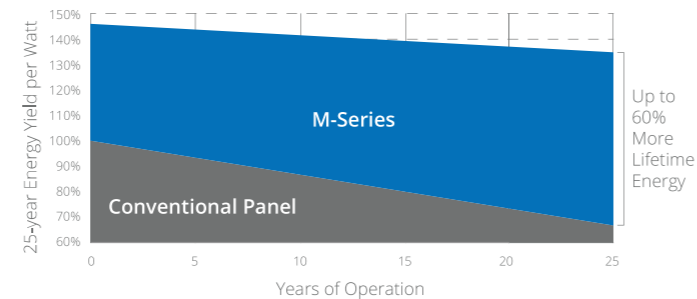

#### Best Reliability, Best Warranty

With more than 42.6 million and 15 GW modules deployed around the world, SunPower technology is proven to last. That's why we stand behind our module and microinverter with the industry's best 25-year Combined Power and Product Warranty.

#### Part of the SunPower Equinox® Solar System

- Compatible with mySunPower™ monitoring
- Seamless aesthetics



#### Factory-integrated Microinverter

- Highest-power integrated AC module in solar
- Engineered and calibrated by SunPower for SunPower AC modules

AC Electrical Data		
Inverter Model: Type H (Enphase IQ7HS)	@240 VAC	@208 VAC
Max. Continuous Output Power (VA)	384	369
Nom. (L-L) Voltage/Range <sup>3</sup> (V)	240 / 211-264	208 / 183-229
Max. Continuous Output Current (Arms)	1.60	1.77
Max. Units per 20 A (L-L) Branch Circuit <sup>4</sup>	10	9
CEC Weighted Efficiency	97.0%	96.5%
Nom. Frequency	60 Hz	
Extended Frequency Range	47-68 Hz	
AC Short Circuit Fault Current Over 3 Cycles	4.82 A rms	
Overvoltage Class AC Port	III	
AC Port Backfeed Current	18 mA	
Power Factor Setting	1.0	
Power Factor (adjustable)	0.85 (inductive) / 0.85 (capacitive)	

DC Power Data					
	SPR-M440-H-AC	SPR-M435-H-AC	SPR-M430-H-AC	SPR-M425-H-AC	SPR-M420-H-AC
Nom. Power <sup>6</sup> (P <sub>nom</sub> ) W	440	435	430	425	420
Power Tolerance	+5/-0%				
Module Efficiency	22.8%	22.5%	22.3%	22.0%	21.7%
Temp. Coef. (Power)	-0.29% / °C				
Shade Tolerance	Integrated module-level max. power point tracking				

Tested Operating Conditions	
Operating Temp.	-40° F to +185°F (-40°C to +85°C)
Max. Ambient Temp.	122°F (50°C)
Max. Test Load <sup>8</sup>	Wind: 125 psf, 6000 Pa, 611 kg/m <sup>2</sup> back Snow: 187 psf, 9000 Pa, 917 kg/m <sup>2</sup> front
Max. Design Load	Wind: 75 psf, 3600 Pa, 367 kg/m <sup>2</sup> back Snow: 125 psf, 6000 Pa, 611 kg/m <sup>2</sup> front
Impact Resistance	1 inch (25 mm) diameter hail at 52 mph (23 m/s)

Mechanical Data	
Solar Cells	66 Maxeon Gen 6
Front Glass	High-transmission tempered glass with anti-reflective coating
Environmental Rating	Outdoor rated
Frame	Class 1 black anodized (highest AAMA rating)
Weight	48 lb (21.8 kg)
Recommended Max. Module Spacing	1.3 in. (33 mm)

1 Based on datasheet review of websites of top 20 manufacturers per Wood Mackenzie US PV Leaderboard Q3 2021.  
2 Maxeon 435 W, 22.5% efficient, compared to a Conventional Panel on same-sized arrays (260 W, 16% efficient, approx. 1.6 m<sup>2</sup>), 7.9% more energy per watt (based on PVSyst pan files for avg. US climate), 0.5%/yr slower degradation rate (Jordan, et. al. "Robust PV Degradation Methodology and Application," PVSC 2018).  
3 Voltage range can be extended beyond nominal if required by the utility.  
4 Limits may vary. Refer to local requirements to define the number of microinverters per branch in your area.  
5 Factory set to IEEE 1547a-2014 default settings. CA Rule 21 default settings profile set during commissioning.  
6 Standard Test Conditions (1000 W/m<sup>2</sup> irradiance, AM 1.5, 25°C). All DC voltage is fully contained within the module.  
7 UL Listed as PVRSE and conforms with NEC 2014 and NEC 2017 690.12; and C22.1-2015 Rule 64-218 Rapid Shutdown of PV Systems, for AC and DC conductors; when installed according to manufacturer's instructions.  
8 Please read the safety and installation instructions for more information regarding load ratings and mounting configurations.

See [www.sunpower.com/company](http://www.sunpower.com/company) for more reference information. Specifications included in this datasheet are subject to change without notice.

©2022 SunPower Corporation. All rights reserved. SUNPOWER, the SUNPOWER logo, EQUINOX and MYSUNPOWER are trademarks or registered trademarks of SunPower Corporation in the U.S. MAXEON is a registered trademark of Maxeon Solar Technologies, Ltd. For more information visit [www.maxeon.com/legal](http://www.maxeon.com/legal).

Warranties, Certifications, and Compliance	
Warranties	<ul style="list-style-type: none"> <li>• 25-year limited power warranty</li> <li>• 25-year limited product warranty</li> </ul>
Certifications and Compliance	<ul style="list-style-type: none"> <li>• UL 1741 / IEEE-1547</li> <li>• UL 1741 AC Module (Type 2 fire rated)</li> <li>• UL 61730</li> <li>• UL 62109-1 / IEC 62109-2</li> <li>• FCC Part 15 Class B</li> <li>• ICES-0003 Class B</li> <li>• CAN/CSA-C22.2 NO. 107.1-01</li> <li>• CA Rule 21 (UL 1741 SA)<sup>5</sup></li> <li>• (includes Volt/Var and Reactive Power Priority)</li> <li>• UL Listed PV Rapid Shutdown Equipment<sup>7</sup></li> </ul> <p>Enables installation in accordance with:</p> <ul style="list-style-type: none"> <li>• NEC 690.6 (AC module)</li> <li>• NEC 690.12 Rapid Shutdown (inside and outside the array)</li> <li>• NEC 690.15 AC Connectors, 690.33(A)-(E)(1)</li> </ul> <p>When used with AC module Q Cables and accessories (UL 6703 and UL 2238):</p> <ul style="list-style-type: none"> <li>• Rated for load breaker disconnect</li> </ul>
PID Test	1000 V; IEC 62804

Packaging Configuration	
Modules per pallet	25
Packaging box dimensions	75.4 × 42.2 × 48.0 in. (1915 × 1072 × 1220 mm)
Pallet gross weight	1300.7 lb (590 kg)
Pallets per container	32
Net weight per container	41,623 lb (18,880 kg)

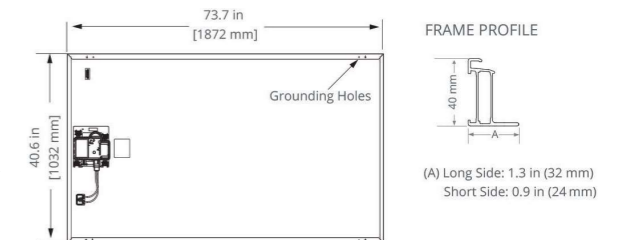

Please read the safety and installation instructions for details.

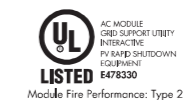

539973 RevB  
January 2022



# SunPower® EnergyLink™ | Residential and Commercial PVS6

## Improve Support, Reduce Maintenance Costs

An intuitive monitoring website enables you to:

- See a visual map of customer sites
- Remotely manage hundreds of sites
- Receive elective system reports
- Locate system issues and remotely diagnose
- Diagnose issues online
- Drill down for the status of individual devices

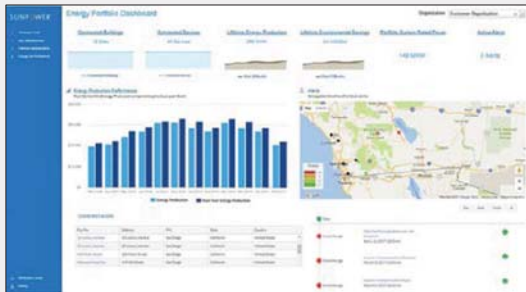

## Add Value for Customers

With the SunPower Monitoring System customers can:

- See what their solar system produces each day, month, or year
- Optimize their solar investment and save on energy expenses
- See their energy use and estimated bill savings
- See their solar system's performance using the SunPower monitoring website or mobile app



## SunPower EnergyLink—Plug-and-Play Installation

This complete solution for residential and commercial monitoring and control includes the SunPower® PV Supervisor 6 (PVS6) which improves the installation process, overall system reliability, and customer experience.

- Compact footprint for improved aesthetics
- Robust cloud connectivity and comprehensive local connectivity
- Flexible configuration of devices during installation
- Consumption metering
- Revenue-grade production metering (pending)
- Web-based commissioning
- Remote diagnostics of PVS6 and inverters
- Durable UL Type 3R enclosure reduces maintenance costs
- Easy integration with SunPower eBOS



## Robust Cloud Connectivity

Multiple options to maintain optimal connectivity:

- Hardwired Ethernet
- Wi-Fi
- Cellular backup



# SunPower® EnergyLink™ | Residential and Commercial PVS6

SunPower Monitoring Websites

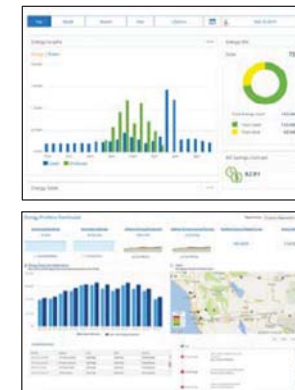

PVS6



SunPower AC Modules

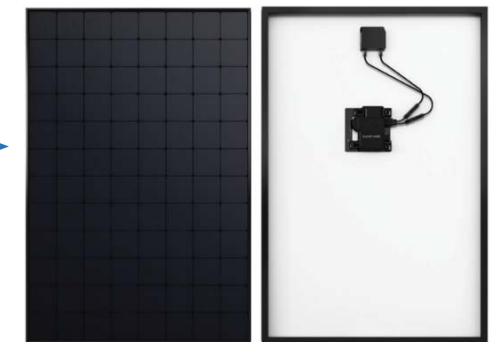

Multiple communication options include Ethernet, Wi-Fi, and cellular.

Site Requirements	
Number of SunPower AC modules supported per PVS6	85
Internet access	High-speed internet access via accessible router or switch
Power	<ul style="list-style-type: none"> <li>• 100–240 VAC (L–N), 50 or 60 Hz</li> <li>• 208 VAC (L–L in 3-phase), 60 Hz</li> </ul>

Operating Conditions	
Temperature	–22°F to +140°F (–30°C to +60°C)
Humidity (maximum)	95%, non-condensing

Mechanical	
Weight	5.5 lbs (2.5 kg)
Dimensions	11.8 × 8.0 × 4.2 in. (30.5 × 20.5 × 10.8 cm)
Enclosure rating	UL50E Type 3R

Communication	
RS-485	Inverters and meters
Integrated Metering	<ul style="list-style-type: none"> <li>• One channel of revenue-grade production metering</li> <li>• Two channels of consumption metering</li> </ul>
Ethernet	1 LAN (or optional WAN) port
PLC	PLC for SunPower AC modules
Wi-Fi	802.11b/g/n 2.4 GHz and 5 GHz
Cellular	LTE Cat-M1/3G UMTS
ZigBee	IEEE 802.15.4 MAC, 2.4GHz ISM band
Data Storage	60 days
Upgrades	Automatic firmware upgrades

Web and Mobile Device Support	
Customer site	<a href="http://monitor.us.sunpower.com">monitor.us.sunpower.com</a>
Partner site	<a href="http://pvsmgmt.us.sunpower.com">pvsmgmt.us.sunpower.com</a>
Browsers	Firefox, Safari, and Chrome
Mobile devices	iPhone®, iPad®, and Android™
Customer app	<ol style="list-style-type: none"> <li>1. Create account online at: <a href="http://monitor.us.sunpower.com">monitor.us.sunpower.com</a>.</li> <li>2. On a mobile device, download the SunPower Monitoring app from Apple App Store™ or Google Play™ store.</li> <li>3. Sign in using account email and password.</li> </ol>

Warranty and Certifications	
Warranty	10-year Limited Warranty
Certifications	UL, cUL, CE, UL 61010-1 and -2, FCC Part 15 (Class B)



© 2019 SunPower Corporation. All rights reserved. SUNPOWER, SUNPOWER logo, and ENERGYLINK are trademarks or registered trademarks of SunPower Corporation. iPhone and iPad are registered trademarks of Apple Inc. Android and Google Play are trademarks of Google Inc. All other trademarks are the property of their respective owners. Specifications included in this datasheet are subject to change without notice.

530536 RevC







## SunPower® InvisiMount™ | Residential Mounting System

### Simple and Fast Installation

- Integrated module-to-rail grounding
- Pre-assembled mid and end clamps
- Levitating mid clamp for easy placement
- Mid clamp width facilitates consistent, even module spacing
- UL 2703 Listed integrated grounding

### Flexible Design

- Addresses nearly all sloped residential roofs
- Design in landscape and portrait with up to 8' rail span
- Pre-drilled rails and rail splice
- Rails enable easy obstacle management

### Customer-Preferred Aesthetics

- #1 module and #1 mounting aesthetics
- Best-in-class system aesthetics
- Premium, low-profile design
- Black anodized components
- Hidden mid clamps and capped, flush end clamps

### Part of Superior System

- Built for use with SunPower DC and AC modules
- Best-in-class system reliability and aesthetics
- Optional rooftop transition flashing, rail-mounted J-box, and wire management rail clips
- Combine with SunPower modules and SunPower EnergyLink® monitoring app



### Elegant Simplicity

SunPower® InvisiMount™ is a SunPower-designed rail-based mounting system. The InvisiMount system addresses residential sloped roofs and combines faster installation time, design flexibility, and superior aesthetics. The InvisiMount product was specifically envisioned and engineered to pair with SunPower modules. The resulting system-level approach amplifies the aesthetic and installation benefits—for homeowners and for installers.

sunpower.com



## SunPower® InvisiMount™ | Residential Mounting System

### InvisiMount Components



InvisiMount Component Details		
Mid clamp	Black oxide stainless steel 300 series	63 g (2.2 oz)
End clamp	Black anodized aluminum 6000 series	110 g (3.88 oz)
Rail	Black anodized aluminum 6000 series	830 g/m (9 oz/ft)
Rail splice	Aluminum alloy 6000 series	830 g/m (9 oz/ft)
Rail bolt	M10-1.5 x 25 mm; custom T-head SS304	18 g (0.63 oz)
Rail nut	M10-1.5; DIN 6923 SS304	nominal
Ground lug assembly	SS304; A2-70 bolt; tin-plated copper lug	106.5 g (3.75 oz)
Row-to-row grounding clip	SS 301 with SS 304 M6 bolts	75 g (2.6 oz)
Row-to-row spacer	Black POM-grade plastic	5 g (0.18 oz)

InvisiMount Operating Conditions	
Temperature	-40° C to 90° C (-40° F to 194° F)
Max. Load (LRFD)	<ul style="list-style-type: none"> <li>• 3000 Pa uplift</li> <li>• 6000 Pa downforce</li> </ul>

Roof Attachment Hardware Supported by Design Tool	
Application	<ul style="list-style-type: none"> <li>• Composition Shingle Rafter Attachment</li> <li>• Composition Shingle Roof Decking Attachment</li> <li>• Curved and Flat Tile Roof Attachment</li> <li>• Universal interface for other roof attachments</li> </ul>

InvisiMount Component LRFD Capacities <sup>2</sup>		
Mid clamp	Uplift	664 lbf
	Shear	540 lbf
End clamp	Uplift	899 lbf
	Shear	220 lbf
Rail	Moment: upward	548 lbf-ft
	Moment: downward	580 lbf-ft
Rail splice	Moment: upward	548 lbf-ft
	Moment: downward	580 lbf-ft
L-foot	Uplift	1000 lbf
	Shear	390 lbf

InvisiMount Warranties And Certifications	
Warranties	<ul style="list-style-type: none"> <li>• 25-year product warranty</li> <li>• 5-year finish warranty</li> </ul>
Certifications	<ul style="list-style-type: none"> <li>• UL 2703 Listed</li> <li>• Class A Fire Rated</li> </ul>

Roof Attachment Hardware Warranties	
Refer to roof attachment hardware manufacturer's documentation.	

<sup>1</sup> Module frame that is compatible with the InvisiMount system required for hardware interoperability.  
<sup>2</sup> SunPower recommends that all Equinox™, InvisiMount™, and AC module systems always be designed using the InvisiMount Span Tables #524734. If a designer decides to instead use the component capacities listed in this document to design a system, note that the capacities shown are Load and Resistance Factor Design (LRFD) design loads, and are NOT to be used for Allowable Stress Design (ASD) calculations; and that a licensed Professional Engineer (PE) must then stamp all calculations. If you have any questions please contact SunPower Technical Support at 1-855-977-7867.

© 2018 SunPower Corporation. All Rights Reserved. SUNPOWER, the SUNPOWER logo, EQUINOX, and INVISIMOUNT are trademarks or registered trademarks of SunPower Corporation. All other trademarks are the property of their respective owners. Specifications included in this datasheet are subject to change without notice.



# SPEC SHEET

Part #	Box Quantity
17660	4" QB2 (25)
17662	3" Microflashing® (25); 4" QB2 (25); L-Foot (25)



**QB2**  
PN# 17660

Dual Drive Technology  
1/2" Hex Outer Drive  
6mm Inner Drive

MATERIAL: Stainless Steel 304

SURFACE TREATMENT: PASSIVATION

**QuickBOLT**

NAME:	DATE:	ITEM:	STATUS:
DRAWN:	MAR. 19.19	5/16 X 4" HEX FLANGE QUICK BOLT	Approved
APPROVED:	MAR. 19.19	DRAWING NO. SL20190316-1	
VERSION: 01	FORMAT: A3	Scale: 5:1	SALES:
TOLERANCE: AS PER DRAWING	ISO:	PAGES: 1/1	UNIT: METRIC

PN# 17661  
L-Foot for QB2

Part # 17669

5/16" x 3"  
304 Stainless Steel  
**Compression Washer Black**



## Eaton general duty cartridge fuse safety switch

DG222NRB

UPC:782113144221

### Dimensions:

- **Height:** 14.37 IN
- **Length:** 7.35 IN
- **Width:** 8.4 IN

**Weight:**10 LB

**Notes:**Maximum hp ratings apply only when dual element fuses are used. 3-Phase hp rating shown is a grounded B phase rating, UL listed.

### Warranties:

- Eaton Selling Policy 25-000, one (1) year from the date of installation of the Product or eighteen (18) months from the date of shipment of the Product, whichever occurs first.

### Specifications:

- **Type:** General duty, cartridge fused
- **Amperage Rating:** 60A
- **Enclosure:** NEMA 3R
- **Enclosure Material:** Painted galvanized steel
- **Fuse Class Provision:** Class H fuses
- **Fuse Configuration:** Fusible with neutral
- **Number Of Poles:** Two-pole
- **Number Of Wires:** Three-wire
- **Product Category:** General duty safety switch
- **Voltage Rating:** 240V

### Supporting documents:

- [Eatons Volume 2-Commercial Distribution](#)
- [Eaton Specification Sheet - DG222NRB](#)

### Certifications:

- UL Listed

**Product compliance:** No Data



## Eaton general duty non-fusible safety switch

DG222URB

UPC:782113144238

### Dimensions:

- **Height:** 14.38 IN
- **Length:** 7.38 IN
- **Width:** 8.69 IN

**Weight:**9 LB

**Notes:**WARNING! Switch is not approved for service entrance unless a neutral kit is installed.

### Warranties:

- Eaton Selling Policy 25-000, one (1) year from the date of installation of the Product or eighteen (18) months from the date of shipment of the Product, whichever occurs first.

### Specifications:

- **Type:** Non-fusible, single-throw
- **Amperage Rating:** 60A
- **Enclosure:** NEMA 3R, Rainproof
- **Enclosure Material:** Painted galvanized steel
- **Fuse Configuration:** Non-fusible
- **Number Of Poles:** Two-pole
- **Number Of Wires:** Two-wire
- **Product Category:** General duty safety switch
- **Voltage Rating:** 240V

### Supporting documents:

- [Eatons Volume 2-Commercial Distribution](#)
- [Eaton Specification Sheet - DG222URB](#)

### Certifications:

- UL Listed

**Product compliance:** No Data



## Eaton CH main lug loadcenter

CH8L125RP

UPC:782114190548

### Dimensions:

- **Height:** 3.69 IN
- **Length:** 13 IN
- **Width:** 11 IN

**Weight:** 12 LB

**Notes:** Ground bar kits priced separately. Suitable for use as service equipment when not more than two service disconnecting mains are provided or when not used as a lighting and appliance panelboard.

### Warranties:

- Limited lifetime

### Specifications:

- **Special Features:** Cover included
- **Type:** Main lug only
- **Amperage Rating:** 125A
- **Box Size:** 7r
- **Bus Material:** Copper
- **Enclosure:** NEMA 3R
- **Enclosure Material:** Metallic
- **Feed Type:** Overhead
- **Main Circuit Breaker:** CH
- **Number Of Circuits:** 8
- **Number Of Wires:** Three-wire
- **Phase:** Single-phase
- **Voltage Rating:** 120/240V, 208Y/120, 240V
- **Wire Size:** #6-1/0 AWG

### Supporting documents:

- [Type CH Circuit Breakers and Loadcenters](#)
- [Loadcenters and Circuit Breakers](#)
- [Eatons Volume 1-Residential and Light Commercial](#)



## Eaton CH main lug loadcenter

CH12L125R

UPC:782113097381

### Dimensions:

- **Height:** 5.19 IN
- **Length:** 16.75 IN
- **Width:** 14.31 IN

**Weight:** 15.8 LB

**Notes:** Suitable for use as service equipment when not more than six service disconnecting mains are provided or when not used as a lighting and appliance panelboard. Rainproof panels are furnished with hub closure plates. For rainproof hubs.

### Warranties:

- Limited lifetime

### Specifications:

- **Special Features:** Cover included
- **Type:** Main lug only
- **Amperage Rating:** 125A
- **Box Size:** B
- **Bus Material:** Copper
- **Enclosure:** NEMA 3R
- **Enclosure Material:** Metallic
- **Feed Type:** Overhead
- **Main Circuit Breaker:** CH
- **Number Of Circuits:** 12
- **Number Of Wires:** Three-wire
- **Phase:** Single-phase
- **Voltage Rating:** 120/240V
- **Wire Size:** #6-2/0 AWG

### Supporting documents:

- [Dimensional Drawing - CH 3/4 LOADCENTER, MAIN LUG ONLY, OUTDOOR NEMA 3R, 120/240 VAC, 1 PH](#)





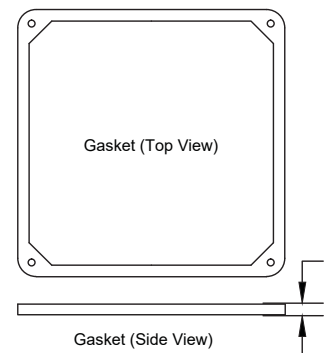
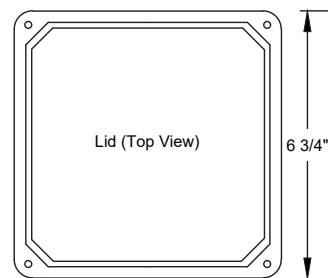
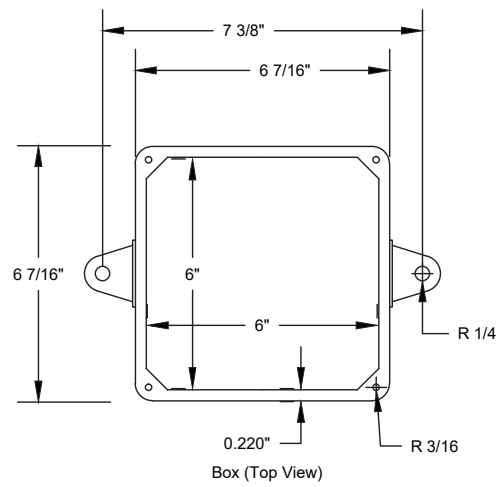
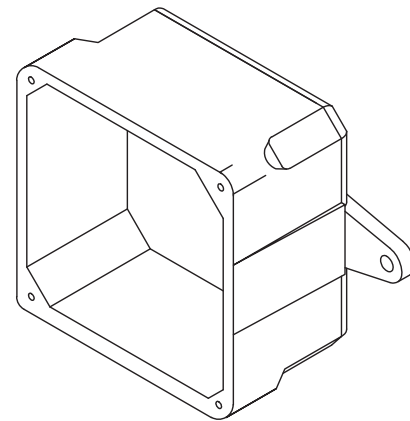
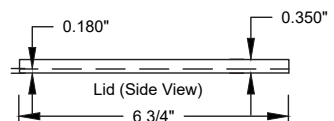
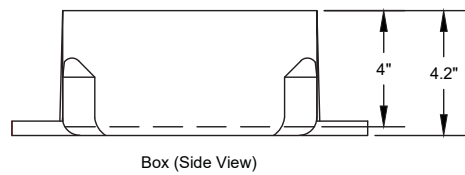

UL Listed  
 Marine Listed  
 UL File # E205935 (QCUP)  
 UL Control # 92CM  
 Material is Rigid PVC  
 132 cu in Volume (2163 cu cm)  
 Screws are Zinc Plated Steel  
 Gasket is neoprene

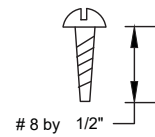

<b>CANTEX</b> INC. Fort Worth, TEXAS		
<b>Junction Box 6 x 6 x 4</b>		
Drawn By: O.M.	Date: 6/19/17	5133710

## POWERWALL

Tesla Powerwall is a fully-integrated AC battery system for residential or light commercial use. Its rechargeable lithium-ion battery pack provides energy storage for solar self-consumption, time-based control, and backup.

Powerwall's electrical interface provides a simple connection to any home or building. Its revolutionary compact design achieves market-leading energy density and is easy to install, enabling owners to quickly realize the benefits of reliable, clean power.



### PERFORMANCE SPECIFICATIONS

AC Voltage (Nominal)	120/240 V
Feed-In Type	Split Phase
Grid Frequency	60 Hz
Total Energy	14 kWh
Usable Energy	13.5 kWh
Real Power, max continuous	5 kW (charge and discharge)
Real Power, peak (10s, off-grid/backup)	7 kW (charge and discharge)
Apparent Power, max continuous	5.8 kVA (charge and discharge)
Apparent Power, peak (10s, off-grid/backup)	7.2 kVA (charge and discharge)
Maximum Supply Fault Current	10 kA
Maximum Output Fault Current	32 A
Overcurrent Protection Device	30 A
Imbalance for Split-Phase Loads	100%
Power Factor Output Range	+/- 1.0 adjustable
Power Factor Range (full-rated power)	+/- 0.85
Internal Battery DC Voltage	50 V
Round Trip Efficiency <sup>1,3</sup>	90%
Warranty	10 years

<sup>1</sup>Values provided for 25°C (77°F), 3.3 kW charge/discharge power.

<sup>2</sup>In Backup mode, grid charge power is limited to 3.3 kW.

<sup>3</sup>AC to battery to AC, at beginning of life.

### COMPLIANCE INFORMATION

Certifications	UL 1642, UL 1741, UL 1973, UL 9540, IEEE 1547, UN 38.3
Grid Connection	Worldwide Compatibility
Emissions	FCC Part 15 Class B, ICES 003
Environmental	RoHS Directive 2011/65/EU
Seismic	AC156, IEEE 693-2005 (high)

### MECHANICAL SPECIFICATIONS

Dimensions <sup>1</sup>	1150 mm x 755 mm x 147 mm (45.3 in x 29.6 in x 5.75 in)
Weight <sup>1</sup>	114 kg (251.3 lbs)
Mounting options	Floor or wall mount

<sup>1</sup>Dimensions and weight differ slightly if manufactured before March 2019. Contact Tesla for additional information.

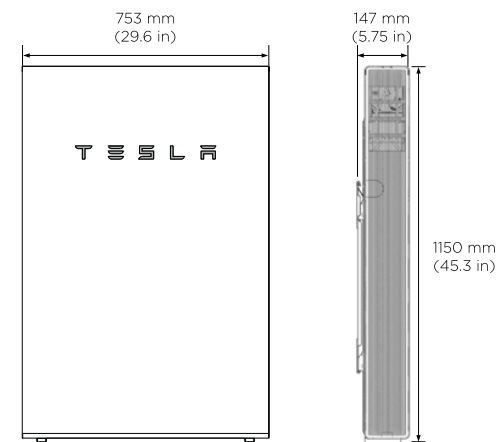

### ENVIRONMENTAL SPECIFICATIONS

Operating Temperature	-20°C to 50°C (-4°F to 122°F)
Recommended Temperature	0°C to 30°C (32°F to 86°F)
Operating Humidity (RH)	Up to 100%, condensing
Storage Conditions	-20°C to 30°C (-4°F to 86°F) Up to 95% RH, non-condensing State of Energy (SoE): 25% initial
Maximum Elevation	3000 m (9843 ft)
Environment	Indoor and outdoor rated
Enclosure Type	NEMA 3R
Ingress Rating	IP67 (Battery & Power Electronics) IP56 (Wiring Compartment)
Wet Location Rating	Yes
Noise Level @ 1m	< 40 dBA at 30°C (86°F)

## POWERWALL

### Backup Gateway 2

The Backup Gateway 2 for Tesla Powerwall provides energy management and monitoring for solar self-consumption, time-based control, and backup.

The Backup Gateway 2 controls connection to the grid, automatically detecting outages and providing a seamless transition to backup power. When equipped with a main circuit breaker, the Backup Gateway 2 can be installed at the service entrance. When the optional internal panelboard is installed, the Backup Gateway 2 can also function as a load center.

The Backup Gateway 2 communicates directly with Powerwall, allowing you to monitor energy use and manage backup energy reserves from any mobile device with the Tesla app.



### PERFORMANCE SPECIFICATIONS

AC Voltage (Nominal)	120/240V
Feed-In Type	Split Phase
Grid Frequency	60 Hz
Current Rating	200 A
Maximum Input Short Circuit Current	10 kA <sup>1</sup>
Overcurrent Protection Device	100-200A; Service Entrance Rated <sup>1</sup>
Overvoltage Category	Category IV
AC Meter	Revenue accurate (+/- 0.2 %)
Primary Connectivity	Ethernet, Wi-Fi
Secondary Connectivity	Cellular (3G, LTE/4G) <sup>2</sup>
User Interface	Tesla App
Operating Modes	Support for solar self-consumption, time-based control, and backup
Backup Transition	Automatic disconnect for seamless backup
Modularity	Supports up to 10 AC-coupled Powerwalls
Optional Internal Panelboard	200A 6-space / 12 circuit Eaton BR Circuit Breakers
Warranty	10 years

<sup>1</sup>When protected by Class J fuses, Backup Gateway 2 is suitable for use in circuits capable of delivering not more than 22kA symmetrical amperes.

<sup>2</sup>The customer is expected to provide internet connectivity for Backup Gateway 2; cellular should not be used as the primary mode of connectivity. Cellular connectivity subject to network operator service coverage and signal strength.

### COMPLIANCE INFORMATION

Certifications	UL 67, UL 869A, UL 916, UL 1741 PCS CSA 22.2 0.19, CSA 22.2 205
Emissions	FCC Part 15, ICES 003

### MECHANICAL SPECIFICATIONS

Dimensions	660 mm x 411 mm x 149 mm (26 in x 16 in x 6 in)
Weight	20.4 kg (45 lb)
Mounting options	Wall mount, Semi-flush mount

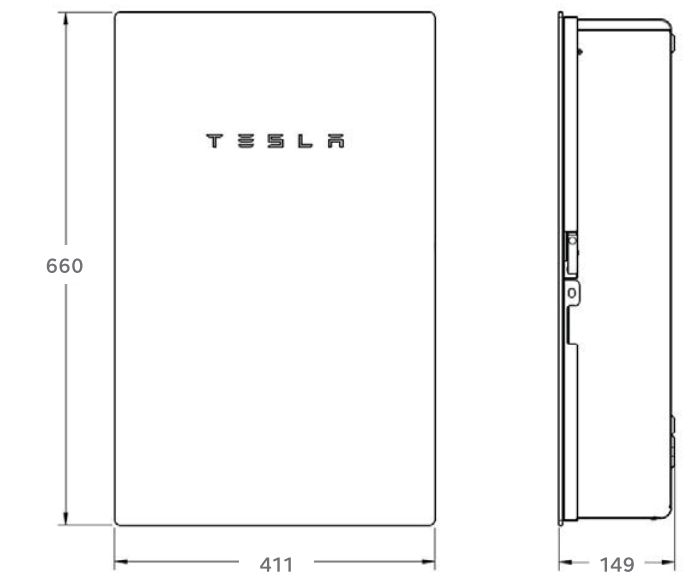

### ENVIRONMENTAL SPECIFICATIONS

Operating Temperature	-20°C to 50°C (-4°F to 122°F)
Operating Humidity (RH)	Up to 100%, condensing
Maximum Elevation	3000 m (9843 ft)
Environment	Indoor and outdoor rated
Enclosure Type	NEMA 3R



## 2.0 Listings, Compatibility, and Classification

The SunPower InvisiMount Residential Mounting System is UL 2703 Listed. The InvisiMount Listing **includes** the following SunPower InvisiMount-compatible modules, **which are the only modules that are compatible with the InvisiMount system:**

DC Modules	AC Modules	
<ul style="list-style-type: none"> <li>• SPR-X22-370</li> <li>• SPR-X22-360</li> <li>• SPR-X21-350-BLK</li> <li>• SPR-X21-335-BLK</li> <li>• SPR-X21-345</li> <li>• SPR-E20-327</li> <li>• SPR-E19-320</li> </ul>	<ul style="list-style-type: none"> <li>• SPR-X22-370-E-AC</li> <li>• SPR-X22-360-E-AC</li> <li>• SPR-X21-350-BLK-E-AC</li> <li>• SPR-X21-335-BLK-E-AC</li> <li>• SPR-X20-327-BLK-E-AC</li> <li>• SPR-X21-345-E-AC</li> <li>• SPR-X21-335-E-AC</li> <li>• SPR-X20-327-E-AC</li> <li>• SPR-E20-327-E-AC</li> <li>• SPR-E19-320-E-AC</li> </ul>	<ul style="list-style-type: none"> <li>• SPR-A425-G-AC</li> <li>• SPR-A420-G-AC</li> <li>• SPR-A415-G-AC</li> <li>• SPR-A400-G-AC</li> <li>• SPR-A390-G-AC</li> </ul>

Grounding from the module to the rail is accomplished through both the mid clamp and end clamp. The Listing also includes the following components, which have been evaluated for both mounting and bonding in accordance with UL 2703:

- end clamp
- mid clamp
- rail
- splice and splice screw
- ground lug assembly
- L-foot
- row-to-row (R2R) grounding clip
- row-to-row (R2R) spacer

