



PALMETTO

+1 843-720-1844
997 MORRISON DR SUITE #200,
CHARLESTON, SC 29403, USA
Need on-site installation support?
Palmetto Installation Hotline
Call or Text: 1-843-258-5389
InstallHotline@Palmetto.com

David C. Hernandez

Digitally signed by David C. Hernandez
Date: 2023.03.29 15:08:19 -04:00

032323

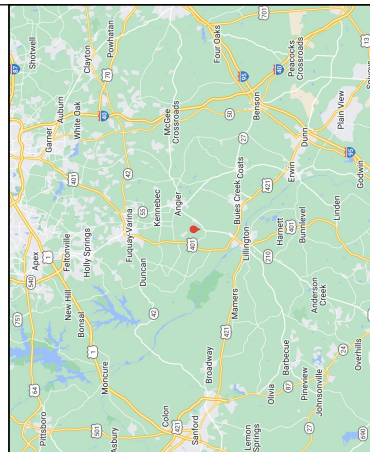

RESIDENTIAL SOLAR PHOTOVOLTAIC SYSTEM 211 CHEDWORTH DR ANGIER, NC 27501

10.935 kW DC-STC / 7.600 kW AC
28/MAR/23

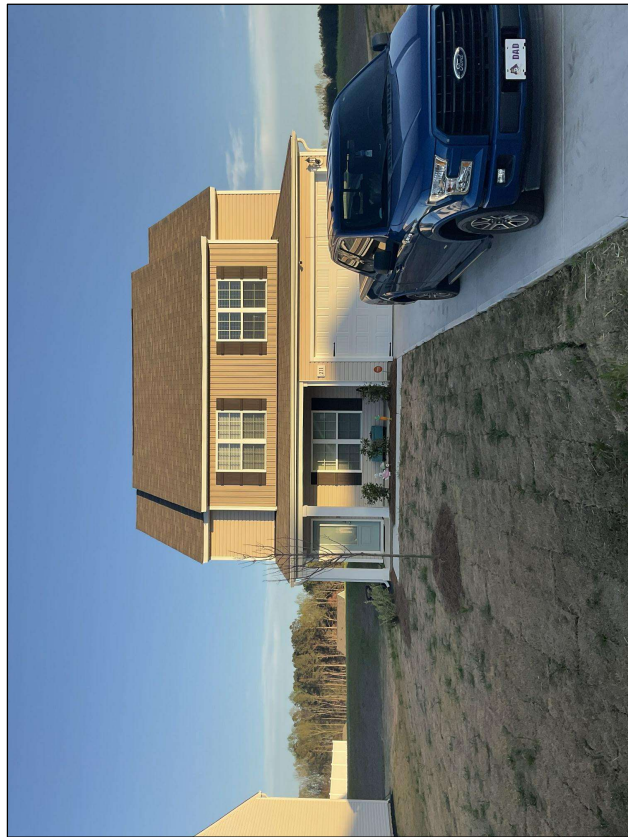

SYSTEM SPECIFICATIONS

SYSTEM SIZE: 10.935 kW
MODULE: VSUN 405-1085MH 405 W
NUMBER OF PANELS: 27
INVERTER: SE7600H-US (240V)
OPTIMIZER: S440
RACKING SYSTEM: IRONRIDGE XR-10-168M

UTILITY: DUKE ENERGY PROGRESS (DEP) (NC)
GOVERNING CODE:
2018 NORTH CAROLINA BUILDING CODE
2018 NORTH CAROLINA FIRE CODE
2018 NORTH CAROLINA RESIDENTIAL CODE FOR
ONE AND TWO-FAMILY DWELLINGS
NEC 2017

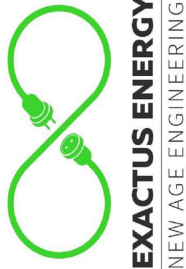

EXACTUS ENERGY
NEW AGE ENGINEERING

+1 833 392 2887
208-888 DUPONT STREET
TORONTO, ON

SHEET INDEX

C1 - COVER PAGE
N1 - GENERAL NOTES
G1 - SITE PLAN
G2 - PANEL LAYOUT
G3 - MOUNTING DETAIL
E1 - LINE DIAGRAM
E2 - WARNING LABELS
E3 - PLACARD
A1 - PANELS SPECIFICATIONS
A2 - RACKING SPECIFICATIONS
A3 - BONDING AND GROUNDING SPECIFICATIONS
A4 - MOUNTING SPECIFICATIONS
A5 - INVERTER SPECIFICATIONS
A6 - OPTIMIZERS SPECIFICATIONS

C1 - COVER PAGE

GENERAL NOTES:

- THE INSTALLATION OF PV SYSTEM SHALL BE IN ACCORDANCE WITH THE MOST RECENT NATIONAL ELECTRICAL AND BUILDING CODES AND STANDARDS, AS AMENDED BY JURISDICTION
- PV SYSTEMS SHALL BE PERMITTED TO SUPPLY A BUILDING OR OTHER STRUCTURE IN ADDITION TO ANY OTHER ELECTRICAL SUPPLY SYSTEM(S) [NEC 690.4(A)]
- THE INSTALLATION OF EQUIPMENT AND ALL ASSOCIATED WIRING AND INTERCONNECTION SHALL BE PERFORMED ONLY BY QUALIFIED PERSONS [NEC 690.4(C)]
- EXISTING PLUMBING VENTS, SKYLIGHTS, EXHAUST OUTLETS, VENTILATIONS INTAKE AIR OPENINGS SHALL NOT BE COVERED BY THE SOLAR PHOTOVOLTAIC SYSTEM
- INVERTERS, MOTOR GENERATORS, PHOTOVOLTAIC MODULES, PHOTOVOLTAIC PANELS, AC PHOTOVOLTAIC MODULES, SOURCE-CIRCUIT COMBINERS, AND CHARGE CONTROLLERS INTENDED FOR USE IN PV SYSTEMS SHALL BE LISTED OR FIELD LABELED FOR THE PV APPLICATION [NEC 690.4(B)]
- ALL OUTDOOR EQUIPMENT SHALL BE NEMA 3R RATED (OR BETTER), INCLUDING ALL ROOF MOUNTED TRANSITION BOXES AND SWITCHES.
- ALL EQUIPMENT SHALL BE PROPERLY GROUNDED AND BONDED IN ACCORDANCE WITH NEC ARTICLE 250.
- SYSTEM GROUNDING SHALL BE IN ACCORDANCE WITH NEC 690.41
- FOR PV MODULES, EQUIPMENT GROUNDING CONDUCTORS SMALLER THAN 6AWG SHALL COMPLY WITH NEC 250.12(C) [NEC 690.46]
- ALL PV SYSTEM DC CIRCUIT AND INVERTER OUTPUT CONDUCTORS AND EQUIPMENT SHALL BE PROTECTED AGAINST OVERCURRENT UNLESS STATED OTHERWISE IN NEC 690.9(A)
- OVERCURRENT DEVICES USED IN PV SYSTEM DC CIRCUITS SHALL BE LISTED FOR USE IN PV SYSTEMS [NEC 690.9(B)]
- PV SYSTEM CIRCUITS INSTALLED ON OR IN BUILDINGS SHALL INCLUDE A RAPID SHUTDOWN FUNCTION IN ACCORDANCE WITH NEC 690.12
- DISCONNECTING MEANS SHALL BE LOCATED IN A VISIBLE, READILY ACCESSIBLE LOCATION OR A MAXIMUM OF 10 FEET AWAY FROM THE SYSTEM [NEC 690.13(A)]
- ALL WIRING METHODS SHALL BE IN ACCORDANCE WITH NEC 690.31
- CONNECTORS SHALL REQUIRE A TOOL TO OPEN AND BE MARKED "DO NOT DISCONNECT UNDER LOAD" OR "NOT FOR CURRENT INTERRUPTING". [NEC 690.33(E)]
- ALL GROUNDED CONDUCTORS SHALL BE PROPERLY COLOR IDENTIFIED AS WHITE. [NEC 200.6]
- PV SYSTEM CONNECTED ON THE LOAD SIDE OF THE SERVICE DISCONNECTING MEANS OF THE OTHER SOURCE(S) AT ANY DISTRIBUTION EQUIPMENT ON THE PREMISES SHALL MEET THE FOLLOWING [NEC 705.12(B)]:

 1. EACH SOURCE CONNECTION SHALL BE MADE AT A DEDICATED CIRCUIT BREAKER OF FUSIBLE DISCONNECTING MEANS. [NEC 705.12(B)(1)]
 2. 125 PERCENT OF THE POWER SOURCE OUTPUT CIRCUIT CURRENT SHALL BE USED IN AMPACITY CALCULATIONS. [NEC 705.12(B)(2)]
 3. EQUIPMENT CONTAINING OVERCURRENT DEVICES IN CIRCUITS SUPPLYING POWER TO A BUS BAR OR CONDUCTOR SHALL BE MARKED TO INDICATE THE PRESENCE OF ALL SOURCES. [NEC 705.12(B)(3)]
 4. CIRCUIT BREAKER, IF BACK FED, SHALL BE SUITABLE FOR SUCH OPERATION [NEC 705.12(B)(4)]

- WHEN A BACKFED BREAKER IS THE METHOD OF UTILITY INTERCONNECTION, THE BREAKER SHALL BE INSTALLED AT THE OPPOSITE END OF THE BUS BAR OF THE MAIN BREAKER.
- TO REDUCE FIRE HAZARDS, DC PV SYSTEMS WILL BE EQUIPPED WITH A GROUND FAULT PROTECTION SYSTEM IN ACCORDANCE WITH NEC 690.41(B)
- WHERE GROUND-FAULT PROTECTION IS USED, THE OUTPUT OF AN INTERACTIVE SYSTEM SHALL BE CONNECTED TO THE SUPPLY SIDE OF THE GROUND FAULT PROTECTION [NEC 705.32]
- ALL PLAQUES AND SIGNAGE REQUIRED BY THE LATEST EDITION OF NATIONAL ELECTRICAL CODE. LABEL SHALL BE METALLIC OR PLASTIC, ENGRAVED OR MACHINE PRINTED IN A CONTRASTING COLOR TO THE PLAQUE. PLAQUE SHALL BE UV RESISTANT IF EXPOSED TO SUNLIGHT
- ALL THE NEC REQUIRED WARNING SIGNS, MARKINGS, AND LABELS SHALL BE POSTED ON EQUIPMENT AND DISCONNECTS PRIOR TO ANY INSPECTIONS TO BE PERFORMED BY THE BUILDING DEPARTMENT.
- CONNECTORS SHALL BE OF LATCHING OR LOCKING TYPE. CONNECTORS THAT ARE READILY ACCESSIBLE AND OPERATING AT OVER 30 VOLTS SHALL REQUIRE TOOL TO OPEN AND MARKED "DO NOT DISCONNECT UNDER LOAD" OR "NOT FOR CURRENT INTERRUPTING". [NEC 690.33(C) & (E)(2)]
- FLEXIBLE, FINE-STRANDED CABLES SHALL BE TERMINATED ONLY WITH TERMINALS, LUGS, DEVICES, OR CONNECTORS IN ACCORDANCE WITH NEC 110.14
- WORK CLEARANCES AROUND ELECTRICAL EQUIPMENT WILL BE MAINTAINED PER NEC 110.26(A)(1), 110.26(A)(2) AND 110.26(A)(3)
- ALL EXTERIOR CONDUITS, FITTINGS AND BOXES SHALL BE RAIN-TIGHT AND APPROVED FOR USE IN WET LOCATIONS PER NEC 314.15.
- ROOFTOP MOUNTED PHOTOVOLTAIC PANELS AND MODULES SHALL BE TESTED, LISTED & IDENTIFIED IN ACCORDANCE WITH UL 1703
- EACH MODULE TO BE GROUNDED USING THE SUPPLIED CONNECTION POINT PER MANUFACTURER'S REQUIREMENTS. ALL SOLAR MODULES, EQUIPMENT, AND METALLIC COMPONENTS ARE TO BE BONDED. IF THE EXISTING GROUNDING ELECTRODE SYSTEM CAN NOT BE VERIFIED OR IS ONLY METALLIC WATER PIPING, IT IS THE CONTRACTOR'S RESPONSIBILITY TO INSTALL A SUPPLEMENTAL GROUNDING ELECTRODE.
- DC CONDUCTORS SHALL BE RUN IN EMT AND SHALL BE LABELED "CAUTION DC CIRCUIT" OR EQUIV. EVERY 5 FT
- CONFIRM LINE SIDE VOLTAGE AT ELECTRIC UTILITY SERVICE PRIOR TO CONNECTING INVERTER. VERIFY SERVICE VOLTAGE IS WITHIN INVERTER VOLTAGE OPERATIONAL RANGE.
- SERVING UTILITY TO BE NOTIFIED BEFORE ACTIVATION OF PV SYSTEM.
- ELECTRICAL CONTRACTOR TO PROVIDE CONDUIT EXPANSION JOINTS AND ANCHOR CONDUIT RUNS AS REQUIRED PER NEC.
- THE HOMEOWNER IS RESPONSIBLE FOR ENSURING ALL EQUIPMENT OUTSIDE THE SCOPE OF WORK IS NEC COMPLIANT.

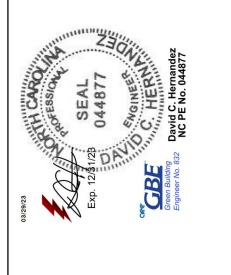

N1 - GENERAL NOTES
Need on-site installation support?
 Palmetto Installation Hotline
 Call or Text: 1-843-258-5389
 Install.Hotline@Palmetto.com

AUTHOR: ----
DATE: 28/MAR/23
REV.: -

PROJECT: 211 CHEDWORTH DR
MUNICIPALITY: ANGIER, NC
ZIP CODE: 27501
CLIENT: MS. ERICK N DAVILA
 10.935 KW DC-STC / 7.600 KW AC

PALMETTO
PHONE: +1 843-720-1844
WWW.PALMETTO.COM



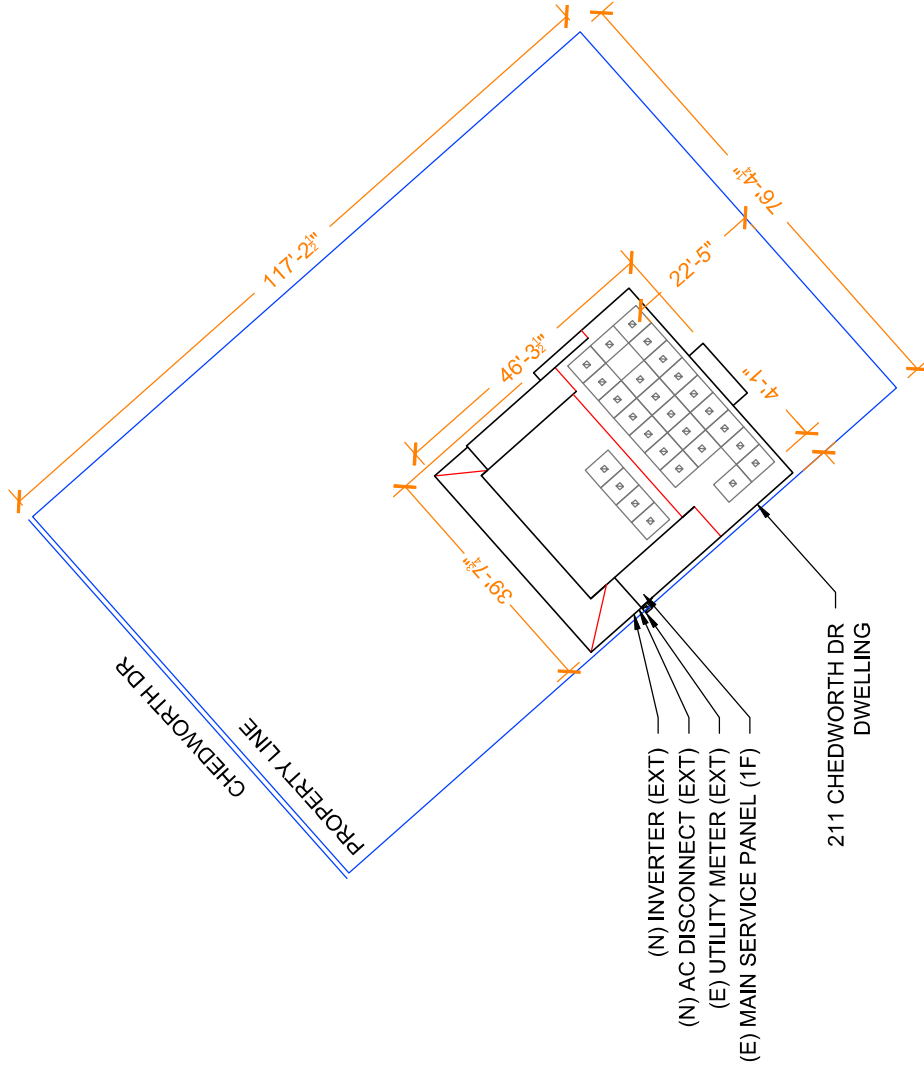

- (N) INVERTER (EXT)
- (N) AC DISCONNECT (EXT)
- (E) UTILITY METER (EXT)
- (E) MAIN SERVICE PANEL (1F)

211 CHEDWORTH DR
DWELLING

SCALE: 1"=20'

NOTES:

- SCALE AS SHOWN
- ALL DIMENSIONS IN FEET UNLESS OTHERWISE STATED

SAFETY PLAN:

- INSTALLERS SHALL DRAW IN DESIGNATED SAFETY AREA AROUND HOME
- INSTALLERS SHALL UPDATE NAME, ADDRESS, AND PHONE NUMBER OF NEAREST URGENT CARE FACILITY RELATIVE TO THE SITE BEFORE STARTING WORK

NEAREST URGENT CARE FACILITY

NAME:
ADDRESS:
PHONE NUMBER:



PALMETTO
PHONE: +1 843-720-1844
WWW.PALMETTO.COM

PROJECT: 211 CHEDWORTH DR
MUNICIPALITY: ANGLIER, NC
ZIP CODE: 27501
CLIENT: MS. ERICK N DAVILA
10.935 KW DC-STC / 7.600 KW AC

AUTHOR: ----
DATE: 28/MAR/23
REV: -

G1 - SITE PLAN
Need on-site installation support?
Palmetto Installation Hotline
Call or Text: 1-843-258-5389
InstallHotline@Palmetto.com



Exp. 12/31/23
Exp. 12/31/23
Engineer No. 152
N.C.P.E. No. 044877

SITE INFORMATION

ARRAY	AZIMUTH	PITCH	NO. OF PANELS	ARRAY AREA (SQ. FT.)	ROOF TYPE	ATTACHMENT	FRAME SIZE & FRAME TYPE	FRAME SPACING	MAX ATTACHMENT SPAN	OVERHANG
ROOF 1	138°	30°	23	483.52	COMPOSITE SHINGLE	QUICK MOUNT L-MOUNT	2" X 4" PRE FABRICATED TRUSSES	2'-0"	4'-0"	1'-4"
ROOF 2	318°	30°	4	84.09	COMPOSITE SHINGLE	QUICK MOUNT L-MOUNT	2" X 4" PRE FABRICATED TRUSSES	2'-0"	4'-0"	1'-4"

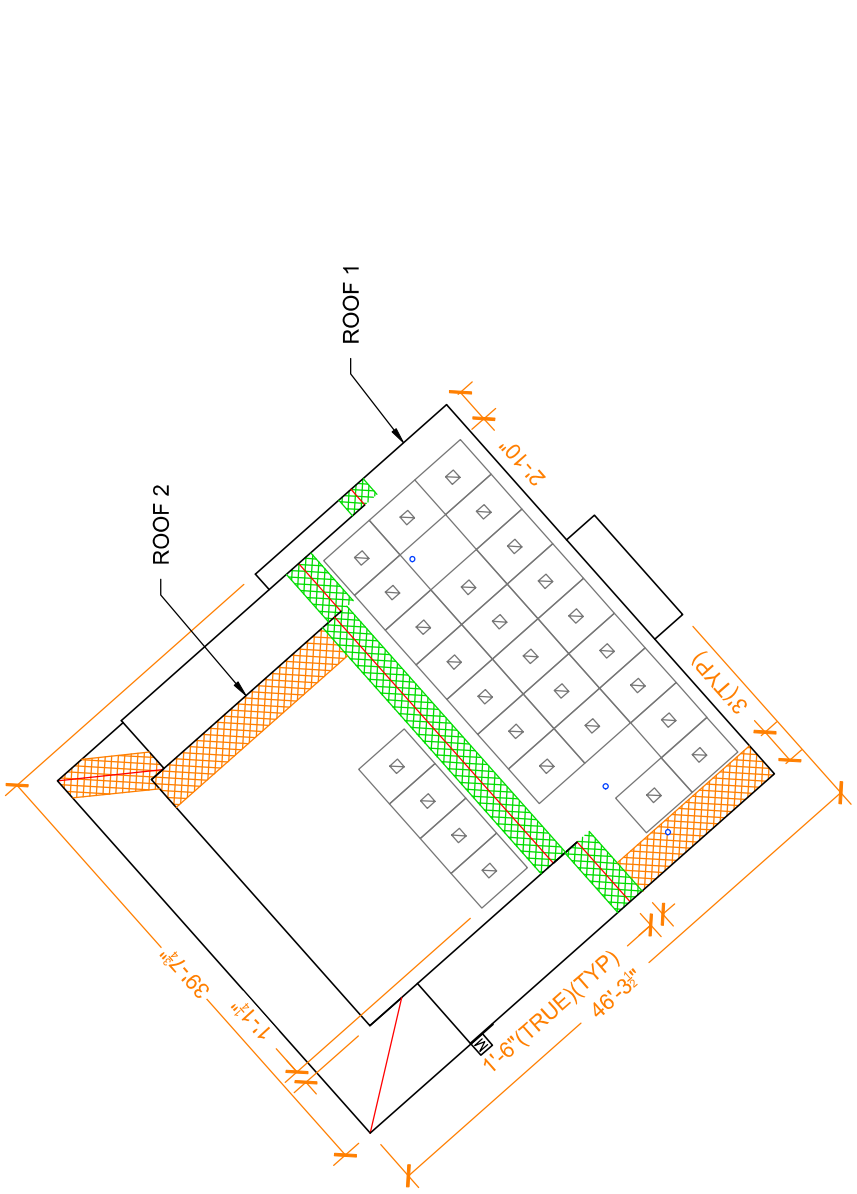
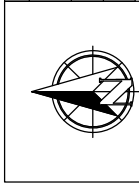

LEGEND

- [M] METER
- [Hatched Box] 36" FIRE ACCESS PATH
- [Green Hatched Box] 18" FIRE VENTILATION
- [Blue Circle] PVC VENT
- [Blue X] METAL VENT
- [Red Square] VENT BOX
- [Blue Line] STRUCTURAL DELIMITER
- [Blue Circle] SERVICE MAST
- [Blue Oval] SATELLITE
- [Blue Triangle] ANTENNA
- [Green Line] SNOW GUARD
- [Yellow Line] DOWNSPOUT
- [Red Circle] MOUNT
- [Green Line] RAIL
- [Purple Line] TOP CHORD
- [Orange Box] CHIMNEY

PANELS DATA

PANEL TYPE	VSUN 405-108BMH 405 W
NO. OF PANELS	27
PANEL SIZE	67.80" X 44.65"
PANEL WEIGHT (LBS)	47.18
PANEL AREA (FT ²)	21.02
UNIT WEIGHT OF AREA (LBS/FT ²)	2.24

MOUNTING PATTERN SAMPLE

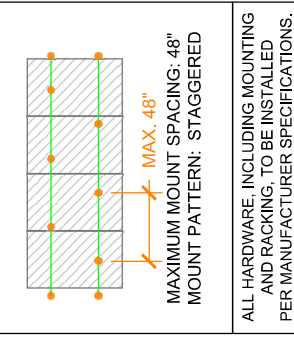

ALL HARDWARE, INCLUDING MOUNTING AND RACKING, TO BE INSTALLED PER MANUFACTURER SPECIFICATIONS.

- NOTES:**
- SOLAR PANEL LAYOUT SUBJECT TO CHANGE ACCORDING TO EXISTING CONDITIONS
 - SCALE AS SHOWN
 - ALL DIMENSIONS IN FEET UNLESS OTHERWISE STATED

MODULE WATTAGE: 405 W
 NUMBER OF PANELS: 27
 SYSTEM SIZE: 10,935 kW

TOTAL ROOF AREA: 1924.62 FT²
 TOTAL ARRAY AREA: 567.61 FT²
 TOTAL ARRAY PERCENT COVERAGE: 29.49%

PROJECT: 211 CHEDWORTH DR
 MUNICIPALITY: ANGIER, NC
 ZIP CODE: 27501
 CLIENT: MS. ERICK N DAVILA
 10,935 KW DC-STC / 7,600 KW AC

PAALMETTO
 PHONE: +1 843-720-1844
 WWW.PALMETTO.COM

Need on-site installation support?
 Palmetto Installation Hotline
 Call or Text: 1-843-258-5389
 InstallHotline@Palmetto.com

AUTHOR: ----
DATE: 28/MAR/23
REV: -

G2 - PANEL LAYOUT

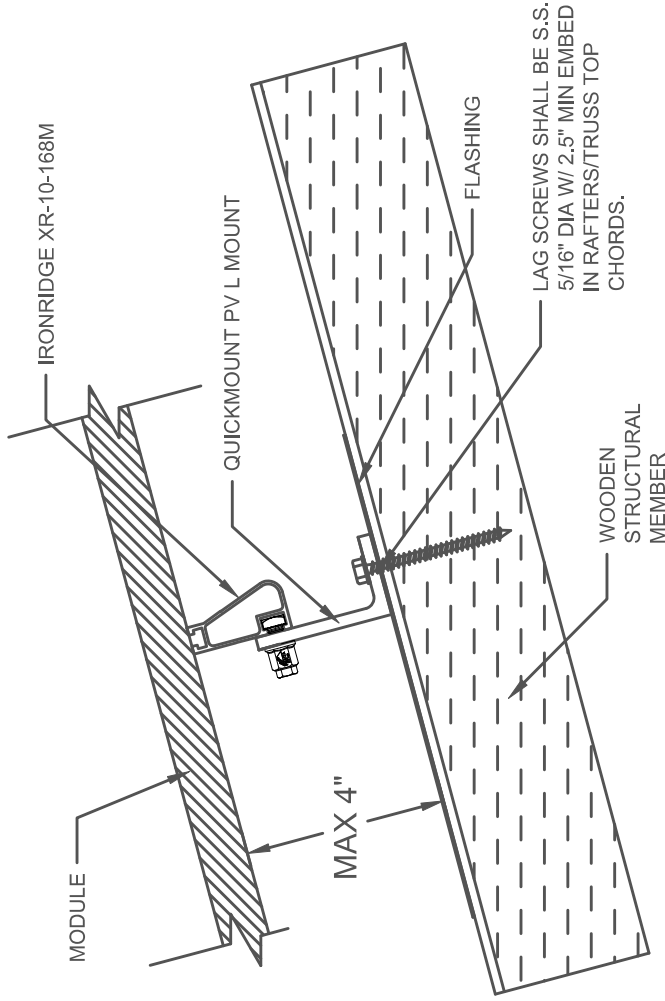

SCALE: NTS

PANEL TYPE: VSUN 405-108BMH 405 W
 PANEL SIZE: 67.80" X 44.65"
 RACKING TYPE: IRONRIDGE XR-10-168M
 MOUNT TYPE: QUICK MOUNT L-MOUNT
 SOLAR SYSTEM DEAD LOAD: 3.0 PSF



PALMETTO
 PHONE: +1 843-720-1844
 WWW.PALMETTO.COM

PROJECT: 211 CHEDWORTH DR
 MUNICIPALITY: ANGIER, NC
 ZIP CODE: 27501
 CLIENT: MS. ERICK N DAVILA
 10,935 KW DC-STC / 7,600 KW AC

NOTES:

- SCALE AS SHOWN
- ALL DIMENSIONS IN FEET UNLESS OTHERWISE STATED

AUTHOR: ----
 DATE: 28/MAR/23
 REV: -

G3 - MOUNTING DETAIL
Need on-site installation support?
 Palmetto Installation Hotline
 Call or Text: 1-843-258-5389
 InstallHotline@Palmetto.com



UTILITY METER NUMBER: 343679028

NABCEP PV PROFESSIONAL LICENSE: PV-102415-012615

ELECTRICAL CONTRACTOR LICENSE: U.32289

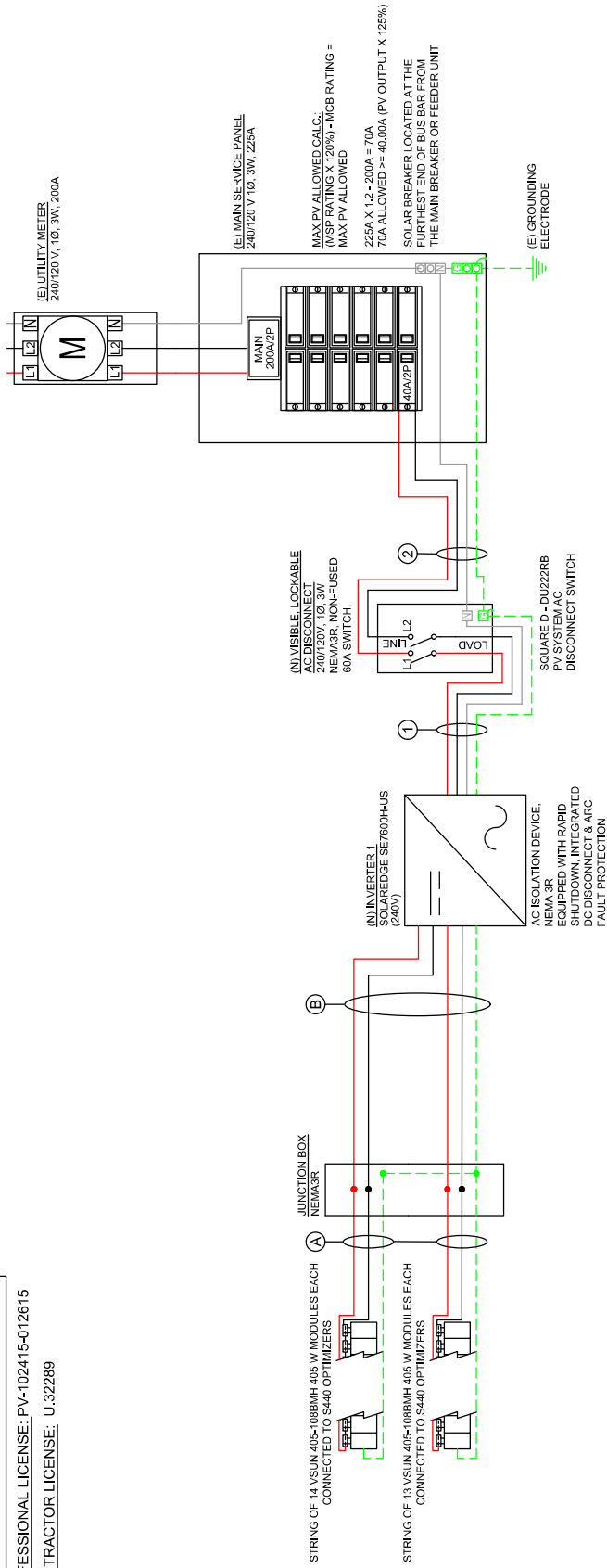

AC CONDUCTOR SCHEDULE

ID	From	To	AC Voltage	Phase	Circuit Current	80% or 100% Based OCPD Current x 125% (If Present)	OCPD	Material	Conductor Type	# of CCCs	Fill Factor	Ambient Temp.	Temp. Factor	Conductor Ampacity @ 75°C	Max Ampacity	Derated Ampacity	Neutral Size	Ground EGC	Ground Material	Ground Type	Ground Size	Conduit Type	Conduit Size
1	SolarEdge Inverter 1	AC Disconnect	240(V)	1D	32.0(A)	80%	40.0(A)	CU	THWN-2	2	1.00	32.9(°C)	0.96	8.8(AWG)	50(A)	55(A)	8.8(AWG)	EGC	CU	THWN-2	10(AWG)	EMT	0.75 (in.)
2	AC Disconnect	POI	240(V)	1D	32.0(A)	80%	40.0(A)	CU	THWN-2	2	1.00	32.9(°C)	0.96	8.8(AWG)	50(A)	55(A)	8.8(AWG)	EGC	CU	THWN-2	10(AWG)	EMT	0.75 (in.)

SOLAREDGE DC CONDUCTOR SCHEDULE

(A) FREE AIR

TEMPERATURE FACTOR IS BASED ON 2% DRY BULB HIGH TEMPERATURE OF 32.9°C WITH A 0°C TEMPERATURE ADDBR THEREFORE RACEWAYS MUST BE AT LEAST 0.875 INCHES ABOVE ROOF AS PER NEC 310.15(B)(3)(C)

Number of Strands	Conductor Type	Conductor Material	Conductor Size	Fill Factor	Temp. Factor	Ambient Temp.	Temp. Factor	Conductor Ampacity @ 75°C	Min. OCPD (If Required)	Derated Ampacity	EGC	Conduit
1	PV Wire	CU	10(AWG)	1.00	0.96	32.9°C	0.96	15.00A	20A	15.00A	EGC	N/A - Free Air

(B) IN CONDUIT

TEMPERATURE FACTOR IS BASED ON 2% DRY BULB HIGH TEMPERATURE OF 32.9°C WITH A 0°C TEMPERATURE ADDBR THEREFORE RACEWAYS MUST BE AT LEAST 0.875 INCHES ABOVE ROOF AS PER NEC 310.15(B)(3)(C)

**CALCULATIONS ARE BASED ON THE LARGEST CIRCUIT CURRENT (WORST CASE SCENARIO).

***TABLE ASSUMES ONE EGC PER CONDUIT. MINIMUM ONE EGC IS REQUIRED PER INVERTER PER CONDUIT.

Number of Strands	Conductor Type	Conductor Material	Conductor Size	Fill Factor	Temp. Factor	Ambient Temp.	Temp. Factor	Conductor Ampacity @ 75°C	Min. OCPD (If Required)	Derated Ampacity	EGC	Conduit
1	PV Wire	CU	10(AWG)	0.80	0.96	32.9°C	0.96	15.00A	20A	15.00A	EGC	0.50 in.



PALMETTO
 PHONE: +1 843-720-1844
 WWW.PALMETTO.COM

PROJECT: 211 CHEDWORTH DR
 MUNICIPALITY: ANGIER, NC
 ZIP CODE: 27501
 CLIENT: MS. ERICK N DAVILA
 10.935 KW DC-STC / 7.600 KW AC

AUTHOR: ----
 DATE: 28/MAR/23
 REV: -

E1 - LINE DIAGRAM
 Need on-site installation support?
 Palmetto Installation Hotline
 Call or Text: 1-843-258-5389
 InstallHotline@Palmetto.com

032923

SEAL
 044877

DAVID C. HEWITT
 ENGINEER

GBE
 Carolina Building Engineers
 Engineer No. 152
 Exp. 12/31/23
 NCP E No. 044877

WARNING
ELECTRIC SHOCK HAZARD
TERMINALS ON BOTH THE LINE AND LOAD
SIDES MAY BE
ENERGIZED IN THE OPEN POSITION

CODE REF: [NEC 690.13(B)]
LOCATION: PLACE ON ALL DISCONNECTING
MEANS WHERE ENERGIZED IN AN OPEN
POSITION

WARNING
TURN OFF PHOTOVOLTAIC AC
DISCONNECT PRIOR TO
WORKING INSIDE PANEL

CODE REF: [NEC 110.27(C) & OSHA 1910.14(07)]
LOCATION: PLACE ON ALL COMBINER
DISCONNECT, BREAKER PANEL & PULL BOXES

WARNING
THIS EQUIPMENT FED BY
MULTIPLE SOURCES

TOTAL RATING OF ALL OVERCURRENT
DEVICES EXCLUDING MAIN POWER SUPPLY
SHALL NOT EXCEED CAPACITY OF BUSBAR

WARNING
THE DISCONNECTION OF THE
GROUNDED CONDUCTOR(S)
MAY RESULT IN OVERVOLTAGE
ON THE EQUIPMENT

CODE REF: [NEC 690.31(F)]
LOCATION: PLACE ON ALL DISCONNECTING
MEANS WHERE ENERGIZED IN AN OPEN
POSITION

WARNING
DUAL POWER SOURCE
SECOND SOURCE IS PHOTOVOLTAIC
SYSTEM

CODE REF: [NEC 705.12(B)(3) & 690.39]
LOCATION: PLACE LABEL ON ALL EQUIPMENT
CONTAINING OVERCURRENT DEVICES IN
CIRCUITS SUPPLYING POWER TO LOADS
FROM MULTIPLE SOURCES

WARNING
POWER SOURCE OUTPUT
CONNECTION
DO NOT RELOCATE THIS OVERCURRENT
DEVICE

CODE REF: [NEC 705.12(B)(2)(b)]
LOCATION: PLACE LABEL ON ALL EQUIPMENT
CONTAINING OVERCURRENT DEVICES IN
CIRCUITS SUPPLYING POWER TO LOADS
TO A BUSBAR OR CONDUCTORS SUPPLIED
FROM MULTIPLE SOURCES

CAUTION
PHOTOVOLTAIC SYSTEM CIRCUIT IS
BACKFEED

CODE REF: [NEC 705.12(B)(1) & 690.39]
LOCATION: PLACE LABEL ON ALL EQUIPMENT
CONTAINING OVERCURRENT DEVICES IN
CIRCUITS SUPPLYING POWER TO LOADS
FROM MULTIPLE SOURCES

**RAPID SHUTDOWN SWITCH
FOR SOLAR PV SYSTEM**

CODE REF: [NEC 690.56(C)(3)]
LOCATION: PLACE NO MORE THAN 1m (3FT) FROM
SWITCH

**SOLAR PV SYSTEM EQUIPPED WITH
RAPID SHUTDOWN**

TURN RAPID SHUTDOWN
SWITCH TO THE
"OFF" POSITION TO
SHUTDOWN THE SYSTEM
AND REDUCE
SHOCK HAZARD
IN THE ARRAY.

CODE REF: [NEC 690.56(C)]
LOCATION: PLACE AT MAIN SERVICE PANEL

**WARNING: PHOTOVOLTAIC
POWER SOURCE**

CODE REF: [NEC 690.31 (G)(3) & 690.31 (G)(4)]
LOCATION: PLACE ON ALL JUNCTION BOXES, EXPOSED
RACEWAYS EVERY 10'

MAXIMUM VOLTAGE 480 V
MAXIMUM CIRCUIT CURRENT 30 A
**MAX RATED OUTPUT
CURRENT OF DC-TO-DC
CONVERTER (IF INSTALLED)** 15 A

CODE REF: [NEC 690.53]
LOCATION: PLACE AT INVERTER 1

**DO NOT DISCONNECT
UNDER LOAD**

CODE REF: [NEC 690.15(C) & 690.31(E)(2)]
LOCATION: PLACE ON ALL DISCONNECTING
MEANS WHERE ENERGIZED IN AN OPEN POSITION

PHOTOVOLTAIC AC DISCONNECT
RATED AC OUTPUT CURRENT 32A
NOMINAL OPERATING AC VOLTAGE 240V

CODE REF: [NEC 690.54]
LOCATION: PLACE AT P.O.C. TO SERVICE DISTRIBUTION
EQUIPMENT / AC DISCONNECT / PULL BOXES

**PHOTOVOLTAIC
AC DISCONNECT**

CODE REF: [NEC 690.13(B)]
LOCATION: PLACE AT P.O.C. TO SERVICE DISTRIBUTION
EQUIPMENT / AC DISCONNECT / PULL BOXES

**PHOTOVOLTAIC
DC DISCONNECT**

CODE REF: [NEC 690.13(B)]
LOCATION: PLACE ON DC DISCONNECT

NOTES:

- 1) ALL LABELING USED OUTDOORS MUST BE ENGRAVED METAL, UV STABILIZED ENGRAVED PLASTIC OR OF A MATERIAL SUFFICIENTLY DURABLE TO WITHSTAND THE ENVIRONMENT INVOLVED. VALUES HAND WRITTEN OR IN WRITTEN IN MARKER ARE NOT ACCEPTABLE PER NEC 2017.
- 2) LABELS USED INDOORS MAY BE MADE OF DURABLE VINYL OR PAPER
- 3) DO NOT COVER ANY EXISTING MANUFACTURER APPLIED LABELS WITH INSTALLATION SPECIFIC LABELS
- 4) LABEL COLORS CHOSEN PER NFPA 70 2017 DIRECTION THAT ANSI Z535-2011 BE USED
- 5) REQUIREMENTS COMPLY WITH NEC 2017
- 6) ADDITIONALLY IT IS HIGHLY RECOMMENDED THAT THE INSTALLER ATTACH A LABEL WITH THE COMPANY NAME AND CONTACT INFORMATION AT THE INVERTER
- 7) ALL WARNING SIGNS OR LABELS SHALL COMPLY WITH NEC 110.21(B)

FORMAT

1. WHITE LETTERING ON A RED BACKGROUND
2. MINIMUM 3/8 INCHES LETTER HEIGHT
3. ALL LETTERS SHALL BE CAPITALIZED
4. ARIAL OR SIMILAR FONT (NON-BOLD)

MATERIAL

REFLECTIVE, WEATHER RESISTANT MATERIAL SUITABLE FOR THE ENVIRONMENT
(USE UL-969 AS STANDARD FOR WEATHER RATING), DURABLE ADHESIVE MATERIALS

E2 - WARNING LABELS

Need on-site installation support?
Palmetto Installation Hotline
Call or Text: 1-843-258-5389
InstallHotline@Palmetto.com

AUTHOR: ----

DATE: 28/MAR/23

REV: -

PROJECT: 211 CHEDWORTH DR
MUNICIPALITY: ANGIER, NC
ZIP CODE: 27501
CLIENT: MS. ERICK N DAVILA
10,935 KW DC-STC / 7,600 KW AC

PALMETTO
PHONE: +1 843-720-1844
WWW.PALMETTO.COM

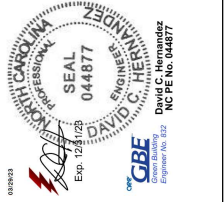

CAUTION:
MULTIPLE SOURCES OF POWER
 POWER TO THIS SERVICE IS ALSO SUPPLIED FROM THE
 FOLLOWING SOURCES WITH DISCONNECTS LOCATED AS SHOWN

RAPID SHUTDOWN DEVICE
 AC DISCONNECT
 UTILITY METER
 MAIN SERVICE PANEL

IN EC 706.10 & NEC 706.11] CUSTOMER SERVICE PANEL, P/VAC DISCONNECT AND
 RAPID SHUTDOWN DEVICE



PALMETTO
 PHONE: +1 843-720-1844
 WWW.PALMETTO.COM

PROJECT: 211 CHEDWORTH DR
MUNICIPALITY: ANGIER, NC
ZIP CODE: 27501
CLIENT: MS. ERICK N DAVILA
 10.935 KW DC-STC / 7.600 KW AC

AUTHOR: ----
DATE: 28/MAR/23
REV: -

E3 - PLACARD
Need on-site installation support?
 Palmetto Installation Hotline
 Call or Text: 1-843-258-5389
 InstallHotline@Palmetto.com





VSUN405-108BMH

405W Highest power output

20.74% Module efficiency

25years Material & Workmanship warranty

30years Linear power output warranty

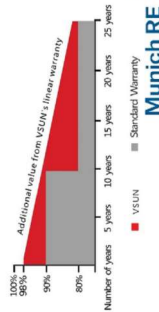

MBB technology with Circular Ribbon

Higher output power

Half-cell Technology

Positive tolerance offer

- Micro Gap
- Up to 30% extra power generation yield from the back side
- Certified for salt/ammonia corrosion resistance
- Load certificates: wind to 2400Pa and snow to 5400Pa
- Lower LCOE

VSUN, a BNEF Tier-1 PV module manufacturer invested by Fuji Solar, has been committed to providing greener, cleaner and more intelligent renewable energy solutions. VSUN is dedicated to bringing reliable, customized and high-efficient products into various markets and customers worldwide



PROJECT: 211 CHEDWORTH DR
MUNICIPALITY: ANGIER, NC
ZIP CODE: 27501
CLIENT: MS. ERICK N DAVILA
10,935 KW DC-STC / 7.600 KW AC

AUTHOR: ----
DATE: 28/MAR/23
REV: -

A1 - PANELS SPECIFICATIONS
Need on-site installation support?
Palmetto Installation Hotline
Call or Text: 1-843-258-5389
InstallHotline@Palmetto.com

最も信頼出来る再エネパートナー

Electrical Characteristics at Standard Test Conditions (STC)

Module Type	VSUN405-108BMH	VSUN400-108BMH	VSUN395-108BMH	VSUN390-108BMH
Maximum Power - Pmax (W)	405	400	395	390
Open Circuit Voltage - Voc (V)	37.36	37.2	37.03	36.84
Short Circuit Current - Isc (A)	13.68	13.68	13.59	13.5
Maximum Power Voltage - Vmp (V)	31.16	31.12	31.04	30.96
Maximum Power Current - Imp (A)	12.82	12.84	12.75	12.66
Module Efficiency	20.74%	20.68%	20.23%	19.97%

Standard Test Conditions (STC): irradiance 1,000 W/m²; AM 1.5; module temperature 25°C. Pmax Sorting: 0-5W. Measuring Tolerance: ±3%.
Remark: Electrical data do not refer to a single module and they are not part of the offer. They only serve for comparison among different module types.

Electrical Characteristics with different rear side power gain(reference to 400 front)

Pmax (W)	Voc (V)	Isc (A)	Vmp (V)	Imp (A)	Pmax gain
420	37.1	14.36	31.17	13.48	5%
440	37.1	15.05	31.17	14.12	10%
479	37.2	16.42	31.12	15.41	20%
499	37.2	17.10	31.12	16.05	25%

Temperature Characteristics

NOCT	45°C(L2+Q)	Maximum System Voltage [V]
21.4kg <td>-0.27%/°C <td>1500</td> </td>	-0.27%/°C <td>1500</td>	1500
White toughened safety glass, 3.2 mm <td>-0.048%/°C <td>30</td> </td>	-0.048%/°C <td>30</td>	30
Cell encapsulation <td>-0.32%/°C <td>70%±10%</td> </td>	-0.32%/°C <td>70%±10%</td>	70%±10%

Material Characteristics

Dimensions: 1722x1134x30mm (LxWxH)
Weight: 21.4kg
Frame: Black anodized aluminum profile
Glass: White toughened safety glass, 3.2 mm
Cell encapsulation: T/A (Ethylene vinyl acetate) or POE
Back Sheet: T/A (Ethylene vinyl acetate) or POE
Cells: 12x9 pieces monocrystalline solar cells series strings
IP68, 3 diodes
Junction Box: POZANIT: 500 mm (cable length can be customized, 1-4 mm², compatible with MC4)
Cable&Connector: POZANIT: 500 mm (cable length can be customized, 1-4 mm², compatible with MC4)

Packaging

Dimensions(LxWxH): 1760x1125x1253mm
Container 20': 216
Container 40': 468
Container 40'HC: 936
Temperature Range: -40 °C to + 85 °C
Withstanding Hill: Maximum diameter of 25 mm with impact speed of 23 m/s
Maximum Surface Load: 5,400 Pa
Application class: class A

Dimensions

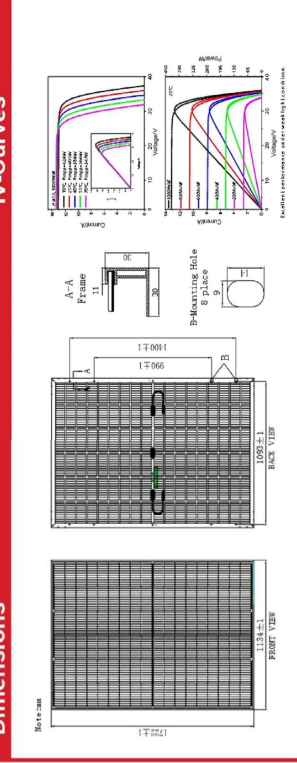

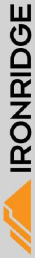

XR10 Rail

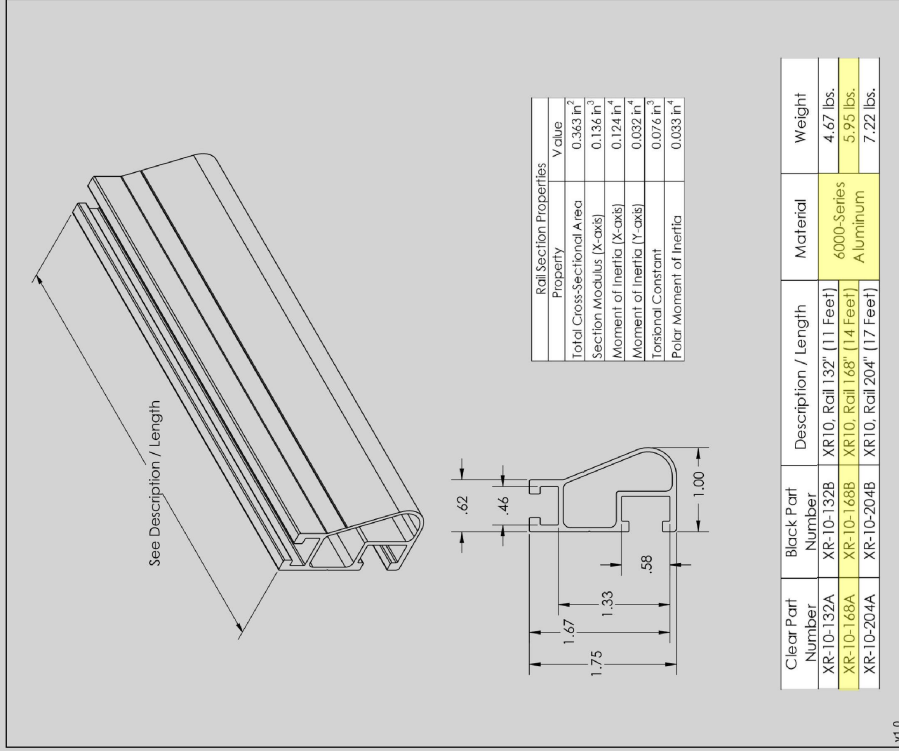

v1.0

Clear Part Number	Black Part Number	Description / Length	Material	Weight
XR-10-132A	XR-10-132B	XR10_Rail [132" (11 Feet)]	6000-Series	4.67 lbs.
XR-10-168A	XR-10-168B	XR10_Rail [168" (14 Feet)]	Aluminum	5.95 lbs.
XR-10-204A	XR-10-204B	XR10_Rail [204" (17 Feet)]	Aluminum	7.22 lbs.

UL Certification

The IronRidge Flush Mount, Tilt Mount, and Ground Mount Systems have been listed to UL 2703 by Intertek Group plc.

UL 2703 is the standard for evaluating solar mounting systems. It ensures these devices will maintain strong electrical and mechanical connections over an extended period of time in extreme outdoor environments.

Go to IronRidge.com/UFO



A2 - RACKING SPECIFICATIONS
Need on-site installation support?
 Palmetto Installation Hotline
 Call or Text: 1-843-258-5389
 InstallHotline@Palmetto.com

AUTHOR: ---
 DATE: 28/MAR/23
 REV: -

PROJECT: 211 CHEDWORTH DR
 MUNICIPALITY: ANGIER, NC
 ZIP CODE: 27501
 CLIENT: MS. ERICK N DAVILA
 10.935 KW DC-STC / 7.600 KW AC

PALMETTO
 PHONE: +1 843-720-1844
 WWW.PALMETTO.COM





UFO Family of Components

Tech Brief

Simplified Grounding for Every Application

The UFO family of components eliminates the need for separate grounding hardware by bonding solar modules directly to IronRidge XR Rails. All system types that feature the UFO family—Flush Mount, Tilt Mount and Ground Mount—are fully listed to the UL 2703 standard.

UFO hardware forms secure electrical bonds with both the module and the rail, resulting in many parallel grounding paths throughout the system. This leads to safer and more reliable installations.

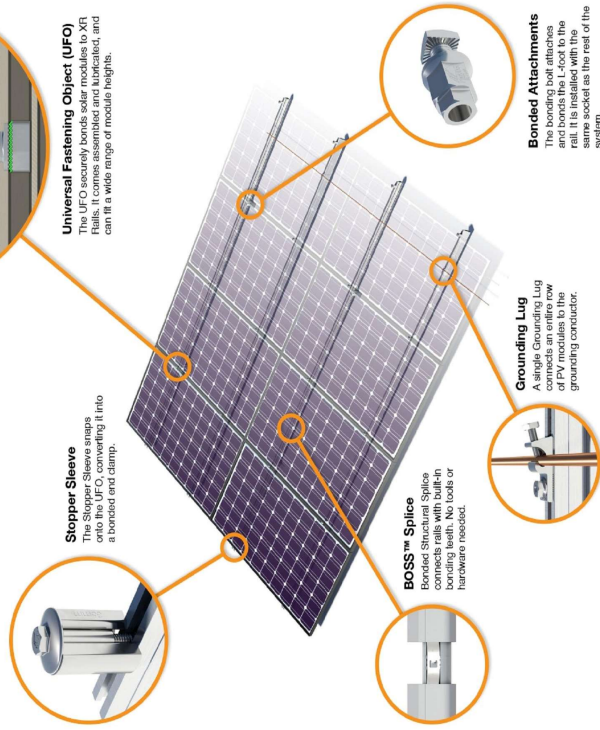

System Diagram

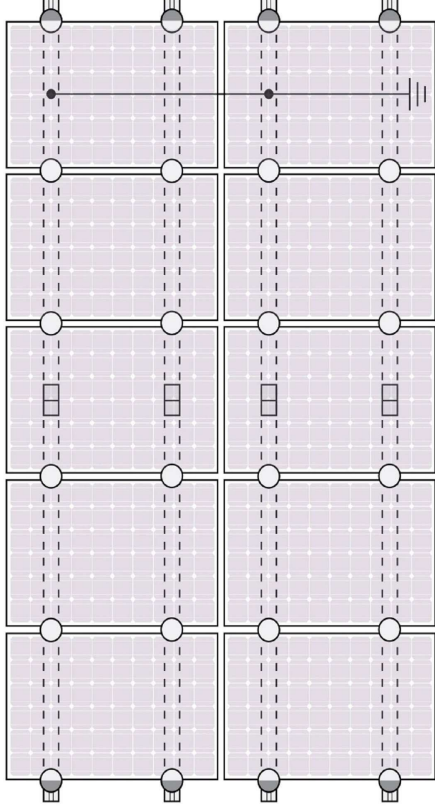

○ UFO ◐ Stopper Sleeve ● Grounding Lug ◻ BOSS™ Splice ≡ Ground Wire

Approved Enphase microinverters can provide equipment grounding of IronRidge systems, eliminating the need for grounding lugs and field installed equipment ground conductors (EGC). A minimum of two microinverters mounted to the same rail and connected to the same Enphase cable is required. Refer to installation manuals for additional details.

UL Certification

The IronRidge Flush Mount, Tilt Mount, and Ground Mount Systems have been listed to UL 2703 by Intertek Group plc.

UL 2703 is the standard for evaluating solar mounting systems. It ensures these devices will maintain strong electrical and mechanical connections over an extended period of time in extreme outdoor environments.

Go to IronRidge.com/UFO

Feature	Cross-System Compatibility		
	Flush Mount	Tilt Mount	Ground Mount
XR Rails	✓	✓	XR1000 Only
UFO/Stopper	✓	✓	✓
BOSS™ Splice	✓	✓	N/A
Grounding Lugs	1 per Row	1 per Row	1 per Array
Microinverters & Power Optimizers	Compatible with most MLPE manufacturers. Refer to system installation manual.		
Fire Rating	Class A	Class A	N/A
Modules	Tested or Evaluated with over 400 Framed Modules. Refer to installation manuals for a detailed list.		

032923



PROJECT: 211 CHEDWORTH DR
MUNICIPALITY: ANGIER, NC
ZIP CODE: 27501
CLIENT: MS. ERICK N DAVILA
10,935 KW DC-STC / 7,600 KW AC

AUTHOR: ----
DATE: 28/MAR/23
REV: -

A3 - BONDING AND GROUNDING SPECIFICATIONS
Need on-site installation support?
Palmetto Installation Hotline
Call or Text: 1-843-258-5389
InstallHotline@Palmetto.com

VSUN
VSUN modules with 30, 35 and 40 mm frames
VSUNxxx-Yz-aa
Where "Y" can be 60, 72, 108, 120, or 144; "z" can be M, P, MH, PH, or BWH; and "aa" can be blank, BB, BW, or DG

© 2021 IronRidge, Inc. All rights reserved. Visit www.ir-patents.com for patent information. Version 1.20

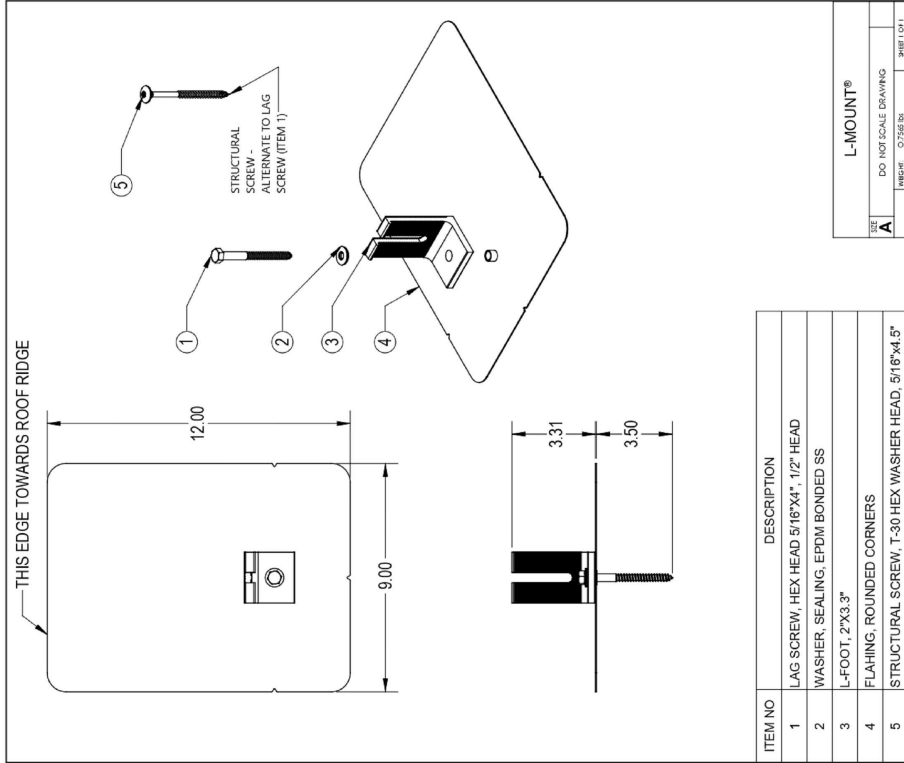

© 2022 QuickMount All rights reserved. Visit www.quickmount.com or call 1-800-227-9523 for more information.

L-Mount MNI Rev 1.12

L-Mount® Installation Instructions

Installation Tools Required: tape measure, roofing bar, chalk line, stud finder, caulk gun, sealant compatible with roofing materials, drill with 7/32" or 1/8" bit, drill or impact gun with 1/2" socket.

WARNING: QuickMount® products are NOT designed for and should NOT be used to anchor fall protection equipment.



1. Locate, choose, and mark centers of rafters to be mounted. Select the courses of shingles where mounts will be placed.



2. Carefully lift composition roof shingle with roofing bar, just above placement of mount. Remove nails as required and backfill holes with approved material. See "Proper Flashing Placement" on next page.

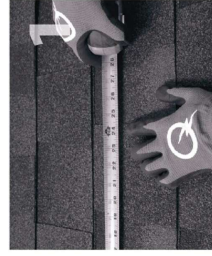

3. Clean up any sawdust, and fill hole with sealant compatible with roofing materials.



4. If attaching with lag bolt, use a 1/4" bit (Lag). Use a 3/8" bit (S1) for attaching with the structural screw. Drill pilot hole into roof and rafter, taking care to drill square to the roof. Do not use mount as a drill guide. Drill a 2" deep hole into rafter.



5. Prepare lag bolt or structural screw with sealing washer. Using a 1/2-inch socket on an impact gun, drive prepared lag bolt through L-foot until L-foot can no longer easily rotate. **DO NOT over-torque.** NOTE: Structural screw can be driven with T-30 hex head bit.



6. Place L-foot onto elevated flange and rotate L-foot to desired orientation.



7. Prepare lag bolt or structural screw with sealing washer. Using a 1/2-inch socket on an impact gun, drive prepared lag bolt through L-foot until L-foot can no longer easily rotate. **DO NOT over-torque.** NOTE: Structural screw can be driven with T-30 hex head bit.



8. You are now ready for the rock of your choice. Follow all the directions of the rock manufacturer as well as the module manufacturer. NOTE: Make sure top of L-Foot makes solid contact with racking.

All roofing manufacturers' written instructions must also be followed by anyone modifying a roof system. Consult the roof manufacturer's specs and instructions prior to working on the roof.

© 2022 QuickMount All rights reserved. Visit www.quickmount.com or call 1-800-227-9523 for more information.

L-Mount MNI Rev 1.12



A4 - MOUNTING SPECIFICATIONS

Need on-site installation support?

Palmetto Installation Hotline
Call or Text: 1-843-258-5389
InstallHotline@Palmetto.com

AUTHOR: ----

DATE: 28/MAR/23

REV: -

PROJECT: 211 CHEDWORTH DR
MUNICIPALITY: ANGIER, NC
ZIP CODE: 27501
CLIENT: MS. ERICK N DAVILA
10.935 KW DC-STC / 7.600 KW AC

PALMETTO
PHONE: +1 843-720-1844
WWW.PALMETTO.COM



Single Phase Inverter with HD-Wave Technology for North America

SE3000H-US / SE3800H-US / SE5000H-US / SE6000H-US / SE7600H-US / SE10000H-US / SE11400H-US



Optimized installation with HD-Wave technology

- Specifically designed to work with power optimizers
- Record-breaking 99% weighted efficiency
- Quick and easy inverter commissioning directly from a smartphone using the SolarEdge Se/APP
- Fixed voltage inverter for longer strings
- Integrated arc fault protection and rapid shutdown for NEC 2014, NEC 2017 and NEC 2020 per article 690.11 and 690.12
- UL1741 SA certified, for CPUC Rule 21 grid compliance
- Small, lightweight, and easy to install both outdoors or indoors
- Built-in module-level monitoring
- Optional: Faster installations with built-in consumption metering (1% accuracy) and production revenue grade metering (0.5% accuracy, ANSI C12.20)

solaredge.com



Single Phase Inverter with HD-Wave Technology for North America

SE3000H-US / SE3800H-US / SE5000H-US / SE6000H-US / SE7600H-US / SE10000H-US / SE11400H-US

MODEL NUMBER	SE3000H-US	SE3800H-US	SE5000H-US	SE6000H-US	SE7600H-US	SE10000H-US	SE11400H-US
APPLICABLE TO INVERTERS WITH PART NUMBER	SEXXXXH-AXXXX-BXX4						
OUTPUT							

Rated AC Power Output	3000	3800 @ 240V 3300 @ 208V	5000	6000 @ 240V 5000 @ 208V	7600	10000	11400 @ 240V 10000 @ 208V
Maximum AC Power Output	3000	3800 @ 240V 3300 @ 208V	5000	6000 @ 240V 5000 @ 208V	7600	10000	11400 @ 240V 10000 @ 208V
AC Output Voltage Min./Nom./Max. (21 - 240 - 264)	✓	✓	✓	✓	✓	✓	✓
AC Output Voltage Min./Nom./Max. (188 - 208 - 229)	-	✓	-	-	-	-	✓
AC Frequency (Nominal)	59.3 - 60 - 60.5°						
Maximum Continuous Output Current @240V	12.5	16	21	25	32	42	47.5
Maximum Continuous Output Current @208V	-	16	-	24	-	-	48.5
Power factor	1, Adjustable -0.85 to 0.85						
GFDI Threshold	1						
UL984 Monitoring, Identifying Protection, Country Configurable Thresholds	Yes						

INPUT								
Maximum DC Power @240V	4650	5900	7750	9300	11800	15500	17650	
Maximum DC Power @208V	-	5100	-	7750	-	-	15500	
Transformer-less, Ungrounded	Yes							
Maximum Input Voltage	480							
Normal DC Input Voltage	380							
Maximum Input Current @240V ¹⁾	8.5	10.5	13.5	16.5	20	27	30.5	
Maximum Input Current @208V ¹⁾	-	9	-	13.5	-	-	27	
Max. Input Short Circuit Current	45							
Reverse-Battery Protection	Yes							
Ground-Fault Isolation Detection	600kΩ Sensitivity							
Maximum Inverter Efficiency	99						99.2	%
CEC Weighted Efficiency	99							
Nighttime Power Consumption	< 2.5							

ADDITIONAL FEATURES	
Supported Communication Interfaces	RS-485, Ethernet, ZigBee (optional), Cellular (optional)
Revenue Grade Metering, ANSI C12.20	Optional ¹⁾
Consumption Metering	Optional ¹⁾
With the Se/APP mobile application using Built-in Wi-Fi, Access Point for Local Connection	
IEEE 1547-2018, NEC 2014, NEC 2017 and IEC 62109-1/2	Automatic Rapid Shutdown upon AC Grid Disconnect

STANDARD COMPLIANCE	
Safety	UL1741, UL1741 SA, UL9698, CSA C22.2, Canadian ARC1 (according to TLI, M-07)
Grid Connection Standards	IEEE1547, Rule 21, Rule 14, IHO
Emissions	FCC Part 15 Class B

INSTALLATION SPECIFICATIONS	
AC Output Cordset Size / AWG Range	1" Maximum / 14-4 AWG
DC Input Cordset Size / # of Straps / AWG Range	1" Maximum / 1/2 Straps / 14-6 AWG
Dimensions with Safety Switch (HxWxD)	17.7 x 14.6 x 6.8 / 4.51 x 3.73 x 1.74
Weight with Safety Switch	22 / 10
Weight with Safety Switch	25.1 / 11.4
Weight with Safety Switch	26.2 / 11.9
Weight with Safety Switch	38.8 / 17.6
Weight with Safety Switch	< 50
Operating Temperature Range	-40 to +40 / -40 to +60°
Operating Temperature Range	18 to 40 (32 to 104)°
Operating Temperature Range	18 to 40 (32 to 104)°
Operating Temperature Range	18 to 40 (32 to 104)°
Operating Temperature Range	18 to 40 (32 to 104)°

1) For power de-rating information refer to <https://www.solaredge.com/sites/default/files/temperature-clearing-table-en.pdf>

AUTHOR: ---

DATE: 28/MAR/23

REV: -

A5 - INVERTER SPECIFICATIONS

Need on-site installation support?

Palmetto Installation Hotline

Call or Text: 1-843-258-5389

InstallHotline@Palmetto.com

PROJECT: 211 CHEDWORTH DR

MUNICIPALITY: ANGIER, NC

ZIP CODE: 27501

CLIENT: MS. ERICK N DAVILA

10,935 KW DC-STC / 7,600 KW AC

PHONE: +1 843-720-1844

WWW.PALMETTO.COM



Power Optimizer

For North America

S440, S500



POWER OPTIMIZER

PV power optimization at the module level

- Specifically designed to work with SolarEdge residential inverters
- Derects abnormal PV connector behavior, preventing potential safety issues*
- Module-level voltage shutdown for installer and firefighter safety
- Superior efficiency (99.5%)
- Mitigates all types of module mismatch loss, from manufacturing tolerance to partial shading

* Expected availability in 2022

solaredge.com



PROJECT: 211 CHEDWORTH DR
MUNICIPALITY: ANGIER, NC
ZIP CODE: 27501
CLIENT: MS. ERICK N DAVILA
10,935 KW DC-STC / 7,600 KW AC

PALMETTO
PHONE: +1 843-720-1844
WWW.PALMETTO.COM

AUTHOR: ----
DATE: 28/MAR/23
REV: - -

AG - OPTIMIZERS SPECIFICATIONS
Need on-site installation support?
Palmetto Installation Hotline
Call or Text: 1-843-258-5389
InstallHotline@Palmetto.com



Power Optimizer

For North America

S440, S500

INPUT	S440	S500	Unit
Rated Input DC Power*	440	500	W
Absolute Maximum Input Voltage (Voc)	60	60	Vdc
MPIPT Operating Range	8 - 60	8 - 60	Vdc
Maximum Short Circuit Current (Isc) of Connected PV Module	14.5	15	Adc
Maximum Efficiency	99.5	99.5	%
Weighted Efficiency	99.6	99.6	%
Overvoltage Category	II	II	
OUTPUT DURING OPERATION			
Maximum Output Current	15	15	Adc
Maximum Output Voltage	60	60	Vdc
OUTPUT DURING STANDBY (POWER OPTIMIZER DISCONNECTED FROM INVERTER OR INVERTER OFF)			
Safety Output Voltage per Power Optimizer	17/01	17/01	Vdc
STANDARD COMPLIANCE			
Photovoltaic Rapid Shutdown System	NEC 2014, 2017 & 2020		
FCC	FCC Part 15 Class B, IEC60006-2, IEC61000-6-3		
Safety	IEC60950-1 (Class 1 safety), UL1741		
UL Listed	UL94 V-0, UL94 V-0, UL94 V-0		
Fire Safety	VDE-AR-E 2800-7/2-2013-05		
INSTALLATION SPECIFICATIONS			
Maximum Allowed System Voltage	600		Vdc
Dimensions (W x L x H)	129 x 133 x 30 / 5.07 x 5.02 x 1.18		mm / in
Weight (including cable)	6.55 / 1.5		g / lb
Input Connector	MC4*		
Input Wire Length	0.1 / 0.32		m / ft
Output Connector	MC4		
Output Wire Length	(+1.2, (-) 0.10 / (+) 7.54, (-) 0.32		m / ft
Operating Temperature Range**	-40 to +85		°C
Protection Rating	IP68 / NEMA6P		
RoHS	0-180		°C

* If the power of the module at STC will exceed the power optimizer rated input DC power. Modules with up to +5% power tolerance are allowed.
** For other connector types, please contact Solar Edge.
(*) For ambient temperature above +30°C / +86°F, power derating is applied. Refer to Power Optimizer Temperature Derating Technical sheet for more details.

PV System Design Using a SolarEdge Inverter	Single Phase for 120V Grid	Three Phase for 208V Grid	Three Phase for 277/480V Grid
Maximum String Length (Power Optimizers)	5440, S500	8	18
Maximum String Length (Power Optimizers)	25	10	18
Maximum Nominal Power per String (Power Optimizers)	5700 (6000 with SE7000-US-SE1800-L)	6000	12750
Maximum Nominal Power per String (Inverters only with the difference in connected power between strings is 1.00kw or less)	Refer to Footnote 5	One string 7200	15000
Maximum Number of Strings per Inverter	16	Two strings or more 1800	16

1) For 3000W and 3600W inverters, the maximum number of strings per inverter is limited by the inverter's maximum input DC power. Refer to the inverter's datasheet for more details.
2) If the inverter's rated AC power is greater than the maximum power per string, then the maximum power per string will be able to reach up to the inverter's maximum input DC power. Refer to the inverter's datasheet for more details.
3) For 3000W and 3600W inverters, the maximum number of strings per inverter is limited by the inverter's maximum input DC power. Refer to the inverter's datasheet for more details.
4) If the inverter's rated AC power is greater than the maximum power per string, then the maximum power per string will be able to reach up to the inverter's maximum input DC power. Refer to the inverter's datasheet for more details.
5) If the inverter's rated AC power is greater than the maximum power per string, then the maximum power per string will be able to reach up to the inverter's maximum input DC power. Refer to the inverter's datasheet for more details.

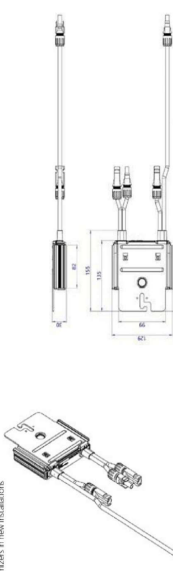

© SolarEdge Technologies, Inc. All rights reserved. SOLAREDGE, the SolarEdge logo, OPTIMIZED BY SOLAREDGE are trademarks or registered trademarks of SolarEdge Technologies, Inc. All other trademarks mentioned herein are trademarks of their respective owners. Date: May 11, 2023 (S440/S500). Subject to change without notice.

