

**ARRAY DETAILS:**

MOUNTING PLANE:	AZIMUTH:	TILT:
MP1	160°	34°
MP2	70°	34°

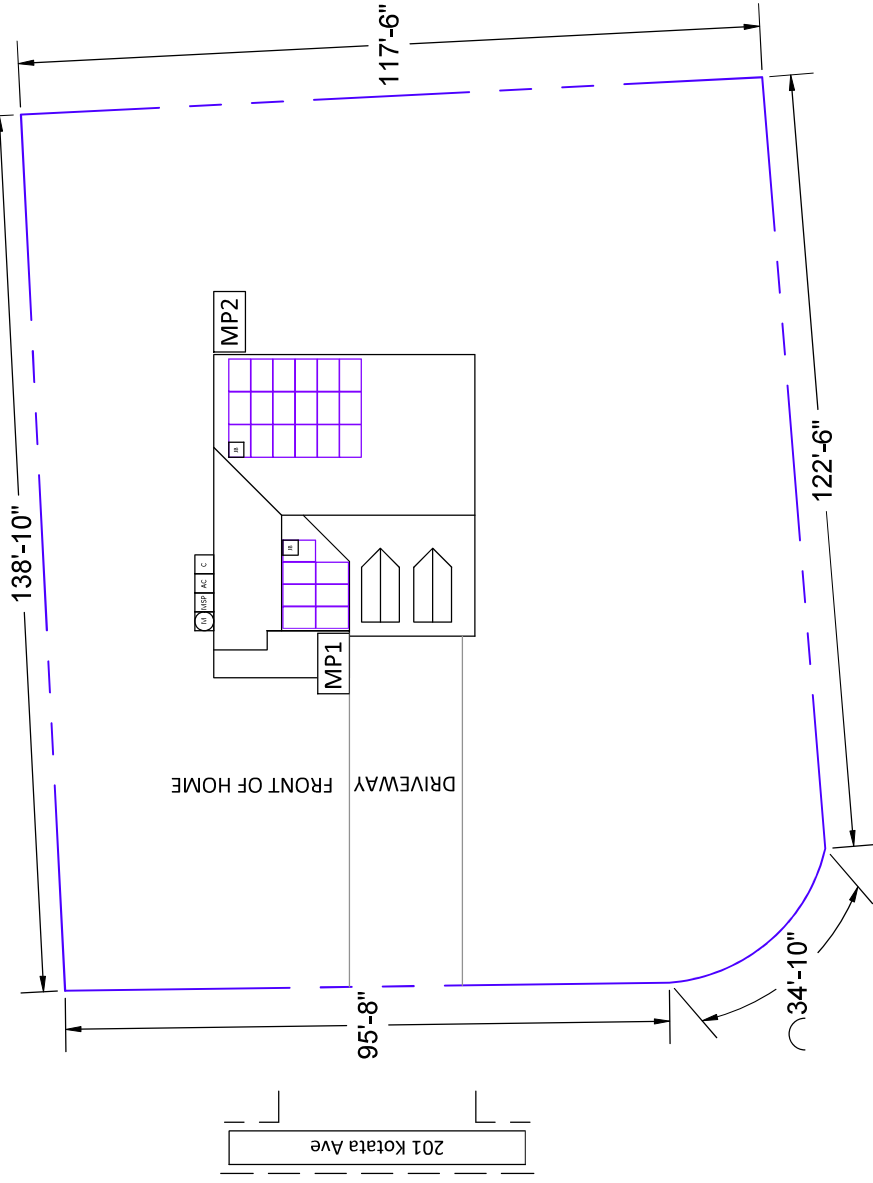

**CONTRACTOR INFORMATION:**  
 ENCOR SOLAR, LLC  
 3049 Executive Parkway  
 Suite 300  
 Lehi, UT 84043  
 License # U.35743

**SITE INFORMATION**

**CODY HUGHES**  
 201 KOTATA AVE  
 BUNNLEVEL, NC 28323  
 AC SYSTEM SIZE: 8.725 KW AC  
 DC SYSTEM SIZE: 10 KW DC  
 LAT. 35.3167369  
 LONG. -78.7496355  
 (25) HANWHHA Q.PEAK DUO BLK.ML-G10.400  
 PV MODULES  
 (25) ENPHASE IQ8A-72-2-US INVERTER(S)

DUKE ENERGY PROGRESS NC

DRAWN BY: SOLCAD  
 1/6/2023  
 SITE PLAN - PV02

VISIBLE, LOCKABLE, LABELED AC DISCONNECT LOCATED WITHIN 10' OF UTILITY METER

**EQUIPMENT LEGEND:**

- UTILITY METER
- MAIN SERVICE PANEL
- AC DISCONNECT
- METER SOCKET (FOR UTILITY PV METER)
- INVERTER
- COMBINER BOX
- SUB PANEL
- LOAD CENTER
- SERVICE DISCONNECT
- BATTERY(IES)
- PV MODULES
- JUNCTION BOX
- FIRE ACCESS PATHWAY (3 TYP)
- PROPERTY LINE

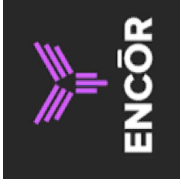
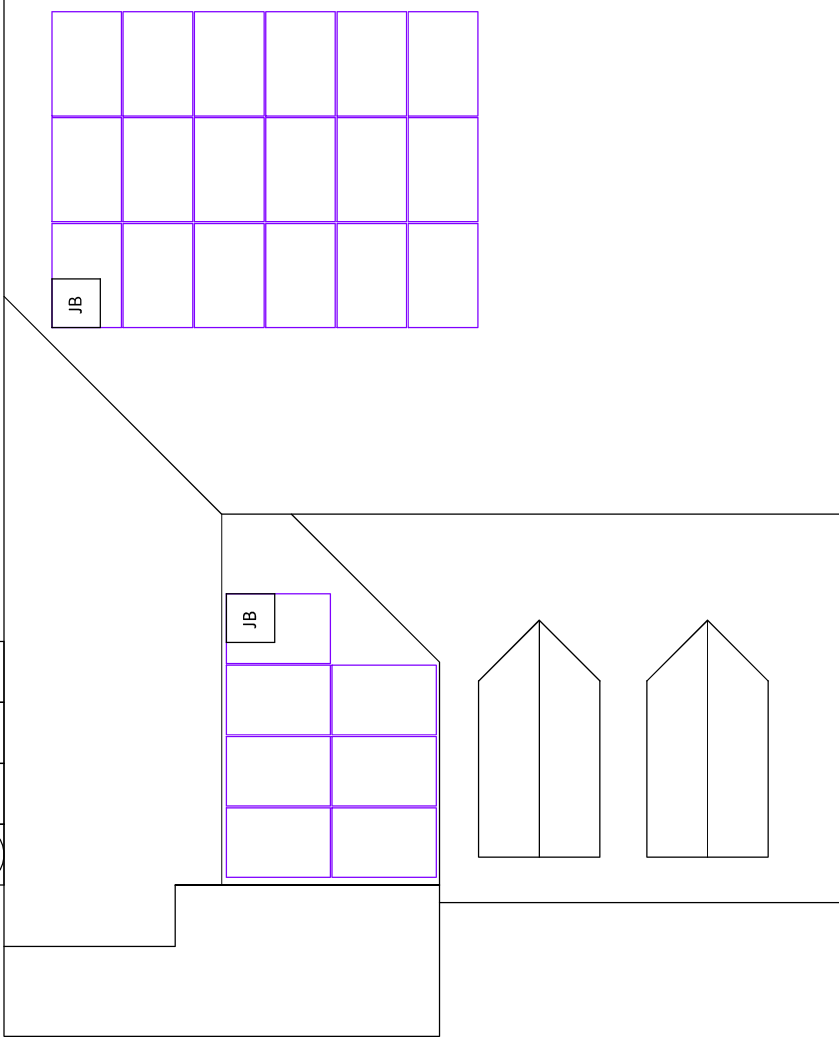
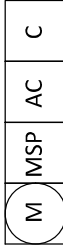
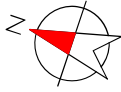

**CONTRACTOR INFORMATION:**  
 ENCOR SOLAR, LLC  
 3049 Executive Parkway  
 Suite 300  
 Lehi, UT 84043  
 License # U.35743

**SITE INFORMATION**

**CODY HUGHES**  
 201 KOTATA AVE  
 BUNNLEVEL, NC 28323  
 AC SYSTEM SIZE: 8.725 KW AC  
 DC SYSTEM SIZE: 10 KW DC  
 LAT. 35.3167369  
 LONG. -78.7496355  
 (25) HANWHHA Q, PEAK DUO BLK ML-G10 400  
 PV MODULES  
 (25) ENPHASE IQ8A-72-2-US INVERTER(S)

DUKE ENERGY PROGRESS NC

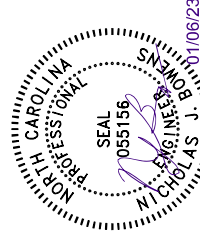

DRAWN BY: SolCAD  
 1/6/2023

ROOF PLAN - PV03

EQUIPMENT INFORMATION:		ROOF INFO:		PHOTOVOLTAIC ARRAY STRUCTURAL CRITERIA:	
RAIL MANUFACTURER:	SNAPRACK	ROOF TYPE:	ASPHALT SHINGLE	PV MODULE COUNT:	25
RAIL PART NUMBER:	STANDARD RAIL	ROOF FRAMING:	MANUFACTURED TRUSS	ARRAY AREA:	MODULE COUNT * 21.14 FT <sup>2</sup> = 528.5
ATTACHMENTS	UNIRAC - FLASHKIT PRO	RAFTER/TOP CHORD SIZE:	2x6	ROOF AREA:	1983 FT <sup>2</sup>
ATTACHMENT QTY:	50	RAFTER/TOP CHORD SPACING:	24"	PERCENT OF ROOF COVERED:	27%
SPICE QTY:	6	ATTACHMENT SPACING:	48"	ARRAY WEIGHT:	MODULE COUNT * 49 LBS = 1225 LBS
MIDCLAMP QTY:	40			POINT LOAD:	ARRAY LBS/ATTACHMENTS = 24.5
ENDCLAMP QTY:	20			DISTRIBUTED LOAD: (lbs/ft <sup>2</sup> )	ARRAY WEIGHT/AREA = 2.32 LBS/FT <sup>2</sup>

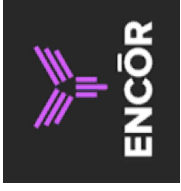

**CONTRACTOR INFORMATION:**  
**ENCOR SOLAR, LLC**  
 3049 Executive Parkway  
 Suite 300  
 Lehi, UT 84043  
 License # U.35743

**SITE INFORMATION**

**CODY HUGHES**  
 201 KOTATA AVE  
 BUNNLEVEL, NC 28323  
 AC SYSTEM SIZE: 8.725 KW AC  
 DC SYSTEM SIZE: 10 KW DC  
 LAT. 35.3167369  
 LONG. -78.7496555  
 (25) HANWHA Q.PEAK DUO BLK.ML-G10.400  
 PV MODULES  
 (25) ENPHASE IQ8A-72-2-US INVERTER(S)

DUKE ENERGY PROGRESS INC



DRAWN BY: SolCAD

1/6/2023

MOUNTING DETAIL - PV04

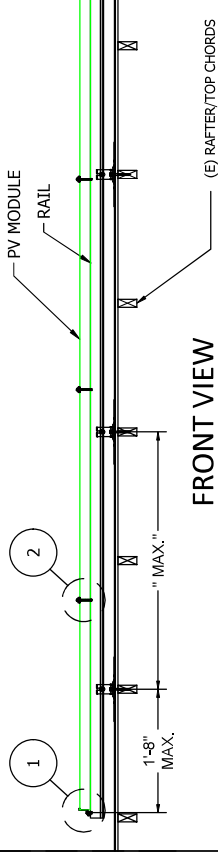

**FRONT VIEW**

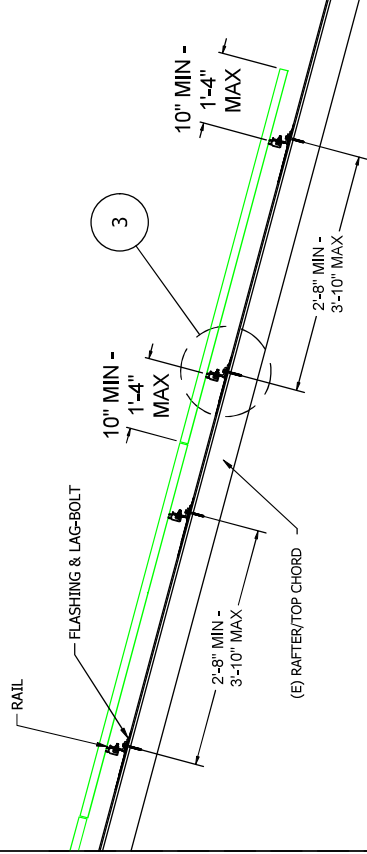

**SIDE VIEW**

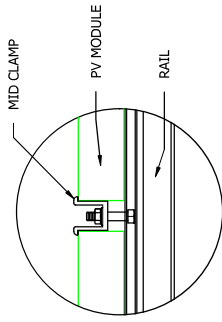

**1** END CLAMP DETAILS

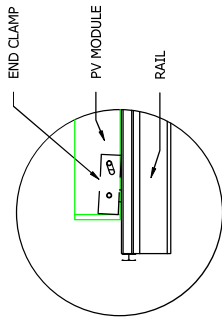

**2** MID CLAMP DETAILS

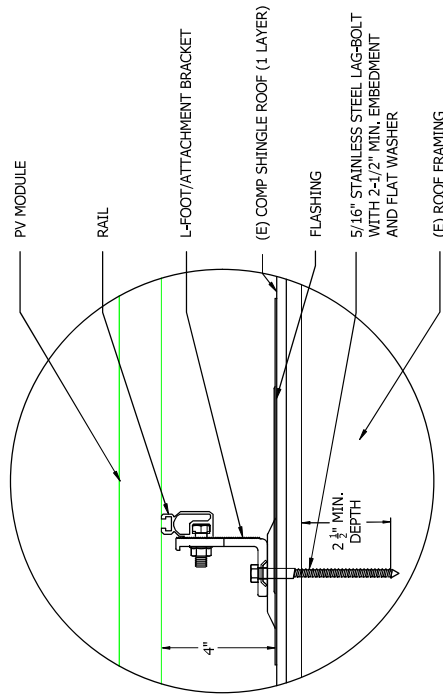

**3** DETAIL, MOUNTING AND FLASHING

EQUIPMENT INFORMATION:		ROOF INFO:		PHOTOVOLTAIC ARRAY STRUCTURAL CRITERIA:	
RAIL MANUFACTURER:	SNAPRACK	ROOF TYPE:	ASPHALT SHINGLE	PV MODULE COUNT:	25
RAIL PART NUMBER:	STANDARD RAIL	ROOF FRAMING:	MANUFACTURED TRUSS	ARRAY AREA:	MODULE COUNT * 21.14 FT <sup>2</sup> = 528.5
ATTACHMENTS:	UNIRAC - FLASHKIT PRO	RAFTER/TOP CHORD SIZE:	2x6	ROOF AREA:	1983 FT <sup>2</sup>
ATTACHMENT QTY:	50	RAFTER/TOP CHORD SPACING:	24"	PERCENT OF ROOF COVERED:	27%
SPICE QTY:	6	ATTACHMENT SPACING:	48"	ARRAY WEIGHT:	MODULE COUNT * 49 LBS = 1225 LBS
MIDCLAMP QTY:	40			POINT LOAD:	ARRAY LBS/ATTACHMENTS = 24.5
ENDCLAMP QTY:	20			DISTRIBUTED LOAD: (lbs/ft <sup>2</sup> )	ARRAY WEIGHT/AREA = 2.32 LBS/FT <sup>2</sup>

HANWHHA Q PEAK DUO BLK ML-G10-400 SPECS	
POWER MAX (P <sub>MAX</sub> ):	400 W
OPEN CIRCUIT VOLTAGE (V <sub>OC</sub> ):	45.3 V
MAX POWER-POINT CURRENT (I <sub>MP</sub> ):	10.77 A
MAX POWER-POINT VOLTAGE (V <sub>MP</sub> ):	37.13 V
SHORT CIRCUIT CURRENT (I <sub>SC</sub> ):	11.14 A
SERIES FUSE RATINGS:	20 A

ENPHASE IQ8A-72-2-US SPECS	
MAX INPUT VOLTAGE:	60 V
MAX DC SHORT CIRCUIT CURRENT:	15 A
MAXIMUM OUTPUT POWER:	340 W
MAXIMUM OUTPUT CURRENT:	1.45 A
NOML OUTPUT VOLTAGE:	240 V
MAX UNITS PER 20A CIRCUIT:	11
3-PHASE, 60 HZ, UL 1741, LISTED	

EQUIPMENT SCHEDULE			
TYPE	QTY	DESCRIPTION	RATING
MODULES:	(25)	HANWHHA Q PEAK DUO BLK ML-G10-400	400 W
INVERTERS:	(25)	ENPHASE IQ8A-72-2-US	340 W
AC DISCONNECT(S):	(1)	PV AC DISCONNECT, 240V, 2-POLE	60A
AC COMBINER:	(1)	ENPHASE (X-IQ-AM 1-240-4)	125 A

CONDUIT & CONDUCTOR SCHEDULE				
TAG	QTY	WIRE GAUGE	DESCRIPTION	CONDUIT SIZE
1	(2)	12-2	ENPHASE Q-CABLE ALUMINUM - (L1, L2)	N/A - FREE AIR
	(1)	6 AWG	BARE COPPER - (GROUND)	
2	(2)	10 AWG	THHN/THWN-2 COPPER - (L1, L2)	
	(1)	10 AWG	THHN/THWN-2 COPPER - (GROUND)	3/4" EMT
3	(6)	10 AWG	THHN/THWN-2 (L1, L2)	
	(1)	10 AWG	THHN/THWN-2 COPPER - (GROUND)	3/4" EMT
4	(3)	6 AWG	THWN-2 COPPER - (L1, L2, NEUTRAL)	
	(1)	8 AWG	THWN-2 COPPER - (GROUND)	3/4" EMT

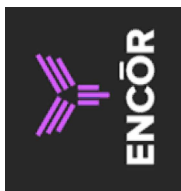

**CONTRACTOR INFORMATION:**  
**ENCOR SOLAR, LLC**  
 3049 Executive Parkway  
 Suite 300  
 Lehi, UT 84043  
 License # U.35743

**SITE INFORMATION**

**CODY HUGHES**  
 201 KOTATA AVE  
 BUNNLEVEL, NC 28323  
 AC SYSTEM SIZE: 8.725 KW AC  
 DC SYSTEM SIZE: 10 KW DC  
 LAT, 35.3167369  
 LONG, -78.7496355  
 (25) HANWHHA Q PEAK DUO BLK ML-G10-400 PV MODULES  
 (25) ENPHASE IQ8A-72-2-US INVERTER(S)

DUKE ENERGY PROGRESS NC

DRAWN BY: SOLCAD  
 1/6/2023  
 LINE DIAGRAM - PV05

VISIBLE, LOCKABLE,  
 LABELED AC DISCONNECT  
 LOCATED WITHIN 10'  
 OF UTILITY METER

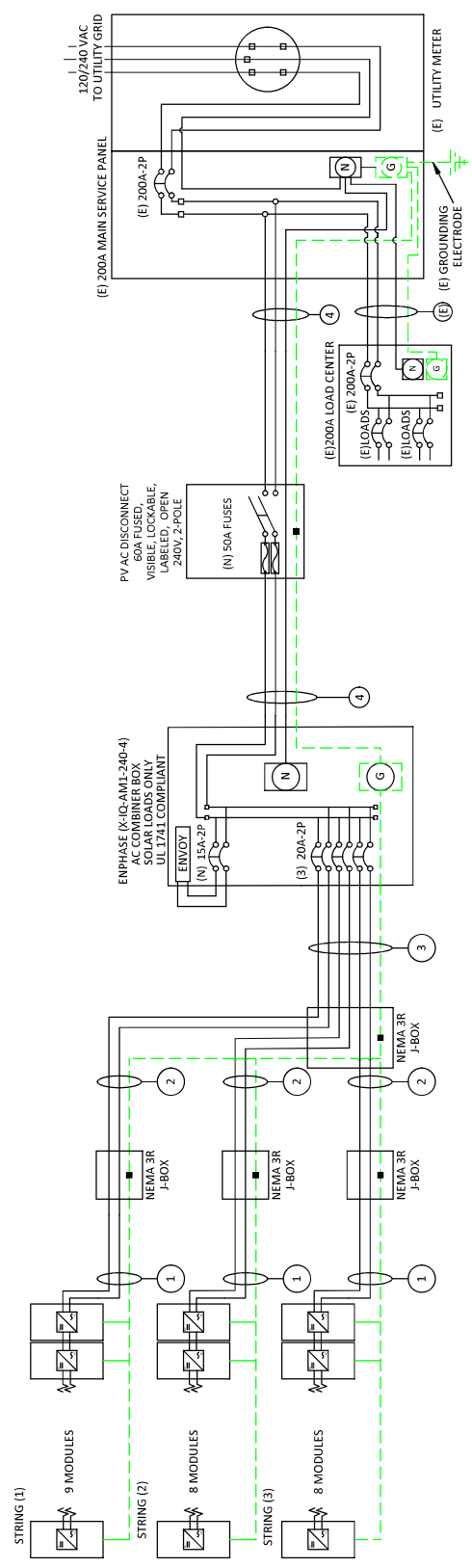

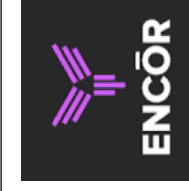

**CONTRACTOR INFORMATION:**  
**ENCOR SOLAR, LLC**  
 3049 Executive Parkway  
 Suite 300  
 Lehi, UT 84043  
 License # U.35743

**SITE INFORMATION**

**CODY HUGHES**  
 201 KOTATA AVE  
 BUNNLEVEL, NC 28323  
 AC SYSTEM SIZE: 8.725 KW AC  
 DC SYSTEM SIZE: 10 KW DC  
 LAT: 35.3167369  
 LONG: -78.7496355  
 (25) HANWHHA Q-PEAK DUO BLK ML-G10-400  
 PV MODULES  
 (25) ENPHASE IQ8A-72-2-US INVERTER(S)

DUKE ENERGY PROGRESS NC

DRAWN BY: SOLCAD  
 1/6/2023  
 ELECTRICAL CALCS - PV06

STRING CALCULATIONS		SYSTEM OCPD CALCULATIONS	
ENPHASE IQ8A-72-2-US	STRING #1	STRING #2	STRING #3
MAX AC CURRENT:	13.05A	11.60A	11.60A
MICRO INVERTERS IN SERIES:	9	8	8
NOMINAL STRING VOLTAGE:	240V	240V	240V
MAX AC OUTPUT POWER:	3141W	2792W	2792W
ARRAY DC POWER:	10000W		
TOTAL MAX AC CURRENT:	36.25A		
INVERTER MODEL(S): ENPHASE IQ8A-72-2-US			
# OF INVERTERS: 25			
MAX OUTPUT CURRENT: 1.45A			
( # OF INVERTERS ) X ( MAX OUTPUT CURRENT ) X 125% <= OCPD RATING			
( 25 X 1.45A X 1.25 ) = 45.3125A <= 50A, OK			
LOAD SIDE INTERCONNECTION			
MAIN BUSBAR RATING: 200A			
MAIN DISCONNECT RATING: 200A			
PV OCPD RATING: 50A			
SERVICE RATING >= PV OCPD			
200A >= 50A, OK			

**CONDUIT & CONDUCTOR SCHEDULE**

TAG	QTY	WIRE GAUGE	DESCRIPTION	CONDUIT SIZE	CONDUCTOR RATING	CONDUCTOR TEMP. RATE	AMBIENT TEMP	TEMP. DERATE	# OF CONDUCTORS DERATE	CONDUCTOR RATING W/DERATES	CONDUIT FILL
1	(2)	12-2	ENPHASE Q-CABLE ALUMINUM - (L1, L2)	N/A - FREE AIR	25A	90°C	35°C	0.96	N/A - FREE AIR	24A	N/A - FREE AIR
	(1)	6 AWG	BARE COPPER - (GROUND)								
2	(2)	10 AWG	THHN/THWN-2 COPPER - (L1, L2)	3/4" EMT	40A	90°C	35°C	0.96	1	38.4A	11.9%
	(1)	10 AWG	THWN-2 COPPER - (GROUND)								
3	(6)	10 AWG	THHN/THWN-2 (L1, L2)	3/4" EMT	40A	90°C	35°C	0.96	0.8	30.72A	27.8%
	(1)	10 AWG	THWN-2 COPPER - (GROUND)								
4	(3)	6 AWG	THWN-2 COPPER - (L1, L2, NEUTRAL)	3/4" EMT	65A	75°C	35°C	0.94	1	61.1A	35.5%
	(1)	8 AWG	THWN-2 COPPER - (GROUND)								

**GROUNDING & GENERAL NOTES:**

- PV INVERTER IS UNGROUNDED, TRANSFORMER-LESS TYPE.
- DC GEC AND AC EGC TO BE SPLICED TO EXISTING ELECTRODE
- ANY EXISTING WIRING INVOLVED WITH PV SYSTEM CONNECTION THAT IS FOUND TO BE INADEQUATE PER CODE SHALL BE CORRECTED PRIOR TO FINAL INSPECTION.
- JUNCTION BOX QUANTITIES, AND PLACEMENT SUBJECT TO CHANGE IN THE FIELD - JUNCTION BOXES DEPICTED ON ELECTRICAL DIAGRAM REPRESENT WIRE TYPE TRANSITIONS.
- AC DISCONNECT NOTED IN EQUIPMENT SCHEDULE OPTIONAL IF OTHER AC DISCONNECTING MEANS IS LOCATED WITHIN 10' OF SERVICE DISCONNECT.

**INTERCONNECTION NOTES:**

- INTERCONNECTION SIZING, LIMITATIONS AND COMPLIANCE DETERMINED IN ACCORDANCE WITH [NEC 705.12].
- GROUND FAULT PROTECTION IN ACCORDANCE WITH [NEC 215.9], [NEC 230.95] AND [NEC 690.41]
- ALL EQUIPMENT TO BE RATED FOR BACKFEEDING.

**DISCONNECT NOTES:**

- DISCONNECTING SWITCHES SHALL BE WIRED SUCH THAT WHEN THE SWITCH IS OPENED THE CONDUCTORS REMAINING LIVE ARE CONNECTED TO THE TERMINALS MARKED "LINE SIDE" (TYPICALLY THE UPPER TERMINALS)
- AC DISCONNECT MUST BE ACCESSIBLE TO QUALIFIED UTILITY PERSONNEL, BE LOCKABLE, AND BE A VISIBLE-BREAK SWITCH
- FUSED AC DISCONNECT REQUIRED

# MAIN PHOTOVOLTAIC SYSTEM DISCONNECT

LABEL 1  
FIXED ON THE MAIN DISCONNECTING MEANS FOR THE PV SYSTEM.  
[NEC 690.13(B)]



**WARNING**  
ELECTRIC SHOCK HAZARD  
TERMINALS ON THE LINE AND  
LOAD SIDES MAY BE ENERGIZED  
IN THE OPEN POSITION

LABEL 2  
FOR PV DISCONNECTING MEANS WHERE THE LINE AND  
LOAD TERMINALS MAY BE ENERGIZED IN THE OPEN  
POSITION.  
[NEC 690.13(B)]



**WARNING**  
POWER SOURCE OUTPUT CONNECTION,  
DO NOT RELOCATE THIS OVERCURRENT DEVICE.

LABEL 3  
FIXED ADJACENT TO THE BACK-FED BREAKER FROM  
THE INVERTER IF IT CONSISTS OF LOAD SIDE  
CONNECTION TO BUSBAR.  
[NEC 705.12(B)(3)(2)]



**CAUTION**  
MULTIPLE SOURCES OF POWER

LABEL 4  
FIXED ON EQUIPMENT CONTAINING OVERCURRENT  
DEVICES IN CIRCUITS SUPPLYING POWER TO  
A BUSBAR OR CONDUCTOR SUPPLIED FROM MULTIPLE  
SOURCES.  
[NEC 705.10]



**WARNING**  
THIS EQUIPMENT IS FED BY MULTIPLE  
SOURCES. TOTAL RATING OF ALL  
OVERCURRENT DEVICES, EXCLUDING  
MAIN SUPPLY OVERCURRENT  
DEVICE, SHALL NOT EXCEED  
AMPACITY OF BUSBAR.

LABEL 5  
EQUIPMENT CONTAINING OVERCURRENT  
DEVICES IN CIRCUITS SUPPLYING POWER TO A  
BUSBAR OR CONDUCTOR SUPPLIED FROM  
MULTIPLE SOURCES SHALL BE MARKED TO  
INDICATE THE PRESENCE OF ALL SOURCES.[NEC  
705.12(B)(5)]

# PHOTOVOLTAIC AC DISCONNECT

RATED AC OUTPUT CURRENT: **36**  
NOMINAL OPERATING AC VOLTAGE: **240**

LABEL 6  
MARKED AT AC DISCONNECTING MEANS.  
[NEC 690.54]

# PHOTOVOLTAIC POWER SOURCE

## SOLAR PV SYSTEM EQUIPPED WITH RAPID SHUTDOWN

TURN RAPID SHUTDOWN SWITCH TO THE "OFF" POSITION TO SHUT DOWN PV SYSTEM AND REDUCE SHOCK HAZARD IN ARRAY

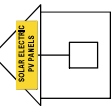

LABEL 7  
AT DIRECT-CURRENT EXPOSED RACEWAYS, CABLE TRAYS, COVERS AND AT MAXIMUM 10 FT SECTION OR WHERE SEPARATED BY ENCLOSURES, WALLS, PARTITIONS, CEILINGS, OR FLOORS.  
[NEC 690.31(D)(2)]

LABEL 8  
FOR PV SYSTEMS THAT SHUT DOWN THE ARRAY AND CONDUCTORS LEAVING THE ARRAY:  
SIGN TO BE LOCATED ON OR NO MORE THAN 3 FT AWAY FROM SERVICE DISCONNECTING MEANS TO WHICH THE PV SYSTEMS ARE CONNECTED AND SHALL INDICATE THE LOCATION OF ALL IDENTIFIED RAPID SHUTDOWN SWITCHES IF NOT AT THE SAME LOCATION.  
[NEC 690.56(C)(1)]

# RAPID SHUTDOWN SWITCH FOR SOLAR PV SYSTEM

LABEL 9  
SIGN LOCATED ON OR NO MORE THAN 3 FT FROM INITIATION DEVICE  
[NEC 690.56(C)(2)]

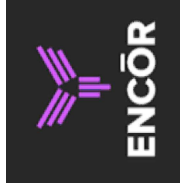

**CONTRACTOR INFORMATION:**  
ENCOR SOLAR, LLC  
3049 Executive Parkway  
Suite 300  
Lehi, UT 84043  
License # U.35743

### SITE INFORMATION

**CODY HUGHES**  
201 KOTATA AVE  
BUNNLEVEL, NC 28323  
AC SYSTEM SIZE: 8.725 KW AC  
DC SYSTEM SIZE: 10 KW DC  
LAT, 35.3167369  
LONG. -78.7496355  
(25) HANWHHA Q, PEAK DUO BLK, ML-G10-400  
PV MODULES  
(25) ENPHASE IQ8A-72-2-US INVERTER(S)

DUKE ENERGY PROGRESS INC

DRAWN BY: SOLCAD  
1/6/2023  
LABELS - PV07

### LABELING DIAGRAM:

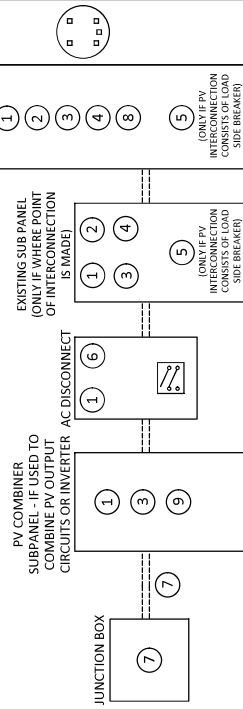

\*\* ELECTRICAL DIAGRAM SHOWN ABOVE IS FOR LABELING PURPOSES ONLY. NOT AN ACTUAL REPRESENTATION OF EQUIPMENT AND CONNECTIONS TO BE INSTALLED. LABEL LOCATIONS PRESENTED MAY VARY DEPENDING ON TYPE OF INTERCONNECTION METHOD AND LOCATION PRESENTED ELECTRICAL DIAGRAM PAGE. \*\*

- LABELING NOTES:
- LABELS CALLED OUT ACCORDING TO ALL COMMON CONFIGURATIONS. ELECTRICIAN TO DETERMINE EXACT REQUIREMENTS IN THE FIELD PER CURRENT NEC AND LOCAL CODES AND MAKE APPROPRIATE ADJUSTMENTS.
  - LABELS TO BE PERMANENTLY BASED ON THE 2020 NATIONAL ELECTRIC CODE, OSHA STANDARD 1910.146, ANSI Z535.
  - MATERIAL BASED ON THE REQUIREMENTS OF THE AUTHORITY HAVING JURISDICTION.
  - LABELS TO BE OF SUFFICIENT DURABILITY TO WITHSTAND THE ENVIRONMENT INVOLVED [NEC 110.21]
  - LABELS TO BE A MINIMUM LETTER HEIGHT OF 3/8", WHITE ON RED BACKGROUND, REFLECTIVE, AND PERMANENTLY AFFIXED [NEC 690.31(D)(2)]

# CAUTION

POWER TO THIS BUILDING IS ALSO SUPPLIED FROM ROOF MOUNTED SOLAR ARRAYS WITH SAFETY DISCONNECTS AS SHOWN:

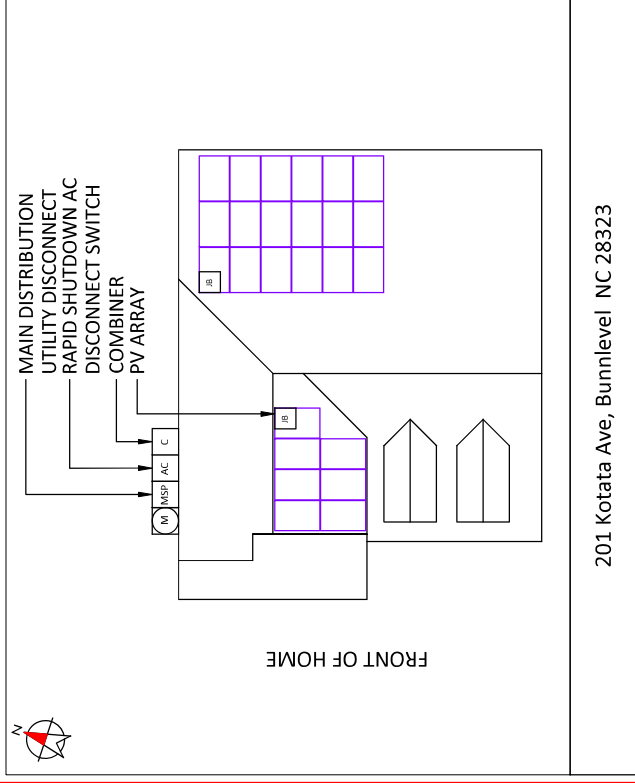

**DIRECTORY**  
PERMANENT PLAQUE OR DIRECTORY PROVIDING THE LOCATION OF THE SERVICE DISCONNECTING MEANS AND THE PHOTOVOLTAIC SYSTEM.

(ALL PLAQUES AND SIGNAGE WILL BE INSTALLED AS OUTLINED WITHIN:  
NEC 690.56(B)&(C), [NEC 705.10])



**CONTRACTOR INFORMATION:**  
ENCOR SOLAR, LLC  
3049 Executive Parkway  
Suite 300  
Lehi, UT 84043  
License # U.35743

### SITE INFORMATION

**CODY HUGHES**  
201 KOTATA AVE  
BUNNLEVEL, NC 28323  
AC SYSTEM SIZE: 8.725 KW AC  
DC SYSTEM SIZE: 10 KW DC  
LAT. 35.31677369  
LONG. -78.7496355  
(25) HANWHA Q, PEAK DUO BLK ML-G10 400  
PV MODULES  
(25) ENPHASE IQ8A-72-2-US INVERTER(S)

DUKE ENERGY PROGRESS NC

DRAWN BY: SolloCAD

1/6/2023

PLACARD - PV08

**SITE PHOTOS:**



**CONTRACTOR INFORMATION:**  
**ENCOR SOLAR, LLC**  
 3049 Executive Parkway  
 Suite 300  
 Lehi, UT 84043  
 License # U.35743

**SITE INFORMATION**

**CODY HUGHES**  
 201 KOTATA AVE  
 BUNNLEVEL, NC 28323  
 AC SYSTEM SIZE: 8.725 KW AC  
 DC SYSTEM SIZE: 10 KW DC  
 LAT. 35.3167369  
 LONG. -78.7496355  
 (25) HANWHHA Q.PEAK DUO BLK.ML-G10.400  
 PV MODULES  
 (25) ENPHASE IQBA-72-2-US INVERTER(S)

DUKE ENERGY PROGRESS INC

DRAWN BY: SOLICAD

1/6/2023

SITE PHOTOS - PV09

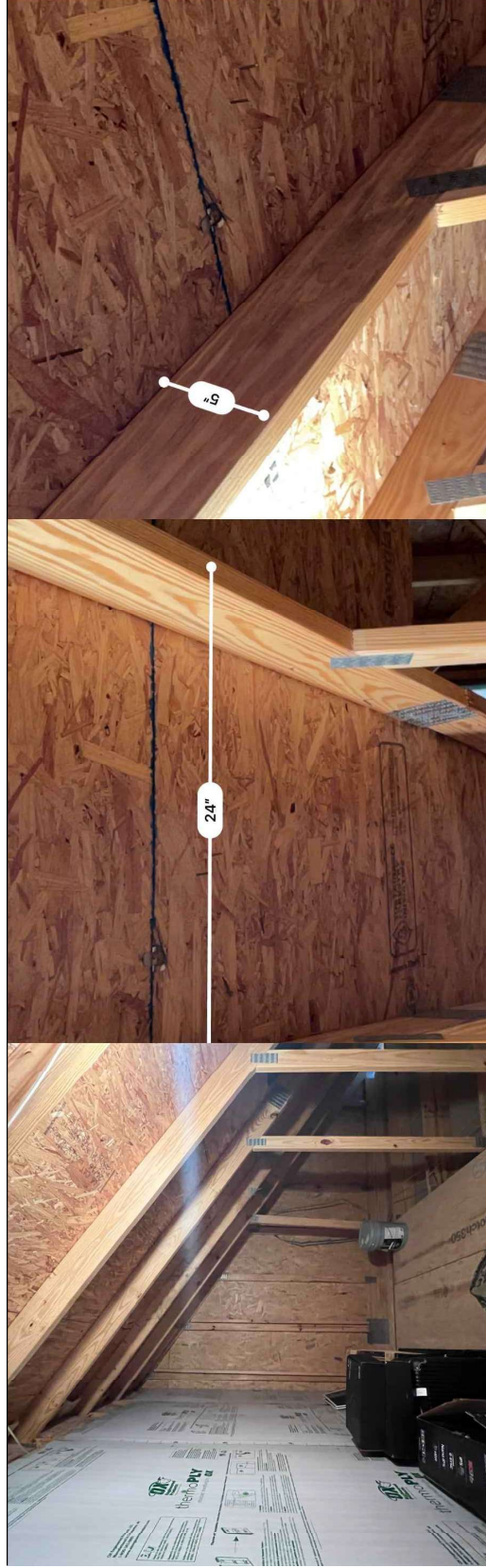



# Q.PEAK DUO BLK ML-G10

## 385-405

ENDURING HIGH PERFORMANCE



### BREAKING THE 20% EFFICIENCY BARRIER

Q.ANTUM DUO Z Technology with zero gap cell layout boosts module efficiency up to 20.9%.

### INNOVATIVE ALL-WEATHER TECHNOLOGY

Optimal yields, whatever the weather with excellent low-light and temperature behaviour.

### ENDURING HIGH PERFORMANCE

Long-term yield security with Anti LID Technology, Anti PID Technology<sup>1</sup>, Hot-Spot Protect and Traceable Quality (Tra.QM<sup>®</sup>).

### EXTREME WEATHER RATING

High-tech aluminium alloy frame, certified for high snow (5400 Pa) and wind loads (4000 Pa).

### A RELIABLE INVESTMENT

Inclusive 12-year product warranty and 25-year linear performance warranty<sup>2</sup>.

### STATE OF THE ART MODULE TECHNOLOGY

Q.ANTUM DUO combines cutting edge cell separation and innovative wiring with Q.ANTUM Technology.

<sup>1</sup> APT test conditions according to IEC/TS 62804-4:2015, method B (-500 V, 188°)

<sup>2</sup> See data sheet on rear for further information.



THE IDEAL SOLUTION FOR:



Residential analysis on residential buildings

Engineered in Germany



Engineered in Germany

### MECHANICAL SPECIFICATION

Format	1879mm x 1045mm x 32mm (including frame)
Weight	22.0 kg
Front Cover	3.2mm thermally pre-stressed glass with anti-reflection technology
Back Cover	Composite film
Frame	Black anodised aluminium
Cell	6 x 22 monocrystalline Q.ANTUM solar half cells
Junction box	59x101 mm x 32x60 mm x 15x18 mm
Cable	4mm <sup>2</sup> Solar cable, (7) ≥1200mm, (4) ≥1200mm
Connector	Stäubli MC4, Hanwha Q CELLS HQCA-IP68

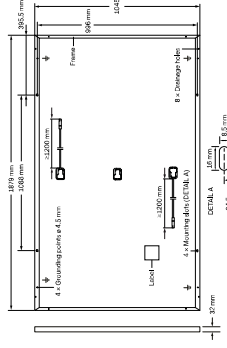

### ELECTRICAL CHARACTERISTICS

POWER CLASS	385	390	395	400	405
MINIMUM PERFORMANCE AT STANDARD TEST CONDITIONS, STC (POWER TOLERANCE ±0.5W / -0.0V)					
Power at MPP <sup>1</sup>	P <sub>MPP</sub> [W]	390	395	400	405
Short Circuit Current <sup>1</sup>	I <sub>sc</sub> [A]	11.04	11.07	11.14	11.17
Open Circuit Voltage <sup>1</sup>	V <sub>oc</sub> [V]	45.19	45.27	45.30	45.34
Current at MPP	I <sub>MPP</sub> [A]	10.59	10.65	10.71	10.77
Voltage at MPP	V <sub>MPP</sub> [V]	36.36	36.62	36.68	37.13
Efficiency <sup>1</sup>	η [%]	≥19.6	≥19.9	≥20.1	≥20.6
MINIMUM PERFORMANCE AT NORMAL OPERATING CONDITIONS, NIMOT <sup>2</sup> :					
Power at MPP	P <sub>MPP</sub> [W]	288.8	292.6	296.3	300.1
Short Circuit Current	I <sub>sc</sub> [A]	8.90	8.92	8.95	8.97
Open Circuit Voltage	V <sub>oc</sub> [V]	42.62	42.65	42.69	42.72
Current at MPP	I <sub>MPP</sub> [A]	8.35	8.41	8.46	8.51
Voltage at MPP	V <sub>MPP</sub> [V]	34.59	34.81	35.03	35.25
Tolerances: tolerance P <sub>MPP</sub> ±3%, I <sub>sc</sub> , V <sub>oc</sub> ±5% at STC; 1000W/m <sup>2</sup> , 25.2°C, AM 1.5 according to IEC 61604-3 + 800W/m <sup>2</sup> , NIMOT, spectrum AM 1.5					
<b>Q CELLS PERFORMANCE WARRANTY</b>					
At least 98% of nominal power during first year. Thereafter max. 0.5% degradation per year. At least 93.5% of nominal power after 25 years. At least 96% of nominal power up to 25 years.					
All data within measurement tolerance. All data are based on the data with the warranty terms of the Q CELLS sales organisation of your respective country.					

### PERFORMANCE AT LOW IRRADIANCE

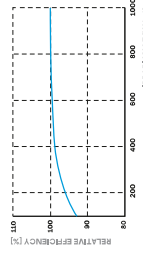

Typical module performance under low irradiance conditions in comparison to STC conditions (5°C, 1000 W/m<sup>2</sup>).

### TEMPERATURE COEFFICIENTS

Temperature Coefficient of I <sub>sc</sub>	α [%/K]	+0.04	Temperature Coefficient of V <sub>oc</sub>	β [%/K]	-0.27
Temperature Coefficient of P <sub>MPP</sub>	γ [%/K]	-0.34	Nominal Module Operating Temperature	NMOT [°C]	43±3

### PROPERTIES FOR SYSTEM DESIGN

Maximum System Voltage	V <sub>MPP</sub> [V]	1000	PV module classification	Class II
Maximum Reverse Current	I <sub>r</sub> [A]	20	Fire Rating based on ANSI/UL 61730	C / TYPE 2
Max. Design Load, Push/Pull	[Pa]	3600/2860	Permitted Module Temperature on Continuous Duty	-40°C - +85°C
Max. Test Load, Push/Pull	[Pa]	5400/4000		

### QUALIFICATIONS AND CERTIFICATES



Note: Installation instructions must be followed. See the installation and operating manual or contact our technical service department for further information on approved installation and use of this product.

Hanwha Q CELLS GmbH  
Sonnenallee 17-21, 06766 Bitterfeld-Wolfen, Germany | TEL +49 (0)3494 66 99-23444 | FAX +49 (0)3494 66 99-23000 | EMAIL sales@q-cells.com | WEB www.q-cells.com



Engineered in Germany



DATA SHEET



## IQ8 Series Microinverters

Our newest IQ8 Microinverters are the industry's first microgrid-forming, software-defined microinverters with split-phase power conversion capability to convert DC power to AC power efficiently. The brain of the semiconductor-based microinverter is our proprietary application-specific integrated circuit (ASIC) which enables the microinverter to operate in grid-tied or off-grid modes. This chip is built in advanced 55nm technology with high speed digital logic and has super-fast response times to changing loads and grid events, alleviating constraints on battery sizing for home energy systems.



Part of the Enphase Energy System, IQ8 Series Microinverters integrate with the Enphase IQ Gateway to provide real-time Enphase App monitoring and analysis software.



IQ8 Series Microinverters redefine reliability standards with more than one million hours of testing and an industry-leading limited warranty of up to 25 years.



IQ8 Series Microinverters are UL Listed as PV Rapid Shut Down Equipment and conform with various regulations, when installed according to manufacturer's instructions.



Connect PV modules quickly and easily to IQ8 Series Microinverters using the included O-COC-2 adapter cable with plug-in-play MC4 connectors.

© 2021 Enphase Energy. All rights reserved. Enphase, the Enphase logo, IQ8 microinverters, and other names are trademarks of Enphase Energy, Inc. Data subject to change.

IQ8SE-D5-0001-01-EN-US-2021-01-09

## IQ8 Series Microinverters

INPUT DATA (DC)	IQ8-01-2-US	IQ8-02-2-US	IQ8-03-2-US	IQ8-04-2-US	IQ8-05-2-US	IQ8-06-2-US	IQ8-07-2-US	IQ8-08-2-US	IQ8-09-2-US	IQ8-10-2-US	IQ8-11-2-US	IQ8-12-2-US	IQ8-13-2-US	IQ8-14-2-US	IQ8-15-2-US	IQ8-16-2-US	IQ8-17-2-US	IQ8-18-2-US	IQ8-19-2-US	IQ8-20-2-US
Commonly used module pairings <sup>1</sup>	235 - 350	260 - 460	285 - 480	310 - 500	335 - 540	360 - 560	385 - 580	410 - 600	435 - 620	460 - 640	485 - 660	510 - 680	535 - 700	560 - 720	585 - 740	610 - 760	635 - 780	660 - 800	685 - 820	710 - 840
Module compatibility	60-cell/120 half-cell																			
MPP1 voltage range	V	27 - 37	28 - 45	33 - 45	38 - 45	38 - 45	38 - 45	38 - 45	38 - 45	38 - 45	38 - 45	38 - 45	38 - 45	38 - 45	38 - 45	38 - 45	38 - 45	38 - 45	38 - 45	38 - 45
Operating range	V	25 - 48	25 - 48	25 - 48	25 - 48	25 - 48	25 - 48	25 - 48	25 - 48	25 - 48	25 - 48	25 - 48	25 - 48	25 - 48	25 - 48	25 - 48	25 - 48	25 - 48	25 - 48	25 - 48
Min/max start voltage	V	30 / 46	30 / 46	30 / 46	30 / 46	30 / 46	30 / 46	30 / 46	30 / 46	30 / 46	30 / 46	30 / 46	30 / 46	30 / 46	30 / 46	30 / 46	30 / 46	30 / 46	30 / 46	30 / 46
Max input DC voltage	V	50	50	50	50	50	50	50	50	50	50	50	50	50	50	50	50	50	50	50
Max DC current <sup>2</sup> (module I <sub>sc</sub> )	A	15	15	15	15	15	15	15	15	15	15	15	15	15	15	15	15	15	15	15
Overvoltage class DC port	mk	II	II	II	II	II	II	II	II	II	II	II	II	II	II	II	II	II	II	II
DC port backfeed current	mA	0	0	0	0	0	0	0	0	0	0	0	0	0	0	0	0	0	0	0
DC port configuration	1x1 Ungrounded array; No additional DC side protection required; AC side protection requires max 20A per branch circuit																			
OUTPUT DATA (AC)	IQ8-01-2-US	IQ8-02-2-US	IQ8-03-2-US	IQ8-04-2-US	IQ8-05-2-US	IQ8-06-2-US	IQ8-07-2-US	IQ8-08-2-US	IQ8-09-2-US	IQ8-10-2-US	IQ8-11-2-US	IQ8-12-2-US	IQ8-13-2-US	IQ8-14-2-US	IQ8-15-2-US	IQ8-16-2-US	IQ8-17-2-US	IQ8-18-2-US	IQ8-19-2-US	IQ8-20-2-US
Peak output power	VA	245	300	330	366	384	384	384	384	384	384	384	384	384	384	384	384	384	384	384
Max continuous output power	VA	240	280	325	349	360	360	360	360	360	360	360	360	360	360	360	360	360	360	360
Nominal (L-L) voltage/range <sup>3</sup>	V	240 / 211 - 264	240 / 211 - 264	240 / 211 - 264	240 / 211 - 264	240 / 211 - 264	240 / 211 - 264	240 / 211 - 264	240 / 211 - 264	240 / 211 - 264	240 / 211 - 264	240 / 211 - 264	240 / 211 - 264	240 / 211 - 264	240 / 211 - 264	240 / 211 - 264	240 / 211 - 264	240 / 211 - 264	240 / 211 - 264	240 / 211 - 264
Max continuous output current	A	1.0	1.21	1.35	1.45	1.58	1.58	1.58	1.58	1.58	1.58	1.58	1.58	1.58	1.58	1.58	1.58	1.58	1.58	1.58
Nominal frequency	Hz	60	60	60	60	60	60	60	60	60	60	60	60	60	60	60	60	60	60	60
Extended frequency range	Hz	50 - 68	50 - 68	50 - 68	50 - 68	50 - 68	50 - 68	50 - 68	50 - 68	50 - 68	50 - 68	50 - 68	50 - 68	50 - 68	50 - 68	50 - 68	50 - 68	50 - 68	50 - 68	50 - 68
Max units per 20 A (L-L) branch circuit <sup>4</sup>		16	13	11	11	11	11	11	11	11	11	11	11	11	11	11	11	11	11	11
Total harmonic distortion	%	<5%	<5%	<5%	<5%	<5%	<5%	<5%	<5%	<5%	<5%	<5%	<5%	<5%	<5%	<5%	<5%	<5%	<5%	<5%
Overvoltage class AC port	mk	III	III	III	III	III	III	III	III	III	III	III	III	III	III	III	III	III	III	III
AC port backfeed current	mA	30	30	30	30	30	30	30	30	30	30	30	30	30	30	30	30	30	30	30
Power factor setting		1.0	1.0	1.0	1.0	1.0	1.0	1.0	1.0	1.0	1.0	1.0	1.0	1.0	1.0	1.0	1.0	1.0	1.0	1.0
Grid-tied power factor (adjustable)		0.85 leading - 0.85 lagging	0.85 leading - 0.85 lagging	0.85 leading - 0.85 lagging	0.85 leading - 0.85 lagging	0.85 leading - 0.85 lagging	0.85 leading - 0.85 lagging	0.85 leading - 0.85 lagging	0.85 leading - 0.85 lagging	0.85 leading - 0.85 lagging	0.85 leading - 0.85 lagging	0.85 leading - 0.85 lagging	0.85 leading - 0.85 lagging	0.85 leading - 0.85 lagging	0.85 leading - 0.85 lagging	0.85 leading - 0.85 lagging	0.85 leading - 0.85 lagging	0.85 leading - 0.85 lagging	0.85 leading - 0.85 lagging	0.85 leading - 0.85 lagging
Peak efficiency	%	97.5	97.6	97.6	97.6	97.5	97.5	97.5	97.5	97.5	97.5	97.5	97.5	97.5	97.5	97.5	97.5	97.5	97.5	97.4
CEC weighted efficiency	%	97	97	97	97.5	97	97	97	97	97	97	97	97	97	97	97	97	97	97	97
Night-time power consumption	mW	60	60	60	60	60	60	60	60	60	60	60	60	60	60	60	60	60	60	60
<b>TECHNICAL DATA</b>																				
Ambient temperature range	-40°C to +60°C (-40°F to +140°F)																			
Relative humidity range	4% to 100% (condensing)																			
DC Connector Type	MC4																			
Dimensions (HxWxD)	212 mm (8.3") x 175 mm (6.9") x 30.2 mm (1.2")																			
Weight	1.08 kg (2.38 lbs)																			
Coating	Natural connection - no fans																			
Approved for wet locations	Yes																			
Acoustic noise at 1m	<69 dBA																			
Pollution degree	PD3																			
Enclosure	Class II double-insulated, corrosion resistant polymer enclosure																			
Environ. category / UV exposure rating	NEMA Type 6 / outdoor																			
<b>COMPLIANCE</b>																				
Certifications	CA Rule 21 (UL 1741-SA), UL 62095-1, UL1741/IEEE1547, FCC Part 15 Class B, ICES-0003, Class E, CAN/CSA-C22.2 NO.107-01 This product is UL Listed as PV Rapid Shut Down Equipment and conforms with NEC 2014, NEC 2017, and NEC 2020 section 690.12 and C221-1-008 Rule 64-218 Rapid Shutdown of PV Systems, for AC and DC conductors, when installed according to manufacturer's instructions.																			

(1) The IQ8-008 variant will be operating in grid-tied mode only at 200V AC. (2) No enforced DC/AC ratio. See the compatibility calculator at <https://fni.enphase.com/module-compatibility>. (3) Maximum continuous input DC current is 1.6A. (4) Nominal voltage range can be extended beyond nominal if required by the utility. (5) Units may vary; refer to local requirements to define the number of microinverters per branch in your area.

IQ8SE-D5-0001-01-EN-US-2021-01-09

# Enphase IQ Combiner 4/4C

X-IQ-AM1-240-4  
X-IQ-AM1-240-4C



To learn more about Enphase offerings, visit [enphase.com](http://enphase.com)

The **Enphase IQ Combiner 4/4C** with Enphase IQ Gateway and integrated LTE-M1 cell modem (included only with IQ Combiner 4C) consolidates interconnection equipment into a single enclosure and streamlines IQ microinverters and storage installations by providing a consistent, pre-wired solution for residential applications. It offers up to four 2-pole input circuits and Eaton BR series busbar assembly.

### Smart

- Includes IQ Gateway for communication and control
- Includes Enphase Mobile Connect cellular modem (CELLMODEM-M1-06-SP-05), included only with IQ Combiner 4C
- Includes solar shield to match Enphase IQ Battery aesthetics and deflect heat
- Flexible networking supports Wi-Fi, Ethernet, or cellular
- Optional AC receptacle available for PLC bridge
- Provides production metering and consumption monitoring

### Simple

- Centered mounting brackets support single stud mounting
- Supports bottom, back and side conduit entry
- Up to four 2-pole branch circuits for 240 VAC plug-in breakers (not included)
- 60A total PV or storage branch circuits

### Reliable

- Durable NRTL-certified NEMA type 3R enclosure
- Five-year limited warranty
- Two years labor reimbursement program coverage included for both the IQ Combiner SKUs
- UL listed



## Enphase IQ Combiner 4/4C

### MODEL NUMBER

IQ Combiner 4 (X-IQ-AM1-240-4)

IQ Combiner 4C (X-IQ-AM1-240-4C)

### ACCESSORIES AND REPLACEMENT PARTS

(not included, order separately)

- Ensemble Communications Kit
- COMMS-CELLMODEM-M1-06
- CELLMODEM-M1-06-SP-05
- CELLMODEM-M1-06-AT-05
- Circuit Breakers
- Supports Eaton BR10, BR215, BR220, BR230, BR240, BR250, and BR260 circuit breakers.
- Circuit breaker, 2 pole, 10A, Eaton BR210
- Circuit breaker, 2 pole, 15A, Eaton BR215
- Circuit breaker, 2 pole, 20A, Eaton BR220
- Circuit breaker, 2 pole, 25A, Eaton BR220B
- Circuit breaker, 2 pole, 30A, Eaton BR230B with hold down kit support
- Circuit breaker, 2 pole, 30A, Eaton BR230B with hold down kit support
- Power line carrier (communication bridge pair), quantity = one pair
- EPLC01
- XA-30LARSHELD-ES
- XAPLUG-203
- XA-ENV-PCBA-3
- XIQNA-HD-125A

### ELECTRICAL SPECIFICATIONS

Rating	Continuous duty
System voltage	120/240 VAC, 60 Hz
Eaton BR series busbar rating	125 A
Max. continuous current rating	65 A
Max. continuous current rating (input from PV/storage)	64 A
Max. fuse/circuit rating (output)	90 A
Branch circuits (solar and/or storage)	Up to four 2-pole Eaton BR series Distributed Generation (DG) breakers only (not included)
Max. total branch circuit breaker rating (input)	60A of distributed generation / 95A with IQ Gateway breaker included
Energy breaker	100- or 15A rating GE/Siemens/Eaton included
Production metering CT	200 A solid core pre-installed and wired to IQ Gateway
Consumption monitoring CT (CT-200S-SPLIT)	A pair of 200 A split core current transformers

### MECHANICAL DATA

Dimensions (WxHxD)	37.5 x 49.5 x 16.8 cm (14.75" x 19.5" x 6.63"). Height is 21.06" (53.5 cm) with mounting brackets.
Weight	7.5 kg (16.5 lbs)
Ambient temperature range	-40° C to +46° C (-40° to 115° F)
Coating	Natural convection, plus heat shield
Enclosure environmental rating	Outdoor, NRTL-certified, NEMA type 3R, polycarbonate construction
Wire sizes	<ul style="list-style-type: none"> <li>• 20 A to 50 A breaker inputs: 14 to 4 AWG copper conductors</li> <li>• 60 A breaker branch input: 4 to 1/0 AWG copper conductors</li> <li>• Main lug combined output: 10 to 2/0 AWG copper conductors</li> <li>• Neutral and ground: 14 to 1/0 copper conductors</li> <li>• Additional equipment for conductor sizing.</li> </ul>
Altitude	To 2000 meters (6560 feet)

### INTERNET CONNECTION OPTIONS

Integrated Wi-Fi	802.11n/g/n
Cellular	CELLMODEM-M1-06-SP-05, CELLMODEM-M1-06-AT-05 (4G based LTE-M1 cellular modem). Note that an Enphase Mobile Connect cellular modem is required for all Ensemble installations.
Ethernet	Optional, 802.3, Cat5E (or Cat 6) UTP Ethernet cable (not included).

### COMPLIANCE

Compliance, IQ Combiner	UL 1741, CAN/CSA C22.2 No. 1071, AET CEB Part 15, class B, FCCS 003
Compliance, IQ Gateway	UL 1741, CAN/CSA C22.2 No. 1071, AET CEB Part 15, class B, FCCS 003
Production metering	ANSI C12.20 accuracy class 0.5 (PV production)
Consumption metering	accuracy class 2.5
UL 60601-1/CAN/CSA 22.2 No. 61010-1	

To learn more about Enphase offerings, visit [enphase.com](http://enphase.com)

© 2017 Enphase Energy, Inc. All rights reserved. Enphase, Enphase logo, IQ Combiner 4/4C, and other names are trademarks of Enphase Energy, Inc. Data subject to change. 10-16-2017



## Ultra Rail



### The Ultimate Value in Rooftop Solar

 Industry leading Wire Management Solutions

 Mounts available for all roof types

 Single Tool Installation

 All SnapNrack Module Clamps & Accessories are compatible with both rail profiles

**Start Installing Ultra Rail Today**

- RESOURCES** [snapnrack.com/resources](http://snapnrack.com/resources)  
**DESIGN** [snapnrack.com/configurator](http://snapnrack.com/configurator)  
**WHERE TO BUY** [snapnrack.com/where-to-buy](http://snapnrack.com/where-to-buy)

## SnapNrack Ultra Rail System

A sleek, straightforward rail solution for mounting solar modules on all roof types. Ultra Rail features two rail profiles; UR-40 is a lightweight rail profile that is suitable for most geographic regions and maintains all the great features of SnapNrack rail, while UR-60 is a heavier duty rail profile that provides a larger rail channel and increased span capabilities. Both are compatible with all existing mounts, module clamps, and accessories for ease of install.

### The Entire System is a Snap to Install

- New Ultra Rail Mounts include snap-in brackets for attaching rail
- Compatible with all the SnapNrack Mid-Clamps and End Clamps customers love
- Universal End Clamps and snap-in End Caps provide a clean look to the array edge



### Unparalleled Wire Management

- Open rail channel provides room for running wires resulting in a long-lasting quality install
- Industry best wire management offering includes Junction Boxes, Universal Wire Clamps, MLPE Attachment Kits, and Conduit Clamps
- System is fully bonded and listed to UL 2703 Standard



### Heavy Duty UR-60 Rail

- UR-60 rail profile provides increased span capabilities for high wind speeds and snow loads
- Taller, stronger rail profile includes profile-specific rail splice and end cap
- All existing mounts, module clamps, and accessories are retained for the same great install experience



## Quality. Innovative. Superior.

SnapNrack Solar Mounting Solutions are engineered to optimize material use and labor resources and improve overall installation quality and safety.

877-732-2860 [www.snapnrack.com](http://www.snapnrack.com) [contact@snapnrack.com](mailto:contact@snapnrack.com)

© 2019 by SnapNrack Solar Mounting Solutions. All rights reserved.

# FLASHKIT PRO



FLASHKIT PRO is the complete attachment solution for composition shingle roofs. Featuring Unirac's patented SHED & SEAL technology, a weather proof system which provides the ultimate protection against roof leaks. Kitted in 10 packs for maximum convenience, flashings and hardware are available in Mill or Dark finishes. With FLASHKIT pro, you have everything you need for a quick, professional installation.



**TRUSTED WATER SEAL FLASHINGS**  
FEATURING SHED & SEAL TECHNOLOGY



**YOUR COMPLETE SOLUTION**  
Flashings, lags, continuous slot L-Feet and hardware



**CONVENIENT 10 PACKS**  
Packaged for speed and ease of handling

# FLASHKIT PRO

INSTALLATION GUIDE



FLASHKIT PRO IS THE COMPLETE FLASHING AND ATTACHMENT SOLUTION FOR COMPOSITION ROOFS.



STEP 1

STEP 2

STEP 3

INSTALL FLASHKIT PRO FLASHING

INSTALL L-FOOT

ATTACH L-FOOT TO RAIL

## PRE-INSTALL

- Locate roof rafters and snap chalk lines to mark the installation point for each roof attachment.
- Drill a 7/32" pilot hole at each roof attachment. Fill each pilot hole with sealant.

- Drive the lag bolt down until the L-foot is held firmly in place. It is normal for the EPDM on the underside of the stainless steel backed EPDM washer to compress and expand beyond the outside edge of the steel washer when the proper torque is applied.

## TIP:

- Use caution to avoid over-torquing the lag bolt if using an impact driver.
- Repeat Steps 1 and 2 at each roof attachment point.

## STEP 1 INSTALL FLASHKIT PRO FLASHING

- Add a U-shaped head of roof sealant to the underside of the flashing with the open side of the U pointing down the roof slope. Slide the aluminum flashing underneath the row of shingles directly up slope from the pilot hole as shown. Align the indicator marks on the lower end of the flashing with the chalk lines on the roof to center the raised hole in the flashing over the pilot hole in the roof. When installed correctly, the flashing will extend under the two courses of shingles above the pilot hole.

## STEP 3 ATTACH L-FOOT TO RAIL

- Insert the included 3/8" x 16 L-bolts into the lower slot on the Rail (sold separately), spacing the bolts to match the spacing between the roof attachments.
- Position the Rail against the L-Foot and insert the threaded end of the L-Bolt through the continuous slot in the L-Foot. Apply anti-seize to both threads to prevent galling of the L-bolt and included 3/8" serrated flange nut. Place the 3/8" flange nut on the L-bolt and finger tighten. Repeat STEP 3 until all L-Feet are secured to the Rail with a T-bolt. Adjust the level and height of the Rail and torque each bolt to 30ft-lbs.

## STEP 2 INSTALL L-FOOT

- Fasten L-foot and Flashing into place by passing the included lag bolt and pre-installed stainless steel-backed EPDM washer through the L-foot, EPDM grommet, and the raised hole in the flashing, into the pilot hole in the roof rafter.

# THE COMPLETE ROOF ATTACHMENT SOLUTION

FOR QUESTIONS OR CUSTOMER SERVICE VISIT UNIRAC.COM OR CALL (505) 248-2702

# FASTER INSTALLATION. 25-YEAR WARRANTY.

FOR QUESTIONS OR CUSTOMER SERVICE VISIT UNIRAC.COM OR CALL (505) 248-2702