

PROJECT DETAILS	
PV Modules	50 x SOLARIA PowerX-390R
Microinverters	50 x IQ8PLUS-72-2-US
Roof Type	Asphalt Shingles
Racking	PSR-B84 Rails (Black)
Mounting Type	CompMount Flashing (Black)
DC SIZE	19.5 kW
AC SIZE	15.0 kVA

DRAWING INDEX			
Item	Drawing #	Rev	Description
1	22598DB00-0	A	Drawing Index
2	22598DB00-1	A	Site Layout
3	22598DB00-2	A	String Mapping
4	22598DB00-3	A	Electrical One Line Diagram
5	22598DB00-4	A	Detailed Electrical Wiring Schematic
6	22598DB00-5	A	PV Labels
7	22598DB00-6	A	Bill of Materials
8	22598DB00-7	A	PV Dead Load

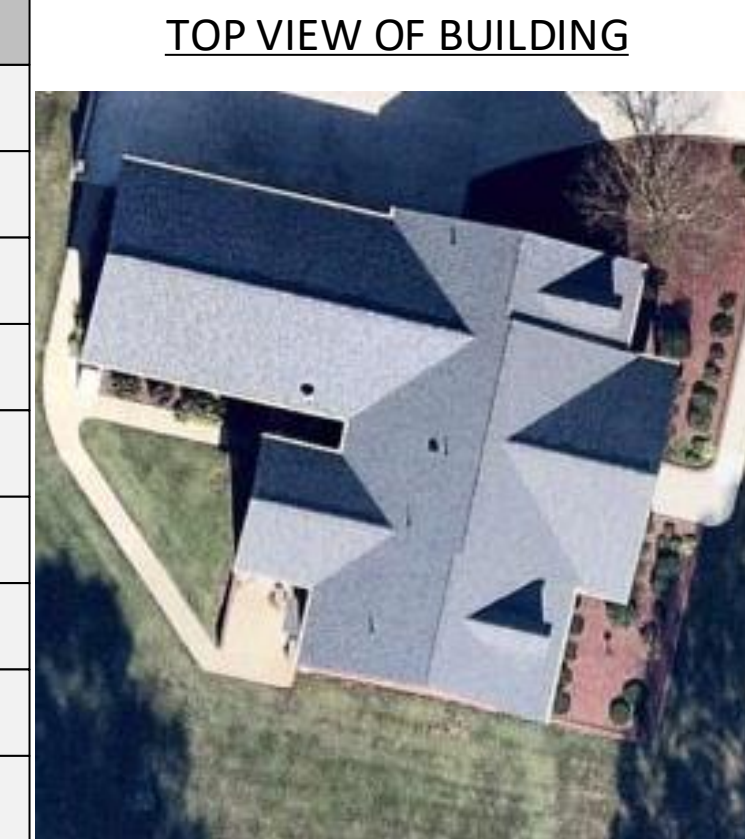

1600 Heritage Commerce Ct Ste
104, Wake Forest NC 27587
O: 919.948.6474
E: info@8msolar.com

Daniel Brown
1261 Rollins Mill Rd
Holly Springs NC 27540

PHOTOVOLTAIC NOTES

1. THE INSTALLATION OF SOLAR ARRAYS AND PHOTOVOLTAIC POWER SYSTEMS SHALL COMPLY WITH THE FOLLOWING CODES:

- 2020 NATIONAL ELECTRICAL CODE
- 2018 NORTH CAROLINA RESIDENTIAL CODE
- 2018 NORTH CAROLINA BUILDING CODE
- AS ADOPTED BY THE STATE OF NORTH CAROLINA
- ALL OTHER ORDINANCE ADOPTED BY THE LOCAL GOVERNING AGENCIES

2. ROOFTOP MOUNTED PHOTOVOLTAIC PANELS AND MODULES SHALL BE TESTED, LISTED AND IDENTIFIED BY RECOGNIZED ELECTRICAL TESTING LABORATORY.

3. SOLAR SYSTEM SHALL NOT COVER ANY PLUMBING OR MECHANICAL VENTS

4. MODULES AND SUPPORT STRUCTURES SHALL BE GROUNDED

5. SOLAR INVERTER SHALL BE LISTED TO UL1741

6. ALL CONDUCTORS SHALL BE COPPER AND SHOULD BE 75 AND 90 DEG RATED

7. REMOVAL OF AN INTERACTIVE INVERTER OR OTHER EQUIPMENT SHALL NOT DISCONNECT THE BONDING CONNECTION BETWEEN THE GROUNDING ELECTRODE CONDUCTOR AND THE PHOTOVOLTAIC SOURCE AND/OR OUTPUT CIRCUIT GROUNDED CONDUCTORS.

8. LIVE PARTS OF PV SOURCE CIRCUITS AND PV OUTPUT CIRCUITS OVER 150V TO GROUND SHALL NOT BE ACCESSIBLE TO OTHER THAN QUALIFIED PERSONS WHILE ENERGIZED.

9. ALL PV MODULES AND ASSOCIATED EQUIPMENT AND WIRING SHALL BE PROTECTED FROM PHYSICAL DAMAGE.

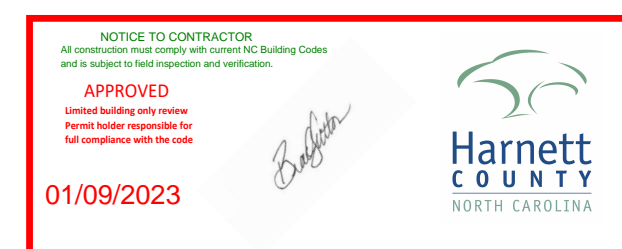

PV Installation
Professional

Ali Buttar
PVIP #031310-32

A 12/28/2022

Customer's Signature

JOB NUMBER

22-598-DB00

PROJECT STATUS

PERMITTING

SHEET

DRAWING INDEX

DB
22598DB00-0

Roofs have one layer of shingles and roofing material is asphalt shingles.

The roof is located in 115mph wind zone

Utility Meter

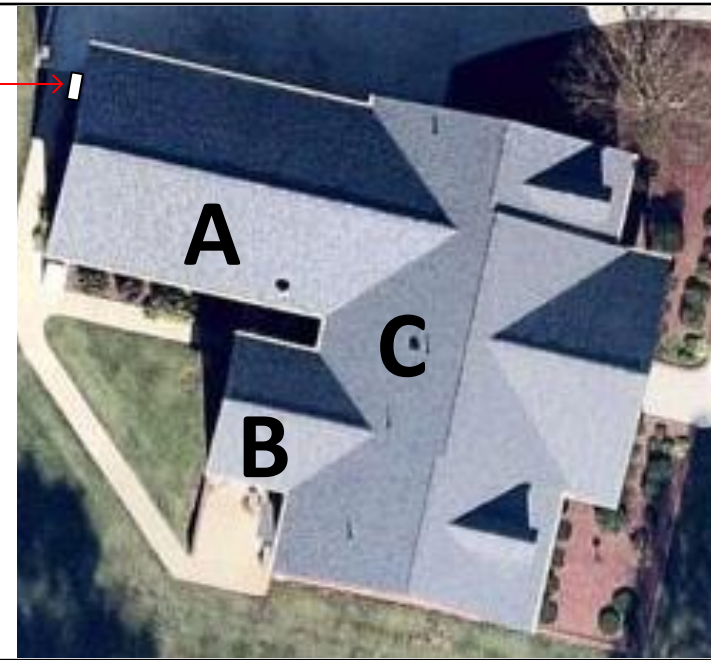

Module Dimension

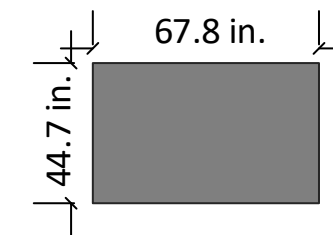

Roofs	Pitch	Azimuth
A	34°	192°
B	34°	192°
C	34°	282°



1600 Heritage Commerce Ct Ste 104, Wake Forest NC 27587
 O: 919.948.6474
 E: info@8msolar.com

SYSTEM DETAILS

NUMBER OF PANELS : 50
 PANELS MODEL : SOLARIA PowerX-390R
 DC SIZE : 19.5 KW
 AC SIZE : 15.0 KVA

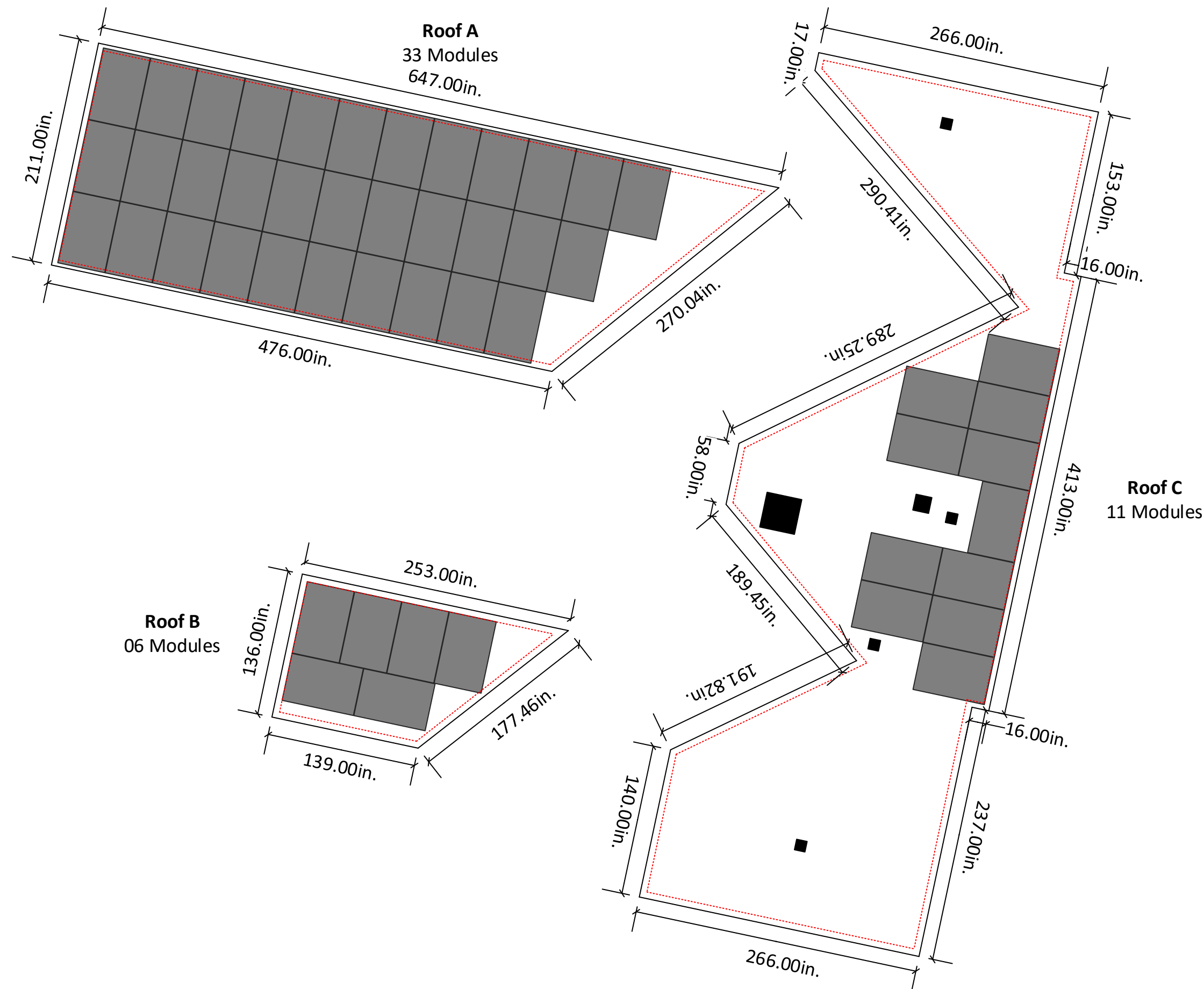

6" clearance from each side of the roof

SITE LAYOUT
 SCALE: 1/8" - 1' 0"

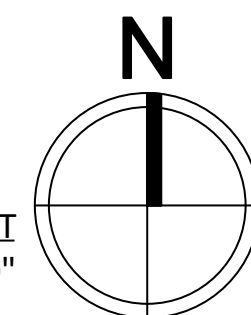

Daniel Brown
 1261 Rollins Mill Rd
 Holly Springs NC 27540



A	12/28/2022

Customer's Signature

JOB NUMBER
 22-598-DB00

PROJECT STATUS
 PERMITTING

SHEET
 SITE LAYOUT

DB
 22598DB00-1

String Layout					
Enphase IQ Combiner 4					
Strings #	No. of Modules	Color Code	Strings #	No. of Modules	Color Code
String 1	13		String 4	12	
String 2	13				
String 3	12				

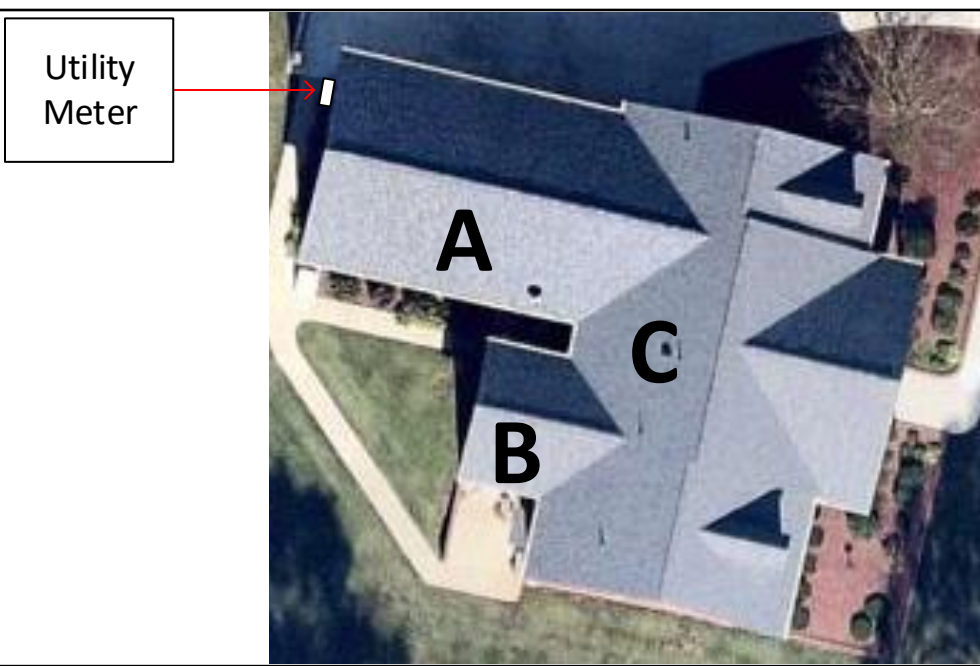

Module Dimension		
	Pitch	Azimuth
Roofs		
A	34°	192°
B	34°	192°
C	34°	282°



1600 Heritage Commerce Ct Ste 104, Wake Forest NC 27587
 O: 919.948.6474
 E: info@8msolar.com

SYSTEM DETAILS

NUMBER OF PANELS : 50
 PANELS MODEL : SOLARIA PowerX-390R
 DC SIZE : 19.5 KW
 AC SIZE : 15.0 KVA

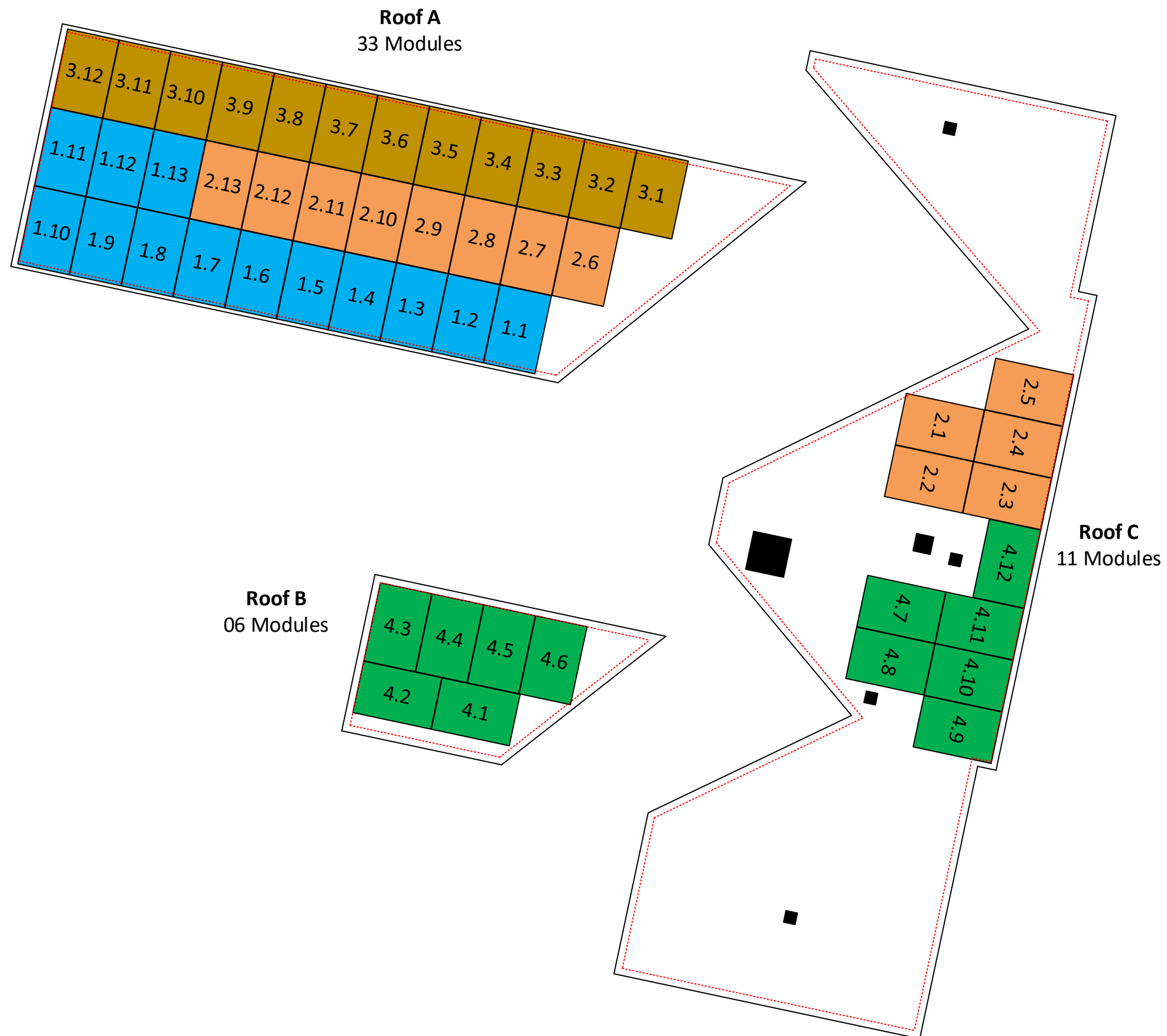

6" clearance from each side of the roof

STRING MAPPING
 SCALE: 1/8" - 1' 0"

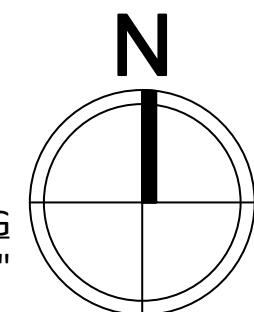

Daniel Brown
 1261 Rollins Mill Rd
 Holly Springs NC 27540



A 12/28/2022

Customer's Signature

JOB NUMBER
 22-598-DB00

PROJECT STATUS
 PERMITTING

SHEET
 STRING MAPPING

DB
 22598DB00-2



PV Installation
Professional

Ali Buttar
PVIP #031310-32

A 12/28/2022

Customer's Signature

JOB NUMBER

22-598-DB00

PROJECT STATUS

PERMITTING

SHEET

ELECTRICAL ONE LINE DIAGRAM

DB
22598DB00-3

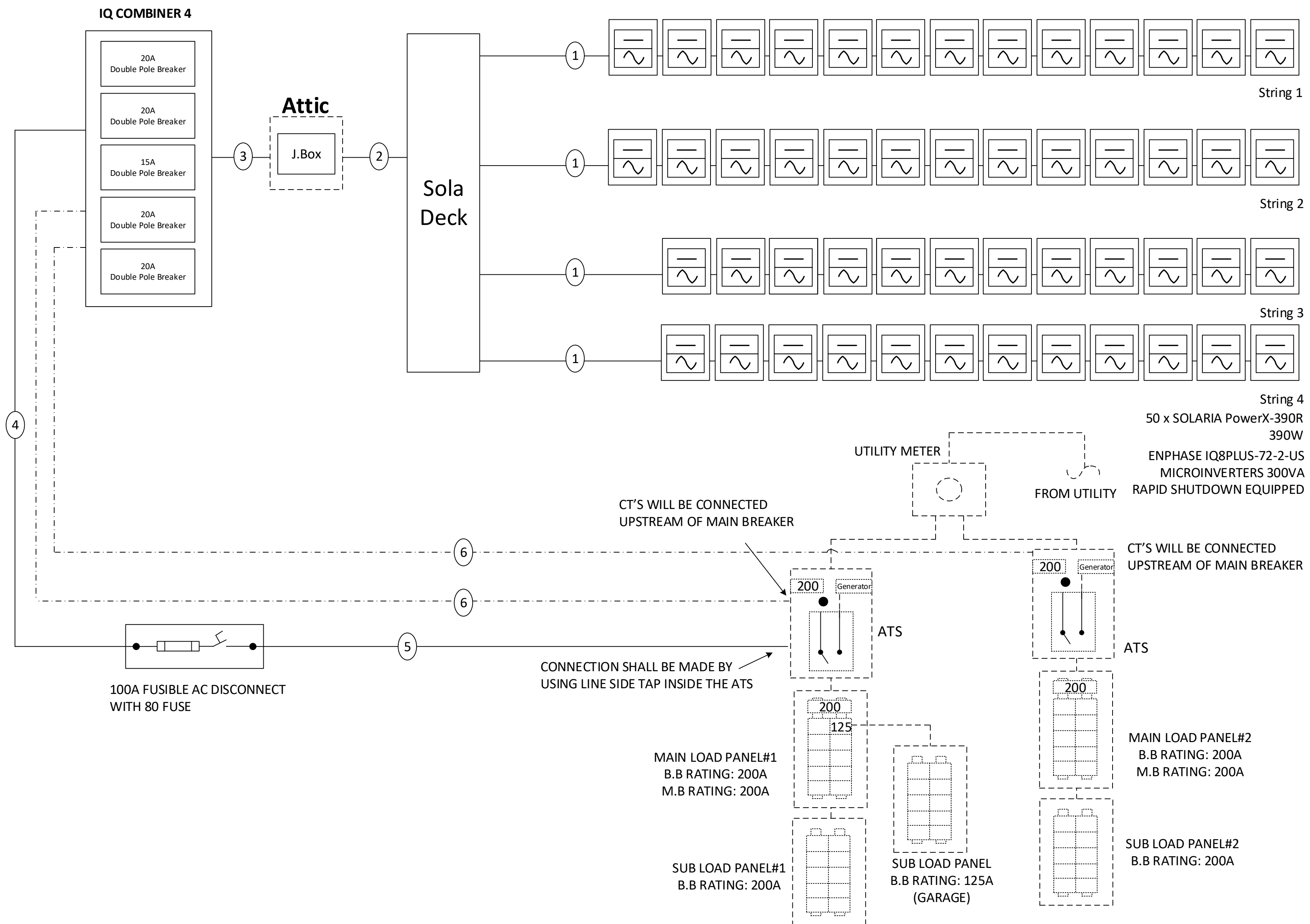

ELECTRICAL NOTES

- System Size: 19,500W DC
- (50) SOLARIA PowerX-390R
- (50) ENPHASE IQ8PLUS-72-2-US MICROINVERTERS
- Inverter Output: 1.21A max @ 240 VAC (each micro inverter)
- 300 VA AC output max (each micro inverter)
- 15.0 kVA AC output max

- Grounding will be done via Pegasus grounding lugs and mid-clamps to ensure the rail and panels are continuously grounded.
- Rapid Shutdown is included in the Micro Inverters, refer to Micro Inverter attached datasheets.
- The load center / disconnect will be visible, lockable accessible to utility linesmen and will be properly labelled as per NEC requirements. It will be located on the exterior wall of the building, next to the utility meter.

STRING 1:	STRING 2:	STRING 3:	STRING 4:
13 x 390W = 5,070W ea I _{max} (1.21 x 1.25 x 13) = 19.66 AC V _{mpp} = 240 AC V _{rise} (1.05+0.41 = 1.46) <= 2% V _{oc} <= 30 VAC	13 x 390W = 5,070W ea I _{max} (1.21 x 1.25 x 13) = 19.66 AC V _{mpp} = 240 AC V _{rise} (1.30+0.41 = 1.71) <= 2% V _{oc} <= 30 VAC	12 x 390W = 4,680W ea I _{max} (1.21 x 1.25 x 13) = 18.15 AC V _{mpp} = 240 AC V _{rise} (1.06+0.39 = 1.45) <= 2% V _{oc} <= 30 VAC	12 x 390W = 4,680W ea I _{max} (1.21 x 1.25 x 13) = 18.15 AC V _{mpp} = 240 AC V _{rise} (1.37+0.52 = 1.89) <= 2% V _{oc} <= 30 VAC

Sr.No	#Wire	Conduit Size	Ground Wire	Amperage
1	01 x #12 Q Cable		#10 Bare CU	20A
2	4 x #10 MC Cable			20A
3	8 x #10 THHN Cu	3/4" EMT	#10 Green	20A
4	3 x #04 THHN Cu	1.25" EMT	#08 Green	80A
5	3 x #04 THHN Cu	1.25" EMT		80A
6	Lead Wire 18AWG, PVC Extruded	3/4" EMT		

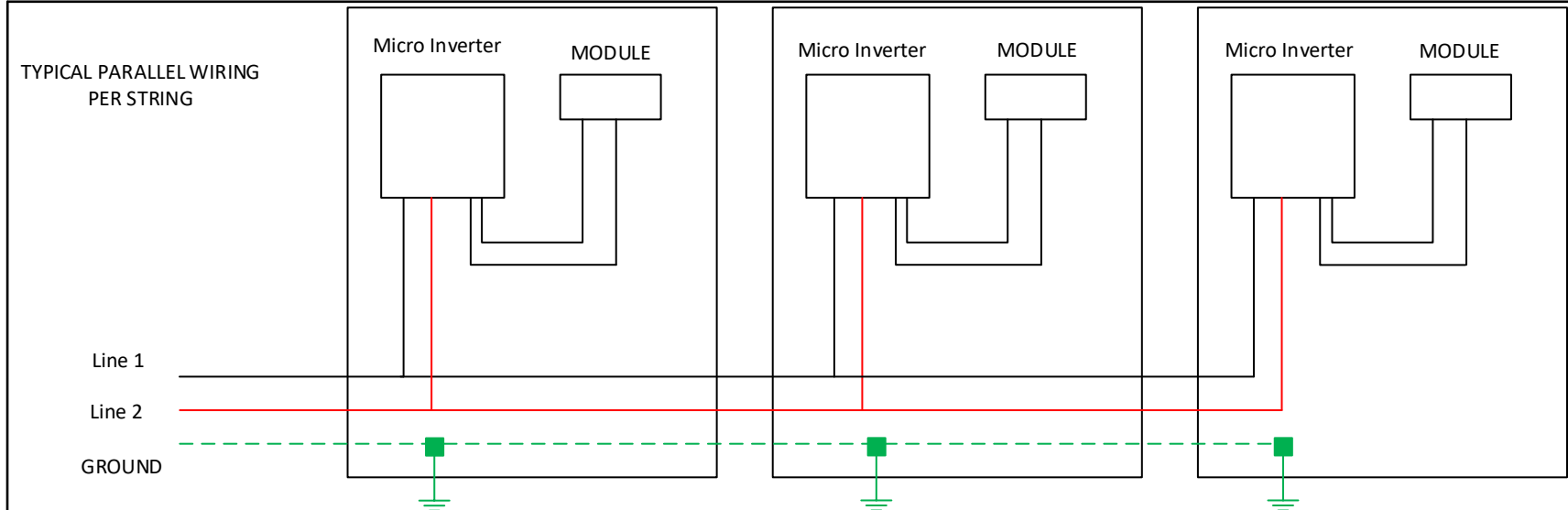

Line 1		Note: Line 1 from all strings will be passed from the production CT
Line 2		
Neutral		Note: The arrow on production CT's and consumption CT's must point towards the loads and away from the source.
Ground		

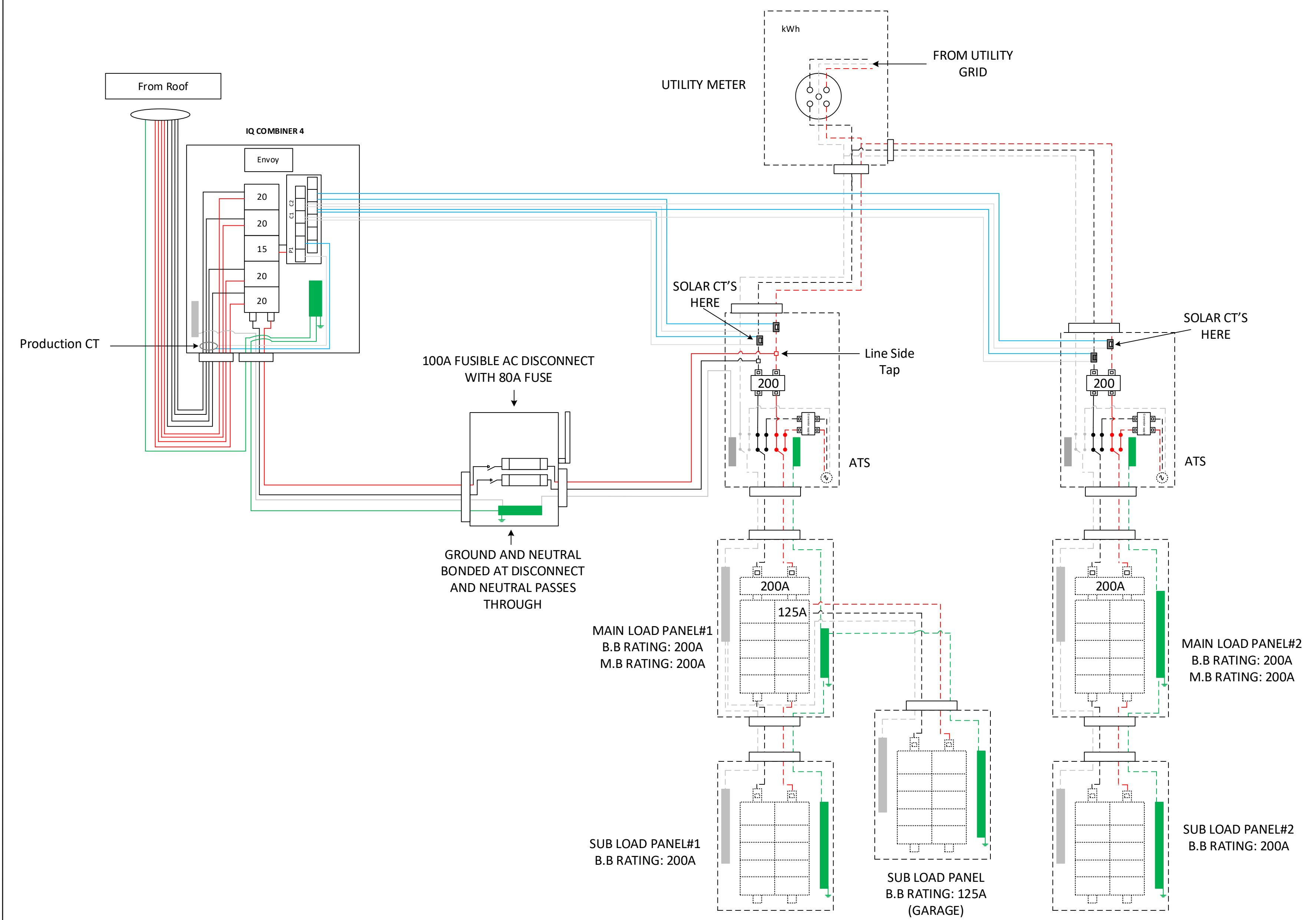

1600 Heritage Commerce Ct Ste 104, Wake Forest NC 27587
 O: 919.948.6474
 E: info@8msolar.com

Daniel Brown
 1261 Rollins Mill Rd
 Holly Springs NC 27540



A 12/28/2022

Customer's Signature

JOB NUMBER
 22-598-DB00

PROJECT STATUS
 PERMITTING

SHEET
 DETAILED ELECTRICAL DIAGRAM

DB
 22598DB00-4

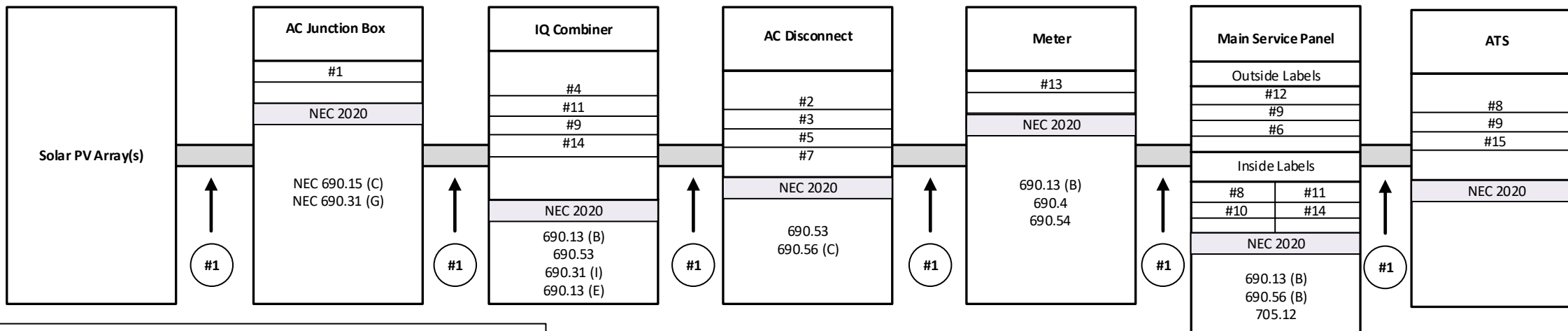

Daniel Brown
1261 Rollins Mill Rd
Holly Springs NC 27540



A 12/28/2022

Customer's Signature

JOB NUMBER 22-598-DB00

PROJECT STATUS PERMITTING

SHEET PV LABELS

DB
22598DB00-5

**LABELING AND WARNING SIGNS
NEC 2020**

A. PURPOSE

PROVIDE EMERGENCY RESPONDERS WITH APPROPRIATE WARNING AND GUIDANCE WITH RESPECT TO ISOLATING THE SOLAR ELECTRIC SYSTEM. THIS CAN FACILITATE IDENTIFYING ENERGIZED ELECTRICAL LINES THAT CONNECT THE SOLAR PANELS TO THE INVERTER, AS SHOULD NOT BE CUT WHEN VENTING FOR SMOKE REMOVAL.

B. MAIN SERVICE DISCONNECT:

1. RESIDENTIAL BUILDINGS- THE MARKING MAY BE PLACED WITHIN THE MAIN SERVICE DISCONNECT. THE MARKING SHALL BE PLACED ON THE OUTSIDE COVER IF THE MAIN SERVICE DISCONNECT IS OPERABLE WITH THE SERVICE PANEL CLOSED.

2. COMMERCIAL BUILDINGS- THE MARKINGS SHALL BE PLACED ADJACENT TO THE MAIN SERVICE DISCONNECT CLEARLY VISIBLE FROM THE LOCATION WHERE THE LEVER IS OPERATED

3. MARKINGS, VERBIAGE, FORMAT AND TYPE OF MATERIAL

- a. VERBIAGE: CAUTION; SOLAR ELECTRIC SYSTEM CONNECTED
- b. FORMAT:

- (1) WHITE LETTERING ON A RED BACKGROUND
- (2) MINIMUM 3/8 INCH LETTER HEIGHT
- (3) ALL LETTERS SHALL BE CAPITALIZED
- (4) ARIAL OR SIMILAR FONT, NON-BOLD

c. MATERIAL:

- (1) REFLECTIVE, WEATHER RESISTANT MATERIAL SUITABLE FOR THE ENVIRONMENT (USE UL-969) AS STANDARD FOR WEATHER RATING); DURABLE ADHESIVE MATERIALS MEET THIS REQUIREMENT.

C. MARKING REQUIREMENTS ON DC CONDUIT, RACEWAYS, ENCLOSURES, CABLE ASSEMBLIES, DC COMBINERS AND JUNCTION BOXES;

- 1. MARKING: PLACEMENT, VERBIAGE, FORMAT AND TYPE OF MATERIAL.

- a. PLACEMENT: MARKINGS SHALL BE PLACED EVERY 10 (TEN) FEET ON ALL INTERIOR AND EXTERIOR DC CONDUITS, RACEWAYS, ENCLOSURES AND CABLE ASSEMBLIES, AT TURNS ABOVE AND/OR BELOW PENETRATIONS, ALL DC COMBINERS AND JUNCTION BOXES.

b. VERBIAGE: CAUTION SOLAR CIRCUIT

c. THE FORMAT AND TYPE OF MATERIAL SHALL ADHERE TO SECTION B-3.B & C ABOVE

D. INVERTERS ARE NOT REQUIRED TO HAVE CAUTION MARKINGS

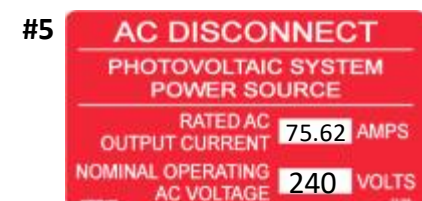
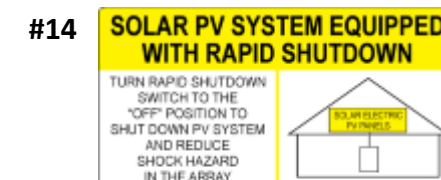
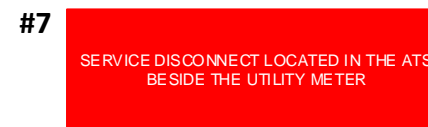
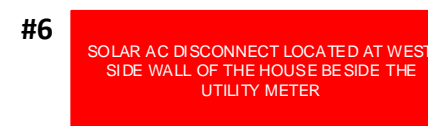

Rails and Splices : PSR-B84 (BLACK)	Roof Attachment : Pegasus Comp Mount
Rafter Spacing : 24 in	There is one layer of shingles Roofing material is asphalt shingles
Attachment Span: 4ft	The roof is located in 115mph wind zone

Utility Meter



Module Dimension		
	Pitch	Azimuth
Roofs		
A	34°	192°
B	34°	192°
C	34°	282°



1600 Heritage Commerce Ct Ste 104, Wake Forest NC 27587
O: 919.948.6474
E: info@8msolar.com

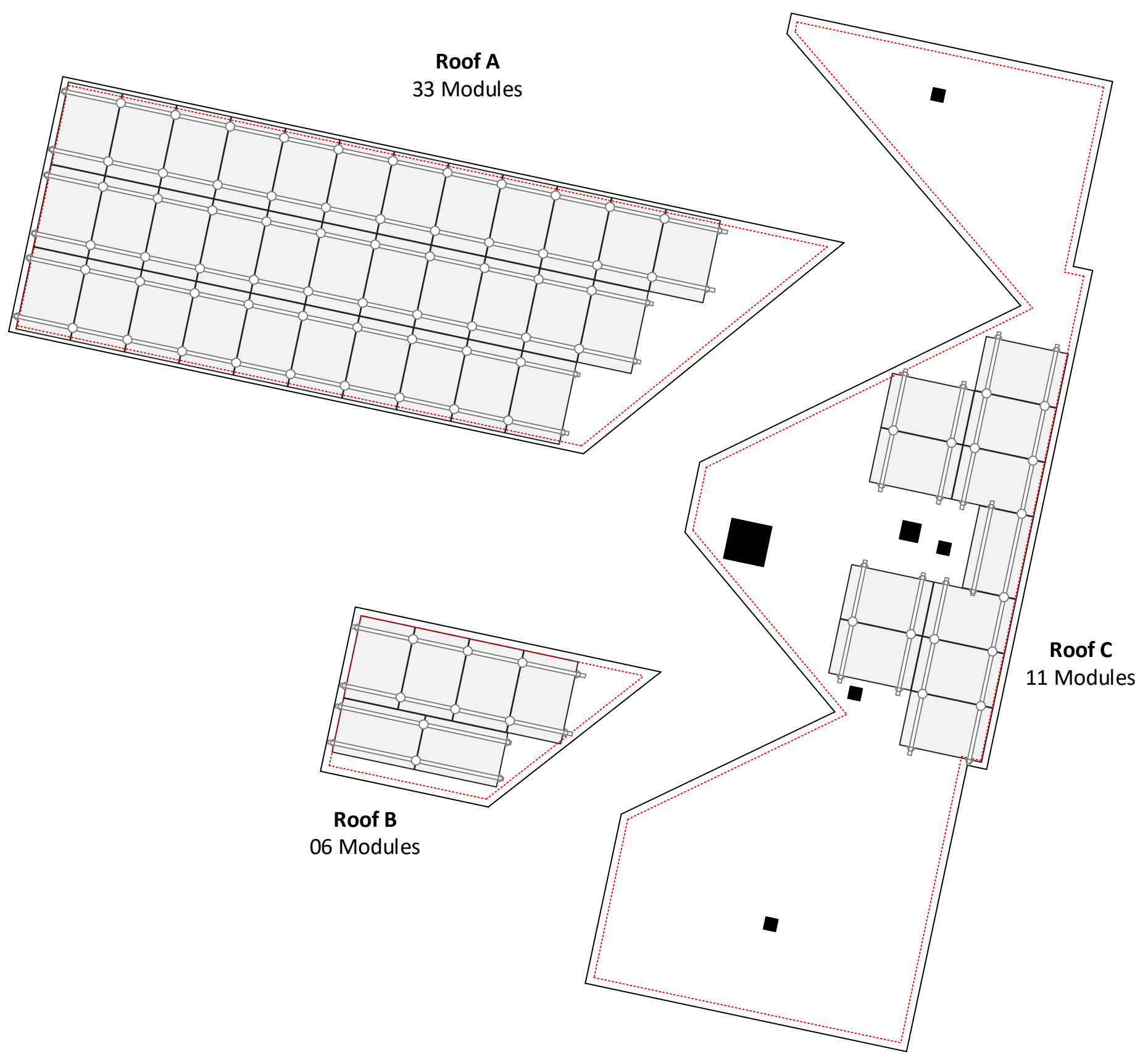

6" clearance from each side of the roof

PV LABELS

Sr No	Code	Qty
01	02-314	10
02	03-302	01
03	02-316	01
04	03-390	01
05	03-306	01
06	8M-001	01
07	8M-002	01
08	05-108	02
09	05-211	03
10	05-372	01
11	05-215	01
12	05-216	01
13	07-359	01
14	07-111	02
15	8M-005	01

- 66 x PSR-B84: Pegasus Rail, Black, 84" (7 Feet)
- 46 x PSR-SPL: Pegasus - Bonded, Structural Splice
- 80 x PSR-MCB: Pegasus - Multiclamp, Mid/End, 30 to 40 mm, Black
- 40 x PSR-HEC: Pegasus - Hidden End Clamp
- 50 x PSR-MLP: Pegasus - MLPE Mount
- 17 x PSR-LUG: Pegasus - Grounding Lug
- 75 x PSR-WMC: Pegasus - Wire Management Clip
- 09 x PSR-CBG: Pegasus - Cable Grip
- 40 x PSR-CAP: Pegasus - End Cap
- 108 x PSCR-UBBDT: Pegasus Comp Mount - Open Slot, Black L Foot, Black Flashing, Dovetail 3/8" T-Bolt
- 100 x Heyco Wire Clips

- SOLAR MODULES**
- 50 x SOLARIA PowerX-390R
- INVERTER & SUPPORTING ITEMS**
- 50 x Enphase IQ8PLUS-72-2-US micro inverter
 - 01 x X-IQ-AM1-240-4 IQ Combiner 4
- ENPHASE CABLES AND ACCESSORIES**
- 53 x Q-12-10-240: Q Cable
 - 03 x Q-12-20-200: Q Cable
 - 01 x Q-12-RAW-300:Q Cable, 12 AWG (50ft)
 - 08 x Q-CONN-10M Male Field-wireable connector
 - 08 x Q-CONN-10F Female Field-wireable connector
 - 04 x Q-TERM-10: Terminator Cap
 - 04 x Q-SEAL-10: Female Sealing Cap
 - 01 x Q-CLIP-100: Q Cable rail mount cable management clip (Pack of 100)
 - 01 x Q-DISC-10: Disconnect tool
 - 04 x Eaton BR220B with hold down kit support (Circuit breaker, 2 pole, 20A)
 - 02 x CT-200-SPLIT

Daniel Brown
1261 Rollins Mill Rd
Holly Springs NC 27540



A 12/28/2022

Customer's Signature

JOB NUMBER
22-598-DB00

PROJECT STATUS
PERMITTING

SHEET
BILL OF MATERIAL

BILL OF MATERIAL
SCALE: 1/8" - 1' 0"

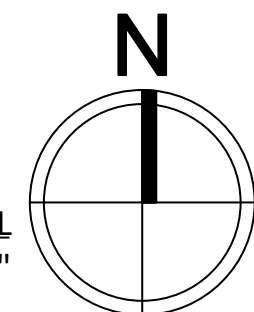

DB
22598DB00-6

PV System Dead Load
(Panel + Racking weight) / PV System Area
 (No. of panels x Weight of panel(lbs.) +Length of racking(ft.) x 1.17 lb.ft) /
 (No. of panels x Height x Width) = Total psf

The roof is located in 115mph wind zone

There is one layer of shingles
 Roofing material is asphalt shingles

Utility
 Meter



Module Dimension	Pitch	Azimuth
A	34°	192°
B	34°	192°
C	34°	282°

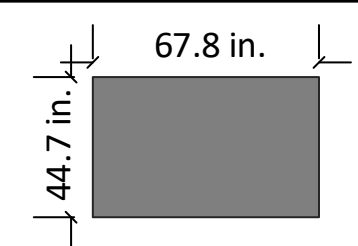

1600 Heritage Commerce Ct Ste
 104, Wake Forest NC 27587
 O: 919.948.6474
 E: info@8msolar.com

Daniel Brown
 1261 Rollins Mill Rd
 Holly Springs NC 27540

ROOF A
<p>PV System Dead Load (Panel + Racking weight) / PV System Area (33 panels x 48.7 lbs./panel + 248 ft. of racking x 1.17 lb.ft) / (33 panels x 5.65' x 3.72') = 2.73 psf</p>

ROOF B
<p>PV System Dead Load (Panel + Racking weight) / PV System Area (06 panels x 48.7 lbs./panel + 53 ft. of racking x 1.17 lb.ft) / (06 panels x 5.65' x 3.72') = 2.80 psf</p>

ROOF C
<p>PV System Dead Load (Panel + Racking weight) / PV System Area (11 panels x 48.7 lbs./panel + 87 ft. of racking x 1.17 lb.ft) / (11 panels x 5.65' x 3.72') = 2.75 psf</p>



PV Installation
 Professional
 Ali Buttar
 PVIP #031310-32

A 12/28/2022

Customer's Signature

JOB NUMBER
 22-598-DB00

PROJECT STATUS
 PERMITTING

SHEET
 PV DEAD LOAD

DB
 22598DB00-7

Solaria PowerX-400R Performance Series

Achieving over 20.5% efficiency, Solaria PowerX Performance solar panels feature Solaria's core cell cutting technology, offering higher-power and attractive black-on-black aesthetics compared to conventional solar panels. Solaria has been the market leader in cut-cell technologies for over a decade. With a comprehensive 25-year warranty, PowerX delivers the latest in power and reliability for homeowners.



High Efficiency, High Power

At 400 watts and 20.5% efficiency, Solaria PowerX solar panels are one of the highest power residential panels available.



High Quality and Reliability

State-of-the-art cell cutting technology and advanced panel construction ensure that PowerX panels are highly reliable and designed to far exceed the industry-leading 25-year warranty.



All Black Aesthetics

Compared to conventional panels, Solaria PowerX panels have a more uniform all-black appearance.



Best System Value

Solaria PowerX solar panels produce more power per square meter area. This reduces installation costs due to fewer balance of system components.



Improved Shading Tolerance

Sub-strings are interconnected in parallel, which dramatically lowers the shading losses and boosts energy yield.



Low Light Performance

PowerX maintains high efficiency at low irradiance further ensuring maximum energy yield.

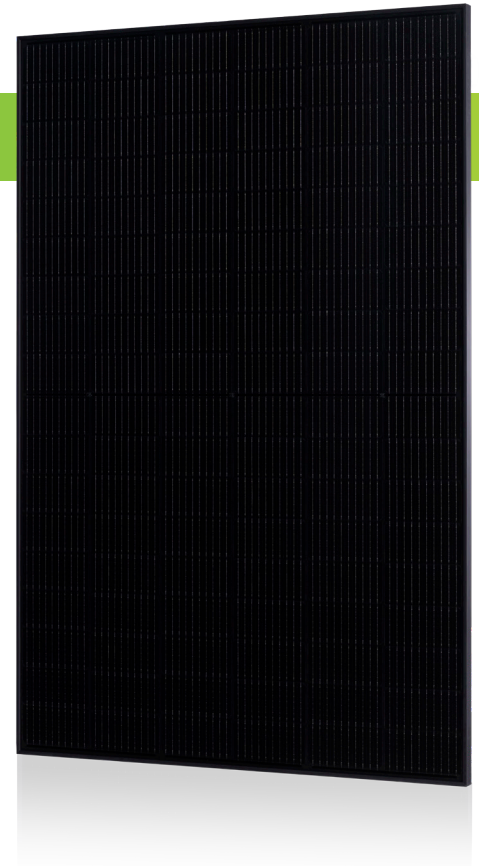

About Solaria

Established in 2000, The Solaria Corporation has created one of the industry's most respected IP portfolios, with over 250 issued and pending patents in PV solar cell and module technology. Headquartered in California, Solaria has developed a technology platform that unlocks the potential of solar energy.

Performance at STC (1000W/m², 25° C, AM 1.5)

Solaria PowerX-		390R	395R	400R
Max Power (P _{max})	[W]	390	395	400
Efficiency	[%]	20.0	20.2	20.5
Open Circuit Voltage (V _{oc})	[V]	36.9	37.1	37.3
Short Circuit Current (I _{sc})	[A]	13.52	13.60	13.68
Max Power Voltage (V _{mp})	[V]	30.6	30.8	31.0
Max Power Current (I _{mp})	[A]	12.73	12.82	12.9
Power Tolerance	[%]	-0/+3	-0/+3	-0/+3

Performance at NOCT (800W/m², 20° C Amb, Wind 1 m/s, AM 1.5)

Max Power (P _{max})	[W]	290	293	297
Open Circuit Voltage (V _{oc})	[V]	34.3	34.5	34.7
Short Circuit Current (I _{sc})	[A]	11.01	11.10	11.13
Max Power Voltage (V _{mp})	[V]	28.50	28.60	28.76
Max Power Current (I _{mp})	[A]	10.20	10.26	10.32

Temperature Characteristics

NOCT	[°C]	45 +/-2
Temp. Coeff. of P _{max}	[% / °C]	-0.36
Temp. Coeff. of V _{oc}	[% / °C]	-0.28
Temp. Coeff. of I _{sc}	[% / °C]	0.048

Design Parameters

Operating temperature	[°C]	-40 to +85
Max System Voltage	[V]	1000
Max Fuse Rating	[A]	25
Bypass Diodes	[#]	3

IV Curves vs. Irradiance (400W Panel)

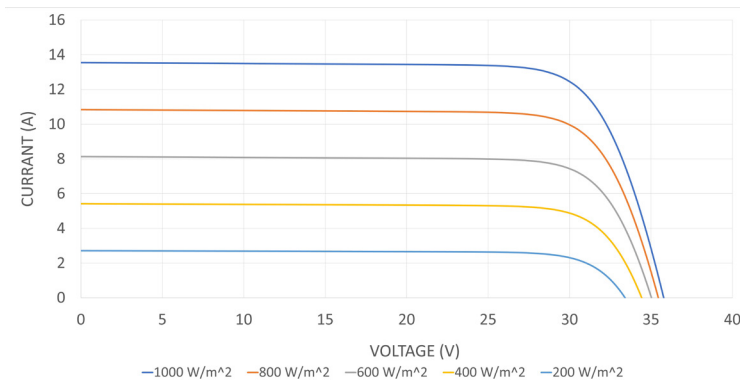

Mechanical Characteristics

Cell Type	Monocrystalline Silicon
Dimensions (L x W x H)	67.8" x 44.7" x 1.4"
	1723mm x 1134mm x 35mm
Weight	22.1 kg / 48.7 lbs
Glass Type / Thickness	AR Coated, Tempered / 3.2mm
Frame Type	Black Anodized Aluminum
Cable Type / Length	12 AWG PV Wire (UL) / 1100mm
Connector Type	MC4
Junction Box	IP68 / 3 diodes
Front Load	5400 Pa / 113 psf*
Rear Load	2400 Pa / 50 psf*

* Refer to Solaria Installation Manual for details

Certifications / Warranty

Certifications	UL 61730 / IEC 61215 / IEC 61730
Fire Type (UL 1703)	2
Power, Parts & Labor Warranty	25 years*

* Warranty details at www.solaria.com

Packaging

Stacking Method	Vertical / Palletized
Panels/ Pallet	31
Pallet Dims (L x W x H)	69.3" x 44.3" x 49.3"
	1760mm x 1125mm x 1253mm
Pallet Weight	745 kg / 1642 lbs
Pallets / 40-ft Container	26
Panels / 40-ft Container	806

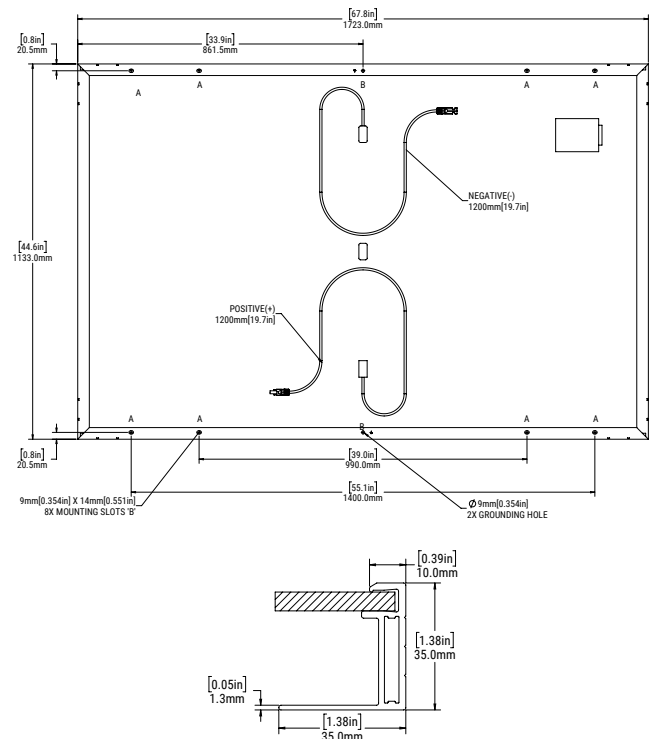

Comprehensive 25-Year Warranty

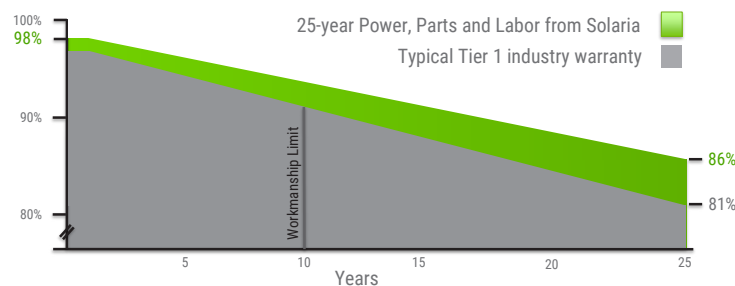



IQ8 Series Microinverters

Our newest IQ8 Microinverters are the industry’s first microgrid-forming, software-defined microinverters with split-phase power conversion capability to convert DC power to AC power efficiently. The brain of the semiconductor-based microinverter is our proprietary application-specific integrated circuit (ASIC) which enables the microinverter to operate in grid-tied or off-grid modes. This chip is built in advanced 55nm technology with high speed digital logic and has super-fast response times to changing loads and grid events, alleviating constraints on battery sizing for home energy systems.



Part of the Enphase Energy System, IQ8 Series Microinverters integrate with the Enphase IQ Battery, Enphase IQ Gateway, and the Enphase App monitoring and analysis software.



IQ8 Series Microinverters redefine reliability standards with more than one million cumulative hours of power-on testing, enabling an industry-leading limited warranty of up to 25 years.



Connect PV modules quickly and easily to IQ8 Series Microinverters using the included Q-DCC-2 adapter cable with plug-n-play MC4 connectors.



IQ8 Series Microinverters are UL Listed as PV Rapid Shut Down Equipment and conform with various regulations, when installed according to manufacturer’s instructions.

Easy to install

- Lightweight and compact with plug-n-play connectors
- Power Line Communication (PLC) between components
- Faster installation with simple two-wire cabling

High productivity and reliability

- Produce power even when the grid is down*
- More than one million cumulative hours of testing
- Class II double-insulated enclosure
- Optimized for the latest high-powered PV modules

Microgrid-forming

- Complies with the latest advanced grid support**
- Remote automatic updates for the latest grid requirements
- Configurable to support a wide range of grid profiles
- Meets CA Rule 21 (UL 1741-SA) requirements

* Only when installed with IQ System Controller 2, meets UL 1741. IQ8H-208V operates only in grid-tied mode.

** IQ8 Series Microinverters supports split phase, 240V. IQ8H-208 supports split phase, 208V only.

IQ8 Series Microinverters

INPUT DATA (DC)		IQ8-60-2-US	IQ8PLUS-72-2-US	IQ8M-72-2-US	IQ8A-72-2-US	IQ8H-240-72-2-US	IQ8H-208-72-2-US ¹	
Commonly used module pairings ²	W	235 – 350	235 – 440	260 – 460	295 – 500	320 – 540+	295 – 500+	
Module compatibility		60-cell/120 half-cell	60-cell/120 half-cell, 66-cell/132 half-cell and 72-cell/144 half-cell					
MPPT voltage range	V	27 – 37	29 – 45	33 – 45	36 – 45	38 – 45	38 – 45	
Operating range	V	25 – 48	25 – 58					
Min/max start voltage	V	30 / 48	30 / 58					
Max input DC voltage	V	50	60					
Max DC current ³ [module Isc]	A	15						
Overvoltage class DC port		II						
DC port backfeed current	mA	0						
PV array configuration		1x1 Ungrounded array; No additional DC side protection required; AC side protection requires max 20A per branch circuit						
OUTPUT DATA (AC)		IQ8-60-2-US	IQ8PLUS-72-2-US	IQ8M-72-2-US	IQ8A-72-2-US	IQ8H-240-72-2-US	IQ8H-208-72-2-US ¹	
Peak output power	VA	245	300	330	366	384	366	
Max continuous output power	VA	240	290	325	349	380	360	
Nominal (L-L) voltage/range ⁴	V	240 / 211 – 264					208 / 183 – 250	
Max continuous output current	A	1.0	1.21	1.35	1.45	1.58	1.73	
Nominal frequency	Hz	60						
Extended frequency range	Hz	50 – 68						
AC short circuit fault current over 3 cycles	Arms	2					4.4	
Max units per 20 A (L-L) branch circuit ⁵		16	13	11	11	10	9	
Total harmonic distortion		<5%						
Overvoltage class AC port		III						
AC port backfeed current	mA	30						
Power factor setting		1.0						
Grid-tied power factor (adjustable)		0.85 leading – 0.85 lagging						
Peak efficiency	%	97.5	97.6	97.6	97.6	97.6	97.4	
CEC weighted efficiency	%	97	97	97	97.5	97	97	
Night-time power consumption	mW	60						
MECHANICAL DATA								
Ambient temperature range		-40°C to +60°C (-40°F to +140°F)						
Relative humidity range		4% to 100% (condensing)						
DC Connector type		MC4						
Dimensions (HxWxD)		212 mm (8.3") x 175 mm (6.9") x 30.2 mm (1.2")						
Weight		1.08 kg (2.38 lbs)						
Cooling		Natural convection – no fans						
Approved for wet locations		Yes						
Pollution degree		PD3						
Enclosure		Class II double-insulated, corrosion resistant polymeric enclosure						
Environ. category / UV exposure rating		NEMA Type 6 / outdoor						
COMPLIANCE								
Certifications		CA Rule 21 (UL 1741-SA), UL 62109-1, UL1741/IEEE1547, FCC Part 15 Class B, ICES-0003 Class B, CAN/CSA-C22.2 NO. 107.1-01 This product is UL Listed as PV Rapid Shut Down Equipment and conforms with NEC 2014, NEC 2017, and NEC 2020 section 690.12 and C22.1-2018 Rule 64-218 Rapid Shutdown of PV Systems, for AC and DC conductors, when installed according to manufacturer's instructions.						

(1) The IQ8H-208 variant will be operating in grid-tied mode only at 208V AC. (2) No enforced DC/AC ratio. See the compatibility calculator at <https://link.enphase.com/module-compatibility> (3) Maximum continuous input DC current is 10.6A (4) Nominal voltage range can be extended beyond nominal if required by the utility. (5) Limits may vary. Refer to local requirements to define the number of microinverters per branch in your area.

Enphase IQ Combiner 4/4C

X-IQ-AM1-240-4
X-IQ-AM1-240-4C



The **Enphase IQ Combiner 4/4C** with Enphase IQ Gateway and integrated LTE-M1 cell modem (included only with IQ Combiner 4C) consolidates interconnection equipment into a single enclosure and streamlines IQ microinverters and storage installations by providing a consistent, pre-wired solution for residential applications. It offers up to four 2-pole input circuits and Eaton BR series busbar assembly.

Smart

- Includes IQ Gateway for communication and control
- Includes Enphase Mobile Connect cellular modem (CELLMODEM-M1-06-SP-05), included only with IQ Combiner 4C
- Includes solar shield to match Enphase IQ Battery aesthetics and deflect heat
- Flexible networking supports Wi-Fi, Ethernet, or cellular
- Optional AC receptacle available for PLC bridge
- Provides production metering and consumption monitoring

Simple

- Centered mounting brackets support single stud mounting
- Supports bottom, back and side conduit entry
- Up to four 2-pole branch circuits for 240 VAC plug-in breakers (not included)
- 80A total PV or storage branch circuits

Reliable

- Durable NRTL-certified NEMA type 3R enclosure
- Five-year limited warranty
- Two years labor reimbursement program coverage included for both the IQ Combiner SKU's
- UL listed



To learn more about Enphase offerings, visit enphase.com

Enphase IQ Combiner 4/4C

MODEL NUMBER

IQ Combiner 4 (X-IQ-AM1-240-4)	IQ Combiner 4 with Enphase IQ Gateway printed circuit board for integrated revenue grade PV production metering (ANSI C12.20 +/- 0.5%) and consumption monitoring (+/- 2.5%). Includes a silver solar shield to match the IQ Battery system and IQ System Controller 2 and to deflect heat.
IQ Combiner 4C (X-IQ-AM1-240-4C)	IQ Combiner 4C with Enphase IQ Gateway printed circuit board for integrated revenue grade PV production metering (ANSI C12.20 +/- 0.5%) and consumption monitoring (+/- 2.5%). Includes Enphase Mobile Connect cellular modem (CELLMODEM-M1-06-SP-05), a plug-and-play industrial-grade cell modem for systems up to 60 microinverters. (Available in the US, Canada, Mexico, Puerto Rico, and the US Virgin Islands, where there is adequate cellular service in the installation area.) Includes a silver solar shield to match the IQ Battery and IQ System Controller and to deflect heat.

ACCESSORIES AND REPLACEMENT PARTS (not included, order separately)

Ensemble Communications Kit COMMS-CELLMODEM-M1-06 CELLMODEM-M1-06-SP-05 CELLMODEM-M1-06-AT-05	- Includes COMMS-KIT-01 and CELLMODEM-M1-06-SP-05 with 5-year Sprint data plan for Ensemble sites - 4G based LTE-M1 cellular modem with 5-year Sprint data plan - 4G based LTE-M1 cellular modem with 5-year AT&T data plan
Circuit Breakers BRK-10A-2-240V BRK-15A-2-240V BRK-20A-2P-240V BRK-15A-2P-240V-B BRK-20A-2P-240V-B	Supports Eaton BR210, BR215, BR220, BR230, BR240, BR250, and BR260 circuit breakers. Circuit breaker, 2 pole, 10A, Eaton BR210 Circuit breaker, 2 pole, 15A, Eaton BR215 Circuit breaker, 2 pole, 20A, Eaton BR220 Circuit breaker, 2 pole, 15A, Eaton BR215B with hold down kit support Circuit breaker, 2 pole, 20A, Eaton BR220B with hold down kit support
EPLC-01	Power line carrier (communication bridge pair), quantity - one pair
XA-SOLARSHIELD-ES	Replacement solar shield for IQ Combiner 4/4C
XA-PLUG-120-3	Accessory receptacle for Power Line Carrier in IQ Combiner 4/4C (required for EPLC-01)
XA-ENV-PCBA-3	Replacement IQ Gateway printed circuit board (PCB) for Combiner 4/4C
X-IQ-NA-HD-125A	Hold down kit for Eaton circuit breaker with screws.

ELECTRICAL SPECIFICATIONS

Rating	Continuous duty
System voltage	120/240 VAC, 60 Hz
Eaton BR series busbar rating	125 A
Max. continuous current rating	65 A
Max. continuous current rating (input from PV/storage)	64 A
Max. fuse/circuit rating (output)	90 A
Branch circuits (solar and/or storage)	Up to four 2-pole Eaton BR series Distributed Generation (DG) breakers only (not included)
Max. total branch circuit breaker rating (input)	80A of distributed generation / 95A with IQ Gateway breaker included
Envoy breaker	10A or 15A rating GE/Siemens/Eaton included
Production metering CT	200 A solid core pre-installed and wired to IQ Gateway
Consumption monitoring CT (CT-200-SPLIT)	A pair of 200 A split core current transformers

MECHANICAL DATA

Dimensions (WxHxD)	37.5 x 49.5 x 16.8 cm (14.75" x 19.5" x 6.63"). Height is 21.06" (53.5 cm) with mounting brackets.
Weight	7.5 kg (16.5 lbs)
Ambient temperature range	-40° C to +46° C (-40° to 115° F)
Cooling	Natural convection, plus heat shield
Enclosure environmental rating	Outdoor, NRTL-certified, NEMA type 3R, polycarbonate construction
Wire sizes	<ul style="list-style-type: none">• 20 A to 50 A breaker inputs: 14 to 4 AWG copper conductors• 60 A breaker branch input: 4 to 1/0 AWG copper conductors• Main lug combined output: 10 to 2/0 AWG copper conductors• Neutral and ground: 14 to 1/0 copper conductors Always follow local code requirements for conductor sizing.
Altitude	To 2000 meters (6,560 feet)

INTERNET CONNECTION OPTIONS

Integrated Wi-Fi	802.11b/g/n
Cellular	CELLMODEM-M1-06-SP-05, CELLMODEM-M1-06-AT-05 (4G based LTE-M1 cellular modem). Note that an Enphase Mobile Connect cellular modem is required for all Ensemble installations.
Ethernet	Optional, 802.3, Cat5E (or Cat 6) UTP Ethernet cable (not included)

COMPLIANCE

Compliance, IQ Combiner	UL 1741, CAN/CSA C22.2 No. 107.1, 47 CFR, Part 15, Class B, ICES 003 Production metering: ANSI C12.20 accuracy class 0.5 (PV production) Consumption metering: accuracy class 2.5
Compliance, IQ Gateway	UL 60601-1/CANCSA 22.2 No. 61010-1

To learn more about Enphase offerings, visit enphase.com



© 2022 Enphase Energy. All rights reserved. Enphase, the Enphase logo, IQ Combiner 4/4C, and other names are trademarks of Enphase Energy, Inc. Data subject to change. 02-14-2022

Rapid shutdown is built-in

The 2014 edition of the National Electrical Code (NEC 2014) added new rapid shutdown requirements for PV systems installed on buildings. Enphase Microinverters fully meet rapid shutdown requirements in the new code without the need to install any additional electrical equipment.

What's new in NEC 2014?

NEC 2014, Section 690.12 applies to PV conductors over 10 feet from the PV array and requires that the conductors power down to 30 volts and 240 volt-amperes within 10 seconds of rapid shutdown initiation.

String inverters require work arounds for rapid shutdown

Work around.

Specialized Rapid Shutdown electrical box installed on the roof within 10 feet of array.

Work around.

Shutoff switch that is easily accessible to first responders on the ground.

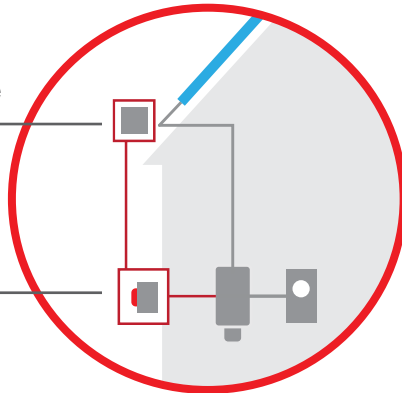

Residential String Inverter

Work around.

Extra conduit in installation.

Work around.

String inverter installed on roof, a hostile environment that string inverters are not built to live in.

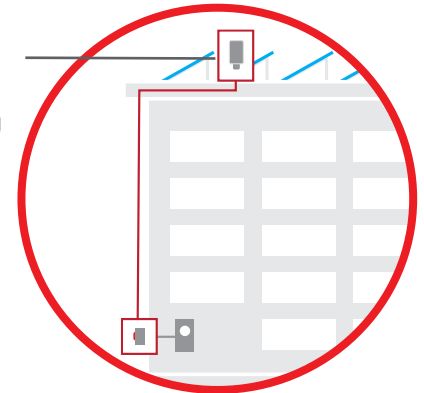

Commercial String Inverter

Enphase comes standard with rapid shutdown capability

All Enphase microinverters, even those that were previously installed, inherently meet rapid shutdown requirements, no additional equipment or workarounds needed

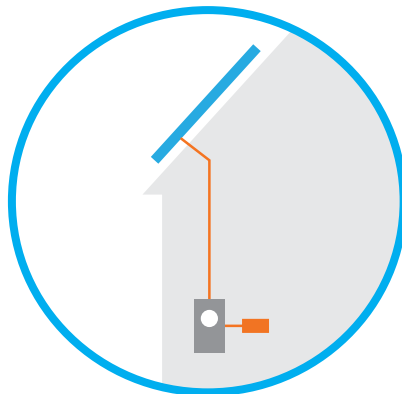

Residential Microinverter

Enphase microinverters can safely shut down automatically, leaving only low-voltage DC electricity isolated to the PV module

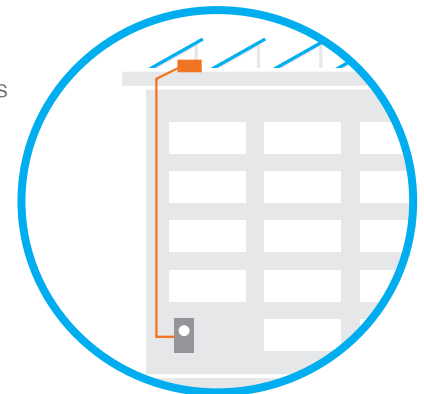

Commercial Microinverter

One Clamp Anywhere

The Multi-Clamp works as mid- or end-clamp, and fits standard 30-40mm frames.

Instant Bonding

The N-S Bonding Jumper bonds row to row with no tools.

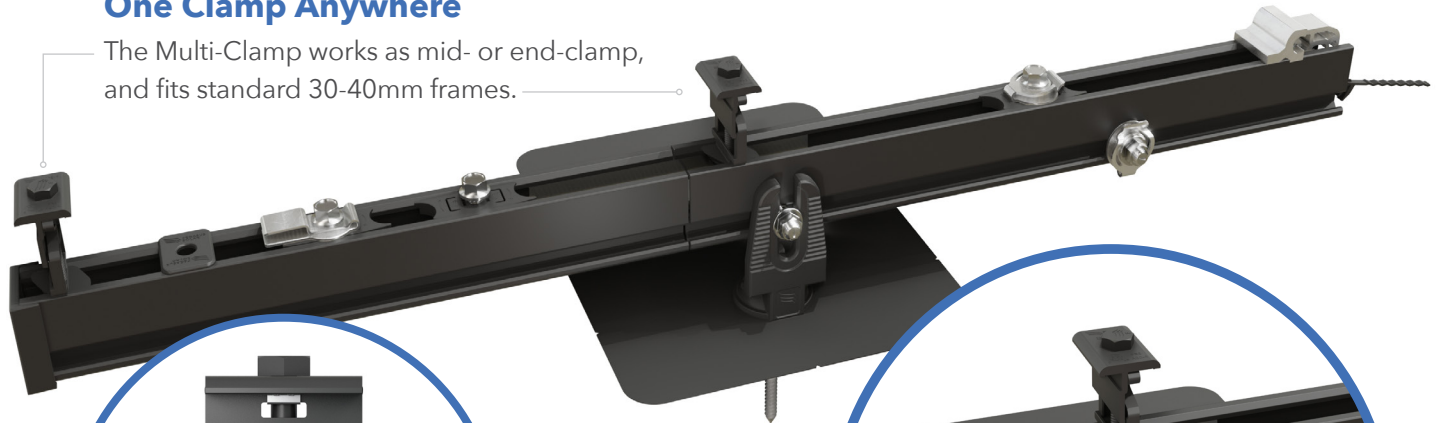

Lifetime Wire Management

Open rail channel holds and protects wires. Clamps won't pinch wires after tightening.

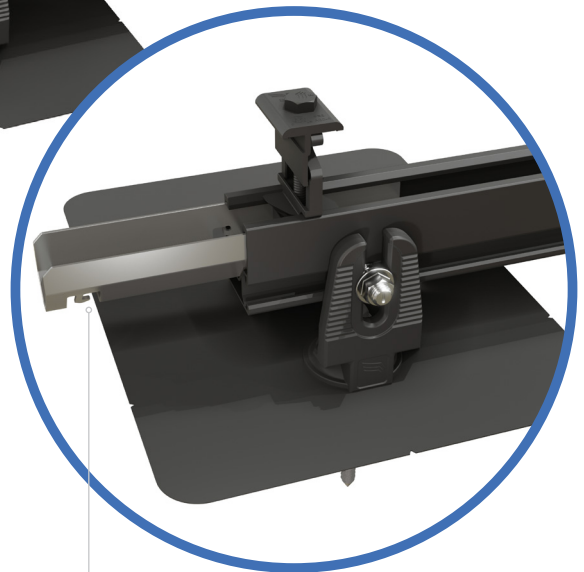

Bonding Structural Splice

Connect rails instantly, without tools, interference or limitations.

Next-Level Solar Mounting

A complete system for hassle-free rooftop installation, from watertight mounts to lifetime wire management.



Simplicity

1/2" socket for everything.
One clamp for mid or end.
No tool splicing and bonding.
Easy wire management.



Code Compliant

UL 2703 listed
LTR-AE-001-2012 listed
Class A fire rating for any slope
ASCE 7-16 PE Certified



Premium Aesthetics

The narrowest panel gap available. Optional Hidden End Clamps and End Caps provide a flush look on the edge of the array.



Watertight for Life

Secured on industry-leading Pegasus Mounts, for composite shingle and tile roofs. Backed by a 25-year warranty.



Pegasus Rail

Available in 14' and 7' lengths for easy layout and shipping.
Open-channel design holds MC4 connectors, PV wire and trunk cables.
Black and Mill finish



Pegasus Max Rail

Maximum-strength design.
Meets specifications for high snow-load and hurricane zones.
Black and Mill finish

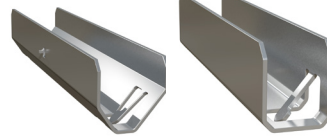

Splice and Max Splice

Installs by hand.
Works over mounts.
Structurally connects and bonds rails automatically; UL2703 listed as reusable.

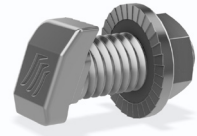

Dovetail T-bolt

Dovetail shape for extra strength.
Uses 1/2" socket.



Multi-Clamp

Fits 30-40mm PV frames, as mid- or end-clamp.
Twist-locks into position; doesn't pinch wires in rail.
Bonds modules to rail; UL2703 listed as reusable



Hidden End Clamp

Offers premium edge appearance.
Preinstalled pull-tab grips rail edge, allowing easy, one-hand installation.
Tucks away for reuse.



Ground Lug

Holds 6 or 8 AWG wire.
Mounts on top or side of rail.
Assembled on MLPE Mount.
UL2703 listed as reusable.



N-S Bonding Jumper

Installs by hand, eliminates row-to-row copper wire.
UL2703 listed as reusable only with Pegasus Rail.



MLPE Mount

Secures and bonds most micro-inverters and optimizers to rail.
Connectors and wires easily route underneath after installation.
UL2703 listed as reusable.

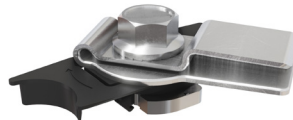

Cable Grip

Secures four PV wires or two trunk cables.
Stainless-steel backing provides durable grip.
Eliminates sagging wires.



Wire Clip

Hand operable.
Holds wires in channel.
Won't slip.



End Cap and Max End Cap

Fits flush to PV module and hides raw or angled cuts.
Hidden drain quickly clears water from rail.

Certifications:

- UL 2703, Edition 1
- LTR-AE-001-2012
- ASCE 7-16 PE certified
- Class A fire rating for any slope roof



Quickly calculate the most efficient layout, spans and materials needed to suit your job. Visit the Pegasus Customer Portal. pegasussolar.com/portal

LOAD		SPAN			
SNOW (PSF)	WIND (MPH)	32"	4'	6'	8'
0	120	PEGASUS RAIL			
	160	PEGASUS RAIL			PEGASUS MAX RAIL
	190	PEGASUS RAIL		PEGASUS MAX RAIL	
15	140	PEGASUS RAIL			PEGASUS MAX RAIL
	160	PEGASUS RAIL		PEGASUS MAX RAIL	
30	160	PEGASUS RAIL		PEGASUS MAX RAIL	
	190	PEGASUS RAIL		PEGASUS MAX RAIL	
45	190	PEGASUS RAIL		PEGASUS MAX RAIL	
70	190	PEGASUS RAIL		PEGASUS MAX RAIL	
110	190	PEGASUS RAIL		PEGASUS MAX RAIL	

For reference only. Spans above are calculated using ASCE 7-16 for a Gable Roof, Exposure Category B, 7-20deg roof angle, 30ft mean roof height with non-exposed modules. For PE certified span tables, visit www.pegasussolar.com/spans.

Patents pending. All rights reserved. ©2021 Pegasus Solar Inc.

COMP MOUNT

One-Piece Flashing with Elevated Cone

No press-fits or deck-level EPDM washers to fail



Encapsulating Design

Raises the water seal 0.9" Above roof deck



Simple 3-Piece Design Watertight For Life

Pegasus solar's comp mounts are a cost effective, high-quality option for rail installations on composition shingle roofs. Designed to last decades, the one-piece flashing with elevated cone means there is simply nothing to fail.



25-Year Warranty

Manufactured with advanced materials and coatings to outlast the roof itself



Code Compliant

Fully IBC/CBC Code Compliant
Exceeds ASCE 7-16 Standards



Superior Waterproofing

Tested to AC286 without sealant
Water seal elevated 0.9" above



All-In-One Kit Packaging

Flashings, L-Feet and SS lags with bonded EPDM washers are included in each 24-pack

1

Drill pilot hole in the center of the rafter.

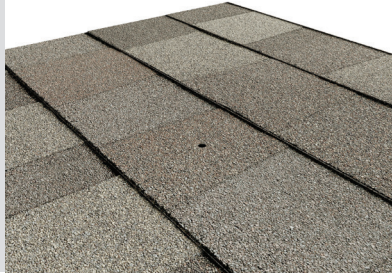
2

Optional: Apply a "u-shape" of sealant to the underside of the flashing and position under 2nd shingle course, cone over pilot hole.

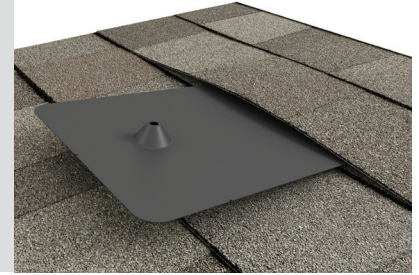
3

Place L-Foot over cone and install lag with washer through L-Foot.

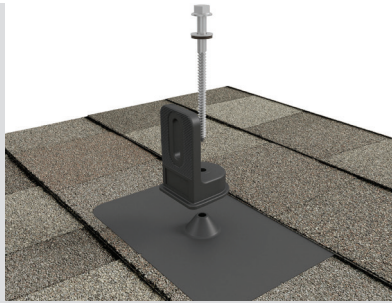
4

Drive lag to required depth. Attach rail per rail manufacturer's instructions.

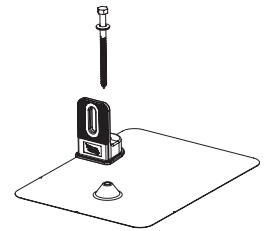
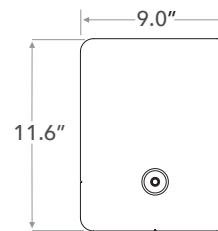
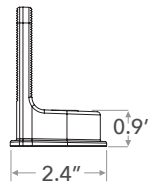
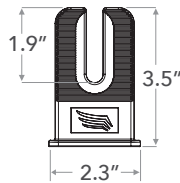
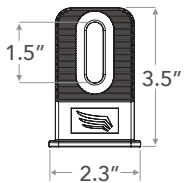
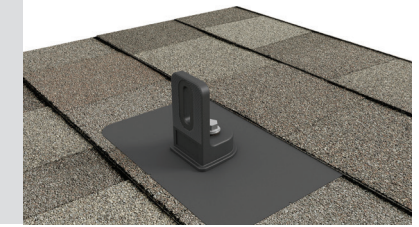

SPECIFICATIONS	COMP MOUNT INSTALL KITS				
SKU	PSCR-CBB0	PSCR-UBB0	SPCR-CBBH	PSCR-CMM0	PSCR-UMM0
Finish	Black L-Foot And Black Flashing			Mill	
L-Foot Type	Closed Slot	Open Slot	Closed Slot	Closed Slot	Open Slot
Kit Contents	L-Foot, Flashing, 5/16" x 4 1/2" SS Lag with metalized EPDM washer	L-Foot, Flashing, 5/16" x 4 1/2" SS Lag with metalized EPDM washer and M10 Hex Bolt	L-Foot, Flashing, 5/16" x 4 1/2" SS Lag with metalized EPDM washer	L-Foot, Flashing, 5/16" x 4 1/2" SS Lag with metalized EPDM washer	L-Foot, Flashing, 5/16" x 4 1/2" SS Lag with metalized EPDM washer
Roof Type	Composition Shingle				
Certifications	IBC, ASCE/SEI 7-16, AC286				
Install Application	Railed Systems				
Compatible Rail	Most				
Kit Quantity	24				
Boxes per Pallet	72				

Protected under US Patent: 10,998,847. Additional patents pending. All rights reserved. ©2021 Pegasus

SolaDeck

PV ROOF-MOUNT ENCLOSURE

**INTRODUCED AT
*SOLAR POWER 2007***



**UL50 Type 3R Enclosure • Stamped 18 gauge gal. steel • Powder coated finish
• Weather tight**



Enclosure Includes:

- Dual ground lug
- Universal DIN rail
- 1/2", 3/4" & 1" knockouts
- Wire strain relief clip
- Complete hardware package

PV Roof-Mount Combiner/Enclosure

Benefits

- The ability to prep the building is now possible
- Replaces several parts used today
- Provides professional looking install
- Saves time on install
- Allows for easy access
- Guaranteed seal to roof
- Low profile design

***For product information contact us at
(866) 367-7782***

www.commdeck.com



RSTC Enterprises, Inc
2219 Heimstead Road
Eau Claire, WI 54703
1 (866) 367 - 7782



SolaDeck Part # 780

Specifications:

**18 Gauge Steel Base (1) and Cover (2)
Pre Punched 7 holes in base (1) for roof deck
Pre Punched 4 holes in base (1) and cover (2) for match
Draw Process both parts
Powder Coated to withstand 1000 hours Salt Spray (Primer Gray)
High UV resistance
15" x 15" flashing dimension
Cavity dimension 8"W x 9" L x 2.5"D
Approx. 162 Cubic inch equipment cavity
Norloked steel base plate (3) to drawn base (2)
Three knockout locations .5", .75" and 1"
3" DIN rail installed
Grounding Lug- Installed (In Equipment Cavity)
Wire Strain Relief Clip –Installed (In Equipment Cavity)
Hardware pack withstands 500 hours Salt Spray
 7 - 2" Trusshead Screws
 4 - .5" 8-32 thread cutting screws
 4 - #10 Bonded Seal washers
 1 – Foam closed Cell Seal
ETL Listed UL50 Type 3R**

Total Weight 6.9 pounds each

Packaging:

**Individually bagged and boxed
Box dimension 15.5"w x 16" L x 3" D
White Carton labeled with Cut out template
Print One Color - Black**

**Master Cartons of 6 Units each
Master Carton dimension 18.75"x16"x16.375"
Master Carton Weight – 42 pounds
18 Master Cartons per skid Approx 800 pounds with skid**

Product data sheet

Specifications

SQUARE D

Green Premium™



Safety switch, general duty, fusible, 100A, 3 wire, 2 poles, 1 neutral, 30hp, 240VAC, Type 3R, bolt on hub provision

D223NRB

Product availability : Stock - Normally stocked in distribution facility

Price* : 480.00 USD

Main

Product	Single Throw Safety Switch
Duty Rating	General duty
Device Application	Residential
Disconnect Type	Fusible disconnect switch
Factory Installed Neutral	Neutral (factory installed)
Phase	3 phase
Number of Poles	2
Current Rating	100 A
Voltage Rating	240 V AC
Enclosure Rating NEMA	NEMA 3R
Maximum Horse Power Rating	7.5 hp 240 V at AC 60 Hz for 1 phase conforming to NEC 240.6 15 hp 240 V at AC 60 Hz for 3 phase conforming to NEC 240.6 15 hp 240 V at AC 60 Hz for 1 phase conforming to NEC 430.52 30 hp 240 V at AC 60 Hz for 3 phase conforming to NEC 430.52

Complementary

Short Circuit Current Rating	100 kA maximum depending on fuse H, K or R
Fuse type	H, K or R
Mounting Type	Surface
Electrical Connection	Lugs
Wiring configuration	3-wire
Wire Size	AWG 14...AWG 1 copper AWG 12...AWG 1 aluminium
Tightening torque	35 lbf.in (3.95 N.m) 0.00...0.01 in ² (2.08...5.26 mm ²) (AWG 14...AWG 10) 40 lbf.in (4.52 N.m) 0.01 in ² (8.37 mm ²) (AWG 8) 35 lbf.in (3.95 N.m) (AWG 14...AWG 10) 45 lbf.in (5.08 N.m) 0.02...0.03 in ² (12.3...21.12 mm ²) (AWG 6...AWG 4) 50 lbf.in (5.65 N.m) (AWG 3...AWG 1)
Depth	6.5 in (165.10 mm)
Width	10.56 in (268.22 mm)
Height	17.5 in (444.50 mm)

* Price is "List Price" and may be subject to a trade discount – check with your local distributor or retailer for actual price.

Net Weight	15.43 lb(US) (7 kg)
------------	---------------------

Environment

Certifications	UL listed file E2875
----------------	----------------------

Ordering and shipping details

Category	00106-D & DU SW,NEMA3R, 30-200A
Discount Schedule	DE1A
GTIN	785901460701
Nbr. of units in pkg.	1
Package weight(Lbs)	15.60 lb(US) (7.076 kg)
Returnability	Yes
Country of origin	US

Packing Units

Unit Type of Package 1	PCE
Package 1 Height	7.30 in (18.542 cm)
Package 1 width	10.80 in (27.432 cm)
Package 1 Length	20.00 in (50.8 cm)
Unit Type of Package 2	PAL
Number of Units in Package 2	40
Package 2 Weight	650.00 lb(US) (294.835 kg)
Package 2 Height	41.00 in (104.14 cm)
Package 2 width	41.00 in (104.14 cm)
Package 2 Length	48.00 in (121.92 cm)

Offer Sustainability

Sustainable offer status	Green Premium product
California proposition 65	WARNING: This product can expose you to chemicals including: Lead and lead compounds, which is known to the State of California to cause cancer and birth defects or other reproductive harm. For more information go to www.P65Warnings.ca.gov
REACH Regulation	REACH Declaration
REACH free of SVHC	Yes
EU RoHS Directive	Compliant EU RoHS Declaration
Mercury free	Yes
RoHS exemption information	Yes
China RoHS Regulation	China RoHS declaration Product out of China RoHS scope. Substance declaration for your information.
Environmental Disclosure	Product Environmental Profile
PVC free	Yes

Contractual warranty

Warranty	18 months
----------	-----------

Dimensions

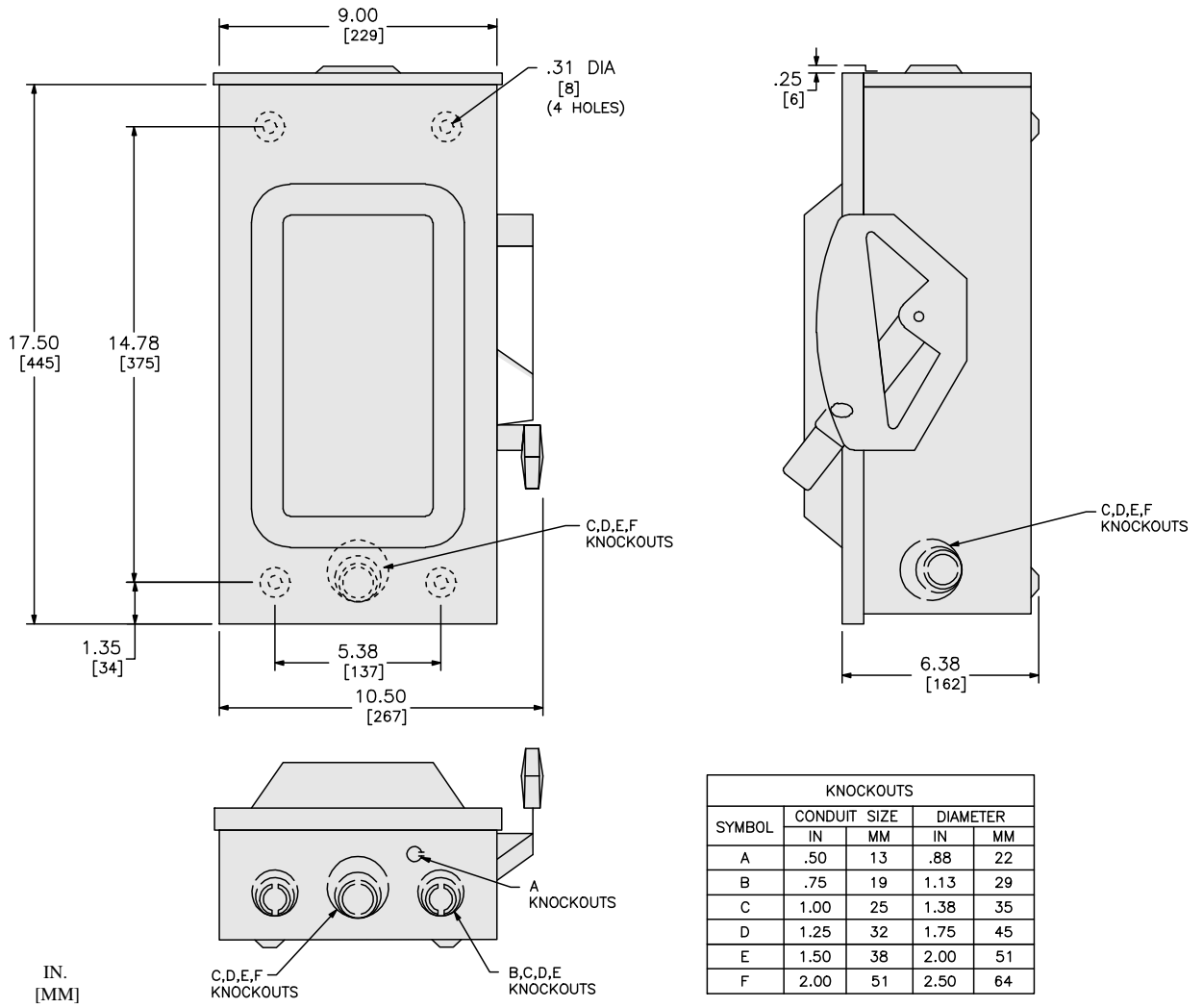

WHEN MOUNTING, ALLOW 4.00/[102] MIN. CLEARANCE BETWEEN ENCLOSURES FOR OPENING OF SIDE HINGED DOOR.

TOP OF NEM A TYPE 3R DEVICES HAVE PROVISIONS FOR MAX 2.50/[64] Bolt-ON HUB.

DU323RB REQUIRES FIELD INSTALLATION OF EQUIPMENT GROUNDING KIT GTK0610 WHEN USED AS SERVICE EQUIPMENT.

ALL DIMENSIONS ARE APPROXIMATE. REFER TO TECHNICAL DRAWINGS AND DOCUMENTATION FOR COMPLETE DETAILS.

TI_DIM_GD1003R

Wiring Diagram

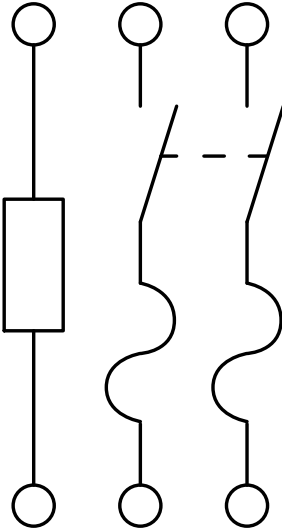

223NRB
CD223NRB