



Scott E. Wyssling, PE
Jon P. Ward, SE, PE
Gregory T. Elvestad, PE

76 North Meadowbrook Drive
Alpine, UT 84004
office (201) 874-3483
swyssling@wysslingconsulting.com

June 10, 2022

Legacy Solar
3333 Digital Drive #600
Lehi, UT 84043

Re: Engineering Services
Loker Residence
200 Castlebay Drive, Sanford NC
11.000 kW System

To Whom It May Concern:

We have received information regarding solar panel installation on the roof of the above referenced structure. Our evaluation of the structure is to verify the existing capacity of the roof system and its ability to support the additional loads imposed by the proposed solar system.

A. Site Assessment Information

1. Site visit documentation identifying attic information including size and spacing of framing for the existing roof structure.
2. Design drawings of the proposed system including a site plan, roof plan and connection details for the solar panels. This information will be utilized for approval and construction of the proposed system.

B. Description of Structure:

Roof Framing: 2x8 dimensional lumber at 16" on center.
Roof Material: Composite Asphalt Shingles
Roof Slope: 38 degrees
Attic Access: Accessible
Foundation: Permanent

C. Loading Criteria Used

- **Dead Load**
 - Existing Roofing and framing = 7 psf
 - New Solar Panels and Racking = 3 psf
 - TOTAL = 10 PSF
- **Live Load** = 20 psf (reducible) – 0 psf at locations of solar panels
- **Ground Snow Load** = 15 psf
- **Wind Load** based on ASCE 7-10
 - Ultimate Wind Speed = 115 mph (based on Risk Category II)
 - Exposure Category C

Analysis performed of the existing roof structure utilizing the above loading criteria is in accordance with the North Carolina Residential Code (2015 IRC), including provisions allowing existing structures to not require strengthening if the new loads do not exceed existing design loads by 105% for gravity elements and 110% for seismic elements. This analysis indicates that the existing framing will support the additional panel loading without damage, if installed correctly.

D. Solar Panel Anchorage

1. The solar panels shall be mounted in accordance with the most recent Unirac installation manual. If during solar panel installation, the roof framing members appear unstable or deflect non-uniformly, our office should be notified before proceeding with the installation.
2. Connection on the roof is utilizing (4) ½" or #14 screws into the existing decking to resist uplift forces. Contractor to verify installation to be performed in accordance with the Unirac recommendations. Pull out values per screw are based on National Design Specification values for CDX plywood and are identified as 208 lbs/inch. Based on ½" sheathing the value per screw would be 104 lbs providing 416 lbs uplift resistance per attachment.
3. Considering the wind speed, roof slopes, size and spacing of framing members, and condition of the roof, the panel supports shall be placed no greater than 60" on center.
4. Panel supports connections shall be staggered to distribute load to adjacent framing members.

Based on the above evaluation, this office certifies that with the racking and mounting specified, the existing roof system will adequately support the additional loading imposed by the solar system. This evaluation is in conformance with the North Carolina Residential Code, current industry standards, and is based on information supplied to us at the time of this report.

Should you have any questions regarding the above or if you require further information do not hesitate to contact me.

Very truly yours,

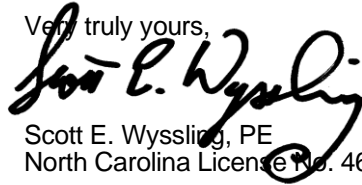

Scott E. Wyssling, PE
North Carolina License No. 46546

THIS PLAN HAS BEEN ELECTRONICALLY SIGNED AND SEALED BY SCOTT WYSSLING, PE USING A DIGITAL SIGNATURE AND DATE. PRINTED COPIES OF THIS DOCUMENT ARE NOT CONSIDERED SIGNED AND SEALED AND THE SIGNATURE MUST BE VERIFIED ON ANY ELECTRONIC COPIES



Wyssling Consulting, PLLC
76 N Meadowbrook Drive Alpine UT 84004
North Carolina COA # P-2308
Signed 6/10/2022

SCOPE OF WORK:

TO INSTALL A ROOF MOUNTED SOLAR PHOTOVOLTAIC SYSTEM AT THE OWNER RESIDENCE LOCATED AT 200 CASTLEBAY DR, SANFORD, NC 27332, USA. THE POWER GENERATED BY THE PV SYSTEM WILL BE INTERCONNECTED WITH THE UTILITY GRID THROUGH THE EXISTING ELECTRICAL SERVICE EQUIPMENT. THE PV SYSTEM DOES NOT INCLUDE STORAGE BATTERIES.

EQUIPMENT SUMMARY

- 25 APTOS DNA-120-MF10-440W MODULES
- 25 ENPHASE IQ8PLUS -72-2-US (240V) MICROINVERTERS

GENERAL NOTES:

- THESE CONSTRUCTION DOCUMENTS HAVE BEEN BASED ON FIELD INSPECTIONS AND OTHER INFORMATION AVAILABLE AT THE TIME. ACTUAL FIELD CONDITIONS MAY REQUIRE MODIFICATIONS IN CONSTRUCTION DETAILS.
- ARCHITECT HAS NOT BEEN RETAINED TO SUPERVISE ANY CONSTRUCTION OR INSTALLATION OF ANY EQUIPMENT AT SITE.
- CONTRACTOR SHALL FURNISH ALL LABOR, MATERIAL, EQUIPMENT, TOOLS, OBTAINS ALL PERMITS, LICENSES AND PAY ALL REQUIRED FEES AND COMPLETE INSTALLATION.
- CONTRACTOR HAS THE FULL RESPONSIBILITY TO CHECK AND VERIFY ALL DIMENSIONS AND EXISTING CONDITIONS. ANY DISCREPANCIES SHALL BE REPORTED TO THE ENGINEER BEFORE PROCEEDING WITH THE WORK. ANY WORK STARTED BEFORE CONSULTATION AND ACCEPTANCE BY THE ENGINEER SHALL BE THE SOLE RESPONSIBILITY OF THE CONTRACTOR AND SHALL BE SUBJECT TO CORRECTION BY THEM WITHOUT ADDITIONAL COMPENSATION.
- DAMAGE CAUSED TO THE EXISTING STRUCTURE, PIPES, DUCTS, WINDOWS, WALL, FLOORS, ETC. SHALL BE REPAIRED TO THE ORIGINAL CONDITION OR REPLACED BY THE CONTRACTOR AT NO ADDITIONAL COST.
- THE CONTRACTOR SHALL BE HELD RESPONSIBLE FOR THE PROPER INSTALLATION AND COMPLETION OF THE WORK WITH APPROVED MATERIALS.
- NO CHANGES ARE TO BE MADE WITHOUT THE CONSULTATION AND APPROVAL OF THE ARCHITECT.
- CONTRACTOR SHALL OBTAIN BUILDING PERMIT. NO WORK TO START UNLESS BUILDING PERMIT IS PROPERLY DISPLAYED.
- ALL WORKMANSHIP AND MATERIALS SHALL BE OF FIRST QUALITY AND IN COMPLIANCE WITH THE REQUIREMENTS OF THE FLORIDA BUILDING CODE, THE DEPARTMENT OF ENVIRONMENTAL PROTECTION AND ALL PERTINENT AGENCIES.
- IT IS ESSENTIAL THAT ALL WORK PROCEED WITH THE MAXIMUM COOPERATION OF ALL PARTIES AND WITH MINIMUM INTERFERENCE TO THE OCCUPANTS WITHIN THE BUILDING. THE OWNER'S DIRECTIONS IN THIS REGARD SHALL BE FULLY COMPLIED WITH.
- ALL EXPOSED PLUMBING, HVAC, ELECTRICAL DUCTWORK, PIPING AND CONDUITS ARE TO BE PAINTED BY GENERAL CONTRACTOR.
- THE CONTRACTOR SHALL PERFORM THE WORK IN STRICT CONFORMANCE WITH THE LOCAL LAWS, REGULATIONS AND THE NATIONAL ELECTRIC CODE.
- THE CONTRACTOR SHALL OBTAIN ALL PERMITS, APPROVALS, AFFIDAVITS, CERTIFICATIONS, ETC. AND PAY ALL FEES AS REQUIRED BY THE LOCAL AUTHORITIES.
- CONTRACTORS SHALL OBTAIN FIRE CERTIF. UPON COMPLETION OF WORK.

ELECTRICAL NOTES:

- ALL EQUIPMENT TO BE LISTED BY UL OR OTHER NRTL, AND LABELED FOR ITS APPLICATION.
- ALL CONDUCTORS SHALL BE COPPER, RATED FOR 600 V AND 90 DEGREE C WET ENVIRONMENT.
- WIRING, CONDUIT, AND RACEWAYS MOUNTED ON ROOFTOPS SHALL BE ROUTED DIRECTLY TO, AND LOCATED AS CLOSE AS POSSIBLE TO THE NEAREST RIDGE, HIP, OR VALLEY.
- WORKING CLEARANCES AROUND ALL NEW AND EXISTING ELECTRICAL EQUIPMENT SHALL COMPLY WITH NEC 110.26.
- WHERE SIZES OF JUNCTION BOXES, RACEWAYS, AND CONDUITS ARE NOT SPECIFIED, THE CONTRACTOR SHALL SIZE THEM ACCORDINGLY.
- ALL WIRE TERMINATIONS SHALL BE APPROPRIATELY LABELED AND READILY VISIBLE.
- MODULE GROUNDING CLIPS TO BE INSTALLED BETWEEN MODULE FRAME AND MODULE SUPPORT RAIL, PER THE GROUNDING CLIP MANUFACTURERS INSTRUCTION.
- MODULE SUPPORT RAIL SHALL BE BONDED TO THE MODULE

GOVERNING CODES

- 2018 INTERNATIONAL FIRE CODE
- 2018 INTERNATIONAL BUILDING CODE
- 2018 INTERNATIONAL RESIDENTIAL CODE
- 2018 NORTH CAROLINA STATE BUILDING CODE
- 2017 NATIONAL ELECTRICAL CODE

AUTHORITY HAVING JURISDICTION (AHJ) : HARNETT COUNTY

WIRING AND CONDUIT NOTES:

- ALL CONDUIT SIZES AND TYPES SHALL BE LISTED FOR ITS PURPOSE AND APPROVAL FOR THE SITE APPLICATIONS
- ALL PV CABLES AND HOMERUN WIRES BE #10AWG *USE-2, PV WIRE, OR PROPRIETARY SOLAR CABLING SPECIFIED BY MFR, OR EQUIVALENT; ROUTED TO SOURCE CIRCUIT COMBINER BOXES AS REQUIRED
- ALL PV DC CONDUCTORS IN CONDUIT EXPOSED TO SUNLIGHT SHALL BE DERATED ACCORDING TO AS PER LATEST NEC CODE.
- EXPOSED ROOF PV DC CONDUCTORS SHALL BE USE-2, 90°C RATED, WET AND UV RESISTANT, AND UL LISTED RATED FOR 600V, UV RATED SPIRAL WRAP SHALL BE USED TO PROTECT WIRE FROM SHARP EDGES
- PHASE AND NEUTRAL CONDUCTORS SHALL BE DUAL RATED THHN/THWN-2 INSULATED, 90°C RATED, WET AND UV RESISTANT, RATED FOR 1000V AS PER APPLICABLE NEC CODE
- 4-WIRE DELTA CONNECTED SYSTEMS HAVE THE PHASE WITH THE HIGHER VOLTAGE TO GROUND MARKED ORANGE OR IDENTIFIED BY OTHER EFFECTIVE MEANS
- ALL SOURCE CIRCUITS SHALL HAVE INDIVIDUAL SOURCE CIRCUIT PROTECTION
- VOLTAGE DROP LIMITED TO 2%
- AC CONDUCTORS >4AWG COLOR CODED OR MARKED: PHASE A OR L1- BLACK, PHASE B OR L2- RED, PHASE C OR L3- BLUE, NEUTRAL- WHITE/GRAY
- VOLTAGE DROP LIMITED TO 2%
- AC CONDUCTORS >4AWG COLOR CODED OR MARKED: PHASE AOR L1- BLACK, PHASE B OR L2- RED, PHASE C OR L3- BLUE, NEUTRAL- WHITE/GRAY

SYSTEM RATING

- 11.00 kWDC
- 7.25 kWAC

SHEET INDEX

PV-0	COVER PAGE
PV-1	SITE PLAN
PV-2	ROOF PLAN & MODULES
PV-3-4	ATTACHMENT DETAILS
PV-5	ELECTRICAL LINE & CALCS.
PV-6	ELECTRICAL PHOTOS
PV-7	SPECIFICATIONS & NOTES
PV-8	LABELS
PV-9	JOB HAZARD ANALYSIS
PV-10+	EQUIPMENT SPECIFICATIONS

PROJECT SITE



1 HOUSE PHOTO

PV-0 SCALE: NTS

THIS PLAN HAS BEEN ELECTRONICALLY SIGNED AND SEALED BY SCOTT WYSSLING, PE USING A DIGITAL SIGNATURE AND DATE. PRINTED COPIES OF THIS DOCUMENT ARE NOT CONSIDERED SIGNED AND SEALED AND THE SIGNATURE MUST BE VERIFIED ON ANY ELECTRONIC COPIES

PROJECT SITE

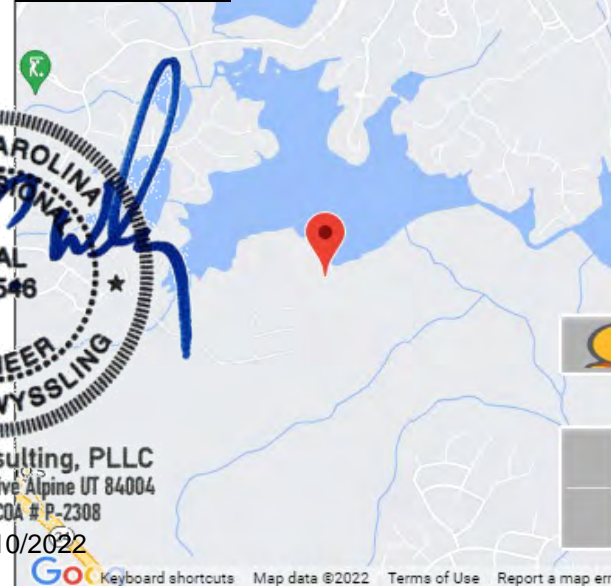

2 VICINITY MAP

PV-0 SCALE: NTS



Wysling Consulting, PLLC
 76 N Meadowbrook Drive Alpine UT 84004
 North Carolina COA # P-2308
 Signed 6/10/2022



LGCY POWER
 3333 DIGITAL DR#600, LEHI, UT 84043, UNITED STATES
 PHONE: (855) 353-4899

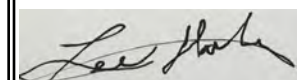

Electrical LIC#: U34871

SYSTEM INFO

- (25) APTOS DNA-120-MF10-440W
- (25) ENPHASE IQ8PLUS -72-2-US (240V)
- DC SYSTEM SIZE: 11.00 kWDC
- AC SYSTEM SIZE: 7.25 kWAC

REVISIONS

DESCRIPTION	DATE	REV

Signature with Seal

PROJECT NAME & ADDRESS

**KENNETH LOKER
 RESIDENCE**
 200 CASTLEBAY DR,
 SANFORD, NC 27332, USA
 PHONE NO. (808) 294-6446
 EMAIL ID: lokerkr@yahoo.com

DATE: 6/10/2022

SHEET NAME
COVER PAGE

SHEET SIZE
**ANSI B
11" X 17"**

SHEET NUMBER

PV-0

SITE NOTES

- A LADDER SHALL BE IN PLACE FOR INSPECTION IN COMPLIANCE WITH OSHA REGULATIONS.
- THE PV MODULES ARE CONSIDERED NON-COMBUSTIBLE AND THIS SYSTEM IS AN UTILITY INTERACTIVE SYSTEM WITH NO STORAGE BATTERIES.
- THE SOLAR PV INSTALLATION SHALL NOT OBSTRUCT ANY PLUMBING, MECHANICAL, OR BUILDING ROOF VENTS.
- PROPER ACCESS AND WORKING CLEARANCE AROUND EXISTING AND PROPOSED ELECTRICAL EQUIPMENT WILL BE PROVIDED AS PER SECTION [NEC 110.26]

LEGEND

	(N) JUNCTION BOX
	(E) UTILITY METER
	(E) MAIN SERVICE PANEL
	(N) ENPHASE IQ COMBINER
	(N) NON FUSED AC DISCONNECT
	VENT, ATTIC FAN (ROOF OBSTRUCTION)
	ROOF ATTACHMENT
	CONDUIT
	ENPHASE IQ8PLUS -72-2-US (240V) MICROINVERTER
	APTOS DNA-120-MF10-440W MODULES
	UNIRAC SOLARMOUNT LIGHT
	RAIL 168" MILL
	TRENCH

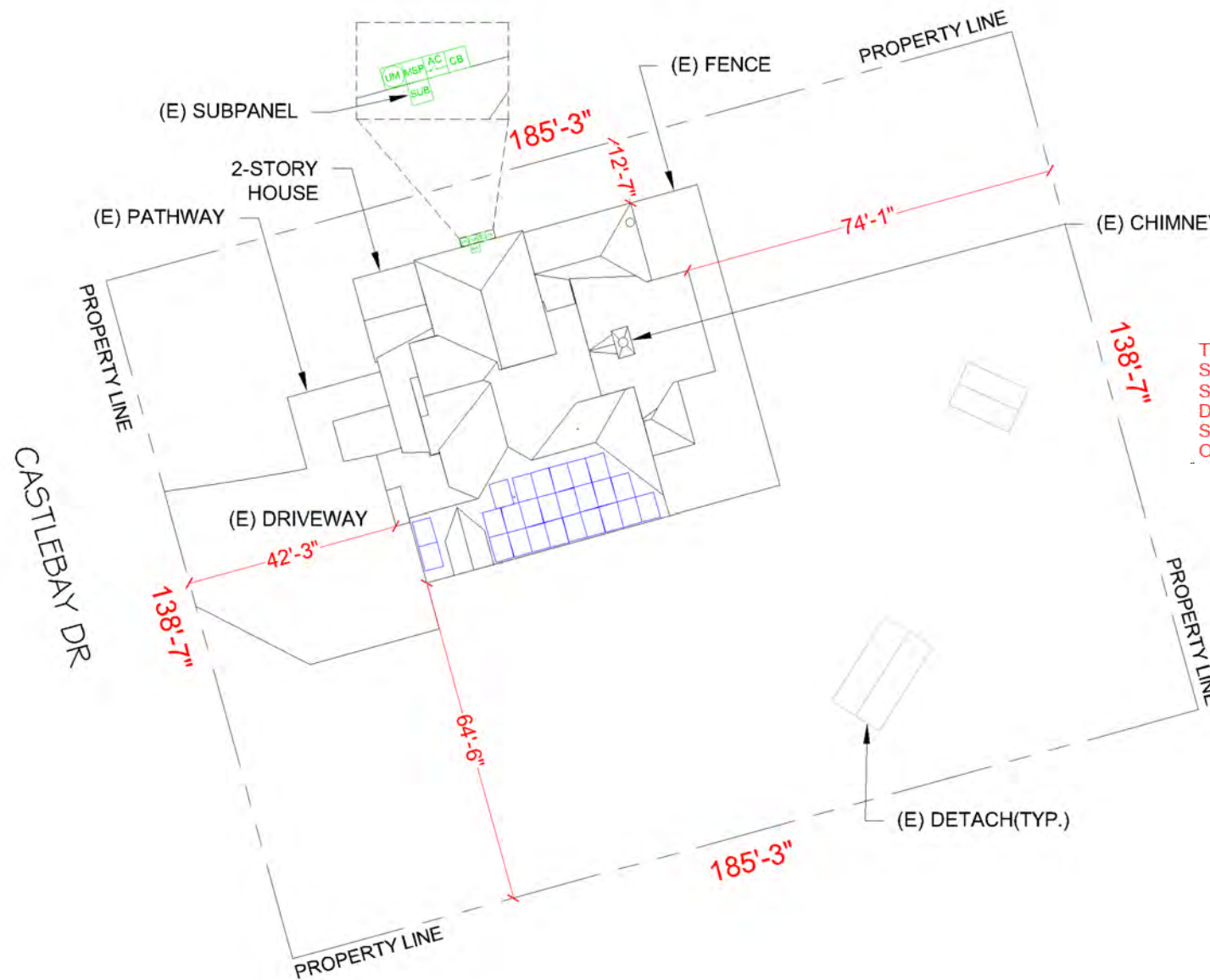

THIS PLAN HAS BEEN ELECTRONICALLY SIGNED AND SEALED BY SCOTT WYSSLING, PE USING A DIGITAL SIGNATURE AND DATE. PRINTED COPIES OF THIS DOCUMENT ARE NOT CONSIDERED SIGNED AND SEALED AND THE SIGNATURE MUST BE VERIFIED ON ANY ELECTRONIC COPIES



Wyssling Consulting, PLLC
 76 N Meadowbrook Drive Alpine UT 84004
 North Carolina COA # P-2308
 Signed 6/10/2022



LGCY POWER
 3333 DIGITAL DR#600, LEHI,
 UT 84043, UNITED STATES
 PHONE: (855) 353-4899

Lee Hoke

Electrical LIC#: U34871

SYSTEM INFO

(25) APTOS
 DNA-120-MF10-440W
 (25) ENPHASE
 IQ8PLUS -72-2-US (240V)
 DC SYSTEM SIZE: 11.00 kWDC
 AC SYSTEM SIZE: 7.25 kWAC

REVISIONS

DESCRIPTION	DATE	REV

Signature with Seal

PROJECT NAME & ADDRESS

KENNETH LOKER
 RESIDENCE
 200 CASTLEBAY DR,
 SANFORD, NC 27332, USA
 PHONE NO. (808) 294-6446
 EMAIL ID: lokerkr@yahoo.com

DATE: 6/10/2022

SHEET NAME
 SITE PLAN

SHEET SIZE

ANSI B
 11" X 17"

SHEET NUMBER

PV-1



SCALE: 1/32"= 1'-0"

METER NO#: 161 766 392

DESIGN SPECIFICATION	
RISK CATEGORY:	II
CONSTRUCTION:	SFD
ZONING:	RESIDENTIAL
SNOW LOAD (ASCE7-10):	15 PSF
EXPOSURE CATEGORY:	C
WIND SPEED (ASCE7-10):	115 MPH

INVERTER SPECIFICATIONS	
MANUFACTURER / MODEL	ENPHASE IQ8PLUS -72-2-US (240V)
MAX DC SHORT CIRCUIT CURRENT	15 A
CONTINUOUS OUTPUT CURRENT	1.21 A

ROOF DESCRIPTION					
ROOF #	ROOF TILT	AZIMUTH	RAFTER SIZE	RAFTER SPACING	ROOF MATERIAL
#1	38°	164°	2" x 8"	16" o.c.	COMP SHINGLE

ARRAY AREA & ROOF AREA CALC'S		
ROOF	# OF MODULES	ARRAY AREA (Sq. Ft.)
#1	25	580.77
(TOTAL ARRAY AREA/TOTAL ROOF AREA) X 100%		
= (580.77/3624.66) X 100% = 16.03%		

MODULE TYPE, DIMENSIONS & WEIGHT	
NUMBER OF MODULES:	25 MODULES
MODULE TYPE:	APTOS DNA-120-MF10-440W
MODULE WEIGHT:	52.9 LBS
MODULE DIMENSIONS:	74.92" X 44.65" = 23.23 SF
UNIT WEIGHT OF AREA:	2.28 PSF

LEGEND	
	(N) JUNCTION BOX
	(E) UTILITY METER
	(E) MAIN SERVICE PANEL
	(N) ENPHASE IQ COMBINER
	(N) NON FUSED AC DISCONNECT
	VENT, ATTIC FAN (ROOF OBSTRUCTION)
	ROOF ATTACHMENT
	CONDUIT
	ENPHASE IQ8PLUS -72-2-US (240V) MICROINVERTER
	APTOS DNA-120-MF10-440W MODULES
	UNIRAC SOLARMOUNT LIGHT
	RAIL 168" MILL
	TRENCH
PANEL HEIGHT OFF ROOF	5"

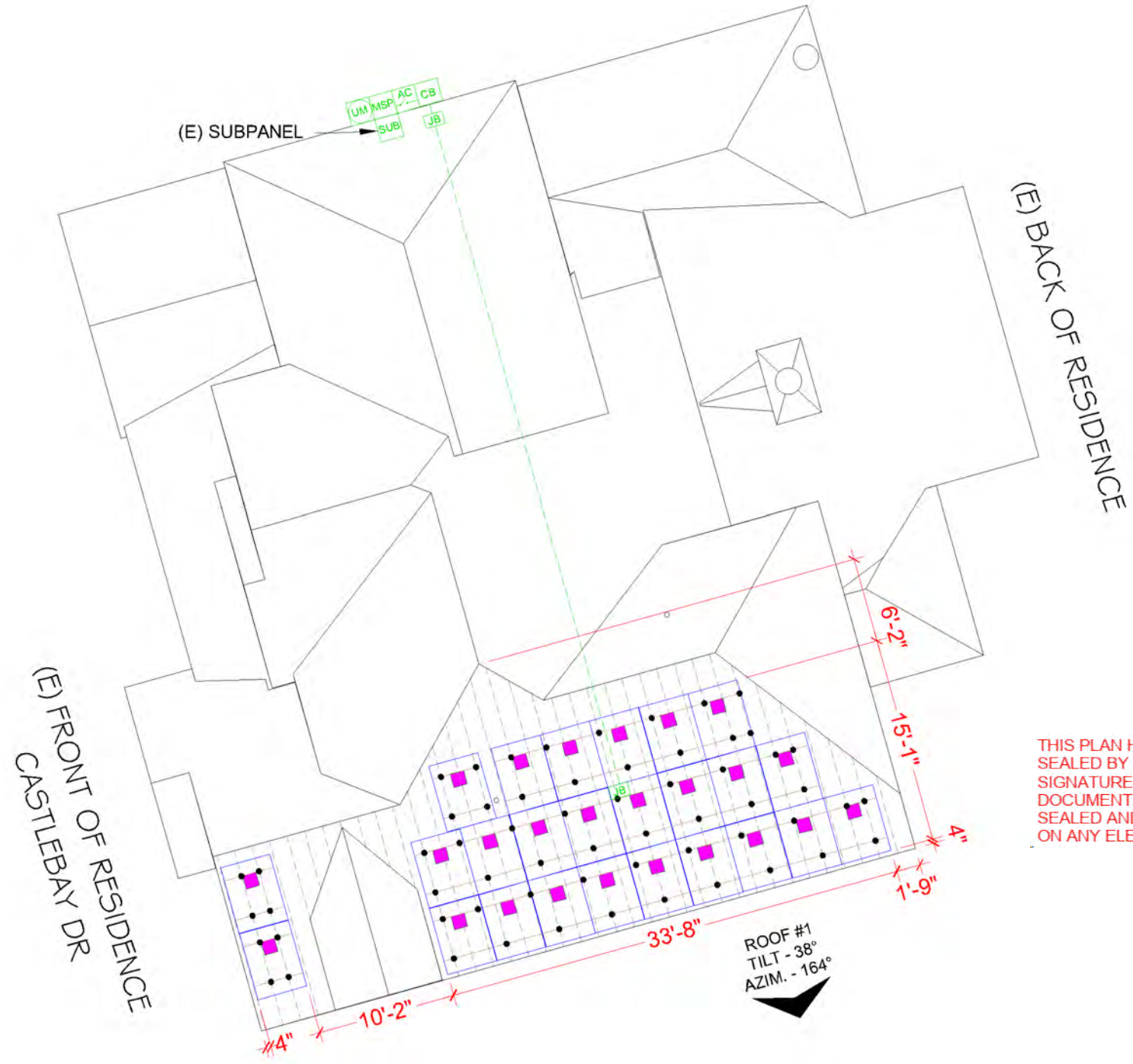

THIS PLAN HAS BEEN ELECTRONICALLY SIGNED AND SEALED BY SCOTT WYSSLING, PE USING A DIGITAL SIGNATURE AND DATE. PRINTED COPIES OF THIS DOCUMENT ARE NOT CONSIDERED SIGNED AND SEALED AND THE SIGNATURE MUST BE VERIFIED ON ANY ELECTRONIC COPIES



Wyssling Consulting, PLLC
 76 N Meadowbrook Drive Alpine UT 84004
 North Carolina CQA # P-2308
 Signed 6/10/2022

LGCY POWER
 LGCY POWER
 3333 DIGITAL DR#600, LEHI, UT 84043, UNITED STATES
 PHONE: (855) 353-4899

 Electrical LIC#: U34871

SYSTEM INFO		
(25) APTOS DNA-120-MF10-440W		
(25) ENPHASE IQ8PLUS -72-2-US (240V)		
DC SYSTEM SIZE: 11.00 kWDC		
AC SYSTEM SIZE: 7.25 kWAC		

REVISIONS		
DESCRIPTION	DATE	REV

Signature with Seal

PROJECT NAME & ADDRESS
KENNETH LOKER RESIDENCE
 200 CASTLEBAY DR,
 SANFORD, NC 27332, USA
 PHONE NO. (808) 294-6446
 EMAIL ID: lokerkr@yahoo.com

DATE: 6/10/2022
SHEET NAME ROOF PLAN & MODULES
SHEET SIZE ANSI B 11" X 17"
SHEET NUMBER PV-2



SCALE: 1/8" = 1'-0"

METER NO#: 161 766 392

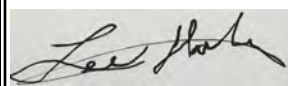

Electrical LIC#: U34871

SYSTEM INFO

(25) APTOS
 DNA-120-MF10-440W
 (25) ENPHASE
 IQ8PLUS -72-2-US (240V)
 DC SYSTEM SIZE: 11.00 kWDC
 AC SYSTEM SIZE: 7.25 kWAC

REVISIONS

DESCRIPTION	DATE	REV

Signature with Seal

PROJECT NAME & ADDRESS

KENNETH LOKER
 RESIDENCE
 200 CASTLEBAY DR,
 SANFORD, NC 27332, USA
 PHONE NO. (808) 294-6446
 EMAIL ID: lokerkr@yahoo.com

DATE: 6/10/2022

SHEET NAME
**ATTACHMENT
 DETAILS**

SHEET SIZE
**ANSI B
 11" X 17"**

SHEET NUMBER

PV-3

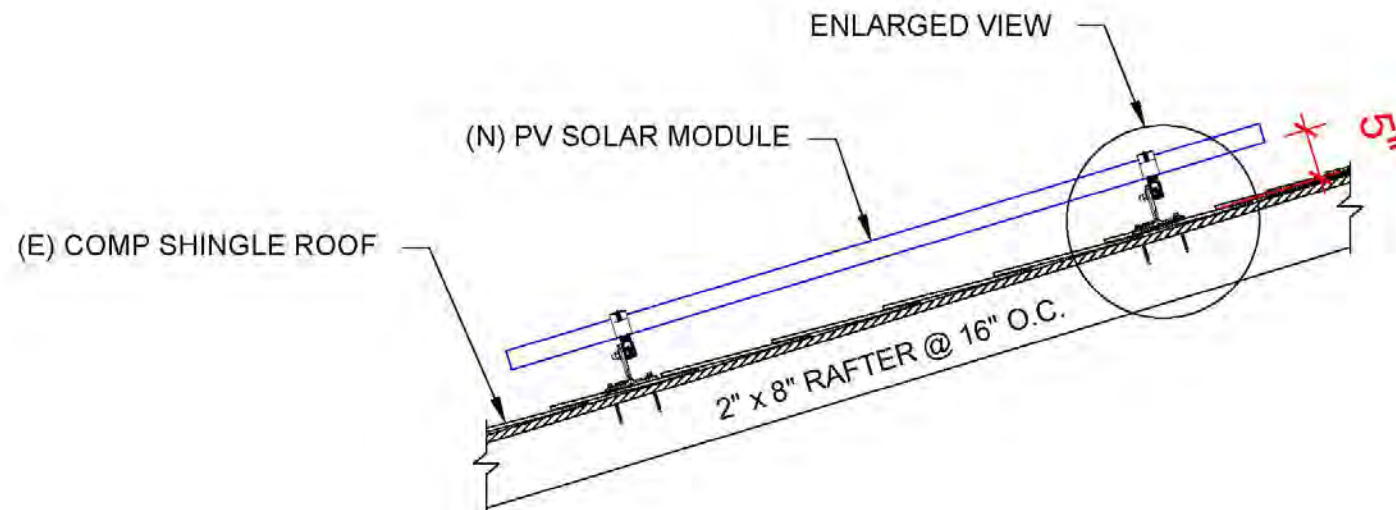

THIS PLAN HAS BEEN ELECTRONICALLY SIGNED AND SEALED BY SCOTT WYSSLING, PE USING A DIGITAL SIGNATURE AND DATE. PRINTED COPIES OF THIS DOCUMENT ARE NOT CONSIDERED SIGNED AND SEALED AND THE SIGNATURE MUST BE VERIFIED ON ANY ELECTRONIC COPIES



Wyssling Consulting, PLLC
 76 N Meadowbrook Drive Alpine UT 84004
 North Carolina COA # P-2308
 Signed 6/10/2022

1 ATTACHMENT DETAILS

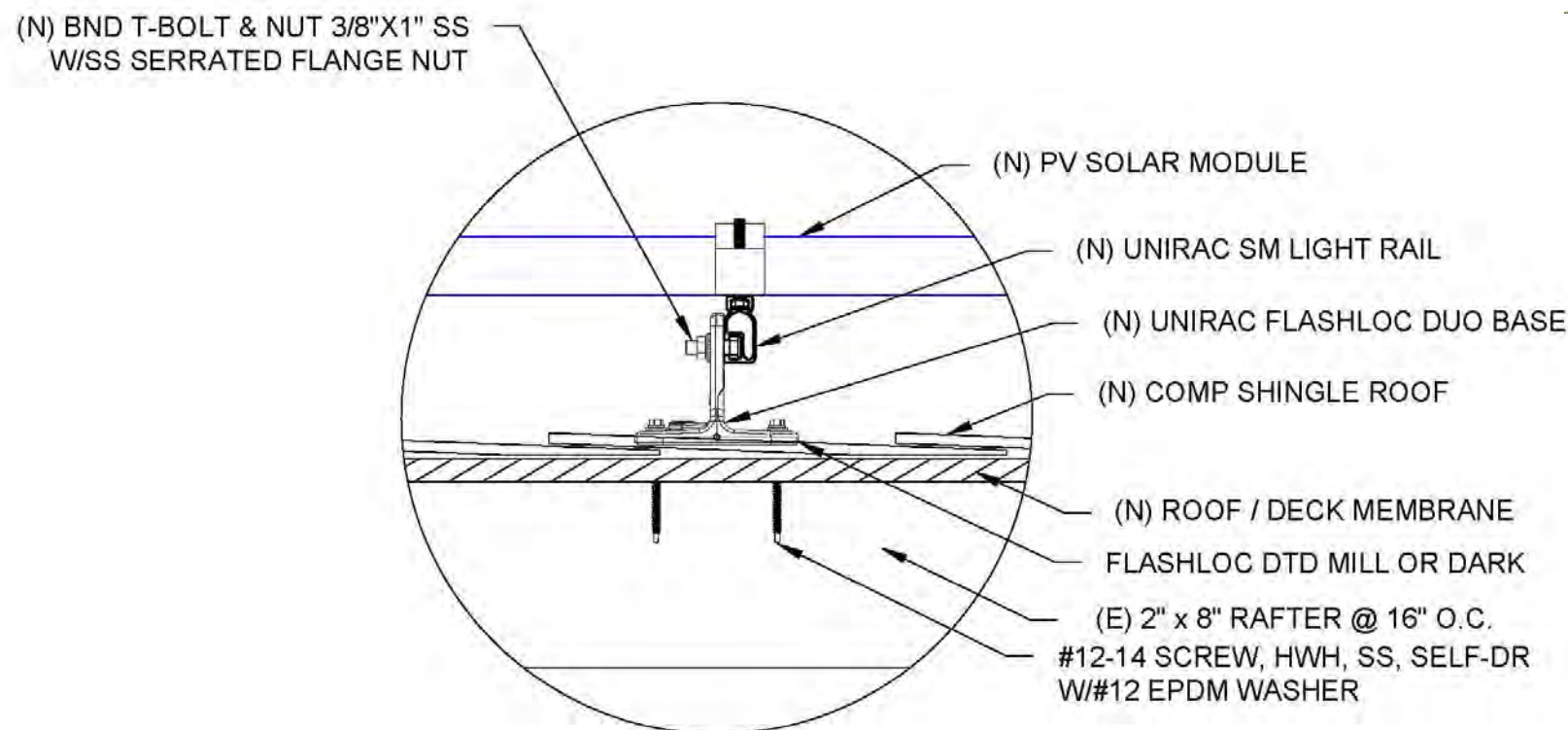

2 ENLARGED VIEW OF ATTACHMENT

SCALE: NTS

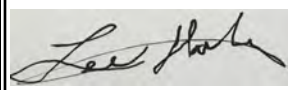

Electrical LIC#: U34871

SYSTEM INFO

(25) APTOS
DNA-120-MF10-440W
(25) ENPHASE
IQ8PLUS -72-2-US (240V)
DC SYSTEM SIZE: 11.00 kWDC
AC SYSTEM SIZE: 7.25 kWAC

REVISIONS

DESCRIPTION	DATE	REV

Signature with Seal

PROJECT NAME & ADDRESS

KENNETH LOKER
RESIDENCE
200 CASTLEBAY DR,
SANFORD, NC 27332, USA
PHONE NO. (808) 294-6446
EMAIL ID: lokerkr@yahoo.com

DATE: 6/10/2022

SHEET NAME
**ATTACHMENT
DETAILS**

SHEET SIZE
**ANSI B
11" X 17"**

SHEET NUMBER

PV-4

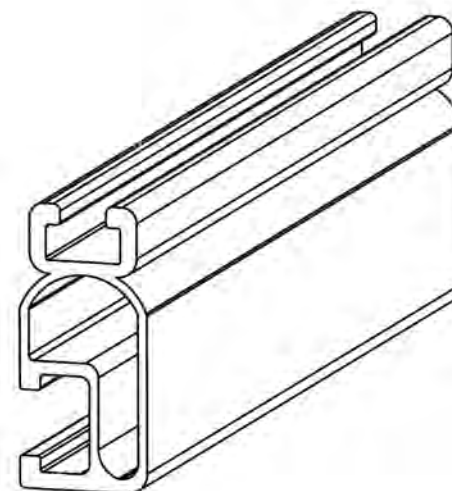

1/4" BOLT LOCATION

3/8" BOLT LOCATION

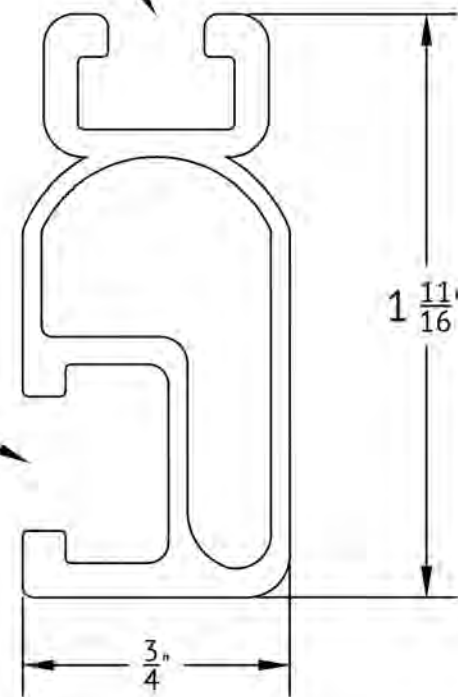

THIS PLAN HAS BEEN ELECTRONICALLY SIGNED AND SEALED BY SCOTT WYSSLING, PE USING A DIGITAL SIGNATURE AND DATE. PRINTED COPIES OF THIS DOCUMENT ARE NOT CONSIDERED SIGNED AND SEALED AND THE SIGNATURE MUST BE VERIFIED ON ANY ELECTRONIC COPIES



Wyssling Consulting, PLLC
76 N Meadowbrook Drive Alpine UT 84004
North Carolina COA # P-2308
Signed 6/10/2022

UNIRAC
1411 BROADWAY BLVD NE
ALBUQUERQUE, NM 87102 USA
WWW.UNIRAC.COM

PRODUCT LINE: SOLARMOUNT
DRAWING TYPE: PART DETAIL
DESCRIPTION: LIGHT RAIL
REVISION DATE: APRIL 2016

DRAWING NOT TO SCALE
ALL DIMENSIONS ARE NOMINAL

PRODUCT PROTECTED BY ONE
OR MORE US PATENTS

LEGAL NOTICE

SM-P02

SHEET

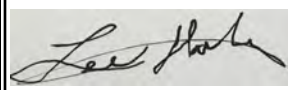

Electrical LIC#: U34871

SYSTEM INFO		
(25) APTOS	DNA-120-MF10-440W	
(25) ENPHASE	IQ8PLUS-72-2-US (240V)	
DC SYSTEM SIZE:	11.00 kWDC	
AC SYSTEM SIZE:	7.25 kWAC	

REVISIONS		
DESCRIPTION	DATE	REV

Signature with Seal

PROJECT NAME & ADDRESS

KENNETH LOKER
RESIDENCE
 200 CASTLEBAY DR,
 SANFORD, NC 27332, USA
 PHONE NO. (808) 294-6446
 EMAIL ID: lokerkr@yahoo.com

DATE: 6/10/2022

SHEET NAME
ELECTRICAL
LINE & CALCS.

SHEET SIZE
ANSI B
11" X 17"

SHEET NUMBER

PV-5

ID	TYPICAL	INITIAL CONDUCTOR LOCATION	FINAL CONDUCTOR LOCATION	CONDUCTOR			CONDUIT	# OF PARALLEL CIRCUITS	CURRENT-CARRYING CONDUCTORS IN CIRCUIT	CONDUIT FILL PERCENT	OCPD	EGC		TEMP. CORR. FACTOR		CONDUIT FILL FACTOR	CONT. CURRENT	MAX. CURRENT	BASE AMP.	DERATED AMP.	TERM. TEMP. RATING	LENGTH	VOTAGE DROP
				6 AWG	BARE COPPER	0.71						(56°C)											
1	2	ARRAY	JUNCTION BOX	12 AWG	Q CABLE	-	-	1	2	N/A	N/A	6 AWG	BARE COPPER	0.71	(56°C)	N/A	15.73A	19.66A	N/A	N/A	90°C	61FT	0.76%
2	1	JUNCTION BOX	JUNCTION BOX 1	12-2 GAUGE	ROMEX	-	-	1	2	N/A	N/A	6 AWG	BARE COPPER	0.71	(56°C)	N/A	15.73A	19.66A	N/A	N/A	90°C	50FT	0.76%
3	1	JUNCTION BOX 1	IQ COMBINER BOX	10 AWG	THWN 2	COPPER	MIN 0.75" DIA EMT*	2	4	24.20%	20A	10 AWG	THWN-2 COPPER	0.96	(34°C)	0.8	15.73A	19.66A	40A	30.72A	90°C	22FT	0.37%
4	1	IQ COMBINER BOX	NON FUSED AC DISCONNECT	8 AWG	THWN 2	COPPER	MIN 0.75" DIA EMT*	1	3	29.46%	N/A	10 AWG	THWN-2 COPPER	0.96	(34°C)	1	30.25A	37.81A	55A	52.80A	90°C	5FT	0.10%
5	1	NON FUSED AC DISCONNECT	MSP	8 AWG	THWN 2	COPPER	MIN 0.75" DIA EMT*	1	3	29.46%	40A	10 AWG	THWN-2 COPPER	0.96	(34°C)	1	30.25A	37.81A	55A	52.80A	90°C	5FT	0.10%

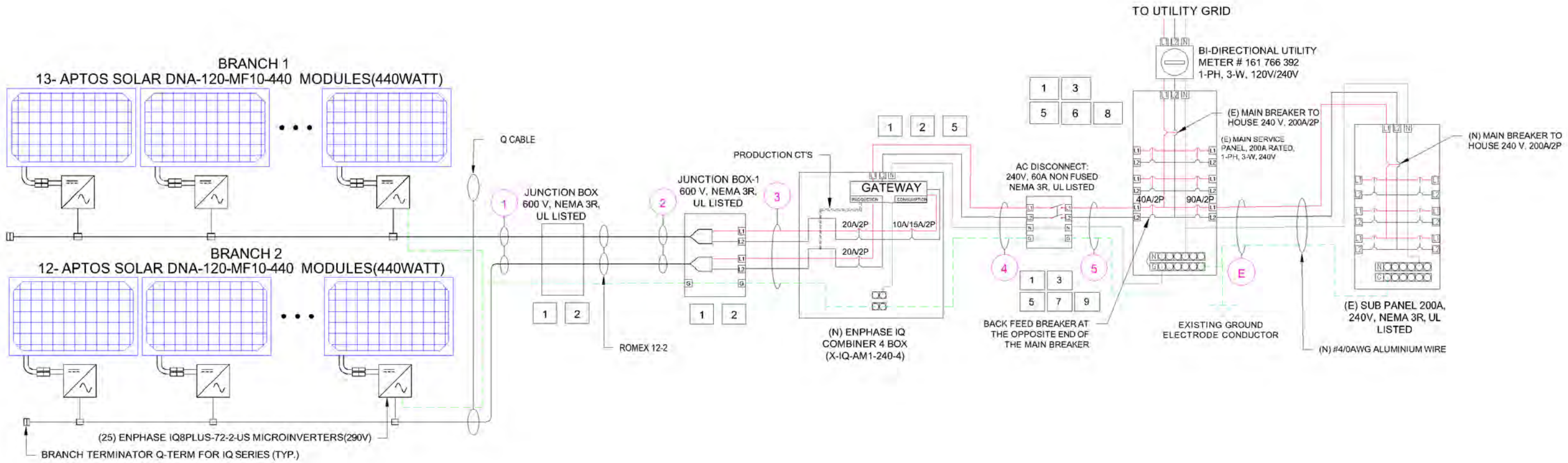

SCALE: NTS

INTERCONNECTION 120% RULE - NEC 705.12(B)(2)(3)(b)
UTILITY FEED + SOLAR BACKFEED 200A + 40A = 240A
BUSS RATING X 120% 200A x 120% = 240A

SERVICE INFO	
UTILITY PROVIDER:	CENTRAL EMC
AHJ NAME:	HARNETT COUNTY
MAIN SERVICE VOLTAGE:	240V
MAIN PANEL BRAND:	EATON
MAIN SERVICE PANEL:	200A
MAIN BREAKER RATING:	200A
MAIN SERVICE LOCATION:	NORTH
SERVICE FEED SOURCE:	UNDERGROUND

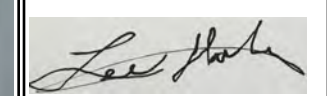
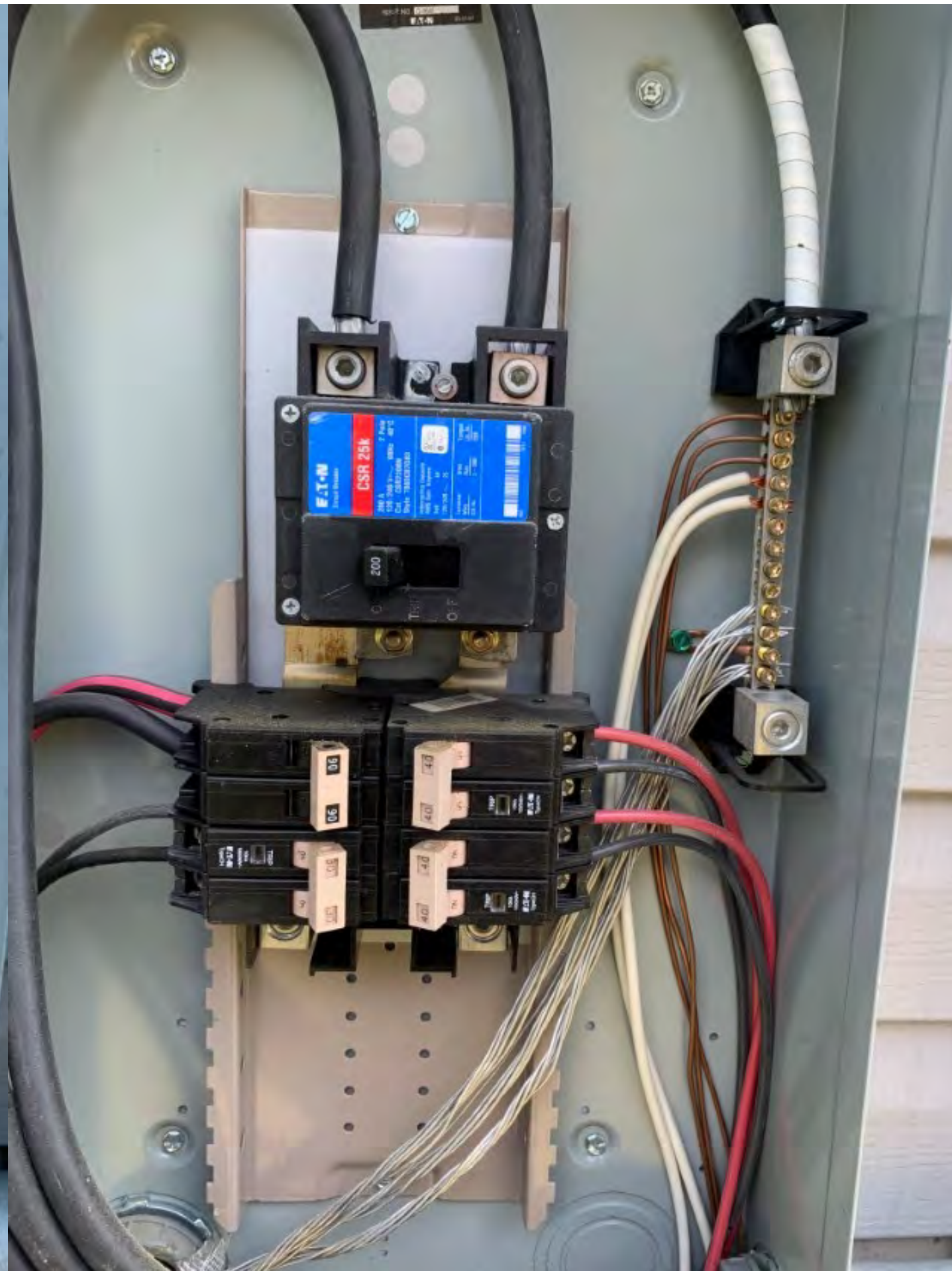

Electrical LIC#: U34871

SYSTEM INFO		
(25) APTOS	DNA-120-MF10-440W	
(25) ENPHASE	IQ8PLUS -72-2-US (240V)	
DC SYSTEM SIZE: 11.00 kWDC		
AC SYSTEM SIZE: 7.25 kWAC		

REVISIONS		
DESCRIPTION	DATE	REV

Signature with Seal

PROJECT NAME & ADDRESS

**KENNETH LOKER
RESIDENCE
200 CASTLEBAY DR,
SANFORD, NC 27332, USA
PHONE NO. (808) 294-6446
EMAIL ID: lokerkr@yahoo.com**

DATE: 6/10/2022

SHEET NAME
**ELECTRICAL
PHOTOS**

SHEET SIZE
**ANSI B
11" X 17"**

SHEET NUMBER
PV-6

SOLAR MODULE SPECIFICATIONS	
MANUFACTURER / MODEL	APTOS DNA-120-MF10-440W
VMP	33.82 V
IMP	13.01 A
VOC	40.8 V
ISC	13.61 A
TEMP. COEFF. VOC	-0.31%/K
PTC RATING	406 W
MODULE DIMENSION	74.92"(L) x 44.65"(W)
PANEL WATTAGE	440 W

INVERTER SPECIFICATIONS	
MANUFACTURER / MODEL	ENPHASE IQ8PLUS -72-2-US (240V)
MAX DC SHORT CIRCUIT CURRENT	15 A
CONTINUOUS OUTPUT CURRENT	1.21 A

AMBIENT TEMPERATURE SPECS	
RECORD LOW TEMP	-13°C
AMBIENT TEMP (HIGH TEMP 2%)	34°C
CONDUIT HEIGHT	7/8"
ROOF TOP TEMP	90°C
CONDUCTOR TEMPERATURE RATE	56°C
MODULE TEMPERATURE COEFFICIENT OF VOC	-0.31%/K

PERCENT OF VALUES	NUMBER OF CURRENT CARRYING CONDUCTORS IN EMT
0.80	4-6
0.70	7-9
0.50	10-20

Voltage rise in Q Cable from the Microinverters to the Junction Box

For branch circuit #1 of 13 IQ 8+ Micros, the voltage rise on the 240 VAC Q Cable is 0.76%
 For branch circuit #2 of 12 IQ 8+ Micros, the voltage rise on the 240 VAC Q Cable is 0.65%

Voltage rise from the Junction Box 1 to the IQ Combiner Box

VRise = (amps/inverter x number of inverters) x (resistance in ohms/ft.) x (2-way wire length in ft.)
 = (1.21 amp x 13) x (0.00129 ohms/ft) x (22 ft x 2)
 = 15.73 amps x 0.00129 ohms/ft) x 44 ft
 = 0.89 volts

%VRise = 0.89 volts ÷ 240 volts = 0.37%
 The voltage rise from the Junction Box 1 to the IQ Combiner Box is 0.37%

Voltage rise from the IQ Combiner Box to the Non Fused AC Disconnect

VRise = (amps/inverter x number of inverters) x (resistance in ohms/ft.) x (2-way wire length in ft.)
 = (1.21 amp x 25) x (0.000809 ohms/ft) x (5 ft x 2)
 = 30.25 amps x 0.000809 ohms/ft) x 10 ft
 = 0.24 volts

%VRise = 0.24 volts ÷ 240 volts = 0.10%
 The voltage rise from the IQ Combiner Box to the Non Fused AC Disconnect is 0.10%

Voltage rise from the Non Fused AC Disconnect to the MSP

VRise = (amps/inverter x number of inverters) x (resistance in ohms/ft.) x (2-way wire length in ft.)
 = (1.21 amp x 25) x (0.000809 ohms/ft) x (5 ft x 2)
 = 30.25 amps x 0.000809 ohms/ft) x 10 ft
 = 0.24 volts

%VRise = 0.24 volts ÷ 240 volts = 0.10%
 The voltage rise from the Non Fused AC Disconnect to the MSP is 0.10%

Total system voltage rise for all wire sections

0.76% + 0.37% + 0.1% + 0.1% = 1.33%

LGCY POWER
 LGCY POWER
 3333 DIGITAL DR#600, LEHI,
 UT 84043, UNITED STATES
 PHONE: (855) 353-4899



Electrical LIC#: U34871

SYSTEM INFO
(25) APTOS DNA-120-MF10-440W
(25) ENPHASE IQ8PLUS -72-2-US (240V)
DC SYSTEM SIZE: 11.00 kWDC
AC SYSTEM SIZE: 7.25 kWAC

REVISIONS		
DESCRIPTION	DATE	REV

Signature with Seal

PROJECT NAME & ADDRESS

KENNETH LOKER
 RESIDENCE
 200 CASTLEBAY DR,
 SANFORD, NC 27332, USA
 PHONE NO. (808) 294-6446
 EMAIL ID: lokerkr@yahoo.com

DATE: 6/10/2022
SHEET NAME SPECIFICATIONS & NOTES
SHEET SIZE ANSI B 11" X 17"
SHEET NUMBER PV-7

1

⚠ WARNING

ELECTRIC SHOCK HAZARD

TERMINALS ON BOTH LINE AND LOAD SIDES MAY BE ENERGIZED IN THE OPEN POSITION

LABEL LOCATION:
MAIN SERVICE PANEL/AC DISCONNECT/AC COMBINER
(PER CODE: NEC 706.15(C)(4), 690.13(B), NEC2020)

2

WARNING PHOTOVOLTAIC POWER SOURCE

LABEL LOCATION:
DC CONDUIT
EVERY 10' AND ON CONDUIT BODIES WHEN EXPOSED
(PER CODE: NEC2020 690.31(O)(2), 690.31(D)(2), NEC2020)

3

PHOTOVOLTAIC AC DISCONNECT

RATED AC OUTPUT CURRENT 30.25 A

NOMINAL OPERATING AC VOLTAGE 240 VAC

LABEL LOCATION:
MAIN SERVICE PANEL/AC DISCONNECT
690.54, NEC2020

4

RAPID SHUTDOWN SWITCH FOR SOLAR PV SYSTEM

LABEL LOCATION:
INVERTER
AT OR WITHIN 3' OF THE DC COMBINER SWITCH
PER CODE: NEC 690.56(C)(2), NEC2020

5

⚠ CAUTION

DUAL POWER SOURCE

SECOND SOURCE IS PHOTOVOLTAIC SYSTEM

LABEL LOCATION:
MAIN SERVICE PANEL/AC DISCONNECT/AC COMBINER/REVENUE METER
2017 NEC 705.12(C) & NEC 690.59

ADHESIVE FASTENED SIGNS:

- ANSI Z535.4-2011 PRODUCT SAFETY SIGNS AND LABELS, PROVIDES GUIDELINES FOR SUITABLE FONT SIZES, WORDS, COLORS, SYMBOLS, AND LOCATION REQUIREMENTS FOR LABELS. NEC 110.21(B)(1)
- THE LABEL SHALL BE OF SUFFICIENT DURABILITY TO WITHSTAND THE ENVIRONMENT INVOLVED. NEC 110.21(B)(3).
- ADHESIVE FASTENED SIGNS MAY BE ACCEPTABLE IF PROPERLY ADHERED. VINYL SIGNS SHALL BE WEATHER RESISTANT.

6

SOLAR PV SYSTEM EQUIPPED WITH RAPID SHUTDOWN

TURN RAPID SHUTDOWN SWITCH TO THE 'OFF' POSITION TO SHUT DOWN PV SYSTEM AND REDUCE SHOCK HAZARD IN THE ARRAY

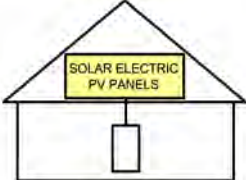

MAIN SERVICE PANEL
IF MSD IS OUTSIDE PLACE IT THERE / IF MSD IS INSIDE PLACE ON THE AC DISCONNECT
PER CODE: IFC 605.11.3.1(1) & NEC 690.56(C), NEC2020

7

PHOTOVOLTAIC SYSTEM UTILITY DISCONNECT SWITCH

LABEL LOCATION:
AC DISCONNECT
2017 NEC 690.13(B)

8

PV SOLAR BREAKER

DO NOT RELOCATE THIS OVERCURRENT DEVICE

LABEL LOCATION:
MAIN SERVICE PANEL
2017 NEC 705.12 (B)(3)(2)

9

SERVICE DISCONNECT

SECTIONNEUR PRINCIPALE

SERVICIO DE DESCONEXION

LABEL LOCATION:
AC DISCONNECT
2017 NEC 230.66

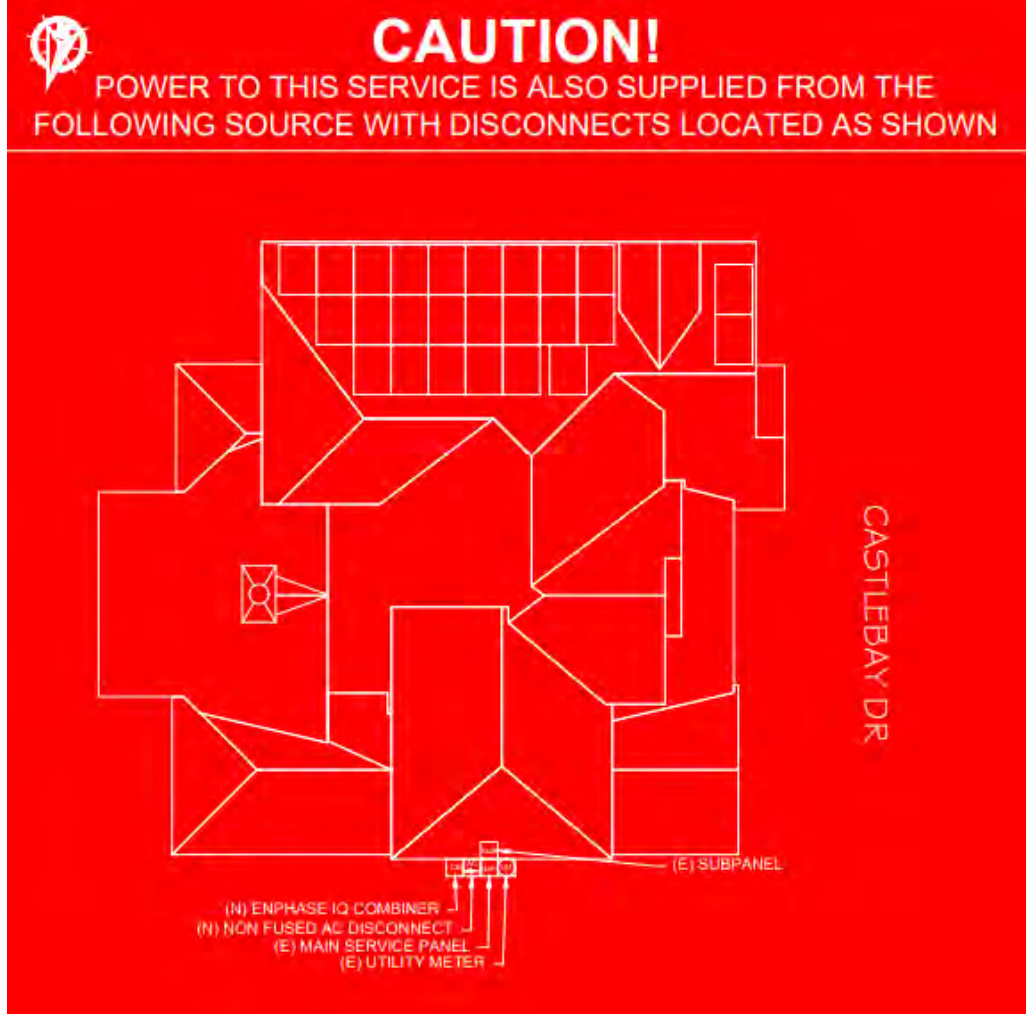

LGCY POWER

LGCY POWER
3333 DIGITAL DR#600, LEHI, UT 84043, UNITED STATES
PHONE: (855) 353-4899



Electrical LIC#: U34871

SYSTEM INFO		
(25) APTOS	DNA-120-MF10-440W	
(25) ENPHASE	IQ8PLUS -72-2-US (240V)	
DC SYSTEM SIZE:	11.00 kWDC	
AC SYSTEM SIZE:	7.25 kWAC	

REVISIONS		
DESCRIPTION	DATE	REV

Signature with Seal

PROJECT NAME & ADDRESS

KENNETH LOKER RESIDENCE
200 CASTLEBAY DR,
SANFORD, NC 27332, USA
PHONE NO. (808) 294-6446
EMAIL ID: lokerkr@yahoo.com

DATE: 6/10/2022

SHEET NAME
LABELS

SHEET SIZE
**ANSI B
11" X 17"**

SHEET NUMBER
PV-8



FIELD DESIGN REQUEST FORM

JOB HAZARD ANALYSIS

JOB INFORMATION	
JOB NAME:	
ADDRESS:	

CUSTOMER NAME/JOB ID: _____
 CUSTOMER ADDRESS: _____
 INSTALL DATE: ____-____-____ TIME: ____ am/pm

CHANGE REQUEST:

WHO AUTHORIZED THE CHANGE: _____

DESCRIBE THE NEEDED CHANGE & WHY: _____

NEW DESIGN LAYOUT:

DRAW THE MOUNTING PLANE SHOWING THE NEW MODULE LAYOUT:

INSTALLER NAME (PRINT) _____

I UNDERSTAND AND AGREE TO THE CHANGES MADE ABOVE

CUSTOMER NAME _____ CUSTOMER SIGNATURE _____ DATE _____

HAZARD CATEGORY	HAZARD TYPE	HAZARD CONTROL MEASURES
LADDER SAFETY	<ul style="list-style-type: none"> • LOCATION • CONDITION • WORKING CLEARANCE 	
FALL PROTECTION	<ul style="list-style-type: none"> • WORKING 6' OR HIGHER 	
ELECTRICAL SAFETY	<ul style="list-style-type: none"> • ARCH FLASH • ELECTRIC • SHOCK/ELECTROCUTION 	
WEATHER CONDITIONS	<ul style="list-style-type: none"> • HEAT/COLD TEMP • RAINY/ICY/WINDY 	
PUBLIC SAFETY	<ul style="list-style-type: none"> • WORK/OBJECTS OVERHEAD • SLIPS/TRIPS/FALLS • ACCESS TO LIVE ELECTRICAL 	

NEAREST EMERGENCY FACILITY _____

CONTACT IMMEDIATELY IN EMERGENCY (911 AND/OR) _____

GENERAL SITE DESCRIPTION/NOTES

CREW MEMBERS ON SITE FOR INSTALL

NAME	SIGNATURE
FMU/LMD-	

ELECTRICAL COMPLETION PHOTOS QR CODE



ROOFTOP INSTALLATION PHOTOS QR CODE



MPU COMPLETION PHOTOS QR CODE



LGCY POWER
 3333 DIGITAL DR#600, LEHI,
 UT 84043, UNITED STATES
 PHONE: (855) 353-4899

Electrical LIC#: U34871

SYSTEM INFO

(25) APTOS
DNA-120-MF10-440W
(25) ENPHASE
IQ8PLUS -72-2-US (240V)
DC SYSTEM SIZE: 11.00 kWDC
AC SYSTEM SIZE: 7.25 kWAC

REVISIONS

DESCRIPTION	DATE	REV

Signature with Seal

PROJECT NAME & ADDRESS

KENNETH LOKER
 RESIDENCE
 200 CASTLEBAY DR,
 SANFORD, NC 27332, USA
 PHONE NO. (808) 294-6446
 EMAIL ID: lokerkr@yahoo.com

DATE: 6/10/2022

SHEET NAME
JOB HAZARD ANALYSIS

SHEET SIZE
ANSI B
11" X 17"

SHEET NUMBER
PV-9

DNA™ 120

Solar for Innovators

DNA™ 120

Residential | Commercial

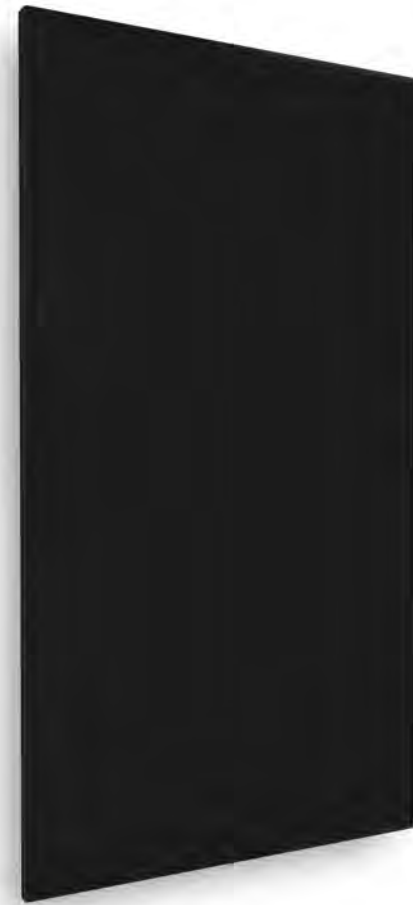

Designed & Engineered in Silicon Valley 440W | 435W | 430W

Our DNA Split Cell Series uses advanced selective emitter PERC technology with thin film layers to improve heat tolerance, increase photon capture, minimize resistive loss, and use 5% more of the available active area for optimal power performance. Our panels exceed IEC standards and come with an industry leading, 30-year warranty.

Linear Performance Warranty

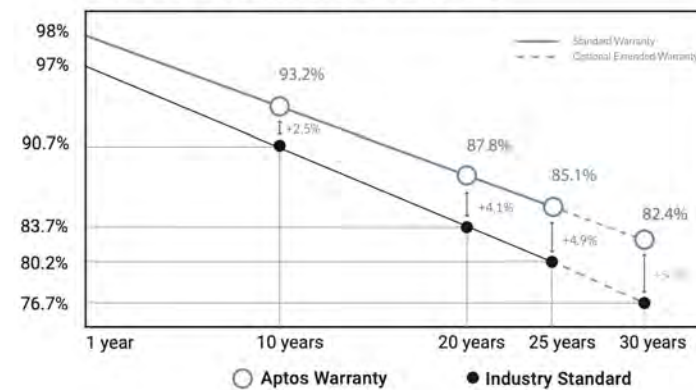

Features



Advanced Technology

Patented DNA™ technology boosts power performance & module efficiency



Maximum Panel Density

Advanced split cell technology with 9 ultra-thin busbars allows for less resistance and more photon capture



Durable Design

Robust product design is resilient in extreme weather. Up to 5400 Pa snow load and 5400 Pa wind load



A Safe Investment

Industry leading 30 year warranty



3140 De La Cruz Blvd., Ste 200
Santa Clara, CA 95054
www.aptosolar.com | info@aptossolar.com

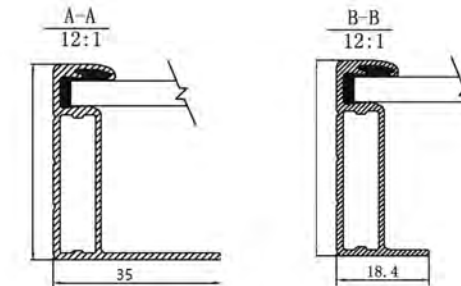

Electrical Specifications

	DNA-120-MF10-440W	DNA-120-MF10-445W	DNA-120-MF10-440W
STC Rated Output P _{max} (W)	440W	445W	450W
Module Efficiency	20.39%	20.62%	20.85%
Open Circuit Voltage V _{OC} (V)	40.80	41.10	41.34
Short Circuit Current I _{SC} (A)	13.61	13.70	13.80
Rated Voltage V _{mppt} (V)	33.82	34.02	34.16
Rated Voltage I _{max} (A)	13.01	13.09	13.17

Standard Test Conditions for front-face of panels 1000 W/m², 25°C, measurement uncertainty <3%

Temperature Coefficients

Temperature Coefficients P _{mppt}	-0.35%/°C
Temperature Coefficients I _{sc}	+0.06%/°C
Temperature Coefficients V _{OC}	-0.31%/°C
Nominal Operating Cell Temperature (NOCT)	45°C

Test Operating Conditions

Maximum Series Fuse	25A
Maximum System Voltage	1,500 VDC (UL&IEC)
Maximum Load Capacity (Per UL 1703)	5400 PA Snow Load / 5400 Pa Wind Load
Fire Performance Class	Class C/Type 1

Packaging Configuration

Number of Modules per Pallet	31
Number of Pallets per 40ft. Container	24
Pallet Dimensions	2030 X 1220 X 1200
Pallet Weight (kg)	766
Container Weight (kg)	18,384

Mechanical Properties

Cell Type	Monocrystalline
Glass	3.2mm, anti-reflection coating, high transmission, low iron, tempered glass
Frame	Anodized Aluminum Alloy
Junction Box	IP68
Dimensions	1903 X 1134 X 35 mm
Output Cable	4mm ² (EU) 12AWG, 39.37in. (1200mm)
Weight	52.9lbs (24kg)
Cable Length	1200mm
Encapsulant	POE

I-V Curve

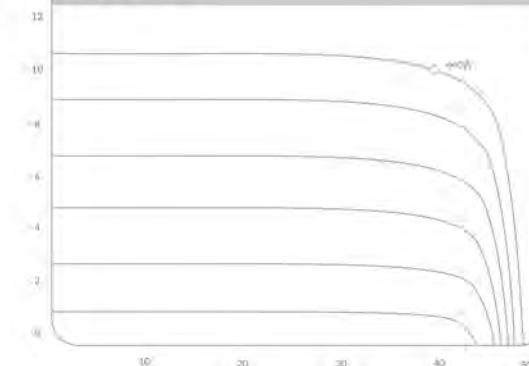

Certifications



UL61730-1, UL61730-2



LGCY POWER
3333 DIGITAL DR#600, LEHI,
UT 84043, UNITED STATES
PHONE: (855) 353-4899

Lee Hoke

Electrical LIC#: U34871

SYSTEM INFO

(25) APTOS DNA-120-MF10-440W
(25) ENPHASE IQ8PLUS -72-2-US (240V)
DC SYSTEM SIZE: 11.00 kWDC
AC SYSTEM SIZE: 7.25 kWAC

REVISIONS

DESCRIPTION	DATE	REV

Signature with Seal

PROJECT NAME & ADDRESS

KENNETH LOKER
RESIDENCE
200 CASTLEBAY DR,
SANFORD, NC 27332, USA
PHONE NO. (808) 294-6446
EMAIL ID: lokerkr@yahoo.com

DATE: 6/10/2022

SHEET NAME
EQUIPMENT
SPECIFICATION

SHEET SIZE

ANSI B
11" X 17"

SHEET NUMBER

PV-10

Aptos Solar Technology reserves the right to make specification changes without notice





IQ8 and IQ8+ Microinverters

Our newest IQ8 Microinverters are the industry's first microgrid-forming, software-defined microinverters with split-phase power conversion capability to convert DC power to AC power efficiently. The brain of the semiconductor-based microinverter is our proprietary application-specific integrated circuit (ASIC) which enables the microinverter to operate in grid-tied or off-grid modes. This chip is built in advanced 55nm technology with high speed digital logic and has super-fast response times to changing loads and grid events, alleviating constraints on battery sizing for home energy systems.



Part of the Enphase Energy System, IQ8 Series Microinverters integrate with the Enphase IQ Battery, Enphase IQ Gateway, and the Enphase App monitoring and analysis software.



IQ8 Series Microinverters redefine reliability standards with more than one million cumulative hours of power-on testing, enabling an industry-leading limited warranty of up to 25 years.



Connect PV modules quickly and easily to IQ8 Series Microinverters using the included Q-DCC-2 adapter cable with plug-n-play MC4 connectors.



IQ8 Series Microinverters are UL Listed as PV Rapid Shut Down Equipment and conform with various regulations, when installed according to manufacturer's instructions.

© 2021 Enphase Energy. All rights reserved. Enphase, the Enphase logo, IQ8 microinverters, and other names are trademarks of Enphase Energy, Inc. Data subject to change.

IQ8SP-DS-0002-01-EN-US-2021-10-19

Easy to install

- Lightweight and compact with plug-n-play connectors
- Power Line Communication (PLC) between components
- Faster installation with simple two-wire cabling

High productivity and reliability

- Produce power even when the grid is down
- More than one million cumulative hours of testing
- Class II double-insulated enclosure
- Optimized for the latest high-powered PV modules

Microgrid-forming

- Complies with the latest advanced grid support
- Remote automatic updates for the latest grid requirements
- Configurable to support a wide range of grid profiles
- Meets CA Rule 21 (UL 1741-SA) requirements

IQ8 and IQ8+ Microinverters

INPUT DATA (DC)		IQ8-60-2-US	IQ8PLUS-72-2-US
Commonly used module pairings ¹	W	235 – 350	235 – 440
Module compatibility		60-cell/120 half-cell	60-cell/120 half-cell and 72-cell/144 half-cell
MPPT voltage range	V	27 – 37	29 – 45
Operating range	V	25 – 48	25 – 58
Min/max start voltage	V	30 / 48	30 / 58
Max input DC voltage	V	50	60
Max DC current ² [module Isc]	A		15
Overvoltage class DC port			II
DC port backfeed current	mA		0
PV array configuration		1x1 Ungrounded array; No additional DC side protection required; AC side protection requires max 20A per branch circuit	
OUTPUT DATA (AC)		IQ8-60-2-US	IQ8PLUS-72-2-US
Peak output power	VA	245	300
Max continuous output power	VA	240	290
Nominal (L-L) voltage/range ³	V		240 / 211 – 264
Max continuous output current	A	1.0	1.21
Nominal frequency	Hz		60
Extended frequency range	Hz		50 – 68
Max units per 20 A (L-L) branch circuit ⁴		16	13
Total harmonic distortion			<5%
Overvoltage class AC port			III
AC port backfeed current	mA		30
Power factor setting			1.0
Grid-tied power factor (adjustable)			0.85 leading – 0.85 lagging
Peak efficiency	%	97.5	97.6
CEC weighted efficiency	%	97	97
Night-time power consumption	mW		60
MECHANICAL DATA			
Ambient temperature range		-40°C to +60°C (-40°F to +140°F)	
Relative humidity range		4% to 100% (condensing)	
DC Connector type		MC4	
Dimensions (HxWxD)		212 mm (8.3") x 175 mm (6.9") x 30.2 mm (1.2")	
Weight		1.08 kg (2.38 lbs)	
Cooling		Natural convection – no fans	
Approved for wet locations		Yes	
Acoustic noise at 1 m		<60 dBA	
Pollution degree		PD3	
Enclosure		Class II double-insulated, corrosion resistant polymeric enclosure	
Environ. category / UV exposure rating		NEMA Type 6 / outdoor	
COMPLIANCE			
Certifications		CA Rule 21 (UL 1741-SA), UL 62109-1, UL1741/IEE1547, FCC Part 15 Class B, ICES-0003 Class B, CAN/CSA-C22.2 NO. 107.1-01	
		This product is UL Listed as PV Rapid Shut Down Equipment and conforms with NEC 2014, NEC 2017, and NEC 2020 section 690.12 and C22.1-2018 Rule 64-218 Rapid Shutdown of PV Systems, for AC and DC conductors, when installed according to manufacturer's instructions.	

(1) No enforced DC/AC ratio. See the compatibility calculator at <https://link.enphase.com/module-compatibility> (2) Maximum continuous input DC current is 10.6A (3) Nominal voltage range can be extended beyond nominal if required by the utility. (4) Limits may vary. Refer to local requirements to define the number of microinverters per branch in your area.

IQ8SP-DS-0002-01-EN-US-2021-10-19

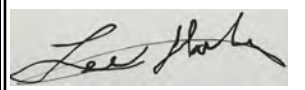

Electrical LIC#: U34871

SYSTEM INFO		
(25) APTOS	DNA-120-MF10-440W	
(25) ENPHASE	IQ8PLUS-72-2-US (240V)	
DC SYSTEM SIZE:	11.00 kWDC	
AC SYSTEM SIZE:	7.25 kWAC	

REVISIONS		
DESCRIPTION	DATE	REV

Signature with Seal

PROJECT NAME & ADDRESS

KENNETH LOKER
RESIDENCE
200 CASTLEBAY DR,
SANFORD, NC 27332, USA
PHONE NO. (808) 294-6446
EMAIL ID: lokerkr@yahoo.com

DATE: 6/10/2022

SHEET NAME
EQUIPMENT
SPECIFICATION

SHEET SIZE

ANSI B
11" X 17"

SHEET NUMBER

PV-11

Enphase IQ Combiner 4/4C

X-IQ-AM1-240-4
X-IQ-AM1-240-4C



X-IQ-AM1-240-4C

X-IQ-AM1-240-4



To learn more about Enphase offerings, visit enphase.com

The **Enphase IQ Combiner 4/4C** with Enphase IQ Gateway and integrated LTE-M1 cell modem (included only with IQ Combiner 4C) consolidates interconnection equipment into a single enclosure and streamlines IQ microinverters and storage installations by providing a consistent, pre-wired solution for residential applications. It offers up to four 2-pole input circuits and Eaton BR series busbar assembly.

Smart

- Includes IQ Gateway for communication and control
- Includes Enphase Mobile Connect cellular modem (CELLMODEM-M1-06-SP-05), included only with IQ Combiner 4C
- Includes solar shield to match Enphase IQ Battery aesthetics and deflect heat
- Flexible networking supports Wi-Fi, Ethernet, or cellular
- Optional AC receptacle available for PLC bridge
- Provides production metering and consumption monitoring

Simple

- Centered mounting brackets support single stud mounting
- Supports bottom, back and side conduit entry
- Up to four 2-pole branch circuits for 240 VAC plug-in breakers (not included)
- 80A total PV or storage branch circuits

Reliable

- Durable NRTL-certified NEMA type 3R enclosure
- Five-year limited warranty
- Two years labor reimbursement program coverage included for both the IQ Combiner SKU's
- UL listed



Enphase IQ Combiner 4/4C

MODEL NUMBER

IQ Combiner 4 (X-IQ-AM1-240-4)

IQ Combiner 4 with Enphase IQ Gateway printed circuit board for integrated revenue grade PV production metering (ANSI C12.20 +/- 0.5%) and consumption monitoring (+/- 2.5%). Includes a silver solar shield to match the IQ Battery system and IQ System Controller 2 and to deflect heat.

IQ Combiner 4C (X-IQ-AM1-240-4C)

IQ Combiner 4C with Enphase IQ Gateway printed circuit board for integrated revenue grade PV production metering (ANSI C12.20 +/- 0.5%) and consumption monitoring (+/- 2.5%). Includes Enphase Mobile Connect cellular modem (CELLMODEM-M1-06-SP-05), a plug-and-play industrial-grade cell modem for systems up to 60 microinverters. (Available in the US, Canada, Mexico, Puerto Rico, and the US Virgin Islands, where there is adequate cellular service in the installation area.) Includes a silver solar shield to match the IQ Battery and IQ System Controller and to deflect heat.

ACCESSORIES AND REPLACEMENT PARTS (not included, order separately)

Ensemble Communications Kit	- Includes COMMS-KIT-01 and CELLMODEM-M1-06-SP-05 with 5-year Sprint data plan for Ensemble sites
COMMS-CELLMODEM-M1-06	- 4G based LTE-M1 cellular modem with 5-year Sprint data plan
CELLMODEM-M1-06-SP-05	- 4G based LTE-M1 cellular modem with 5-year AT&T data plan
CELLMODEM-M1-06-AT-05	
Circuit Breakers	Supports Eaton BR210, BR215, BR220, BR230, BR240, BR250, and BR260 circuit breakers.
BRK-10A-2-240V	Circuit breaker, 2 pole, 10A, Eaton BR210
BRK-15A-2-240V	Circuit breaker, 2 pole, 15A, Eaton BR215
BRK-20A-2P-240V	Circuit breaker, 2 pole, 20A, Eaton BR220
BRK-15A-2P-240V-B	Circuit breaker, 2 pole, 15A, Eaton BR215B with hold down kit support
BRK-20A-2P-240V-B	Circuit breaker, 2 pole, 20A, Eaton BR220B with hold down kit support
EPLC-01	Power line carrier (communication bridge pair), quantity - one pair
XA-SOLARSHIELD-ES	Replacement solar shield for IQ Combiner 4/4C
XA-PLUG-120-3	Accessory receptacle for Power Line Carrier in IQ Combiner 4/4C (required for EPLC-01)
XA-ENV-PCBA-3	Replacement IQ Gateway printed circuit board (PCB) for Combiner 4/4C
X-IQ-NA-HD-125A	Hold down kit for Eaton circuit breaker with screws

ELECTRICAL SPECIFICATIONS

Rating	Continuous duty
System voltage	120/240 VAC, 60 Hz
Eaton BR series busbar rating	125 A
Max. continuous current rating	65 A
Max. continuous current rating (input from PV/storage)	64 A
Max. fuse/circuit rating (output)	90 A
Branch circuits (solar and/or storage)	Up to four 2-pole Eaton BR series Distributed Generation (DG) breakers only (not included)
Max. total branch circuit breaker rating (input)	80A of distributed generation / 95A with IQ Gateway breaker included
Production metering CT	200 A solid core pre-installed and wired to IQ Gateway
Consumption monitoring CT (CT-200-SPLIT)	A pair of 200 A split core current transformers

MECHANICAL DATA

Dimensions (WxHxD)	37.5 x 49.5 x 16.8 cm (14.75" x 19.5" x 6.63"), Height is 21.06" (53.5 cm) with mounting brackets.
Weight	7.5 kg (16.5 lbs)
Ambient temperature range	-40° C to +46° C (-40° to 115° F)
Cooling	Natural convection, plus heat shield
Enclosure environmental rating	Outdoor, NRTL-certified, NEMA type 3R, polycarbonate construction
Wire sizes	- 20 A to 50 A breaker inputs: 14 to 4 AWG copper conductors - 60 A breaker branch input: 4 to 1/0 AWG copper conductors - Main lug combined output: 10 to 2/0 AWG copper conductors - Neutral and ground: 14 to 1/0 copper conductors Always follow local code requirements for conductor sizing.
Altitude	To 2000 meters (6,560 feet)

INTERNET CONNECTION OPTIONS

Integrated Wi-Fi	802.11b/g/n
Cellular	CELLMODEM-M1-06-SP-05, CELLMODEM-M1-06-AT-05 (4G based LTE-M1 cellular modem) Note that an Enphase Mobile Connect cellular modem is required for all Ensemble installations.
Ethernet	Optional, 802.3, Cat5E (or Cat 6) UTP Ethernet cable (not included)

COMPLIANCE

Compliance, IQ Combiner	UL 1741, CAN/CSA C22.2 No. 107.1, 47 CFR, Part 15, Class B, ICES 003 Production metering: ANSI C12.20 accuracy class 0.5 (PV production) Consumption metering: accuracy class 2.5
Compliance, IQ Gateway	UL 60601-1/CANCSA 22.2 No. 61010-1

To learn more about Enphase offerings, visit enphase.com

© 2021 Enphase Energy. All rights reserved. Enphase, the Enphase logo, IQ Combiner 4/4C, and other names are trademarks of Enphase Energy, Inc. Data subject to change. 10-21-2021



Lee Hoke
Electrical LIC#: U34871

SYSTEM INFO

(25) APTOS DNA-120-MF10-440W
(25) ENPHASE IQ8PLUS -72-2-US (240V)
DC SYSTEM SIZE: 11.00 kWDC
AC SYSTEM SIZE: 7.25 kWAC

REVISIONS

DESCRIPTION	DATE	REV

Signature with Seal

PROJECT NAME & ADDRESS

KENNETH LOKER
RESIDENCE
200 CASTLEBAY DR,
SANFORD, NC 27332, USA
PHONE NO. (808) 294-6446
EMAIL ID: lokerkr@yahoo.com

DATE: 6/10/2022

SHEET NAME
**EQUIPMENT
SPECIFICATION**

SHEET SIZE

ANSI B
11" X 17"

SHEET NUMBER

PV-12

FLASHLOC™ DUO

THE MOST VERSATILE DIRECT TO DECK ATTACHMENT



FLASHLOC™ DUO is the most versatile direct to deck and rafter attachment for composition shingle and rolled comp roofs. The all-in-one mount installs fast — no kneeling on hot roofs to install flashing, no prying or cutting shingles, no pulling nails. Simply drive the required number of screws to secure the mount and inject sealant into the base. **FLASHLOC's** patented **TRIPLE SEAL** technology preserves the roof and protects the penetration with a permanent pressure seal. Kitted with two rafter screws, sealant and hardware for maximum convenience (deck screws sold separately). Don't just divert water, **LOC it out!**



PROTECT THE ROOF

Install a high-strength waterproof attachment without lifting, prying or damaging shingles.

APRIL2021_FLASHLOC2DUO_V1

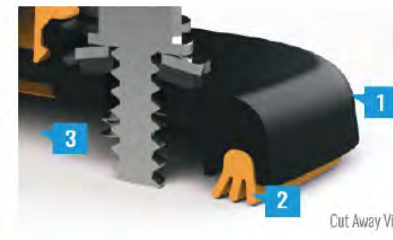

LOC OUT WATER

With an outer shield **1** contour-conforming gasket **2** and pressurized sealant chamber **3** the Triple Seal technology delivers a 100% waterproof connection.



HIGH-SPEED INSTALL

Simply drive the required number of screws and inject sealant into the port **4** to create a permanent pressure seal.

FLASHLOC™ DUO

INSTALLATION GUIDE



PRE-INSTALL: CLEAN SURFACE AND MARK LOCATION

Ensure existing roof structure is capable of supporting loads prescribed in Flashloc Duo D&E Guide. Clean roof surface of dirt, debris, snow and ice.

Snap chalk lines for attachment rows. On shingle roofs, snap lines 1/4" below upslope edge of shingle course. This line will be used to align the upper edge of the mount.

NOTE: Space mounts per span charts found in Flashloc Duo D&E Guide.

STEP ONE: SECURE



ATTACHING TO A RAFTER: Place FLASHLOC DUO over rafter location and align upper edge of mount with horizontal chalk line. Secure mount with the two (2) provided rafter screws. **BACKFILL ALL PILOT HOLES WITH SEALANT.**



ATTACHING TO SHEATHING: Place FLASHLOC DUO over desired location and align upper edge of mount with horizontal chalk line. Secure mount with the two (2) provided rafter screws. Next, secure mount with four (4) deck screws by drilling through the FLASHLOC DUO deck mount hole locations. Unirac recommends using a drill as opposed to an impact gun to prevent over-tightening or stripping roof sheathing.

IMPORTANT: SECURELY ATTACH MOUNT BUT DO NOT OVERTIGHTEN SCREWS.

STEP TWO: SEAL

Insert tip of UNIRAC approved sealant into port and inject until sealant exits vent. Continue array installation, attaching rails to mounts with provided T-bolts.

NOTE: When FLASHLOC DUO is installed over gap between shingle tabs or vertical joints, fill gap/joint with sealant between mount and upslope edge of shingle course.

CUT SHINGLES AS REQUIRED: DO NOT INSTALL THE FLASHLOC SLIDER ACCROSS THICKNESS VARIATIONS GREATER THAN 1/8" SUCH AS THOSE FOUND IN HIGH DEFINITION SHINGLES.

NOTE: When installing included rail attachment hardware, torque T-bolt nut to 30 ft-lbs.

NOTE: If an exploratory hole falls outside of the area covered by the sealant, flash hole accordingly.



USE ONLY UNIRAC APPROVED SEALANTS. PLEASE CONTACT UNIRAC FOR FULL LIST OF COMPATIBLE SEALANTS.



LGCY POWER
3333 DIGITAL DR#600, LEHI,
UT 84043, UNITED STATES
PHONE: (855) 353-4899

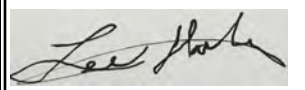

Electrical LIC#: U34871

SYSTEM INFO		
(25) APTOS		
DNA-120-MF10-440W		
(25) ENPHASE		
IQ8PLUS -72-2-US (240V)		
DC SYSTEM SIZE: 11.00 kWDC		
AC SYSTEM SIZE: 7.25 kWAC		

REVISIONS		
DESCRIPTION	DATE	REV

Signature with Seal

PROJECT NAME & ADDRESS

**KENNETH LOKER
RESIDENCE**
200 CASTLEBAY DR,
SANFORD, NC 27332, USA
PHONE NO. (808) 294-6446
EMAIL ID: lokerkr@yahoo.com

DATE: 6/10/2022

SHEET NAME
**EQUIPMENT
SPECIFICATION**

SHEET SIZE

ANSI B
11" X 17"

SHEET NUMBER

PV-13

FASTER INSTALLATION. 25-YEAR WARRANTY.

FOR QUESTIONS OR CUSTOMER SERVICE VISIT UNIRAC.COM OR CALL (505) 248-2702

FASTER INSTALLATION. 25-YEAR WARRANTY.

FOR QUESTIONS OR CUSTOMER SERVICE VISIT UNIRAC.COM OR CALL (505) 248-2702

PART TABLE	
P/N	DESCRIPTION
004275M	FLASHLOC DUO MILL, 20 PACK
004275D	FLASHLOC DUO DARK, 20 PACK

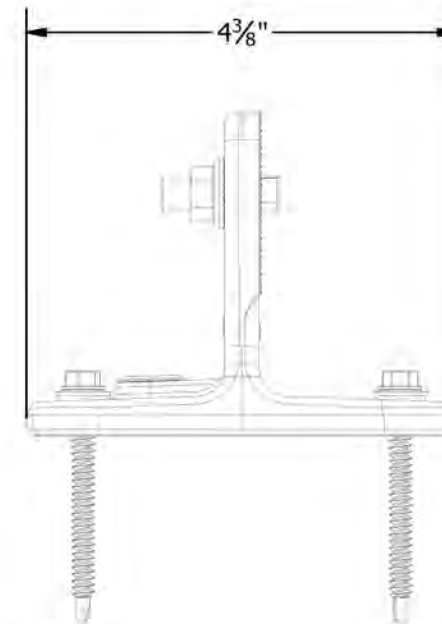
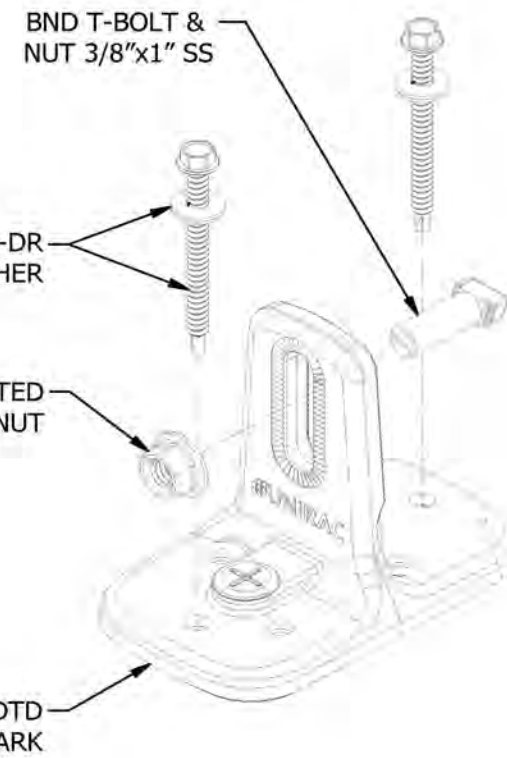
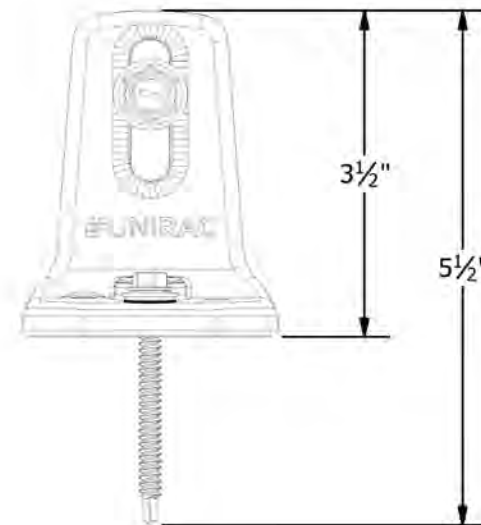

UNIRAC
 1411 BROADWAY BLVD. NE
 ALBUQUERQUE, NM 87102 USA
 PHONE: 505.242.6411
 WWW.UNIRAC.COM

PRODUCT LINE:	SOLARMOUNT
DRAWING TYPE:	ASSEMBLY DETAIL
DESCRIPTION:	FLASHLOC DUO KIT
REVISION DATE:	4/29/2021

DRAWING NOT TO SCALE
 ALL DIMENSIONS ARE
 NOMINAL

PRODUCT PROTECTED BY
 ONE OR MORE US PATENTS
 LEGAL NOTICE

FL-A04

SHEET

Electrical LIC#: U34871

SYSTEM INFO	
(25) APTOS	DNA-120-MF10-440W
(25) ENPHASE	IQ8PLUS -72-2-US (240V)
DC SYSTEM SIZE:	11.00 kWDC
AC SYSTEM SIZE:	7.25 kWAC

REVISIONS		
DESCRIPTION	DATE	REV

Signature with Seal

PROJECT NAME & ADDRESS

KENNETH LOKER
 RESIDENCE
 200 CASTLEBAY DR,
 SANFORD, NC 27332, USA
 PHONE NO. (808) 294-6446
 EMAIL ID: lokerkr@yahoo.com

DATE: 6/10/2022

SHEET NAME
**EQUIPMENT
 SPECIFICATION**

SHEET SIZE

ANSI B
 11" X 17"

SHEET NUMBER

PV-14

SOLARMOUNT



SOLARMOUNT defined the standard in solar racking. Features are designed to get installers off the roof faster. Our grounding & bonding process eliminates copper wire and grounding straps to reduce costs. Systems can be configured with standard or light rail to meet your design requirements at the lowest cost possible. The superior aesthetics package provides a streamlined clean edge for enhanced curb appeal, with no special brackets required for installation.



Now Featuring:
THE NEW FACE OF SOLAR RACKING
Superior Aesthetics Package



LOSE ALL OF THE COPPER & LUGS
System grounding through Enphase microinverters and trunk cables



SMALL IS THE NEXT NEW BIG THING
Light Rail is Fully Compatible with all SM Components



ENHANCED DESIGN & LAYOUT TOOLS
Featuring Google Map Capabilities within U-Builder

FAST INSTALLATION. SUPERIOR AESTHETICS

OPTIMIZED COMPONENTS • VERSATILITY • DESIGN TOOLS • QUALITY PROVIDER

SOLARMOUNT



OPTIMIZED COMPONENTS

INTEGRATED BONDING & PRE-ASSEMBLED PARTS

Components are pre-assembled and optimized to reduce installation steps and save labor time. Our new grounding & bonding process eliminates copper wire and grounding straps or bonding jumpers to reduce costs. Utilize the microinverter mount with a wire management clip for an easier installation.

VERSATILITY

ONE PRODUCT - MANY APPLICATIONS

Quickly set modules flush to the roof or at a desired tilt angle. Change module orientation to portrait or landscape while securing a large variety of framed modules on flat, low slope or steep pitched roofs. Available in mill, clear and dark anodized finishes to outperform your projects financial and aesthetic aspirations.

AUTOMATED DESIGN TOOL DESIGN PLATFORM AT YOUR SERVICE

Creating a bill of materials is just a few clicks away with U-Builder, a powerful online tool that streamlines the process of designing a code compliant solar mounting system. Save time by creating a user profile, and recall preferences and projects automatically when you log in. You will enjoy the ability to share projects with customers: there's no need to print results and send to a distributor, just click and share.



UNIRAC CUSTOMER SERVICE MEANS THE HIGHEST LEVEL OF PRODUCT SUPPORT

- UNMATCHED EXPERIENCE
- CERTIFIED QUALITY
- ENGINEERING EXCELLENCE
- BANKABLE WARRANTY
- DESIGN TOOLS
- PERMIT DOCUMENTATION

TECHNICAL SUPPORT

Unirac's technical support team is dedicated to answering questions & addressing issues in real time. An online library of documents including engineering reports, stamped letters and technical data sheets greatly simplifies your permitting and project planning process.

CERTIFIED QUALITY PROVIDER

Unirac is the only PV mounting vendor with ISO certifications for 9001:2015, 14001:2015 and OHSAS 18001:2007, which means we deliver the highest standards for fit, form, and function. These certifications demonstrate our excellence and commitment to first class business practices.

BANKABLE WARRANTY

Don't leave your project to chance. Unirac has the financial strength to back our products and reduce your risk. Have peace of mind knowing you are receiving products of exceptional quality. SOLARMOUNT is covered by a twenty five (25) year limited product warranty and a five (5) year limited finish warranty.

PROTECT YOUR REPUTATION WITH QUALITY RACKING SOLUTIONS BACKED BY ENGINEERING EXCELLENCE AND A SUPERIOR SUPPLY CHAIN

14002171E28 - PRINTED

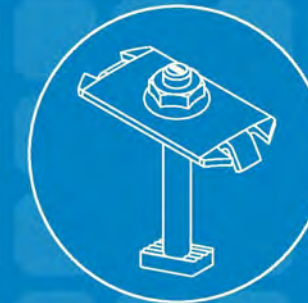

INTEGRATED BONDING MIDCLAMP



INTEGRATED BONDING SPLICE BAR



INTEGRATED BONDING L-FOOT w/ T-BOLT



INTEGRATED BONDING MICROINVERTER MOUNT w/ WIRE MANAGEMENT



LGCY POWER

3333 DIGITAL DR#600, LEHI, UT 84043, UNITED STATES
PHONE: (855) 353-4899

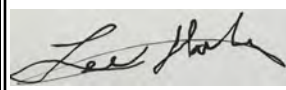

Electrical LIC#: U34871

SYSTEM INFO		
(25) APTOS	DNA-120-MF10-440W	
(25) ENPHASE	IQ8PLUS -72-2-US (240V)	
DC SYSTEM SIZE:	11.00 kWDC	
AC SYSTEM SIZE:	7.25 kWAC	

REVISIONS		
DESCRIPTION	DATE	REV

Signature with Seal

PROJECT NAME & ADDRESS

KENNETH LOKER
RESIDENCE
200 CASTLEBAY DR,
SANFORD, NC 27332, USA
PHONE NO. (808) 294-6446
EMAIL ID: lokerkr@yahoo.com

DATE: 6/10/2022

SHEET NAME
EQUIPMENT SPECIFICATION

SHEET SIZE

ANSI B
11" X 17"

SHEET NUMBER

PV-15

SOLARMOUNT



SOLARMOUNT is the professionals' choice for residential PV mounting applications. Every aspect of the system is designed for an easier, faster installation experience. **SOLARMOUNT** is a complete solution with revolutionary universal clamps, **FLASHKIT PRO**, full system UL 2703 certification and 25-year warranty. Not only is **SOLARMOUNT** easy to install, but best-in-class aesthetics make it the most attractive on any block!



New & Improved:
THE PROFESSIONALS' CHOICE
With Superior Aesthetics



NOW FEATURING FLASHKIT PRO
The Complete Roof Attachment Solution.
FEATURING SHED & SEAL TECHNOLOGY



NOW WITH UNIVERSAL MIDCLAMPS
Accommodates 30mm-51mm module frames
One tool, one-person installs are here!



REVOLUTIONARY NEW ENDCLAMPS
Concealed design and included End Caps

THE PROFESSIONALS' CHOICE FOR RESIDENTIAL RACKING

BEST INSTALLATION EXPERIENCE • CURB APPEAL • COMPLETE SOLUTION • UNIRAC SUPPORT

FOR QUESTIONS OR CUSTOMER SERVICE VISIT UNIRAC.COM OR CALL (505) 248-2702

SOLARMOUNT



BETTER DESIGNS

TRUST THE INDUSTRY'S BEST DESIGN TOOL

Start the design process for every project in our U-Builder on-line design tool. It's a great way to save time and money.

BETTER SYSTEMS

ONE SYSTEM - MANY APPLICATIONS

Quickly set modules flush to the roof on steep pitched roofs. Orient a large variety of modules in Portrait or Landscape. Tilt the system up on flat or low slo roofs. Components available in mill, clear, and dark finishes to optimize your design financials and aesthetics.

BETTER RESULTS

MAXIMIZE PROFITABILITY ON EVERY JOB

Trust Unirac to help you minimize both system and labor costs from the time the job is quoted to the time your teams get off the roof. Faster installs. Less Waste. More Profits.

BETTER SUPPORT

WORK WITH THE INDUSTRIES MOST EXPERIENCED TEAM

Professional support for professional installers and designers. You have access to our technical support and training groups. Whatever your support needs, we've got you covered. Visit Unirac.com/solarmount for more information.



UNIRAC CUSTOMER SERVICE MEANS THE HIGHEST LEVEL OF PRODUCT SUPPORT

UNMATCHED EXPERIENCE	CERTIFIED QUALITY	ENGINEERING EXCELLENCE	BANKABLE WARRANTY	DESIGN TOOLS	PERMIT DOCUMENTATION
----------------------	-------------------	------------------------	-------------------	--------------	----------------------

TECHNICAL SUPPORT

Unirac's technical support team is dedicated to answering questions & addressing issues in real time. An online library of documents including engineering reports, stamped letters and technical data sheets greatly simplifies your permitting and project planning process.

CERTIFIED QUALITY PROVIDER

Unirac is the only PV mounting vendor with ISO certifications for 9001:2008, 14001:2004 and OHSAS 18001:2007, which means we deliver the highest standards for fit, form, and function. These certifications demonstrate our excellence and commitment to first class business practices.

BANKABLE WARRANTY

Don't leave your project to chance. Unirac has the financial strength to back our products and reduce your risk. Have peace of mind knowing you are providing products of exceptional quality. SOLARMOUNT is covered by a 25 year limited product warranty and a 5 year limited finish warranty.

ENHANCE YOUR REPUTATION WITH QUALITY RACKING SOLUTIONS BACKED BY ENGINEERING EXCELLENCE AND A SUPERIOR SUPPLY CHAIN
FOR QUESTIONS OR CUSTOMER SERVICE VISIT UNIRAC.COM OR CALL (505) 248-2702

CONCEALED UNIVERSAL ENDCLAMPS

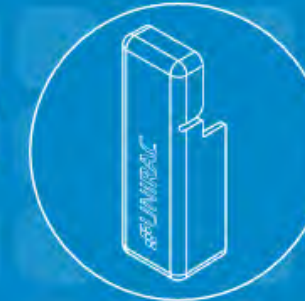
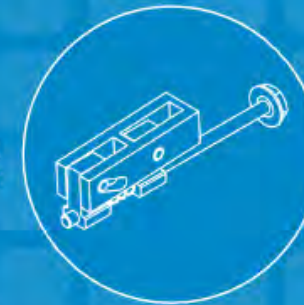

UNIVERSAL SELF STANDING MIDCLAMPS



END CAPS INCLUDED WITH EVERY ENDCLAMP



U-BUILDER ONLINE DESIGN TOOL SAVES TIME & MONEY
Visit design.unirac.com



LGCY POWER
3333 DIGITAL DR#600, LEHI,
UT 84043, UNITED STATES
PHONE: (855) 353-4899

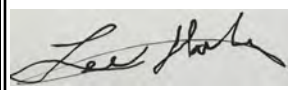

Electrical LIC#: U34871

SYSTEM INFO		
(25) APTOS	DNA-120-MF10-440W	
(25) ENPHASE	IQ8PLUS -72-2-US (240V)	
DC SYSTEM SIZE:	11.00 kWDC	
AC SYSTEM SIZE:	7.25 kWAC	

REVISIONS		
DESCRIPTION	DATE	REV

Signature with Seal

PROJECT NAME & ADDRESS

KENNETH LOKER
RESIDENCE
200 CASTLEBAY DR,
SANFORD, NC 27332, USA
PHONE NO. (808) 294-6446
EMAIL ID: lokerkr@yahoo.com

DATE: 6/10/2022

SHEET NAME
EQUIPMENT SPECIFICATION

SHEET SIZE

ANSI B
11" X 17"

SHEET NUMBER

PV-16

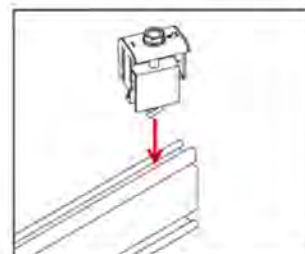

1. Position clamp to align T-bolt with rail slot. Lower clamp and insert T-bolt into rail slot.

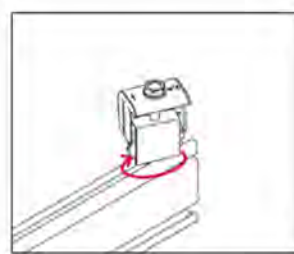

2. Rotate clamp clockwise 2/3 of a turn to engage T-bolt inside rail slot.

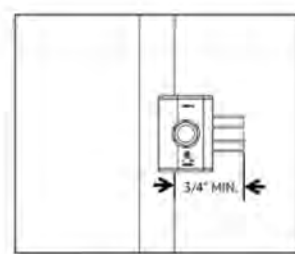

3. Place module at least 3/4" from end of rail and position clamp against module frame.

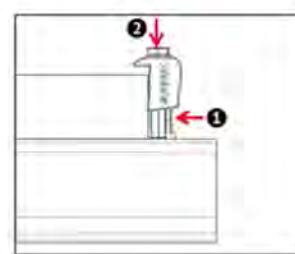

4. While applying pressure to hold the rail and position clamp against the module, push down on the module side of the clamp cap.

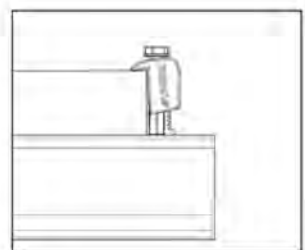

5. When the cap contacts the module frame, release and it will re-engage to the clamp base.

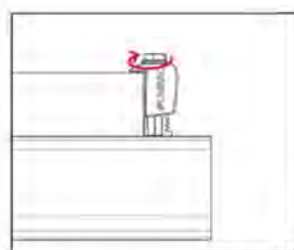

6. Tighten bolt and torque to 15 ft-lbs.

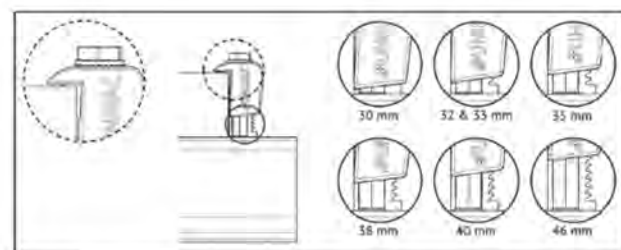

7. Confirm clamp is engaged in correct module height position and that the top of the cap is sitting level with the module frame.

NOTE: When installing 46mm modules, loosen bolt by 1 turn before positioning clamp against module frame. Do not force clamp onto module frame as this may damage the bonding pin.

SYSTEM LEVEL FIRE CLASSIFICATION

The system fire class rating requires installation in the manner specified in the SOLARMOUNT Installation Guide. SOLARMOUNT has been classified to the system level fire portion of UL2703. SOLARMOUNT has achieved system level performance for steep sloped roofs. System level fire performance is inherent in the SOLARMOUNT design, and no additional mitigation measures are required. The fire classification rating is only valid on roof pitches greater than 2:12 (slopes \geq 2 inches per foot, or 9.5 degrees). The system is to be mounted over fire resistant roof covering rated for the application. There is no required minimum or maximum height limitation above the roof deck to maintain the system fire rating for SOLARMOUNT. Module Types & System Level Fire Ratings are listed below:

Rail Type	Module Fire Types	System Level Fire Rating	Rail Direction	Module Orientation	Mitigation Required
Standard Rail	1, 2, 3 w metal frame, 10 w metal frame, 19, 22, 25, 29, & 30	Class A, Class B & Class C	East-West	Landscape OR Portrait	None Required
			North-South	Landscape OR Portrait	None Required
Light Rail	1 & 2	Class A, Class B & Class C	East-West	Landscape OR Portrait	None Required
			North-South	Landscape OR Portrait	None Required

This racking system may be used to ground and/or mount a PV module complying with UL1703 or UL61730 only when the specific module has been evaluated for grounding and/or mounting in compliance with the included instructions.

UL2703 CERTIFICATION MARKING LABEL

Unirac SOLARMOUNT is listed to UL 2703. Certification marking is embossed on all mid clamps as shown. Labels with additional information will be provided. After the racking system is fully assembled, a single label should be applied to the SOLARMOUNT rail at the edge of the array. Before applying the label, the corners of the label that do not pertain to the system being installed must be removed so that only the installed system type is showing.

Note: The sticker label should be placed such that it is visible, but not outward facing.



SM STANDARD RAIL



SM LIGHT RAIL

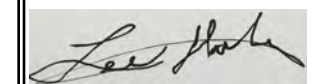

Electrical LIC#: U34871

SYSTEM INFO		
(25) APTOS	DNA-120-MF10-440W	
(25) ENPHASE	IQ8PLUS -72-2-US (240V)	
DC SYSTEM SIZE: 11.00 kWDC		
AC SYSTEM SIZE: 7.25 kWAC		

REVISIONS		
DESCRIPTION	DATE	REV

Signature with Seal

PROJECT NAME & ADDRESS

KENNETH LOKER
RESIDENCE
200 CASTLEBAY DR,
SANFORD, NC 27332, USA
PHONE NO. (808) 294-6446
EMAIL ID: lokerkr@yahoo.com

DATE: 6/10/2022

SHEET NAME
EQUIPMENT
SPECIFICATION

SHEET SIZE

ANSI B
11" X 17"

SHEET NUMBER

PV-17

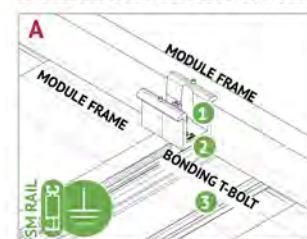

BONDING MIDCLAMP ASSEMBLY

- 1 Aluminum mid clamp with stainless steel bonding pins that pierce module frame anodization to bond module to module through clamp
- 2 Stainless steel nut bonds aluminum clamp to stainless steel T-bolt
- 3 Serrated T-bolt head penetrates rail anodization to bond T-bolt, nut, clamp, and modules to SM rail



BONDING MIDCLAMP ASSEMBLY



BONDING RAIL SPLICE BAR

- 1 Bonding Hardware creates bond between splice bar and each rail section
 - 2 Aluminum splice bar spans across rail gap to create rail to rail bond. Rail on at least one side of splice will be grounded.
- Note: Splice bar and bolted connection are non-structural. The splice bar function is rail alignment and bonding.*



RAIL TO L-FOOT w/BONDING T-BOLT

- 1 Serrated flange nut removes L-foot anodization to bond L-Foot to stainless steel T-bolt
- 2 Serrated T-bolt head penetrates rail anodization to bond T-bolt, nut, and L-foot to grounded SM rail

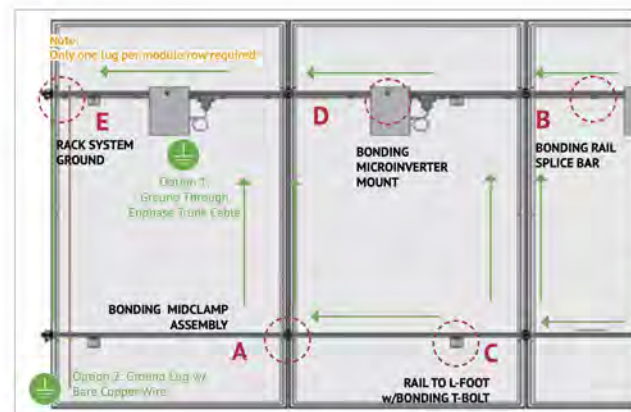

BONDING MICROINVERTER MOUNT

- 1 Hex nut with captive lock washer bonds metal microinverter flange to stainless steel T-bolt
- 2 Serrated T-bolt head penetrates rail anodization to bond T-bolt, nut, and L-foot to grounded SM rail. System grounds including racking and modules may be achieved through the trunk cable of approved microinverter systems. See page 1 for details.



RACK SYSTEM GROUND

- 1 WEEB washer dimples pierce anodized rail to create bond between rail and lug
 - 2 Solid copper wire connected to lug is routed to provide final system ground connection.
- NOTE: Loop lug can also be used when connected to the side of the rail. See page 1 for details.*

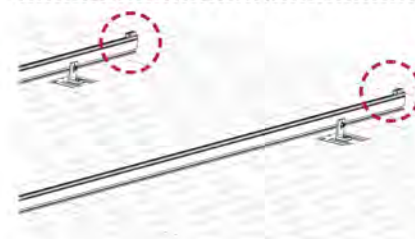

INSTALL MODULE END CLAMPS: The End clamp is supplied as an assembly with a 1/2" hex head bolt that is accessible at the ends of rails. The clamp should be installed on the rails prior to installing end modules.

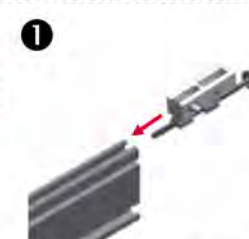

INSTALL END CLAMPS ON RAIL: Slide end clamp on to rail by engaging the two T-guide brackets with the top slot of the rails. **Ensure bolt is extended as far as possible so that clamp is positioned at max. distance from end of rail.**



POSITION END CLAMPS: Slide end clamp assembly on to rail until bolt head engages with end of rail. **End clamps are positioned on rails prior to the first end module and prior to the last end module.**

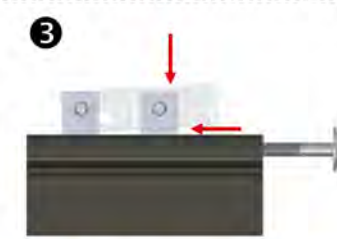

NOTE: To assist insertion of clamp into rail slot, Pressure may be applied to top or side of bracket as shown. Do not force clamp into rail by pushing on bolt with excessive force.

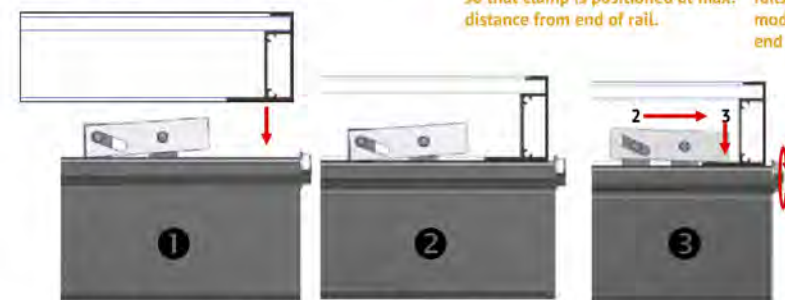

INSTALL FIRST MODULE: Install the first end module onto rails with the flange of the module frame positioned between end clamps at ends of rails.

ENGAGE CLAMP: While holding module in position and with flange in full contact with rail, rotate end clamp bolt until clamp engages with flange to provide clamp force. **To ensure bolt is not over-torqued, use low torque setting on drill or if using an impact driver, stop rotation as soon as impact action of driver begins. TORQUE VALUE (See table and notes on PG. A) End clamp bolt to 5 ft-lbs, No anti-seize.**

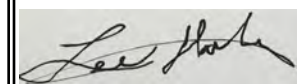
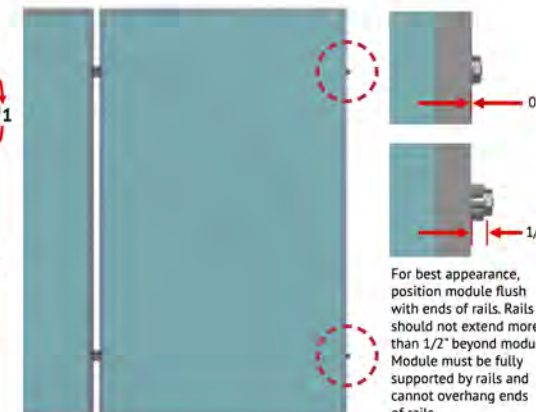

Electrical LIC#: U34871

SYSTEM INFO		
(25) APTOS	DNA-120-MF10-440W	
(25) ENPHASE	IQ8PLUS -72-2-US (240V)	
DC SYSTEM SIZE:	11.00 kWDC	
AC SYSTEM SIZE:	7.25 kWAC	

REVISIONS		
DESCRIPTION	DATE	REV

Signature with Seal

PROJECT NAME & ADDRESS

KENNETH LOKER
RESIDENCE
200 CASTLEBAY DR,
SANFORD, NC 27332, USA
PHONE NO. (808) 294-6446
EMAIL ID: lokerkr@yahoo.com

DATE: 6/10/2022

SHEET NAME
EQUIPMENT
SPECIFICATION

SHEET SIZE

ANSI B
11" X 17"

SHEET NUMBER

PV-18

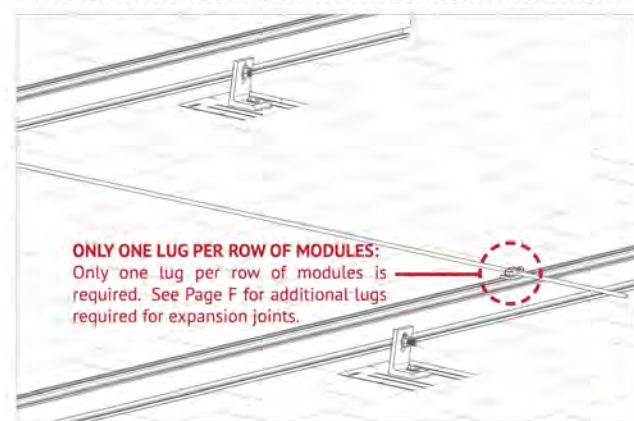

WEEBLUG CONDUCTOR - UNIRAC P/N 008002S:
Apply Anti Seize and insert a bolt in the aluminum rail and through the clearance hole in the stainless steel flat washer. Place the stainless steel flat washer on the bolt, oriented so the dimples will contact the aluminum rail. Place the lug portion on the bolt and stainless steel flat washer. Install stainless steel flat washer, lock washer and nut. Tighten the nut until the dimples are completely embedded into the rail and lug.
TORQUE VALUE 10 ft lbs. (See Note on PG. A)
See product data sheet for more details, Model No. WEEB-LUG-6.7

GROUNDING LUG MOUNTING DETAILS:

Details are provided for both the WEEB and IlSCO products. The WEEBLug has a grounding symbol located on the lug assembly. The IlSCO lug has a green colored set screw for grounding indication purposes. Installation must be in accordance with NFPA NEC 70, however the electrical designer of record should refer to the latest revision of NEC for actual grounding conductor cable size.

Required If not using approved Integrated grounding microinverters

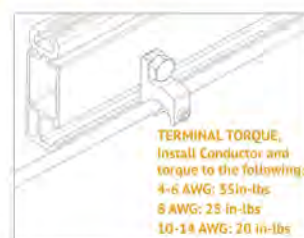

ILSCO LAY-IN LUG CONDUCTOR - UNIRAC P/N 008009P: Alternate Grounding Lug - Drill, deburr hole and bolt thru both rail walls per table.
TORQUE VALUE 5 ft lbs. (See Note on PG. A)
See ILSCO product data sheet for more details, Model No. GBL-4DBT.

NOTE: ISOLATE COPPER FROM ALUMINUM CONTACT TO PREVENT CORROSION

GROUNDING LUG - BOLT SIZE & DRILL SIZE		
GROUND LUG	BOLT SIZE	DRILL SIZE
WEEBLug	1/4"	N/A - Place in Top SM Rail Slot
ILSCO Lug	#10-32	7/32"

- Torque value depends on conductor size.
- See product data sheet for torque value.

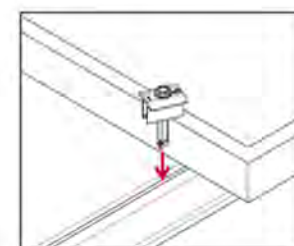

1. Position clamp to align T-bolt with rail slot. Lower clamp and insert T-bolt into rail slot.

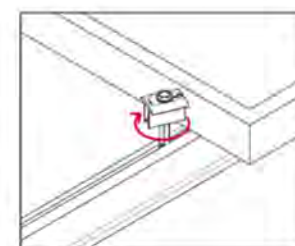

2. Rotate clamp clockwise 2/3 of a turn to engage T-bolt inside rail slot.

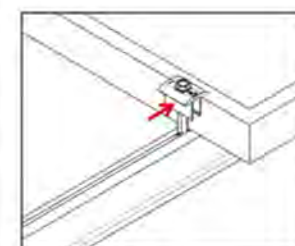

3. Slide clamp into position against module.

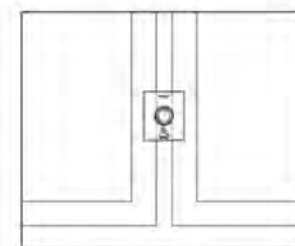

4. Place second module.

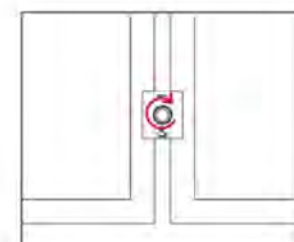

5. Tighten bolt and torque to 15 ft-lbs.

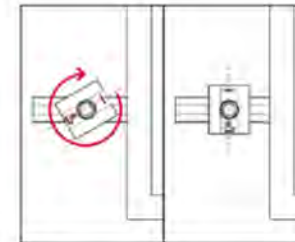

NOTE: If excessive force is applied in step 2, the cap may over-rotate causing it to be mis-aligned with the module frame. If this occurs, keep rotating the cap clockwise until it returns to the original position.

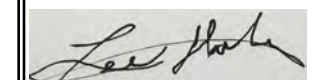

Electrical LIC#: U34871

SYSTEM INFO		
(25) APTOS	DNA-120-MF10-440W	
(25) ENPHASE	IQ8PLUS -72-2-US (240V)	
DC SYSTEM SIZE: 11.00 kWDC		
AC SYSTEM SIZE: 7.25 kWAC		

REVISIONS		
DESCRIPTION	DATE	REV

Signature with Seal

PROJECT NAME & ADDRESS

**KENNETH LOKER
RESIDENCE
200 CASTLEBAY DR,
SANFORD, NC 27332, USA
PHONE NO. (808) 294-6446
EMAIL ID: lokerkr@yahoo.com**

DATE: 6/10/2022

SHEET NAME
**EQUIPMENT
SPECIFICATION**

SHEET SIZE
**ANSI B
11" X 17"**

SHEET NUMBER
PV-19



October 3, 2019

UniRac
 1411 Broadway Boulevard NE
 Albuquerque, New Mexico 87102-1545
 TEL: (505) 242-6411
 FAX: (505) 242-6412

Attn.: Unirac Engineering Department,

Re: Engineering Certification for UniRac's SolarMount Design & Engineering Guide

PZSE, Inc.-Structural Engineers has reviewed UniRac's "SolarMount Design & Engineering Guide" and specifically the enhancements of the SolarMount Flush-to-Roof System, Pressure Lookup Tables, and Downward & Upward Span Length Tables.

This certification excludes connections to building structures and the effects on building structure components. All information, data and analysis contained within the Installation Manual are based on, and comply with the following:

1. 2018 North Carolina Building Code, by The North Carolina State Building Code Council
2. 2009, 2012, 2012, & 2015 International Building Code, by International Code Council, Inc.
3. ASCE/SEI 7-05 & 7-10: Minimum Design Loads for Buildings and other Structures
4. 2010 & 2015 Aluminum Design Manual, by The Aluminum Association, 2015

This letter certifies that the structural calculations contained within UniRac's "SolarMount Design & Engineering Guide" are in compliance with the above Codes.

If you have any questions on the above, do not hesitate to call.

Prepared By:
 PZSE, Inc. – Structural Engineers
 Roseville, CA



LGCY POWER
 3333 DIGITAL DR#600, LEHI,
 UT 84043, UNITED STATES
 PHONE: (855) 353-4899

Lee Hoke

Electrical LIC#: U34871

SYSTEM INFO	
(25) APTOS	DNA-120-MF10-440W
(25) ENPHASE	IQ8PLUS -72-2-US (240V)
DC SYSTEM SIZE: 11.00 kWDC	
AC SYSTEM SIZE: 7.25 kWAC	

REVISIONS		
DESCRIPTION	DATE	REV

Signature with Seal

PROJECT NAME & ADDRESS

KENNETH LOKER
 RESIDENCE
 200 CASTLEBAY DR,
 SANFORD, NC 27332, USA
 PHONE NO. (808) 294-6446
 EMAIL ID: lokerkr@yahoo.com

DATE: 6/10/2022
SHEET NAME EQUIPMENT SPECIFICATION
SHEET SIZE ANSI B 11" X 17"
SHEET NUMBER PV-20