

© 2019 NC SOLAR NOW EXPRESSLY RESERVES ITS COMMON LAW COPYRIGHT AND OTHER PROPERTY RIGHTS IN THESE PLANS. THESE PLANS ARE NOT TO BE REPRODUCED, CHANGED OR COPIED IN ANY FORM OR MANNER WHATSOEVER, NOR ARE THEY TO BE ASSIGNED TO ANY THIRD PARTY WITHOUT FIRST OBTAINING THE EXPRESSED WRITTEN PERMISSION AND CONSENT OF NC SOLAR NOW.

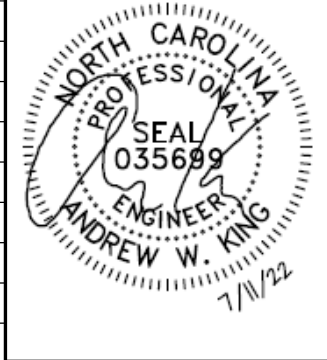

PV MATERIAL SUMMARY: DISTRIBUTOR

REC365NP2	34
IQ7PLUS-72-2-US	34
X-IQ-AM1-240-4	1
Q-12-10-240	41
Q-SEAL-10	7
Q-TERM-10	4
XR-10-168B	10
XR-10-204B	8
XR10-BOSS-01-M1	6
UFO-CL-01-B1	86
UFO-STP-30MM-B1	36
XR-LUG-03-A1	12
4 IN QB1	59
MI-BHW	34
GC66803 Geocel Sealant	4
SOLADECK 0799-5B	2
HEYCO S6468 EDGE SCREEN 8" X 100'	3
HEYCO S6438 EDGE SCREEN CLIPS (10)	22



CLIENT INFO

PAVESIO ALVARO
185 ROBERTS RD
SANFORD, NC 27332

PROJECT INFO

DC INPUT: 12.410 kW
AC EXPORT: 9.860 kW
DOI INSPT. METHOD: OPTION 2

CODE REFERENCES

NATION ELECTRICAL CODE v. 2017
NC FIRE PROTECTION CODE v. 2018
NC BUILDING CODE v. 2018
NC RESIDENTIAL CODE v. 2018
ACSE v. 7-10

SITE CONDITIONS

WIND SPEED: 117 MPH
RISK CATEGORY: II
EXPOSURE: B
SNOW: 10 PSF

SHEET INDEX

PV-1: COVER SHEET
PV-2: PV STRUCTURAL
PV-3: PV ELECTRICAL
PV-4: PV EQUIPMENT LABELS
PV-5: PV INSTALL GUIDE

DESIGNER INFO

DESIGNER MCP
ENGINEER AWK
DATE 7/1/2022
VERSION P1

PV SYSTEM COVER PAGE

PV-1.1



NOTICE TO CONTRACTOR
All construction must comply with current NC Building Codes and all applicable local ordinances and regulations.

APPROVED
Limited building only review
Permit holder responsible for full compliance with the code.

09/07/2022

© 2019 NC SOLAR NOW EXPRESSLY RESERVES ITS COMMON LAW COPYRIGHT AND OTHER PROPERTY RIGHTS IN THESE PLANS. THESE PLANS ARE NOT TO BE REPRODUCED, CHANGED OR COPIED IN ANY FORM OR MANNER WHATSOEVER, NOR ARE THEY TO BE ASSIGNED TO ANY THIRD PARTY WITHOUT FIRST OBTAINING THE EXPRESSED WRITTEN PERMISSION AND CONSENT OF NC SOLAR NOW.

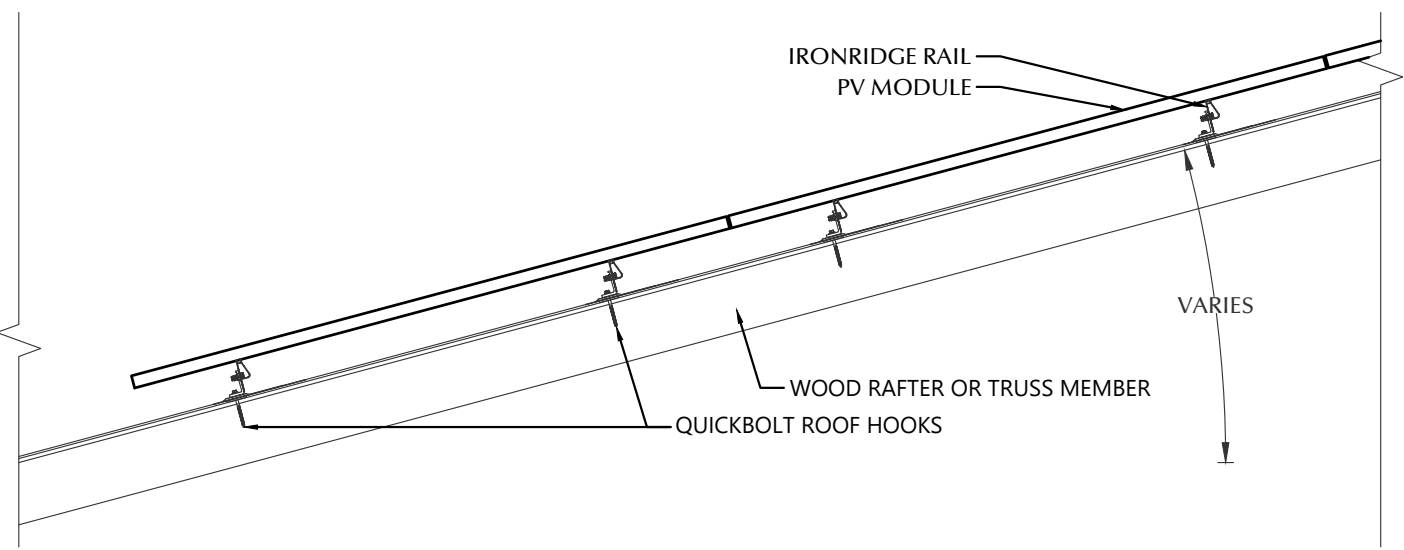

STATEMENT OF STRUCTURAL COMPLIANCE

THE EXISTING ROOF STRUCTURE HAS BEEN DESIGNED TO SUPPORT THE ADDITIONAL LOADS OF THE PROPOSED PV SYSTEM. IN ADDITION, THE RACKING AND FASTENING SYSTEM SHALL BE CAPABLE OF SECURING THE SYSTEM TO THE STRUCTURE UNDER DESIGN CONDITIONS WHEN INSTALLED PROPERLY AND IN ACCORDANCE WITH THE RACKING AND FASTENING ARRANGEMENT DETAILED WITHIN THESE DRAWINGS.

NAME: ANDREW W. KING, PE
 SIGNED:

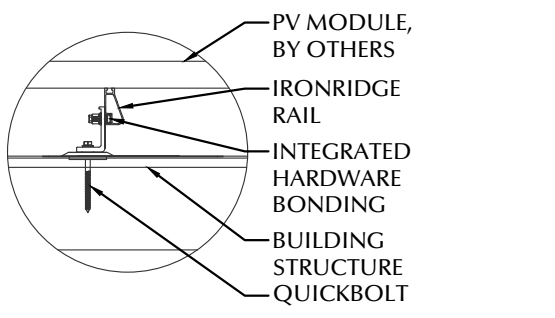
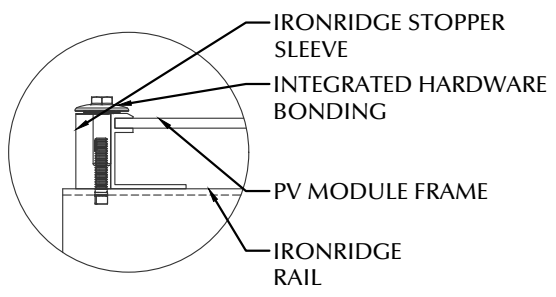
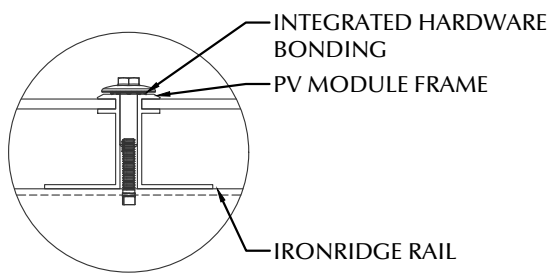
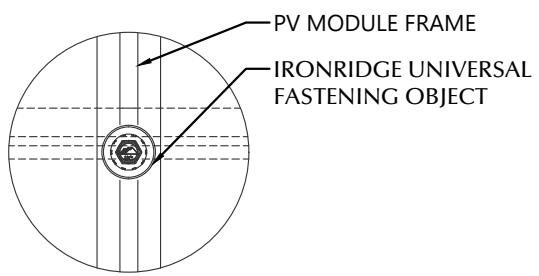
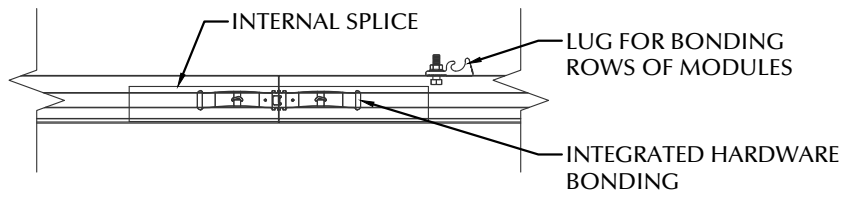

1 ROOF FASTENER DETAIL
NOT TO SCALE

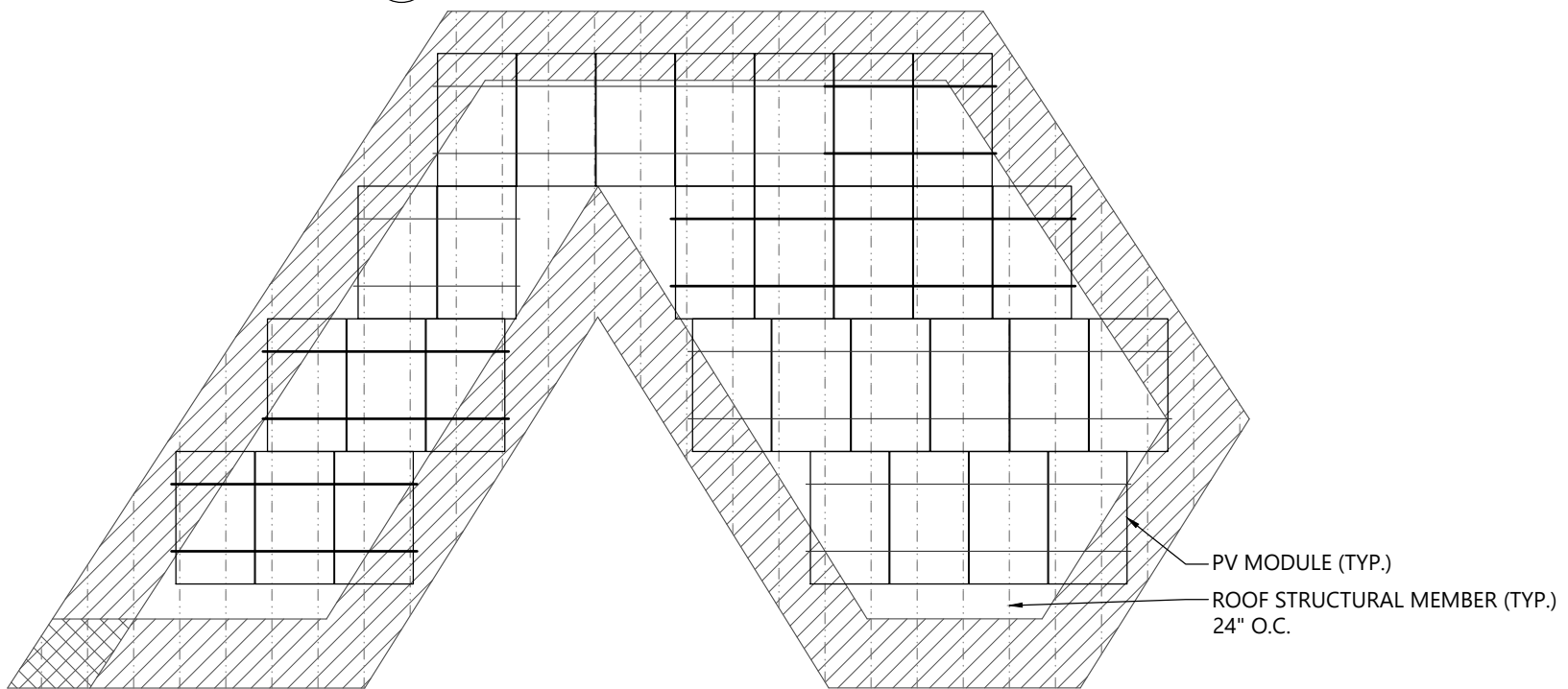

2 ROOF A ARRAY LAYOUT
1/8" = 1'-0"

PV MODULES	
MAKE	REC
MODEL	REC365NP2
WIDTH	40.94 IN
LENGTH	69.10 IN
THICKNESS	30 MM
WEIGHT	44.00 LBS.
ARRAY AREA	589 SQFT.
ARRAY WEIGHT	1473 LBS.

ROOF SUMMARY	
STRUCTURE:	
TYPE	TRUSSES
MATERIAL	SOUTHERN PINE #2
SIZE	2 X 4
SPACING	24 IN O.C.
ALLOWABLE SPAN	88 IN
PITCH	10/12
DENSITY	30 LBS./CU.FT.
DECKING:	
TYPE	OSB
MATERIAL	COMPOSITE
THICKNESS	7/16 IN
WEIGHT	1.60 LBS./SQFT
ROOFING:	
TYPE	ASPHALT SHINGLE
MATERIAL	ASPHALT
WEIGHT	2.30 LBS./SQFT.

ROOF MOUNT SUMMARY		
MAXIMUM (IN)	MOUNT SPACING	RAIL OVERHANG
WIND ZONE 1	72 IN	19 IN
WIND ZONE 2	48 IN	19 IN
WIND ZONE 3	48 IN	19 IN

ROOF LOADING	
GROUND SNOW LOAD:	15 LBS./SQFT.
LIVE LOAD	20 LBS./SQFT.
DEAD LOAD	
ROOFING	3.9 LBS./SQFT.
PV ARRAY	2.5 LBS./SQFT.
TOTAL	6.4 LBS./SQFT.
WIND LOAD:	
UPLIFT ZONE 1	-24.6 LBS./SQFT.
UPLIFT ZONE 2	-29.0 LBS./SQFT.
UPLIFT ZONE 3	-29.0 LBS./SQFT.
DOWNWARD	23.0 LBS./SQFT.
FASTENER LOAD:	
UPLIFT ZONE 1	-422 LBS.
UPLIFT ZONE 2	-332 LBS.
UPLIFT ZONE 3	-332 LBS.
DOWNWARD	395 LBS.

ROOF MOUNT & FASTENER	
ROOF MOUNT:	
MAKE	QUICKBOLT
MODEL	4 IN QB1
MATERIAL	STAINLESS / EPDM
FASTENER:	
MAKE	QUICK SCREWS
MODEL	HANGER BOLT
MATERIAL	304 SS
SIZE	5/16-18 X 5-1/4"
GENERAL:	
WEIGHT	0.56 LBS.
FASTENERS PER MOUNT	1
MAX. PULL-OUT FORCE	960.0 LBS.
SAFETY FACTOR	2
DESIGN PULL-OUT FORCE	480.0 LBS.

MOUNTING RAILS	
MAKE	IRONRIDGE
MODEL	XR10
MATERIAL	ALUMINUM
WEIGHT	0.425 LBS/IN
SPACING	35 IN

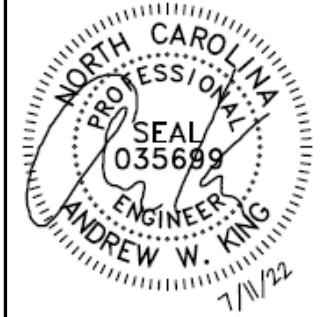

CLIENT INFO

PAVESIO ALVARO
 185 ROBERTS RD
 SANFORD, NC 27332

PROJECT INFO

DC INPUT: 12.410 kW
 AC EXPORT: 9.860 kW
 DOI INSPT. METHOD: OPTION 2

CODE REFERENCES

NATION ELECTRICAL CODE v. 2017
 NC FIRE PROTECTION CODE v. 2018
 NC BUILDING CODE v. 2018
 NC RESIDENTIAL CODE v. 2018
 ACSE v. 7-10

SITE CONDITIONS

WIND SPEED: 117 MPH
 RISK CATEGORY: II
 EXPOSURE: B
 SNOW: 10 PSF

SHEET INDEX

- PV-1: COVER SHEET
- PV-2: PV STRUCTURAL
- PV-3: PV ELECTRICAL
- PV-4: PV EQUIPMENT LABELS
- PV-5: PV INSTALL GUIDE

DESIGNER INFO

DESIGNER: MCP
 ENGINEER: AWK
 DATE: 7/1/2022
 VERSION: P1

PV SYSTEM STRUCTURAL

PV-2.1

© 2019 NC SOLAR NOW EXPRESSLY RESERVES ITS COMMON LAW COPYRIGHT AND OTHER PROPERTY RIGHTS IN THESE PLANS. THESE PLANS ARE NOT TO BE REPRODUCED, CHANGED OR COPIED IN ANY FORM OR MANNER WHATSOEVER, NOR ARE THEY TO BE ASSIGNED TO ANY THIRD PARTY WITHOUT FIRST OBTAINING THE EXPRESSED WRITTEN PERMISSION AND CONSENT OF NC SOLAR NOW.

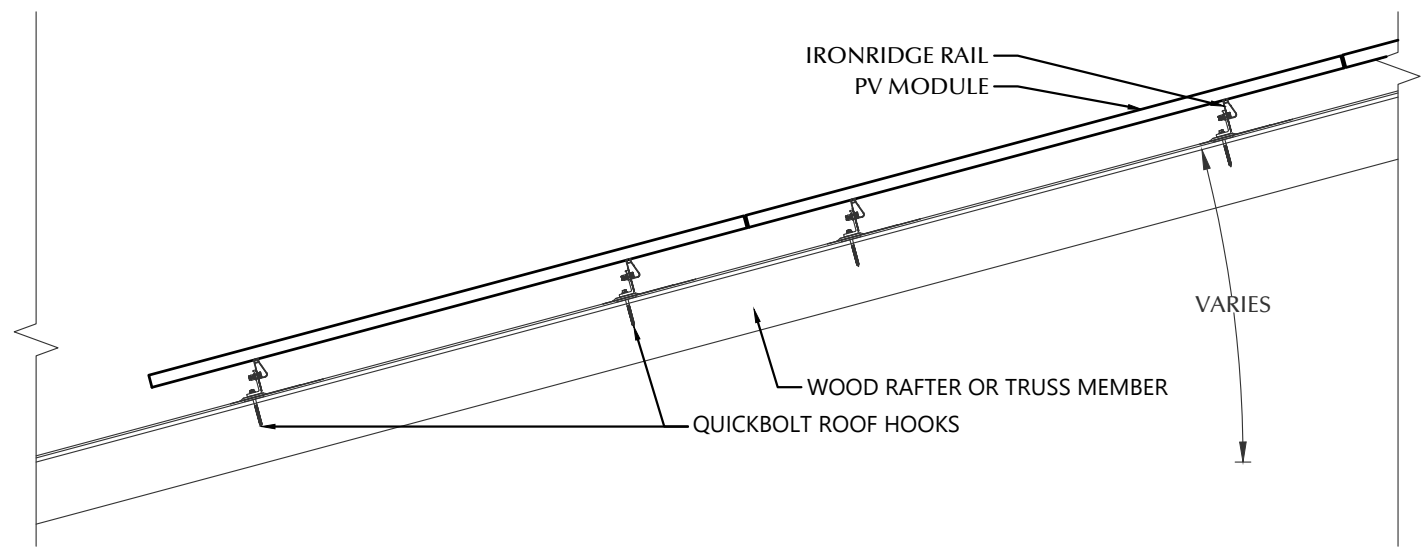

STATEMENT OF STRUCTURAL COMPLIANCE

THE EXISTING ROOF STRUCTURE HAS BEEN DESIGNED TO SUPPORT THE ADDITIONAL LOADS OF THE PROPOSED PV SYSTEM. IN ADDITION, THE RACKING AND FASTENING SYSTEM SHALL BE CAPABLE OF SECURING THE SYSTEM TO THE STRUCTURE UNDER DESIGN CONDITIONS WHEN INSTALLED PROPERLY AND IN ACCORDANCE WITH THE RACKING AND FASTENING ARRANGEMENT DETAILED WITHIN THESE DRAWINGS.

NAME: ANDREW W. KING, PE

SIGNED:

PV MODULES	
MAKE	REC
MODEL	REC365NP2
WIDTH	40.94 IN
LENGTH	69.10 IN
THICKNESS	30 MM
WEIGHT	44.00 LBS.
ARRAY AREA	79 SQFT.
ARRAY WEIGHT	196 LBS.

ROOF SUMMARY	
STRUCTURE:	
TYPE	TRUSSES
MATERIAL	SOUTHERN PINE #2
SIZE	2 X 4
SPACING	24 IN O.C.
ALLOWABLE SPAN	88 IN
PITCH	12/12
DENSITY	30 LBS./CU.FT.
DECKING:	
TYPE	OSB
MATERIAL	COMPOSITE
THICKNESS	7/16 IN
WEIGHT	1.60 LBS./SQFT
ROOFING:	
TYPE	ASPHALT SHINGLE
MATERIAL	ASPHALT
WEIGHT	2.30 LBS./SQFT.

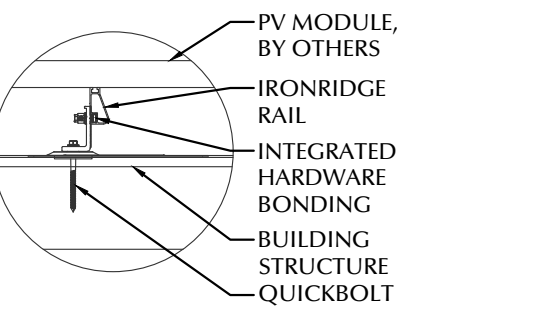
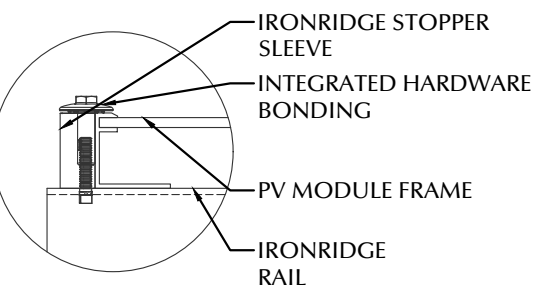
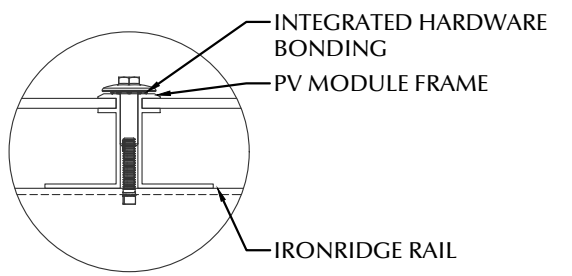
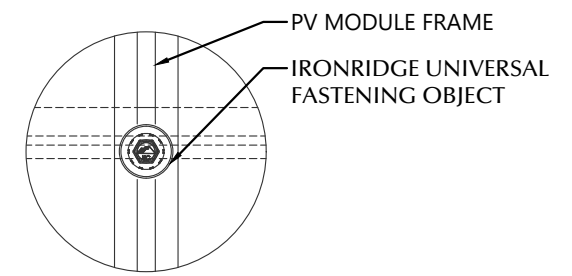
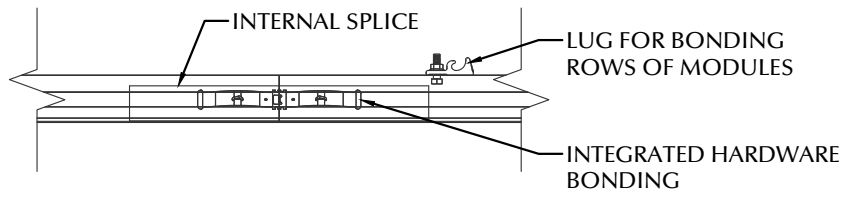

ROOF MOUNT SUMMARY		
MAXIMUM (IN)	MOUNT SPACING	RAIL OVERHANG
WIND ZONE 1	72 IN	19 IN
WIND ZONE 2	48 IN	19 IN
WIND ZONE 3	48 IN	19 IN

ROOF LOADING	
GROUND SNOW LOAD:	15 LBS./SQFT.
LIVE LOAD	20 LBS./SQFT.
DEAD LOAD	
ROOFING	3.9 LBS./SQFT.
PV ARRAY	2.5 LBS./SQFT.
TOTAL	6.4 LBS./SQFT.
WIND LOAD:	
UPLIFT ZONE 1	-24.6 LBS./SQFT.
UPLIFT ZONE 2	-29.0 LBS./SQFT.
UPLIFT ZONE 3	-29.0 LBS./SQFT.
DOWNWARD	23.0 LBS./SQFT.
FASTENER LOAD:	
UPLIFT ZONE 1	-423 LBS.
UPLIFT ZONE 2	-332 LBS.
UPLIFT ZONE 3	-332 LBS.
DOWNWARD	396 LBS.

1 ROOF FASTENER DETAIL
NOT TO SCALE

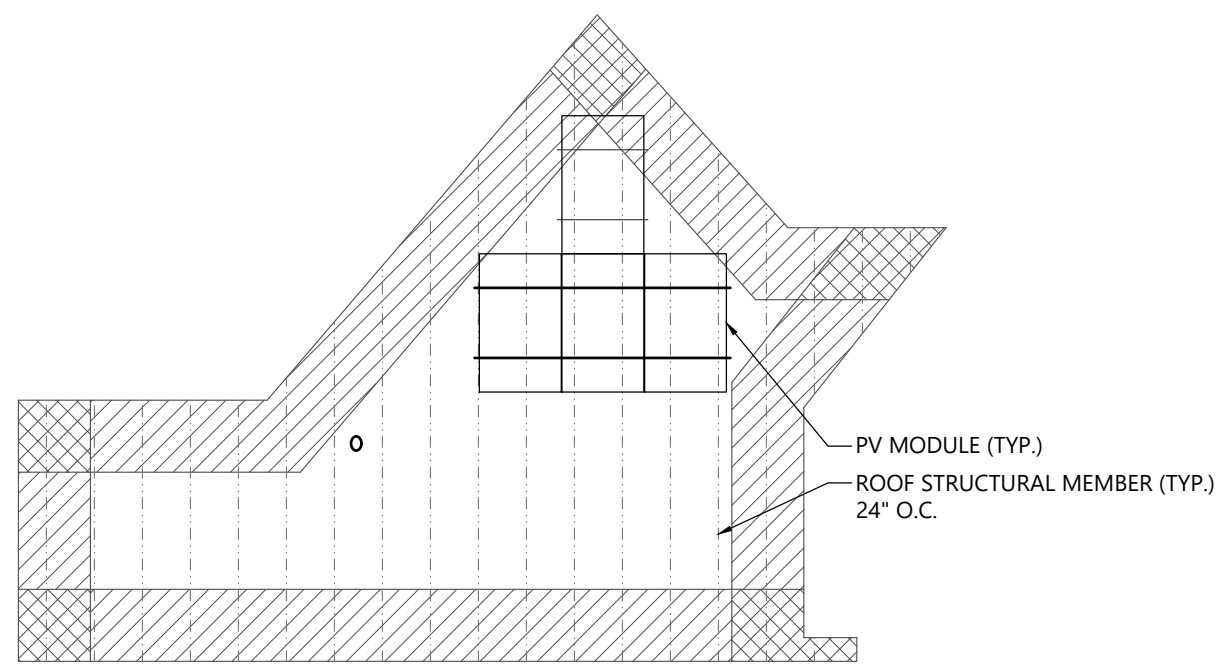

ROOF MOUNT & FASTENER	
ROOF MOUNT:	
MAKE	QUICKBOLT
MODEL	4 IN QB1
MATERIAL	STAINLESS / EPDM
FASTENER:	
MAKE	QUICK SCREWS
MODEL	HANGER BOLT
MATERIAL	304 SS
SIZE	5/16-18 X 5-1/4"
GENERAL:	
WEIGHT	0.56 LBS.
FASTENERS PER MOUNT	1
MAX. PULL-OUT FORCE	960.0 LBS.
SAFETY FACTOR	2
DESIGN PULL-OUT FORCE	480.0 LBS.

2 ROOF B ARRAY LAYOUT
1/8" = 1'-0"

MOUNTING RAILS	
MAKE	IRONRIDGE
MODEL	XR10
MATERIAL	ALUMINUM
WEIGHT	0.425 LBS/IN
SPACING	35 IN

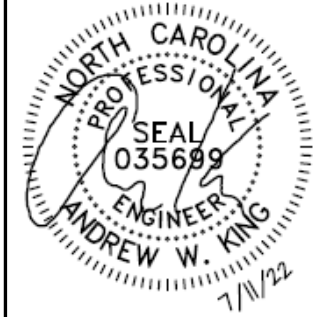

CLIENT INFO

PAVESIO ALVARO
185 ROBERTS RD
SANFORD, NC 27332

PROJECT INFO

DC INPUT: 12.410 kW
AC EXPORT: 9.860 kW
DOI INSPT. METHOD: OPTION 2

CODE REFERENCES

NATION ELECTRICAL CODE v. 2017
NC FIRE PROTECTION CODE v. 2018
NC BUILDING CODE v. 2018
NC RESIDENTIAL CODE v. 2018
ACSE v. 7-10

SITE CONDITIONS

WIND SPEED: 117 MPH
RISK CATEGORY: II
EXPOSURE: B
SNOW: 10 PSF

SHEET INDEX

PV-1: COVER SHEET
PV-2: PV STRUCTURAL
PV-3: PV ELECTRICAL
PV-4: PV EQUIPMENT LABELS
PV-5: PV INSTALL GUIDE

DESIGNER INFO

DESIGNER: MCP
ENGINEER: AWK
DATE: 7/1/2022
VERSION: P1

PV SYSTEM STRUCTURAL

PV-2.2

© 2019 NC SOLAR NOW EXPRESSLY RESERVES ITS COMMON LAW COPYRIGHT AND OTHER PROPERTY RIGHTS IN THESE PLANS. THESE PLANS ARE NOT TO BE REPRODUCED, CHANGED OR COPIED IN ANY FORM OR MANNER WHATSOEVER, NOR ARE THEY TO BE ASSIGNED TO ANY THIRD PARTY WITHOUT FIRST OBTAINING THE EXPRESSED WRITTEN PERMISSION AND CONSENT OF NC SOLAR NOW.

CONDUCTOR SCHEDULE

TAG	CURRENT CARRYING CONDUCTORS			GROUNDING CONDUCTORS			CONDUIT/RACEWAY			NOTES
	QTY.	SIZE	INSULATION	QTY.	SIZE	INSULATION	QTY.	SIZE	LOCATION	
C1	6	10 AWG	DG CABLE	1	6 AWG	BARE	-	-	FREE AIR	1
C2	6	10 AWG	THWN	1	10 AWG	THWN	1	3/4"	EXT/INT	2,4
C3	3	6 AWG	THWN	1	10 AWG	THWN	1	3/4"	EXT/INT	2,4
C4	3	6 AWG	THWN	1	6 AWG	THWN	1	3/4"	EXTERIOR	2,4
XC	-	-	-	-	-	-	-	-	-	3

NOTES:

1. MANUFACTURER PROVIDED, UL LISTED WIRING HARNESS FOR USE ON EXPOSED ROOFS
2. CONDUIT SIZE SHOWN IS CODE MINIMUM. LARGER SIZES ARE ALLOWED.
3. EXISTING CONDUCTORS, FIELD VERIFY
4. EQUIPMENT TERMINAL RATING SHALL BE A MINIMUM OF 75°C AT BOTH END OF CONDUCTOR

PV MODULE	
MAKE	REC
MODEL	REC365NP2
NOM. POWER (PNOM)	365 WATTS
NOM. VOLT. (VMPP)	34.3 VOLTS
O.C. VOLT (VOC)	40.9 VOLTS
MAX. SYS. VOLT.	1000 VOLTS
NOM. CURR. (IMPP)	10.7 AMPS
S.C. CURR. (ISC)	11.4 AMPS
TEMP. COEF. (PMPP)	-0.34 %/C
TEMP. COEF. (Voc)	-0.26 %/C
MAX SERIES FUSE	25 AMPS
UL COMPLIANT (Y/N)	YES

PV COMBINER PANEL	
MAKE	ENPHASE
MODEL	X-IQ-AM1-240-4
INPUT:	
MAX BRANCH CIRCUITS	4 TOTAL
BRANCH CIRCUIT OCPD	50 AMPS
OUTPUT:	
MAX POWER	15600 WATTS
NOM. VOLTAGE	240 VOLTS
BUS RATING	125 AMPS
MAIN BREAKER Y/N	NO
ENCL. RATING	NEMA TYPE 3R
UL LIST. (Y/N)	YES

DC / AC INVERTER	
MAKE	ENPHASE
MODEL	IQ7PLUS-72-US
DC INPUT:	
POWER RANGE (WATTS)	235-440
MIN/MAX START VOLT.	22 / 60
OPERATING VOLT. RANGE	16-60
MAX. CURRENT	15 AMPS
MODULE COMPATIBILITY	60 & 72 CELL
AC OUTPUT:	
MAX. POWER	295 WATTS
NOM. POWER	290 WATTS
NOM. VOLT.	211-240-264
MAX. CURR.	1.21 AMPS
DC DISC. (Y/N)	NO
RAPID SHUTDOWN (Y/N)	YES
PROTECT. RATING	NEMA TYPE 6
UL LIST. (Y/N)	YES
MAX BRANCH CIRCUIT	13

SUB PANEL (EXISTING)	
MAKE	GENERIC
MODEL	NA
ENCL. RATING	NEMA 3R
VOLT. RATING	240 VOLTS
BUS RATING	200 AMPS
UL LIST. (Y/N)	YES
MAIN BREAKER (Y/N)	YES (NEW)
MAIN BREAKER RATING	200 AMPS

JUNCTION BOX	
MAKE	SOLADECK
PROTECT. RATING	NEMA TYPE 3R
UL LIST. (Y/N)	YES

METER COMBO (EXISTING)	
MAKE	SQUARE D
MODEL	N/A
ENCL. RATING	NEMA 3R
VOLT. RATING	240
BUS RATING	N/A
UL LIST. (Y/N)	YES
MAIN BREAKER (Y/N)	YES
MAIN BREAKER RATING	200 AMPS

AC DISCONNECT	
MAKE	GENERIC
MODEL	NA
ENCL. RATING	NEMA 3R
VOLT. RATING	240 VOLTS
AMP RATING	60 AMPS
UL LIST. (Y/N)	YES
FUSED (Y/N)	YES
FUSE RATING	60 AMPS

- INSTALL NEW 200A MAIN BREAKER IN SUB PANEL

- BACK-FEED SOLAR OUTPUT VIA LOAD SIDE TAP IN BETWEEN OUTDOOR MAIN BREAKER AND SUB PANEL

- LOAD-BREAK RATED
- VISIBLE OPEN
- LOCKABLE IN OPEN POSITION
- INSTALL ADJACENT TO METER
- DISCONNECT TO BE READILY ACCESSIBLE TO UTILITY COMPANY PERSONNEL AT ALL TIMES

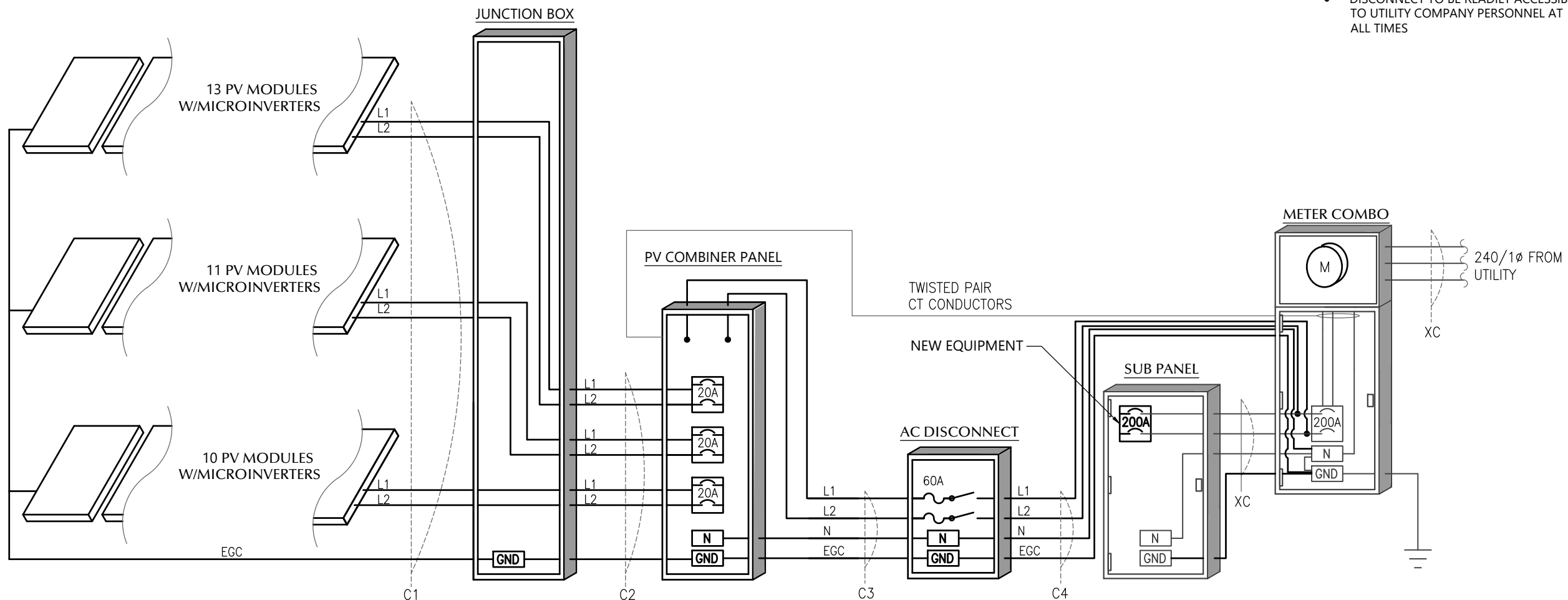

1 ELECTRICAL SCHEMATIC
NTS

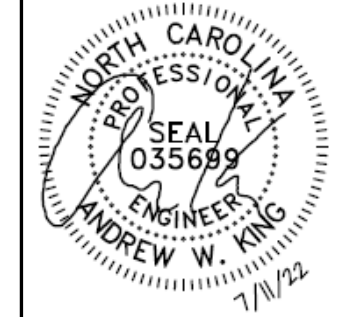

CLIENT INFO
 PAVESIO ALVARO
 185 ROBERTS RD
 SANFORD, NC 27332

PROJECT INFO
 DC INPUT: 12.410 kW
 AC EXPORT: 9.860 kW
 DOI INSPT. METHOD: OPTION 2

CODE REFERENCES
 NATION ELECTRICAL CODE v. 2017
 NC FIRE PROTECTION CODE v. 2018
 NC BUILDING CODE v. 2018
 NC RESIDENTIAL CODE v. 2018
 ACSE v. 7-10

SITE CONDITIONS
 WIND SPEED: 117 MPH
 RISK CATEGORY: II
 EXPOSURE: B
 SNOW: 10 PSF

SHEET INDEX
 PV-1: COVER SHEET
 PV-2: PV STRUCTURAL
 PV-3: PV ELECTRICAL
 PV-4: PV EQUIPMENT LABELS
 PV-5: PV INSTALL GUIDE

DESIGNER INFO
 DESIGNER: MCP
 ENGINEER: AWK
 DATE: 7/1/2022
 VERSION: P1

PV SYSTEM ELECTRICAL

PV-3.1

© 2019 NC SOLAR NOW EXPRESSLY RESERVES ITS COMMON LAW COPYRIGHT AND OTHER PROPERTY RIGHTS IN THESE PLANS. THESE PLANS ARE NOT TO BE REPRODUCED, CHANGED OR COPIED IN ANY FORM OR MANNER WHATSOEVER, NOR ARE THEY TO BE ASSIGNED TO ANY THIRD PARTY WITHOUT FIRST OBTAINING THE EXPRESSED WRITTEN PERMISSION AND CONSENT OF NC SOLAR NOW.

⚠ WARNING
ELECTRIC SHOCK HAZARD
 TERMINALS ON THE LINE AND LOAD SIDES MAY BE ENERGIZED IN THE OPEN POSITION

NEC 690.13 (B)
 PLACE ON PV SYSTEM DISCONNECTING MEANS.

⚠ WARNING
POWER SOURCE OUTPUT CONNECTION DO NOT RELOCATE THIS OVERCURRENT DEVICE

NEC 705.12 (B)(2)(3)(b)
 PLACE ADJACENT TO BACK-FED BREAKER

⚠ WARNING
DUAL POWER SUPPLY
 SOURCES: UTILITY GRID AND PV SOLAR ELECTRIC SYSTEM

NEC 705.12 (B)(3)
 PLACE ON ALL EQUIPMENT THAT IS SUPPLIED BY BOTH POWER SOURCES

WARNING: PHOTOVOLTAIC POWER SOURCE

NEC 690.31 (G)(3)&(4)
 PLACE ON ALL JUNCTION BOXES, EXPOSED RACEWAYS, AND OTHER WIRING METHODS EVERY 10' AND ON EVERY SECTION SEPARATED BY ENCLOSURES, WALLS, PARTITIONS, CEILINGS, OR FLOORS.

RAPID SHUTDOWN SWITCH FOR SOLAR PV SYSTEM

NEC 690.56 (C)(3)
 PLACE ON RAPID SHUTDOWN SWITCH OR EQUIPMENT WITH INTEGRATED RAPID SHUTDOWN *REFLECTIVE*

SOLAR PV SYSTEM EQUIPPED WITH RAPID SHUTDOWN

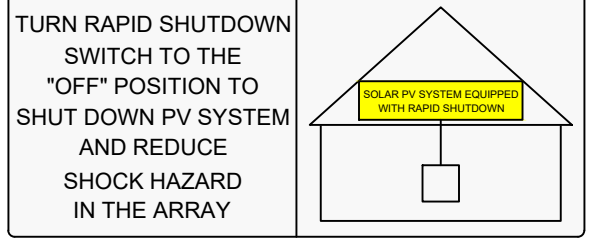

NEC 690.56 (C)(1)(a)
 PLACE WITHIN 3FT OF SERVICE DISCONNECTING MEANS TO WHICH THE PV SYSTEMS ARE CONNECTED AND SHALL INDICATE THE LOCATIONS OF RAPID SHUTDOWN SWITCHES

PV SYSTEM DISCONNECT

NEC 690.13 (B)
 PLACE ON PV SYSTEM DISCONNECTING MEANS.

PHOTOVOLTAIC POWER SOURCE
 OPERATING AC VOLTAGE 240 V
 MAXIMUM OPERATING AC OUTPUT CURRENT 41.14 A

NEC 690.54
 PLACE ON INTERCONNECTION DISCONNECTING MEANS

⚠ WARNING
 THIS EQUIPMENT FED BY MULTIPLE SOURCES. TOTAL RATING OF ALL OVERCURRENT DEVICES EXCLUDING MAIN SUPPLY OVERCURRENT DEVICE SHALL NOT EXCEED AMPACITY OF BUSBAR.

NEC 705.12 (B)(2)(3)(c)
 PLACE ON PV COMBINER PANEL.

SERVICE DISCONNECT LOCATED:
 NORTH-WEST SIDE OF HOUSE

PV DISCONNECT LOCATED:
 NORTH-WEST SIDE OF HOUSE

NEC 705.10
 PLACE AT SERVICE EQUIPMENT AND PV SYSTEM DISCONNECTING MEANS. FIELD VERIFY EQUIPMENT LOCATIONS AND LABEL ACCORDINGLY.

LABEL NOTES

1. LABELS SHOWN ARE HALF THEIR ACTUAL REQUIRED SIZE.
2. LABEL MATERIAL SHALL BE SUITABLE FOR THE EQUIPMENT ENVIRONMENT.
3. DC CONDUIT SHALL BE MARKED WITH REQUIRED LABEL EVERY 10 FEET.
4. LABELS WILL BE APPLIED IN ACCORDANCE WITH THE NEC. SOME LABELS MAY NOT BE NECESSARY.

DC WIRING NOTES

1. CONDUCTORS SHALL BE COPPER, RATED AT NOT LESS THAN 600 VOLTS FOR RESIDENTIAL CONSTRUCTION AND NOT LESS THAN 1000 VOLTS FOR COMMERCIAL CONSTRUCTION.
2. MINIMUM SIZE SHALL BE #10 AWG UNLESS OTHERWISE NOTED ON THE DRAWINGS.
3. EXPOSED WIRING CONDUCTOR INSULATION SHALL BE TYPE PV WIRE, USE-2, OR RHW-2 WHERE THE OUTER LAYER OF THE INSULATION IS UV, SUNLIGHT, AND MOISTURE RESISTANT.
6. EXTERIOR WIRING CONDUCTOR INSULATION SHALL BE TYPE THWN-2 AND INSTALLED IN ELECTRICAL METALLIC TUBING(EMT) OR RIGID POLYVINYL CHLORIDE CONDUIT(PVC). ALTERNATIVELY, METAL CLAD CABLE(MC) CAN BE USED AS WELL WHEN RATED FOR USE IN WET LOCATIONS.
7. INTERIOR WIRING CONDUCTOR INSULATION SHALL BE TYPE THHN-2 AND INSTALLED IN ELECTRICAL METALLIC TUBING(EMT), FLEXIBLE METAL CONDUIT(FMC), OR METAL CLAD CABLE(MC).
6. USE SCHEDULE 40 PVC OUTDOORS WHERE NOT SUBJECT TO PHYSICAL DAMAGE OR BELOW FLOOR SLAB. USE SCHEDULE 80 PVC OUTDOORS WHERE SUBJECT TO PHYSICAL DAMMAGE
7. MINIMUM CONDUIT SIZE TO BE 1/2".
8. WIRING METHODS TO CONFORM TO ARTICLES 330, 334, 348, 350, 352, 356, AND 358 OF THE 2017 NEC.

AC WIRING NOTES

1. CONDUCTORS SHALL BE COPPER RATED AT NOT LESS THAN 600 VOLTS.
2. MINIMUM SIZE SHALL BE #14 AWG UNLESS OTHERWISE NOTED ON THE DRAWINGS.
3. EXTERIOR WIRING CONDUCTOR INSULATION SHALL BE TYPE THWN AND INSTALLED IN ELECTRICAL METALLIC TUBING(EMT), RIGID POLYVINYL CHLORIDE CONDUIT(PVC), LIQUID-TIGHT FLEXIBLE METAL CONDUIT(LFMC), OR LIQUID-TIGHT FLEXIBLE NON-METALLIC CONDUIT(LFNC) . ALTERNATIVELY, METAL CLAD CABLE(MC) CAN BE USED AS WELL WHEN RATED FOR USE IN WET LOCATIONS.
4. INTERIOR WIRING CONDUCTOR INSULATION SHALL BE TYPE THHN AND INSTALLED IN ELECTRICAL METALLIC TUBING(EMT), FLEXIBLE METAL CONDUIT(FMC), METAL CLAD CABLE(MC), OR ROMEX.
5. USE SCHEDULE 40 PVC OUTDOORS WHERE NOT SUBJECT TO PHYSICAL DAMAGE OR BELOW FLOOR SLAB. USE SCHEDULE 80 PVC OUTDOORS WHERE SUBJECT TO PHYSICAL DAMMAGE
6. MINIMUM CONDUIT SIZE TO BE 1/2".
7. WIRING METHODS TO CONFORM TO ARTICLES 330, 334, 348, 350, 352, 356, AND 358 OF THE 2017 NEC.

CONSTRUCTION NOTES

1. ALL WORK IS TO BE PERFORMED IN ACCORDANCE WITH THE NEC, STATE, AND LOCAL APPLICABLE CODES.
2. FOLLOW MANUFACTURER'S INSTALLATION INSTRUCTIONS, BEST PRACTICES, AND SPECIFICATIONS.
3. ENSURE REQUIRED MAINTENANCE ACCESS AND CLEARANCES ARE MAINTAINED.
4. WIRES SHALL BE RATED AND LABELED "SUNLIGHT RESISTANT" WHERE EXPOSED TO AMBIENT CONDITIONS.
5. FUSES 0 - 600 AMPS SHALL BE UL CLASS "RK-1" LOW PEAK DUAL ELEMENT TIME DELAY WITH 200,000 AMPERE INTERRUPTING RATING AS MANUFACTURED BY BUSSMANN, UNLESS NOTED OTHERWISE.
6. ALL TERMINALS/LUGS SHALL BE 75° RATED. ALL TERMINALS, SPlicing CONNECTORS, LUGS, ETC SHALL BE IDENTIFIED FOR USE WITH THE MATERIAL (CU/AL) OF THE CONDUCTOR AND SHALL BE PROPERLY INSTALLED.
7. PROVIDE A PULLWIRE IN ALL EMPTY CONDUITS.
8. ALL PENETRATIONS THROUGH EXTERIOR ROOFS SHALL BE FLASHED IN A WATERPROOF MANNER.
9. ALL PENETRATIONS THROUGH ATTIC FIRE BARRIERS SHALL BE SEALED WITH FIRE-BARRIER SEALANT CAULK.
10. SUPPORT ALL CONDUIT AND EQUIPMENT IN ACCORDANCE W/ NEC. ANY SUSPENDED MATERIALS SHALL BE DIRECTLY SUPPORTED BY THE BUILDING STRUCTURE.
11. METAL CONDUIT COUPLINGS CAN BE COMPRESSION TYPE, THREADED, OR BE SET-SCREW TYPE. PLASTIC CONDUIT COUPLINGS TO BE SOCKET GLUED TYPE.
12. A COMPLETE GROUNDING SYSTEM SHALL BE PRESENT OR PROVIDED AND INSTALLED IN ACCORDANCE WITH ARTICLE 250 OF THE NEC, AND AS SHOWN ON THE DRAWINGS.
13. EACH ELECTRICAL APPLIANCE SHALL BE PROVIDED WITH A NAMEPLATE GIVING THE IDENTIFYING NAME AND THE RATING IN VOLTS AND AMPERES, OR VOLTS AND WATTS. IF THE APPLIANCE IS TO BE USED ON A SPECIFIC FREQUENCY OR FREQUENCIES, IT SHALL BE SO MARKED. WHERE MOTOR OVERLOAD PROTECTION EXTERNAL TO THE APPLIANCES IS REQUIRED, THE APPLIANCE SHALL BE SO MARKED.
14. WHERE APPLICABLE, GROUNDING ELECTRODE CONDUCTOR TO BE CONTINUOUS. GROUNDING CRIMPS TO BE IRREVERSIBLE.
15. PHOTOVOLTAIC SYSTEMS SHALL BE PERMANENTLY MARKED AT VARIOUS EQUIPMENT LOCATIONS TO IDENTIFY THAT A PHOTOVOLTAIC SYSTEM IS INSTALLED AND THAT VARIOUS DANGERS ARE PRESENT.
16. EACH PHOTOVOLTAIC SYSTEM DISCONNECTING MEANS SHALL BE PERMANENTLY MARKED TO IDENTIFY IT AS A PHOTOVOLTAIC SYSTEM DISCONNECT.
17. WHERE ALL TERMINALS OF A DISCONNECTING MEANS MAY BE ENERGIZED IN THE OPEN POSITION, A WARNING SIGN SHALL BE MOUNTED ON OR ADJACENT TO THE DISCONNECT.
18. A PERMANENT LABEL FOR THE DIRECT-CURRENT PHOTOVOLTAIC POWER SOURCE SHALL BE PROVIDED AT THE DC DISCONNECT MEANS.
19. A PERMANENT PLAQUE OR DIRECTORY, DENOTING ALL ELECTRIC POWER SOURCES SERVING THE PREMISES, SHALL BE INSTALLED AT EACH SERVICE EQUIPMENT LOCATION AND AT LOCATIONS OF ALL POWER PRODUCTION SOURCES.
20. ALL MODULE GROUND CONNECTIONS SHALL BE MADE IN ACCORDANCE WITH NEC SECTION 690.4 (C)
21. A NORTH CAROLINA REGISTERED DESIGN PROFESSIONAL WILL BE REQUIRED TO SEAL THE STRUCTURAL DESIGN AT THE TIME OF PERMIT APPLICATION IF ANY OF THE FOLLOWING EXIST AND ARE ATTESTED TO BY THE APPLICANT:
 - I. THE WEIGHT OF THE PV SYSTEM EXCEEDS THREE (3) POUNDS PER SQUARE FOOT(PSF)
 - II. THE ROOF POSSESSES MORE THAN ONE (1) LAYER OF ASPHALT SHINGLES
 - III. THE ROOFING MATERIAL CONSISTS OF A TYPE OTHER THAN ASPHALT SHINGLES OR METAL
 - IV. THE ROOF IS LOCATED IN A 140 MPH OR GREATER WIND ZONE



CLIENT INFO

PAVESIO ALVARO
 185 ROBERTS RD
 SANFORD, NC 27332

PROJECT INFO

DC INPUT: 12.410 kW
 AC EXPORT: 9.860 kW
 DOI INSPT. METHOD: OPTION 2

CODE REFERENCES

NATION ELECTRICAL CODE v. 2017
 NC FIRE PROTECTION CODE v. 2018
 NC BUILDING CODE v. 2018
 NC RESIDENTIAL CODE v. 2018
 ACSE v. 7-10

SITE CONDITIONS

WIND SPEED: 117 MPH
 RISK CATEGORY: II
 EXPOSURE: B
 SNOW: 10 PSF

SHEET INDEX

PV-1: COVER SHEET
 PV-2: PV STRUCTURAL
 PV-3: PV ELECTRICAL
 PV-4: PV EQUIPMENT LABELS
 PV-5: PV INSTALL GUIDE

DESIGNER INFO

DESIGNER: MCP
 ENGINEER: AWK
 DATE: 7/1/2022
 VERSION: P1

PV SYSTEM EQUIPMENT LABELS

PV-4.1

© 2019 NC SOLAR NOW EXPRESSLY RESERVES ITS COMMON LAW COPYRIGHT AND OTHER PROPERTY RIGHTS IN THESE PLANS. THESE PLANS ARE NOT TO BE REPRODUCED, CHANGED OR COPIED IN ANY FORM OR MANNER WHATSOEVER, NOR ARE THEY TO BE ASSIGNED TO ANY THIRD PARTY WITHOUT FIRST OBTAINING THE EXPRESSED WRITTEN PERMISSION AND CONSENT OF NC SOLAR NOW.

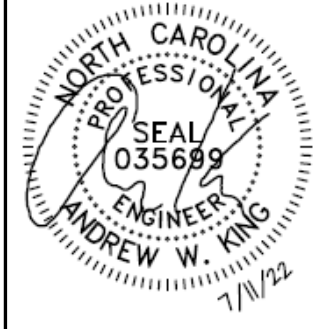
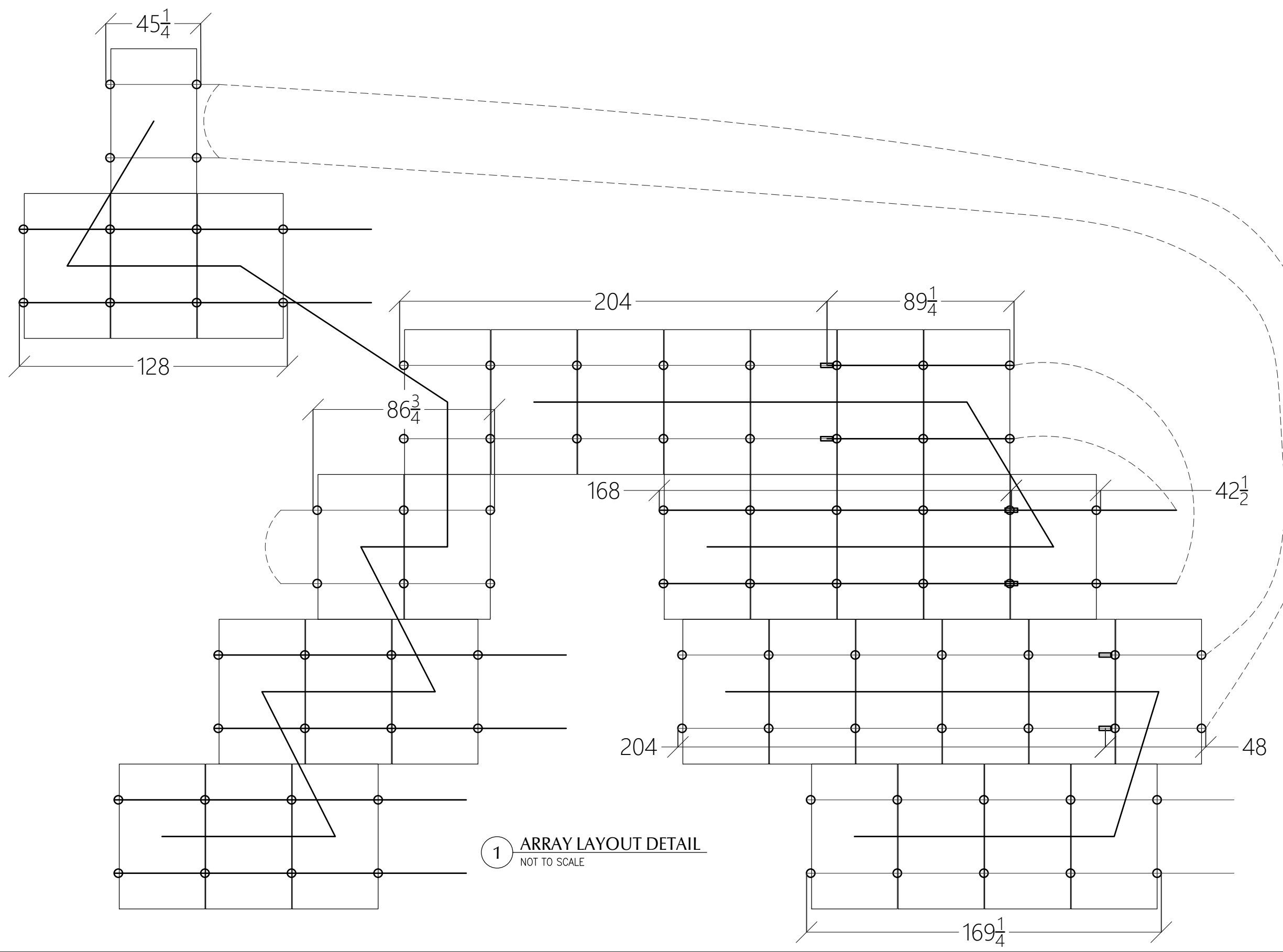

CLIENT INFO

PAVESIO ALVARO
185 ROBERTS RD
SANFORD, NC 27332

PROJECT INFO

DC INPUT: 12.410 kW
AC EXPORT: 9.860 kW
DOI INSPT. METHOD: OPTION 2

CODE REFERENCES

NATION ELECTRICAL CODE v. 2017
NC FIRE PROTECTION CODE v. 2018
NC BUILDING CODE v. 2018
NC RESIDENTIAL CODE v. 2018
ACSE v. 7-10

SITE CONDITIONS

WIND SPEED: 117 MPH
RISK CATEGORY: II
EXPOSURE: B
SNOW: 10 PSF

SHEET INDEX

PV-1: COVER SHEET
PV-2: PV STRUCTURAL
PV-3: PV ELECTRICAL
PV-4: PV EQUIPMENT LABELS
PV-5: PV INSTALL GUIDE

DESIGNER INFO

DESIGNER: MCP
ENGINEER: AWK
DATE: 7/1/2022
VERSION: P1

PV SYSTEM INSTALL GUIDE

PV-5.1

SOLAR'S MOST TRUSTED



REC N-PEAK 2 BLACK SERIES

PREMIUM FULL BLACK MONO
N-TYPE SOLAR PANELS



MONO N-TYPE: THE
MOST EFFICIENT C-SI
TECHNOLOGY



NO LIGHT INDUCED
DEGRADATION



SUPER-STRONG
FRAME UP TO 7000 PA
SNOW LOAD



FLEXIBLE
INSTALLATION
OPTIONS



FEATURING REC'S
PIONEERING
TWIN DESIGN



HIGH POWER
FOR 25 YEARS

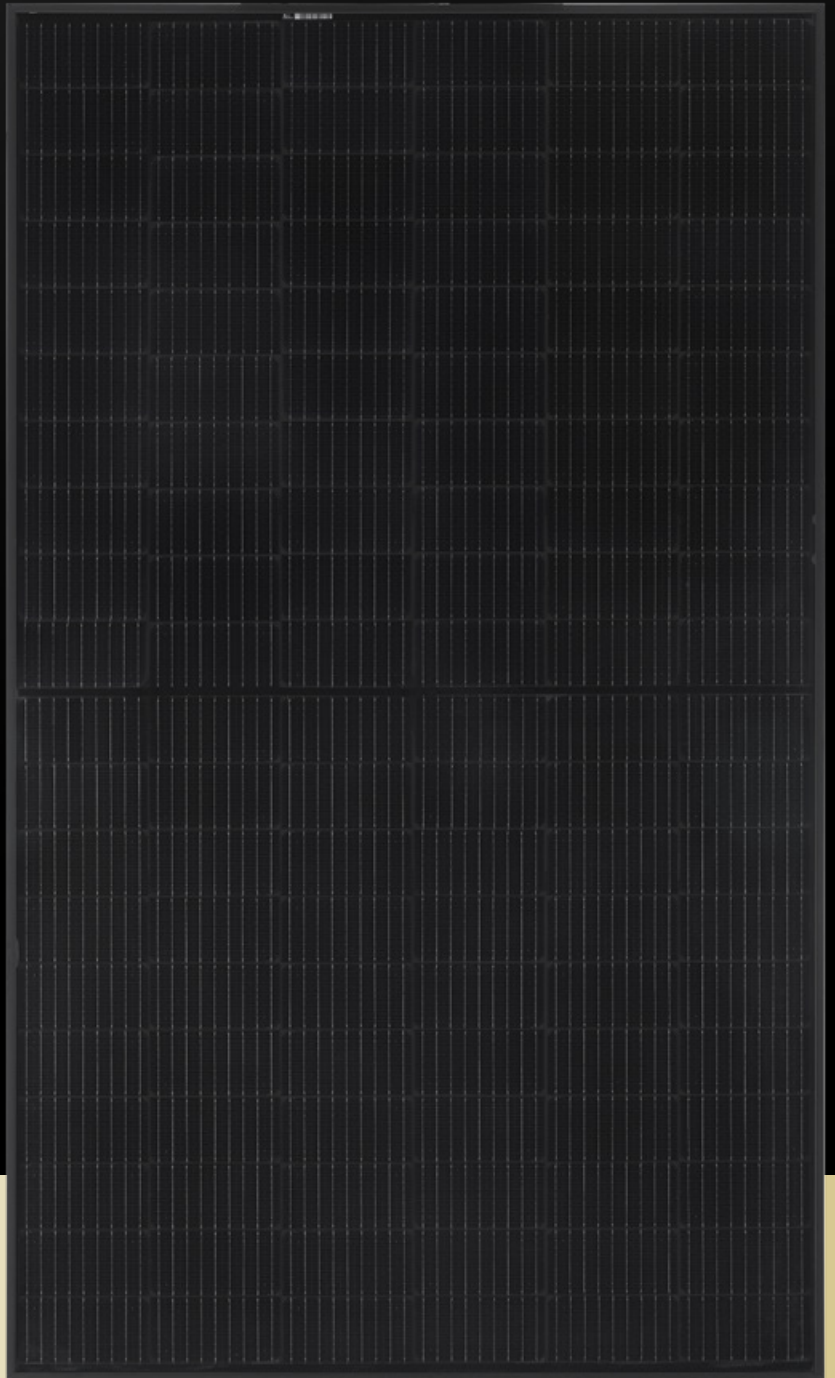

370
WP
POWER



ELIGIBLE

REC N-PEAK 2 BLACK SERIES

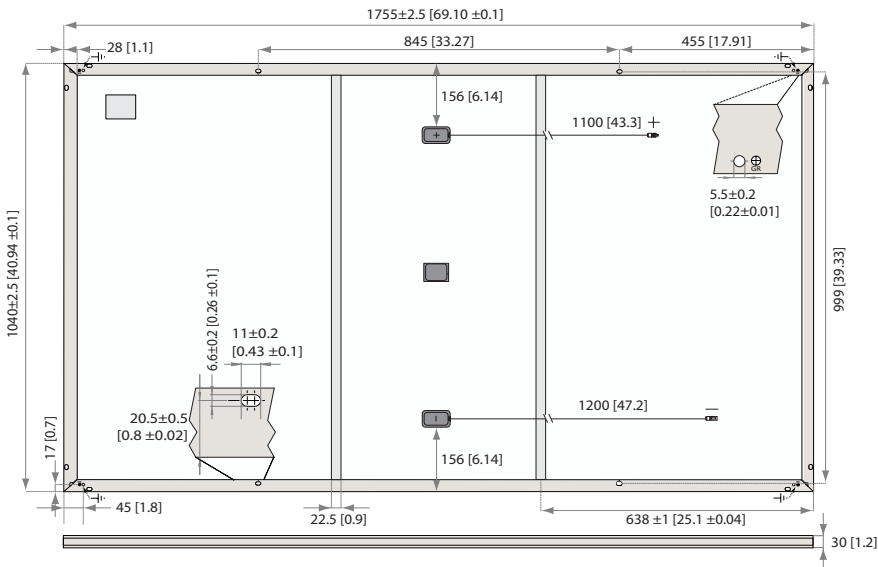

Measurements in mm [in]

ELECTRICAL DATA @ STC

Product code*: RECxxxNP2 Black

	355	360	365	370
Nominal Power - P_{MAX} (Wp)	355	360	365	370
Watt Class Sorting - (W)	0/+5	0/+5	0/+5	0/+5
Nominal Power Voltage - V_{MPP} (V)	33.5	33.9	34.3	34.7
Nominal Power Current - I_{MPP} (A)	10.60	10.62	10.65	10.68
Open Circuit Voltage - V_{OC} (V)	40.7	40.8	40.9	41.1
Short Circuit Current - I_{SC} (A)	11.27	11.31	11.36	11.41
Panel Efficiency (%)	19.4	19.7	20.0	20.3

Values at standard test conditions (STC: air mass AM1.5, irradiance 1000 W/m², temperature 25°C), based on a production spread with a tolerance of P_{MAX} , V_{OC} & I_{SC} ±3% within one watt class.* Where xxx indicates the nominal power class (P_{MAX}) at STC above.

ELECTRICAL DATA @ NOCT

Product code*: RECxxxNP2 Black

	268	272	276	280
Nominal Power - P_{MAX} (Wp)	268	272	276	280
Nominal Power Voltage - V_{MPP} (V)	31.3	31.7	32.1	32.5
Nominal Power Current - I_{MPP} (A)	8.56	8.58	8.60	8.63
Open Circuit Voltage - V_{OC} (V)	38.1	38.2	38.2	38.4
Short Circuit Current - I_{SC} (A)	9.10	9.13	9.18	9.22

Nominal operating cell temperature (NOCT: air mass AM1.5, irradiance 800 W/m², temperature 20°C, windspeed 1 m/s).
* Where xxx indicates the nominal power class (P_{MAX}) at STC above.

CERTIFICATIONS

IEC 61215:2016, IEC 61730:2016, UL 61730 (Pending)
ISO 14001:2004, ISO 9001:2015, OHSAS 18001:2007, IEC 62941



WARRANTY

	Standard	RECProTrust	
Installed by an REC Certified Solar Professional	No	Yes	Yes
System size	any	≤25kW	25-500kW
Product Warranty (yrs)	20	25	25
Power Warranty (yrs)	25	25	25
Labor Warranty (yrs)	0	25	10
Power in Year 1	98%	98%	98%
Annual Degradation	0.25%	0.25%	0.25%
Power in Year 25	92%	92%	92%

See warranty documents for details. Some conditions apply.

GENERAL DATA

Cell type:	120 half-cut mono c-Si n-type cells 6 strings of 20 cells in series
Glass:	0.13" (3.2 mm) solar glass with anti-reflection surface treatment
Backsheet:	Highly resistant polymeric construction (black)
Frame:	Anodized aluminum (black)
Junction box:	3-part, 3 bypass diodes, IP68 rated in accordance with IEC 62790
Cable:	12 AWG (4 mm ²) PV wire, 43 + 47" (1.1 m + 1.2 m) in accordance with EN 50618
Connectors:	Stäubli MC4 PV-KBT4/KST4, 12 AWG (4 mm ²) in accordance with IEC 62852 IP68 only when connected
Origin:	Made in Singapore

MECHANICAL DATA

Dimensions:	69.1 x 40.94 x 1.2 in (1755 x 1040 x 30 mm)
Area:	19.70 sq ft (1.83 m ²)
Weight:	44.0 lbs (20.0 kg)

MAXIMUM RATINGS

Operational temperature:	-40 ... +85°C
Maximum system voltage:	1000 V
Maximum test load (front):	+7000 Pa (146 psf)*
Maximum test load (rear):	-4000 Pa (83.5 psf)*
Max series fuse rating:	25 A
Max reverse current:	25 A

* See installation manual for mounting instructions.
Design load = Test load / 1.5 (safety factor)

TEMPERATURE RATINGS *

Nominal Operating Cell Temperature:	44.3°C (±2°C)
Temperature coefficient of P_{MAX} :	-0.34 %/°C
Temperature coefficient of V_{OC} :	-0.26 %/°C
Temperature coefficient of I_{SC} :	0.04 %/°C

*The temperature coefficients stated are linear values

LOW LIGHT BEHAVIOUR

Typical low irradiance performance of module at STC.

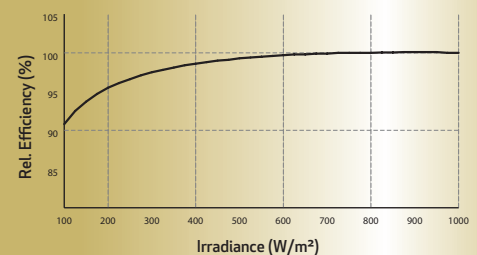

Founded in 1996, REC Group is an international pioneering solar energy company dedicated to empowering consumers with clean, affordable solar power. As Solar's Most Trusted, REC is committed to high quality, innovation, and a low carbon footprint in the solar materials and solar panels it manufactures. Headquartered in Norway with operational headquarters in Singapore, REC also has regional hubs in North America, Europe, and Asia-Pacific.

Enphase IQ 7 and IQ 7+ Microinverters

The high-powered smart grid-ready **Enphase IQ 7 Micro™** and **Enphase IQ 7+ Micro™** dramatically simplify the installation process while achieving the highest system efficiency.

Part of the Enphase IQ System, the IQ 7 and IQ 7+ Microinverters integrate with the Enphase IQ Envoy™, Enphase IQ Battery™, and the Enphase Enlighten™ monitoring and analysis software.

IQ Series Microinverters extend the reliability standards set forth by previous generations and undergo over a million hours of power-on testing, enabling Enphase to provide an industry-leading warranty of up to 25 years.

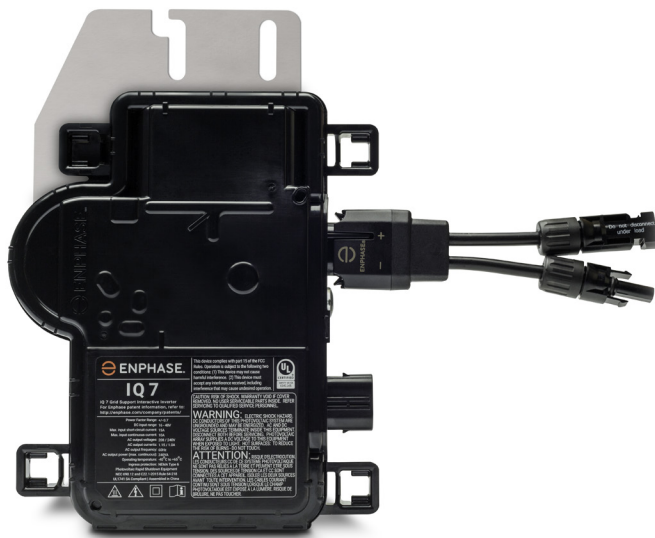

Easy to Install

- Lightweight and simple
- Faster installation with improved, lighter two-wire cabling
- Built-in rapid shutdown compliant (NEC 2014 & 2017)

Productive and Reliable

- Optimized for high powered 60-cell and 72-cell* modules
- More than a million hours of testing
- Class II double-insulated enclosure
- UL listed

Smart Grid Ready

- Complies with advanced grid support, voltage and frequency ride-through requirements
- Remotely updates to respond to changing grid requirements
- Configurable for varying grid profiles
- Meets CA Rule 21 (UL 1741-SA)

* The IQ 7+ Micro is required to support 72-cell modules.



Enphase IQ 7 and IQ 7+ Microinverters

INPUT DATA (DC)	IQ7-60-2-US / IQ7-60-B-US		IQ7PLUS-72-2-US / IQ7PLUS-72-B-US	
Commonly used module pairings ¹	235 W - 350 W +		235 W - 440 W +	
Module compatibility	60-cell PV modules only		60-cell and 72-cell PV modules	
Maximum input DC voltage	48 V		60 V	
Peak power tracking voltage	27 V - 37 V		27 V - 45 V	
Operating range	16 V - 48 V		16 V - 60 V	
Min/Max start voltage	22 V / 48 V		22 V / 60 V	
Max DC short circuit current (module I _{sc})	15 A		15 A	
Overvoltage class DC port	II		II	
DC port backfeed current	0 A		0 A	
PV array configuration	1 x 1 ungrounded array; No additional DC side protection required; AC side protection requires max 20A per branch circuit			
OUTPUT DATA (AC)	IQ 7 Microinverter		IQ 7+ Microinverter	
Peak output power	250 VA		295 VA	
Maximum continuous output power	240 VA		290 VA	
Nominal (L-L) voltage/range ²	240 V / 211-264 V	208 V / 183-229 V	240 V / 211-264 V	208 V / 183-229 V
Maximum continuous output current	1.0 A (240 V)	1.15 A (208 V)	1.21 A (240 V)	1.39 A (208 V)
Nominal frequency	60 Hz		60 Hz	
Extended frequency range	47 - 68 Hz		47 - 68 Hz	
AC short circuit fault current over 3 cycles	5.8 Arms		5.8 Arms	
Maximum units per 20 A (L-L) branch circuit ³	16 (240 VAC)	13 (208 VAC)	13 (240 VAC)	11 (208 VAC)
Overvoltage class AC port	III		III	
AC port backfeed current	0 A		0 A	
Power factor setting	1.0		1.0	
Power factor (adjustable)	0.85 leading ... 0.85 lagging		0.85 leading ... 0.85 lagging	
EFFICIENCY	@240 V	@208 V	@240 V	@208 V
Peak efficiency	97.6 %	97.6 %	97.5 %	97.3 %
CEC weighted efficiency	97.0 %	97.0 %	97.0 %	97.0 %
MECHANICAL DATA				
Ambient temperature range	-40°C to +65°C			
Relative humidity range	4% to 100% (condensing)			
Connector type (IQ7-60-2-US & IQ7PLUS-72-2-US)	MC4 (or Amphenol H4 UTX with additional Q-DCC-5 adapter)			
Connector type (IQ7-60-B-US & IQ7PLUS-72-B-US)	Friends PV2 (MC4 intermateable). Adaptors for modules with MC4 or UTX connectors: - PV2 to MC4: order ECA-S20-S22 - PV2 to UTX: order ECA-S20-S25			
Dimensions (WxHxD)	212 mm x 175 mm x 30.2 mm (without bracket)			
Weight	1.08 kg (2.38 lbs)			
Cooling	Natural convection - No fans			
Approved for wet locations	Yes			
Pollution degree	PD3			
Enclosure	Class II double-insulated, corrosion resistant polymeric enclosure			
Environmental category / UV exposure rating	NEMA Type 6 / outdoor			
FEATURES				
Communication	Power Line Communication (PLC)			
Monitoring	Enlighten Manager and MyEnlighten monitoring options. Both options require installation of an Enphase IQ Envoy.			
Disconnecting means	The AC and DC connectors have been evaluated and approved by UL for use as the load-break disconnect required by NEC 690.			
Compliance	CA Rule 21 (UL 1741-SA) UL 62109-1, UL1741/IEEE1547, FCC Part 15 Class B, ICES-0003 Class B, CAN/CSA-C22.2 NO. 107.1-01 This product is UL Listed as PV Rapid Shut Down Equipment and conforms with NEC-2014 and NEC-2017 section 690.12 and C22.1-2015 Rule 64-218 Rapid Shutdown of PV Systems, for AC and DC conductors, when installed according manufacturer's instructions.			

1. No enforced DC/AC ratio. See the compatibility calculator at <https://enphase.com/en-us/support/module-compatibility>.

2. Nominal voltage range can be extended beyond nominal if required by the utility.

3. Limits may vary. Refer to local requirements to define the number of microinverters per branch in your area.

To learn more about Enphase offerings, visit enphase.com



RSTC Enterprises Inc
2214 Heimstead Road
Eau Claire, WI 54703
715-830-9997



Outdoor Pass Thru enclosure: Asphalt/Cedar roof systems

Model - 0786-3R

ETL Listed and labeled
Report # 3125796 CRT-001b Revised March 2012

- UL50 Type 3R, 11 Edition Electrical
- equipment enclosures
- CSA C22.2 # 94-M91 special purpose
- enclosures (2006)

Basic specifications

Material - 18 Gauge Galvanized 90 Steel Base/Cover
Process - Seamless draw (stamped)
Flashing - 15" x 15"
Height - 2.625"
Cavity - 8" x 9" x 2.5" (162 Cubic inches)
Finish - Powder coat (1100 hours salt spray)

Assembly:

- Cavity Base and cover hole punched for matched assembly
- Base flashing pre-punched for roof deck mounting
- Cavity Base - 5 predetermined dimples for fittings or conduit

Base Plate Attachment:

- 16 gauge galvanized steel
- Fastened to base flashing with toggle fastening system
- Finish – Powder coat (1100 hours salt spray)
- 5 roof deck knockouts
- Knockout sizes – (3) .5", (1) .75" , and (1) 1"
- Rail 7" slotted 35mm

Ground – Installed with steel stud and star nut
Dual position Wire size - 2/0-14
Located with ground sticker

Strain Relief Clip – Aluminum riveted installation

Hardware Installation Pack:

7 - 1" Truss head screws
4 - .5" 8-32 thread cutting screws
4 - Bonded seal washers #10
2 - 10-32 1/2" Steel studs
2 - 10-32 3/8" steel star nuts
1 - Foam gasket seal
1 - Installation instructions

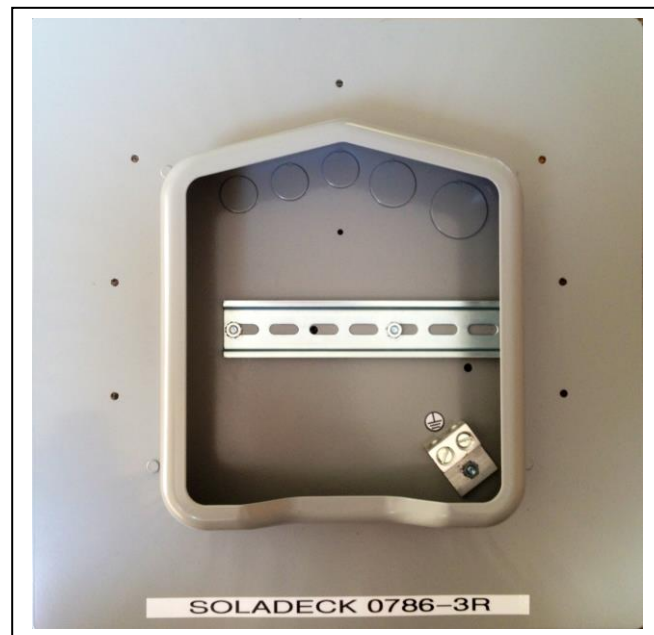

With 2 string DC pass thru kit
Kit Part # 01602
***** Kit sold separately**

Installation Manual
For SolaDeck Models 0783-41 and 0786-41

Table of Contents:

Warranty2

SolaDeck Mounting instructions3

Safety Instructions, General Wiring.....4

Requirements5

SolaDeck Features6

Base Centering dimples.....7

Base Plate Configuration7

Fuse Holder and Bus8

Installed Equipment Examples 0783-41 & 0786-41.....9

PV Panel Wiring Example.....10

First Edition - February 2009

RSTC Enterprises Inc
2219 Heimstead Road
Eau Claire, Wi 54703
866-367-7782

Warranty Information:

Thank you for your purchase. As with all manufactured devices repairs may be needed due to damage, unauthorized use, or defect.

- Warranty repairs must conform to warranty terms.
- Equipment must be installed according to the instructions and manuals provided.
- Products returned, must be Packaged, properly addressed and shipped prepaid.
- There is no additional allowance or reimbursement for installer or user labor or travel time required to disconnect, service or reinstall the damaged component(s).
- RSTC will ship a replacement product prepaid to addresses in the continental United States.
- In the event of a product malfunction, RSTC will not bear any responsibility for resulting losses, expenses, or damage to other components.

**DO NOT PROCEED WITH INSTALLATION UNTIL YOU HAVE READ
ENTIRE INSTRUCTIONS INCLUDING WARNINGS**

WARNING! STOP

**DO NOT WORK ON ROOF IF SURFACE IS WET,
FROSTED, ICE OR SNOW COVERED.
USE LADDERS SAFELY
USE HAND & EYE PROTECTION WHEN
WORKING WITH POWER TOOLS
USE EXTREME CAUTION TO AVOID CONTACT
WITH POWER LINES. CONTACT WITH POWER
LINES, ELECTRIC LIGHTS OR POWER CIRCUITS
MAY BE FATAL**

Installation of this product should be attempted only by individuals skilled in the use of the tools and equipment necessary for installation. Protect you and all persons and property during installation. If you have any doubt concerning your competence or expertise, consult a qualified expert to perform the installation. R.S.T.C. Enterprises Incorporated assumes no responsibility for the failure of an architect, contractor, installer, or building owner to comply with all applicable laws, building codes and requirements, and adequate safety precautions.

One Year Limited Warranty

Important: Evidence of original purchase is required for warranty service.

WARRANTOR: RSTC Enterprises Incorporated

ELEMENTS OF WARRANTY: RSTC warrants for one year to the original retail owner, this SolaDeck is free from defects in materials and craftsmanship with only the limitations or exclusions set out below.

WHAT IS NOT COVERED: This warranty covers only defects in materials and workmanship provided by RSTC Enterprises, and does not cover equipment damage or malfunction from misuse, abuse, accident, and act of God. Installation must be in accordance with our written instructions. RSTC Enterprises will not be liable for any installation charges associated with replacement, incidental or consequential damages resulting from your use of or inability to use the SolaDeck.

REMEDY: Your only remedy under this warranty is the exchange or replacement in the event that the product does not conform to this warranty. This warranty gives you specific legal rights, and you may also have other rights, which vary from state to state.

CLAIMS PROCESS: To make a claim under this warranty, the product should be shipped postage paid, with original purchase receipt to:

**RSTC ENTERPRISES
2219 HEIMSTEAD ROAD
EAU CLAIRE, WI 54703**

1-866-367-7782 or www.commdeck.com

m
nc

Tools and Hardware List

Utility Knife - #2 Phillips Head Driver Bit- Pry Bar – Roof sealant – Cordless Drill

A – (7) # 10 – 1” Phillips head wood screws

B – (4) 8-32 – ½” Phillips head threading machine screws

C – (4) #10 Bonded seal washers

D – (2) 10-32 – ½” Steel studs

E – (2) # 10 Star washers

F – (2) 10-32 – 3/8” steel nuts

SolaDeck Installation Instructions

1. Determine the location for the SolaDeck on the roof surface.
2. Use the template from the SolaDeck Carton and position it $\frac{3}{4}$ " below the shingle line. Trace the outline on the roof (Fig. 1).
3. Use a pry bar to loosen the shingles and remove any nails that will interfere with the flashing sliding beneath the shingles (Fig. 2).
4. Cut the roofing material to the template shape.
5. Inside of the base there are three knockout sizes. Remove the one (s) needed for the conduit fitting (s).
6. Slide the SolaDeck with flashing beneath the shingles into place and trace the knockout hole (s) (Fig. 3).
7. Drill out the traced knockout hole (s) $\frac{1}{3}$ larger than the knockout.
8. Slide the SolaDeck base back into place and fasten it to the roof deck with the 1" truss head screws provided. (Fig 4).
9. Use a quality roof sealant to seal the shingles to the SolaDeck flashing.
10. With the base installed, you have several options to wire the SolaDeck enclosure. Use either the sump built into the base or the predetermined centering dimples to knock out a hole for the fitting or conduit size you choose.
 - Dimples at the corners of the base allow for $\frac{1}{2}$ " or $\frac{3}{4}$ " fittings.
 - Dimples below the sump allow for $\frac{1}{2}$ " fittings.
 - These dimple positions accept conduit, liquid tight or strain relief fittings.
11. Peel off the tape on the foam Gasket and position it on the inside of the cover where it will contact the base sump.
12. When connections are complete, finish by fastening the cover to the base using the 8-32 screws with bonded seal washers provided.

*NOTE: Extra steel studs are provided for installing an isolated negative terminal or power distribution block

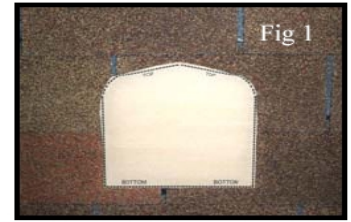

IMPORTANT SAFETY INSTRUCTIONS

SAVE THESE INSTRUCTIONS- This manual contains important instructions for models 0783-41 and 0786-41 that shall be followed during installation of the combiner.

SolaDeck models are listed by ETL as PV Combiners under the standard:

UL 1741, First Edition

SolaDeck models meet UL 50 Type 3R rainproof requirements.

This enclosure is rated for up to 600 VDC fuses.

Grounding Instructions- Each system should be connected to a grounded, permanent wiring system. **All system wiring and system grounding must comply with NEC Code, ANSI/NFPA 70-1996, or other appropriate codes, is the responsibility of the installer.**



The equipment ground on SolaDeck is marked with the symbol:

Note: Solar panels produce electrical current when lighting is present, even during overcast weather. Do not wire from the array to the SolaDeck combiner. Complete all connections inside the SolaDeck combiner first and then connect the array.

General Wiring Installation Instructions

- Remove any necessary knockouts before securing the SolaDeck to the roof or other surface.
- Follow the mounting instructions page 3
- Slide the fuse holders onto the Din rail and lock in place.
- Secure the Bus Bar to the fuse holders.
- Install the negative power distribution block using the steel studs in the location designated for the Negative PV Model (0783).
- Install negative terminal blocks on DIN rail where designated PV Negative and lock in place. Model (0786).
- Connect all wires to fuse holders, bus bar lug and negative terminals, securing them according to the listed torque values **from table on page 5.**
- **Conduit and Strain relief fittings and hubs must comply with UL 514B**

Requirements

- Use minimum 75 C copper
- Use only code approved, appropriately listed fuse holders and Fuses

Maximum Fuse Rating	30 AMP , 600 Volt
Total Maximum Current Rating	0783-41 / 0786-41 120 AMPS DC
Maximum Fuse Short Circuit Current	10ka
Fuse Holder Torque	13.6 in lb Flat or Phillips Head Driver
Din Rail Mounted Terminal Block Torque	9 - 14 in lb Flat Head Driver

Torque Data* for Box Lug

Wire Size		Torque	
AWG	mm2	in lbs	Nm
14-10	2.1-5.3	35	4
8	8.4	40	4.5
6-4	13.3-21.2	45	5.1
2	13.3-21.2	50	5.7

Torque Data* for Negative Power Distribution Block

Wire Size		Torque		
AWG	mm2	Screw Driver	External Drive Wrench	Nm
		in lbs		
14-10	2.1-5.3	35	75	4
8	8.4	40	75	4.5
6-4	13.3-21.2	45	110	5.1
Main 2/0-14	13.3-21.2	0	120	5.7

Torque Data* for Ground Lug

Wire Size		Torque	
AWG	mm2	in lbs	Nm
14-10	2.1-5.3	35	4
8	8.4	40	4.5
6-4	13.3-21.2	45	5.1
2-2/0	13.3-21.2	50	5.7

SolaDeck Combiner Features

- Stamped Seamless Galvanized Steel
- Powder Coated Surfaces
- Mounting Hardware Included
- Flashes into the roof deck
- 6" DIN rail installed Model (0786)
- 3" DIN rail installed Model (0783)
- 2 Position Ground lug installed
- 3 Roof deck knockouts .5", .75", 1"
- 5 Centering dimples for enter/exit strain or conduit fittings
- Accommodates fuse holders with combiner bus

SolaDeck cover on base **Fig 1**

Four 8-32 3/8" phillips head self thread screws and boded seal washers secure the SolaDeck cover



Figure 1

SolaDeck Base showing dimples Fig 2
Corner dimples support .5" or .75" fittings or conduit
Center dimples support .5" fittings or conduit



Figure 2

Base plate configuration Fig 3
Three knockouts for roof deck penetration .5", .75", 1"

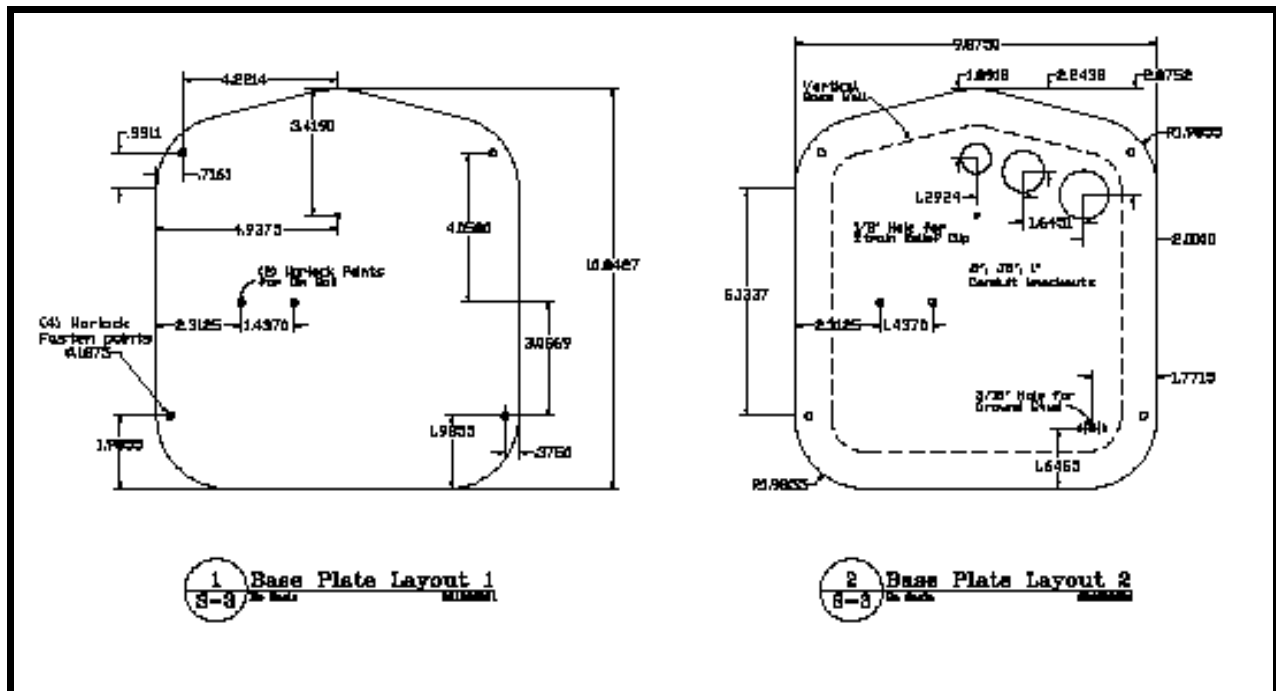

Figure 3

Fuse holders with bus Bar Fig 4

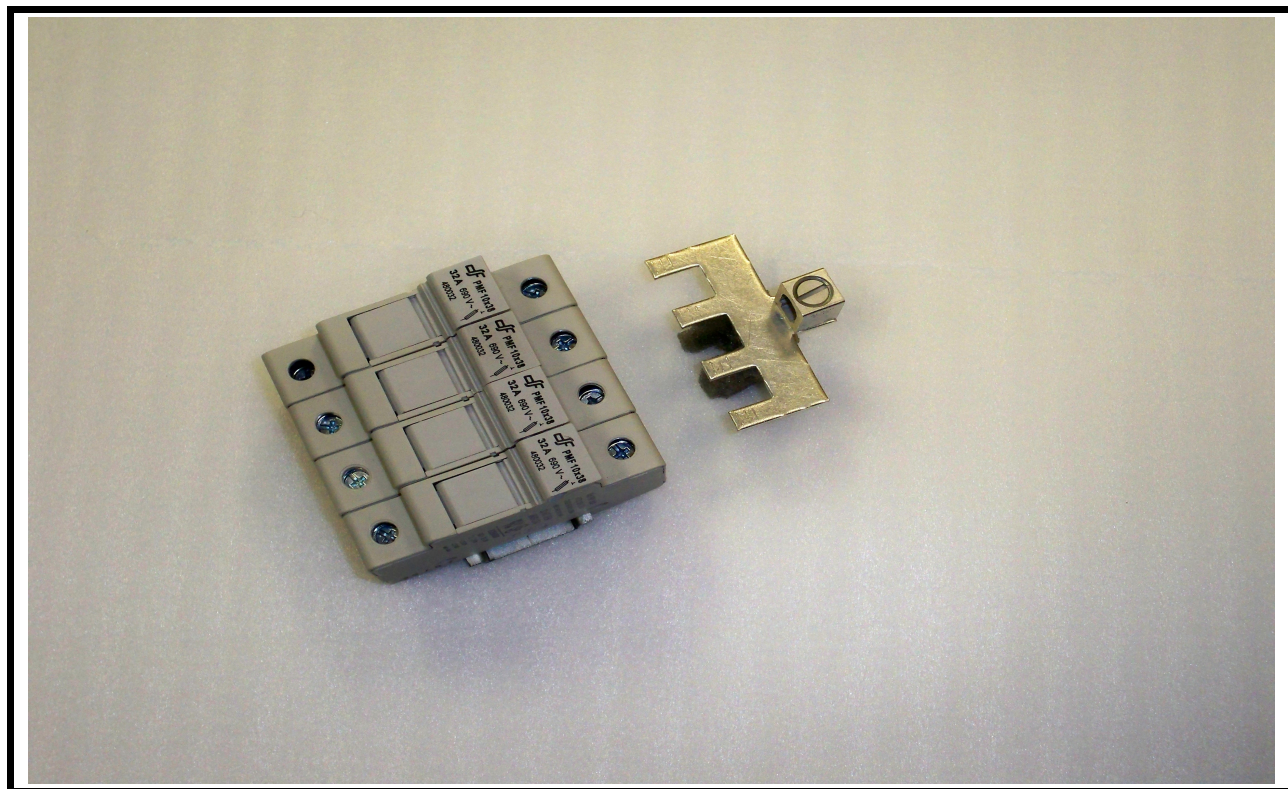

Figure 4

SolaDeck Models with cover off



Model 0786-41



Model 0783-41

PV Panel Example

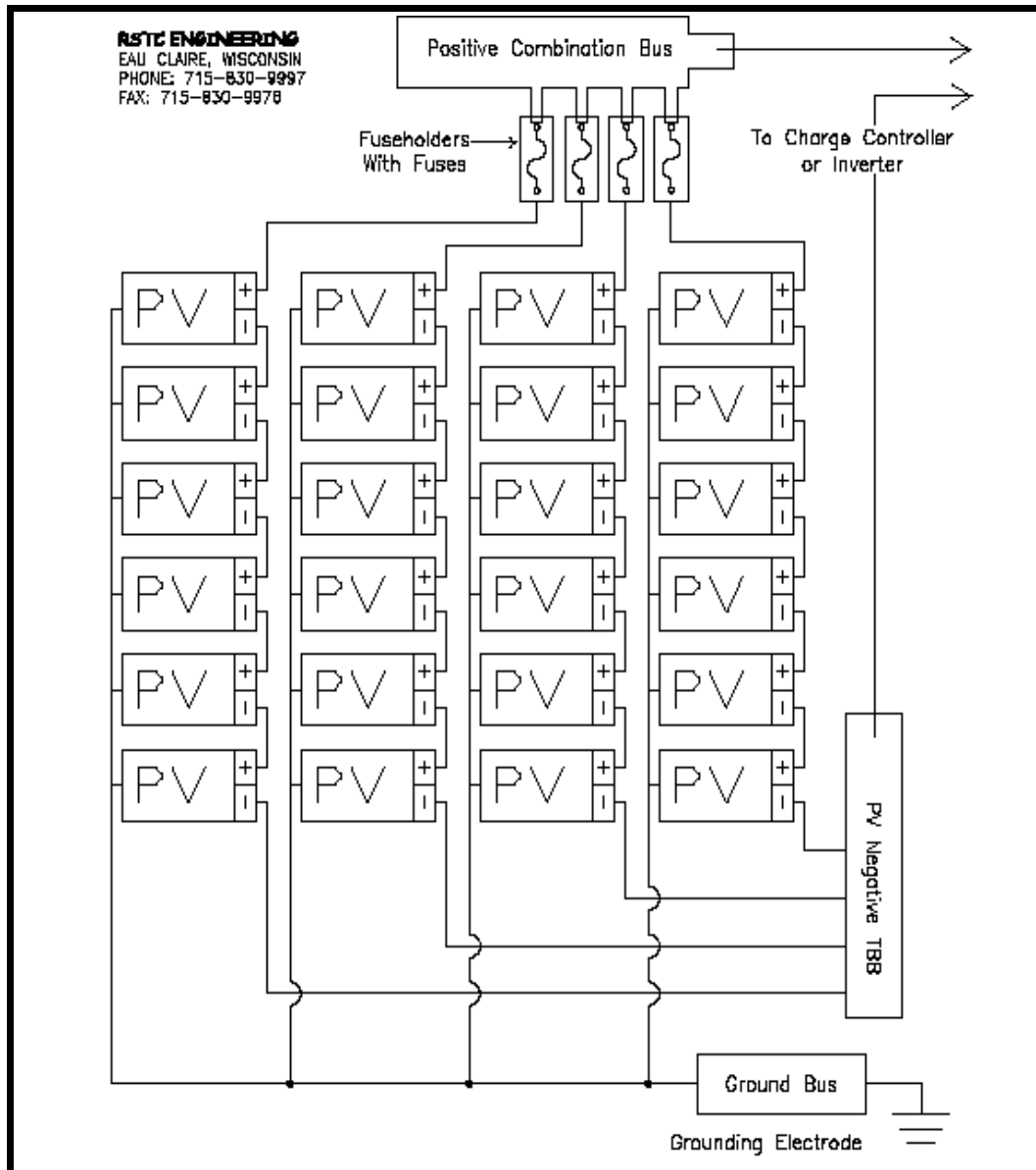

FLUSH MOUNT

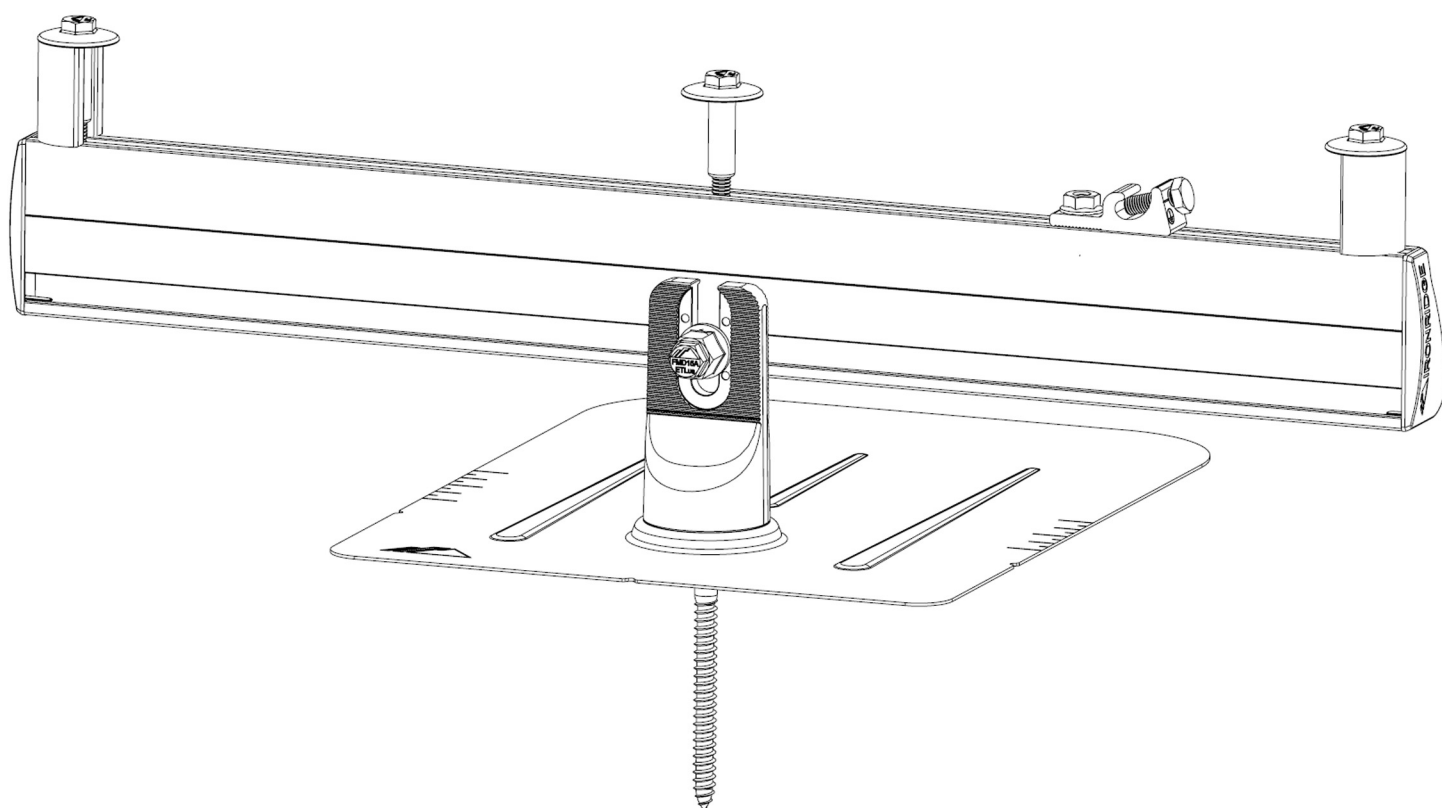

CONTENTS

DISCLAIMER	1
RATINGS	2
MARKINGS	2
CHECKLIST	3
1. ATTACH BASES	4
2. PLACE RAILS	4
3. SECURE LUGS	5
4. SECURE MODULES	5
CAMO	6
EXPANSION JOINTS	7
ELECTRICAL DIAGRAM	7
FLASHFOOT2	8
ALL TILE HOOK	8
KNOCKOUT TILE	8
FLAT ROOF ATTACHMENT	9
END CAPS	9
WIRE CLIPS	9
FLUSH STANDOFFS	9
MICROINVERTER KITS	10
SYSTEMS USING ENPHASE MICROINVERTERS OR SUNPOWER AC MODULES	10
SYSTEMS USING PHAZR MICROSTORAGE PRODUCTS	10
FRAMELESS MODULE KITS	11
MODULE COMPATIBILITY	11

DISCLAIMER

This manual describes proper installation procedures and provides necessary standards required for product reliability. Warranty details are [available on website](#). All installers must thoroughly read this manual and have a clear understanding of the installation procedures prior to installation. Failure to follow these guidelines may result in property damage, bodily injury or even death.

IT IS THE INSTALLER'S RESPONSIBILITY TO:

- Ensure safe installation of all electrical aspects of the array. All electrical installation and procedures should be conducted by a licensed and bonded electrician or solar contractor. Routine maintenance of a module or panel shall not involve breaking or disturbing the bonding path of the system. All work must comply with national, state and local installation procedures, product and safety standards.
- Comply with all applicable local or national building and fire codes, including any that may supersede this manual.
- Ensure all products are appropriate for the installation, environment, and array under the site's loading conditions.
- Use only IronRidge parts or parts recommended by IronRidge; substituting parts may void any applicable warranty.
- Review the [Design Assistant](#) and [Certification Letters](#) to confirm design specifications.
- Ensure provided information is accurate. Issues resulting from inaccurate information are the installer's responsibility.
- Ensure bare copper grounding wire does not contact aluminum and zinc-plated steel components, to prevent risk of galvanic corrosion.
- If loose components or loose fasteners are found during periodic inspection, re-tighten immediately. If corrosion is found, replace affected components immediately.
- Provide an appropriate method of direct-to-earth grounding according to the latest edition of the National Electrical Code, including NEC 250: Grounding and Bonding, and NEC 690: Solar Photovoltaic Systems.
- Disconnect AC power before servicing or removing modules, AC modules, microinverters and power optimizers.
- Review module manufacturer's documentation for compatibility and compliance with warranty terms and conditions.

RATINGS

UL 2703 LISTED



- Conforms to STD UL 2703 (2015) Standard for Safety First Edition: Mounting Systems, Mounting Devices, Clamping/Retention Devices, and Ground Lugs for Use with Flat-Plate Photovoltaic Modules and Panels.
- Max Overcurrent Protective Device (OCPD) Rating: 25A
- Max Module Size: 24ft²
- Module Orientation: Portrait or Landscape
- CAMO Specific Allowable Design Load Rating: 50 PSF downward, 50 PSF upward, 15 PSF lateral
- System Level Allowable Design Load Rating: meets minimum requirements of the standard (10 PSF downward, 5 PSF upward, 5 PSF lateral). Actual system structural capacity is defined by PE stamped [certification letters](#).

CLASS A SYSTEM FIRE RATING PER UL 1703

- Any Roof Slope with Module Types 1, 2, and 3
- Any module-to-roof gap is permitted, with no perimeter guarding required. This rating is applicable with any third-party attachment.
- Class A rated PV systems can be installed on Class A, B, and C roofs without affecting the roof fire rating.

WATER SEAL RATINGS: UL 441 & TAS 100(A)-95 (FLASHFOOT2, ALL TILE HOOK, KNOCKOUT TILE)

- Tested and evaluated without sealant.
- Any roofing manufacturer approved sealant is allowed. Ratings applicable for roof slopes between 2:12 and 12:12

STRUCTURAL CERTIFICATION

- Designed and Certified for Compliance with the International Building Code & ASCE/SEI-7

MARKINGS

Product markings are located on the 3/8" flange hex nut or Grounding Lug bolt head.

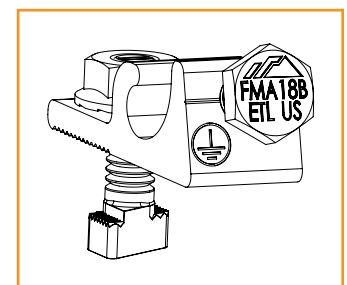
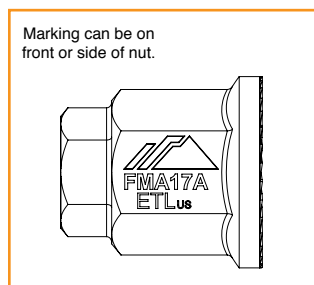
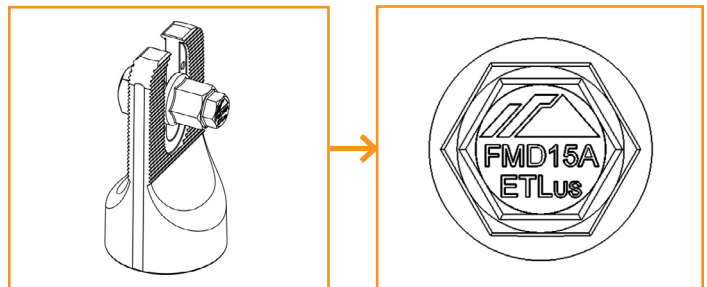

CHECKLIST

PRE-INSTALLATION

- Verify module compatibility. See [Page 10](#) for info.

TOOLS REQUIRED

- Cordless Drill (non-impact)
- Impact Driver (for lag bolts)
- Torque Wrench (0-250 in-lbs)
- 5/16" Socket
- 7/16" Socket
- 1/2" Socket
- String Line

TORQUE VALUES

- FlashFoot2 Lag Bolts (7/16" Socket): Fully Seat
- Bonded Splice Screws (5/16" Socket): 20 in-lbs
- Grounding Lug Nuts (7/16" Socket): 80 in-lbs
- Grounding Lug Terminal Screws (7/16" Socket): 20 in-lbs
- Universal Fastening Object (7/16" Socket): 80 in-lbs
- Expansion Joint Nuts (7/16" Socket): 80 in-lbs
- Flush Standoffs (1/2" Socket): 132 in-lbs
- Microinverter Kit Nuts (7/16" Socket): 80 in-lbs
- Frameless Module Kit Nuts (7/16" Socket): 80 in-lbs
- 3/8" Bonding Hardware Nuts (7/16" Socket): 250 in-lbs
- All Tile Hook Lags (7/16" Socket): Fully Seat
- All Tile Hook Carriage Bolts (7/16" Socket): 132 in-lbs
- Knockout Tile Lags (1/2" Socket): Fully Seat
- Knockout Tile Nuts (1/2" Socket): 132 in-lbs
- Flat Roof Attachment Nuts (9/16" Socket): 250 in-lbs

💡 If using previous version of: FlashFoot, Integrated Grounding Mid Clamps, Grounding Lug, End Clamps, and Expansion Joints please refer to Alternate Components Addendum (Version 1.20).

IRONRIDGE COMPONENTS

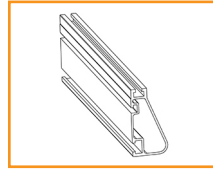

XR Rail

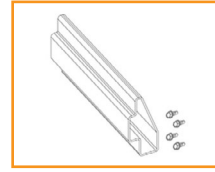

Bonded Splice

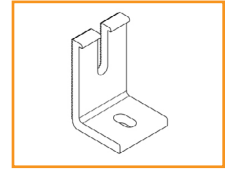

L-Foot

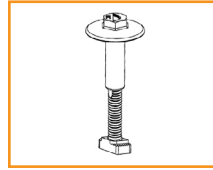

UFO

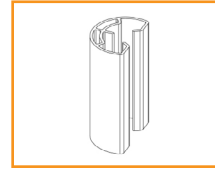

Stopper Sleeve

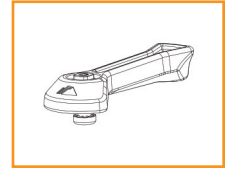

CAMO

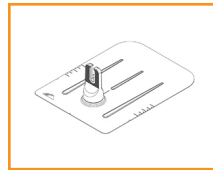

FlashFoot2

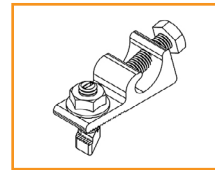

Grounding Lug

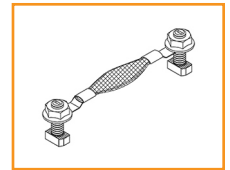

Expansion Joint



End Cap



Wire Clip

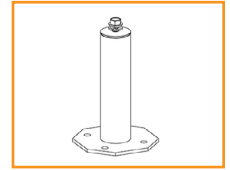

Flush Standoff

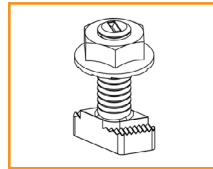

Microinverter Kit

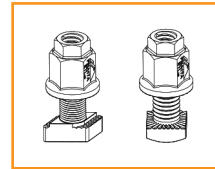

3/8" Bonding Hardware

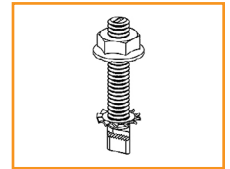

Frameless Module Kit

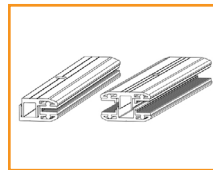

Frameless End/Mid Clamp

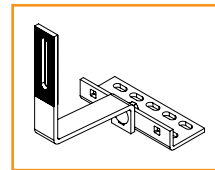

All Tile Hook

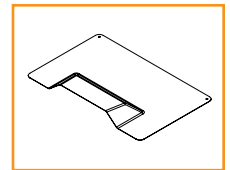

All Tile Hook Flashing

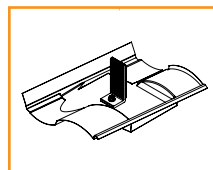

Knockout Tile

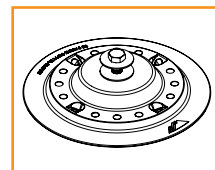

Flat Roof Attachment

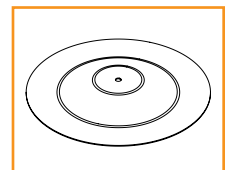

Membrane Flashing

1. ATTACH BASES

For composition roofs, refer to FlashFoot2 install instructions on [page 8](#). For tile roofs, refer to All Tile Hook and Knockout Tile install instructions on [page 8](#) and [9](#). For flat roofs, refer to Flat Roof Attachment install instructions on [page 9](#). When using approved third party attachments, refer to manufacturer's install instructions.

💡 **Tested or evaluated third-party roof attachments:**

- [Anchor Products](#) - U-Anchor
- [S-5! Standing Seam Metal Roof Clamps](#) - Certification of metal roof clamps includes bonding to both painted and galvalume metal roofs. Tighten S-5! and S-5! Mini set screws to 130-150 in-lbs (≥ 24 gauge) or 160-180 in-lbs (22 gauge) roofs. Tighten S-5! M10 bolt to 240 in-lbs or S-5! Mini M8 bolt to 160 in-lbs. Use the following fastening guidelines for other S-5! roof clamps: ProteaBracket™ - firmly seat roof screws and tighten hinge bolt to 225 in-lbs; RibBracket™ - firmly seat roof screws and tighten M8 bolt (M8-1.25 x 22mm sold separately) to 160 in-lbs; and SolarFoot™ - firmly seat roof screws and tighten M8 flange nut to 160 in-lbs.
- [EcoFasten Green Fasten GF-1 Anchors](#)
- Rooftech RT-Mini - Attach to L-foot using 5/16-18 x 1.25" stainless steel bolt and nut torqued to 132 in-lbs.
- QuickMount PV [Roof Mounts](#) QMLM/QMLM - ST and [Tile Hooks](#) - Tile Hook attaches to XR Rail using 3/8" Bonding Hardware Kit torqued to 250 in-lbs.
- Quickscrews Solar Roof Hooks, Ejot Aluminum Roof Hooks, Unirac Creotecc Tile Hooks, or Solarhooks - Attach to XR Rails with L-Foot or 3/8" Bonding Hardware Kit torqued to 250 in-lbs.
- Pegasus Comp Mount - Attach to XR Rail using 3/8" Bonding Hardware kit torqued to 250 in-lbs.

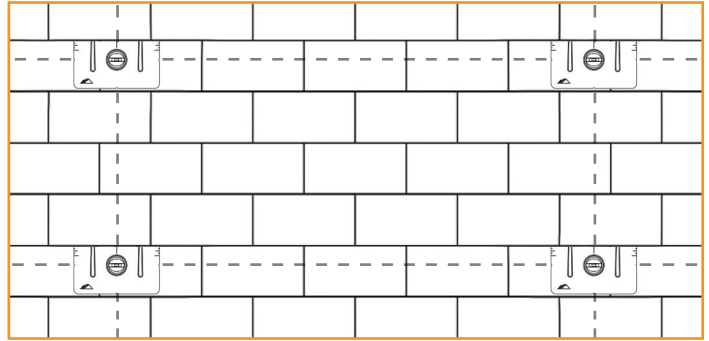

2. PLACE RAILS

A. CONNECT SPLICES

Use Bonded Splices, when needed, to join multiple sections of rail. Insert Bonded Splice 6" into first rail and secure with two self-drilling screws, spacing them approximately 1" apart and tightening to **20 in-lbs**. Slide second rail over Bonded Splice and secure with two more self-drilling screws.

- 💡 Rows exceeding 100 feet of rail must use [Expansion Joints](#).
- 💡 For XR10 and XR100 rails, insert screws along the provided lines.
- 💡 Refer to Structural Certification letters for rail splice location requirements.
- 💡 Screws can be inserted on front or back of rails.

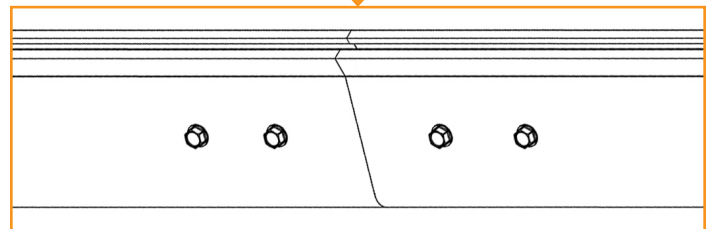
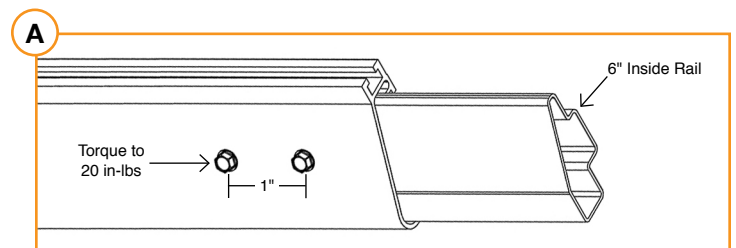

B. PREPARE HARDWARE

Slide square-headed bolts into side-facing rail slot. Space out bolts to match attachment spacing.

- 💡 Tape ends of rail, to keep bolts from sliding out while moving.
- 💡 If using T-bolts, carry hardware onto roof and proceed.

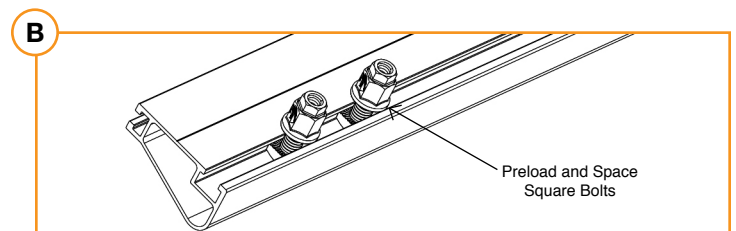

C. ATTACH RAILS

Drop rail with hardware into roof attachment. Level rail at desired height, then torque to **250 in-lbs**.

- 💡 Rail can face either upslope or downslope on roof.

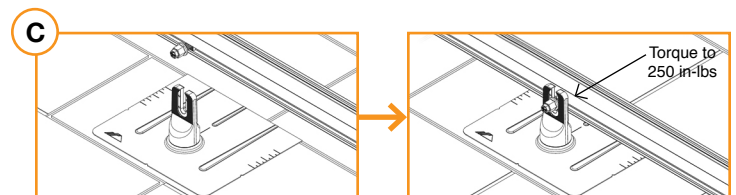

3. SECURE LUGS

Insert T-bolt in top rail slot and torque hex nut to **80 in-lbs**. Install a minimum 10 AWG solid copper or stranded grounding wire. Torque terminal screw to **20 in-lbs**.

- 💡 Ground Lugs are only needed on one rail per continuous row of modules, regardless of row length (unless frameless modules are being used, see [Page 9](#)).
- 💡 If using Enphase microinverters or Sunpower AC modules, Grounding Lugs may not be needed. See [Page 9](#) for more info.
- 💡 Grounding Lugs can be installed anywhere along the rail and in either orientation shown. If installing lug underneath modules in areas with ground snow loads greater than 40 psf, place lug within 4 inches module frame edge.

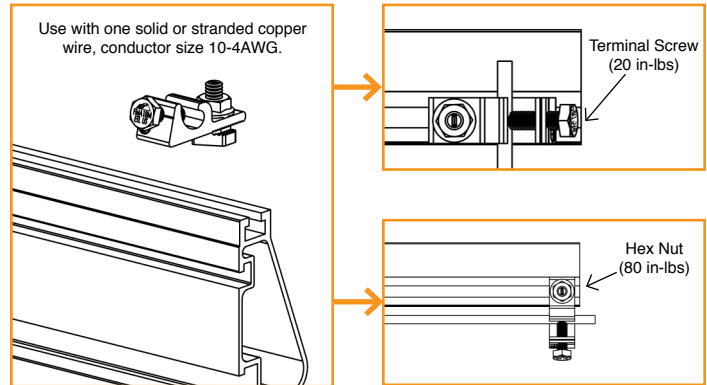

4. SECURE MODULES

A. SECURE FIRST END

Place first module in position on rails, a minimum of 1" from rail ends. Snap Stopper Sleeves onto UFO. Fasten module to rail using the UFO, ensuring that the UFO is hooked over the top of the module. Torque to **80 in-lbs**.

- 💡 Ensure rails are square before placing modules.
- 💡 Hold Stopper Sleeves on end while torquing to prevent rotation.
- 💡 If using CAMO instead of UFO + Stopper Sleeve, refer to [Page 6](#) for CAMO installation procedure.

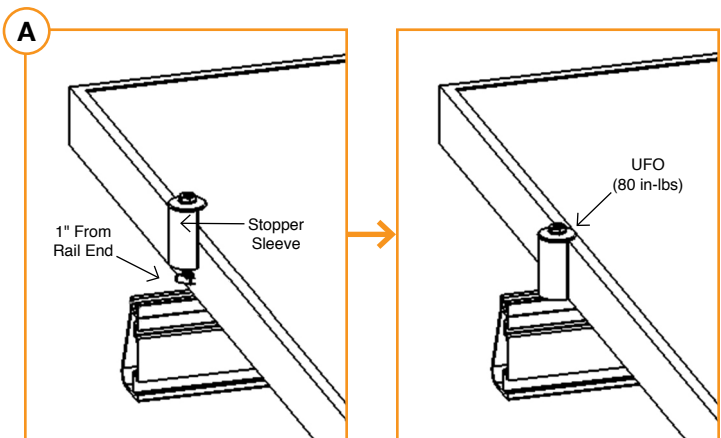

B. SECURE NEXT MODULES

Place UFO into each rail, placing them flush against first module. Slide second module against UFO. Torque to **80 in-lbs**. Repeat for each following module.

- 💡 When reinstalling UFO, move modules a minimum of 1/16" so UFOs are in contact with a new section of module frame.
- 💡 When UFOs are loosened and re-tightened, ensure UFO T-bolt bottoms out in rail channel before re-torquing UFO to achieve full engagement between T-bolt and rail.
- 💡 If using Wire Clips, refer to [Page 9](#).

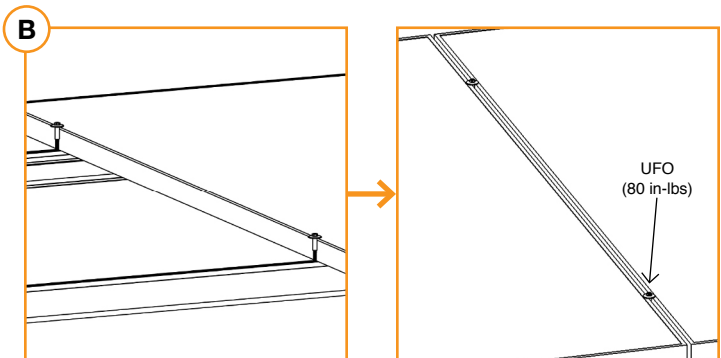

C. SECURE LAST END

Place last module in position on rails, a minimum of 1" from rail ends. Snap Stopper Sleeves onto UFO. Secure UFO Clamps on rails, ensuring they are hooked over top of module. Torque to **80 in-lbs**.

- 💡 Hold Stopper Sleeves on end while torquing to prevent rotation.
- 💡 Repeat all steps for each following row of modules, leaving a minimum 3/8" gap between rows.
- 💡 If using CAMO instead of UFO + Stopper Sleeve, refer to [Page 6](#) for CAMO installation procedure.

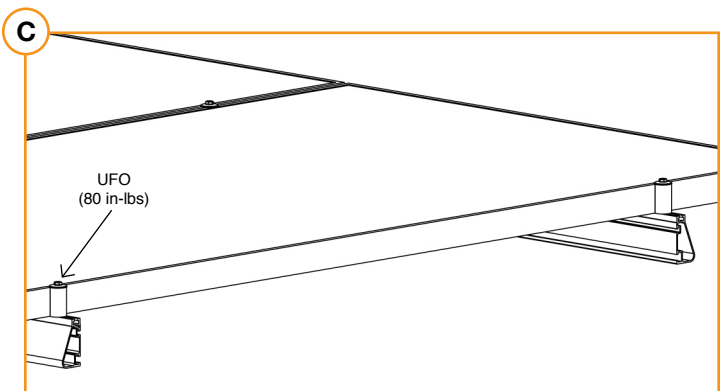

A. SLIDE INTO RAIL

Slide CAMO into rail channel far enough to clear the module frame. CAMO requires 6" of clearance from end of rail.

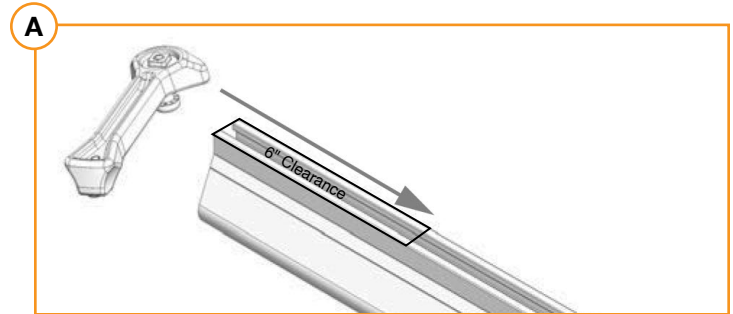

B. PLACE MODULE

Place module on rails (module cells not shown for clarity). When installing CAMO the module can overhang the rail no more than 1/4".

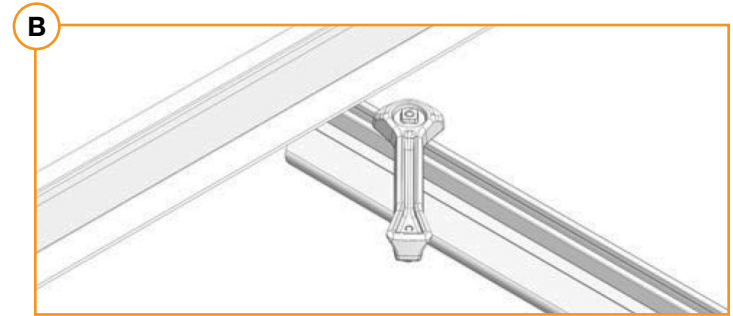

C. PULL TOWARDS END

Pull CAMO towards rail ends, at 45 degree angle, so the bonding bolt contacts the module flange edge.

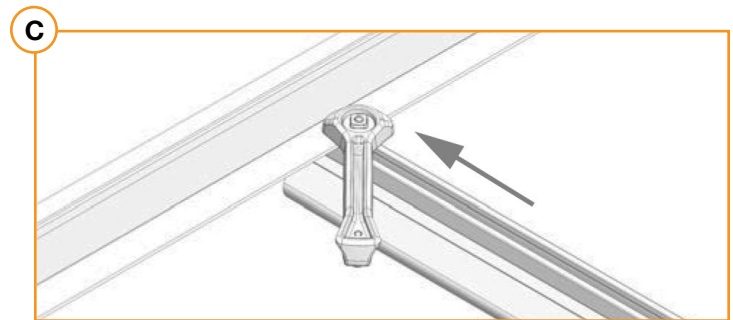

D. SECURE TO FRAME

Rotate handle with an upwards motion until CAMO snaps into rail channel. Ensure CAMO bonding pins are fully seated on top of module frame.

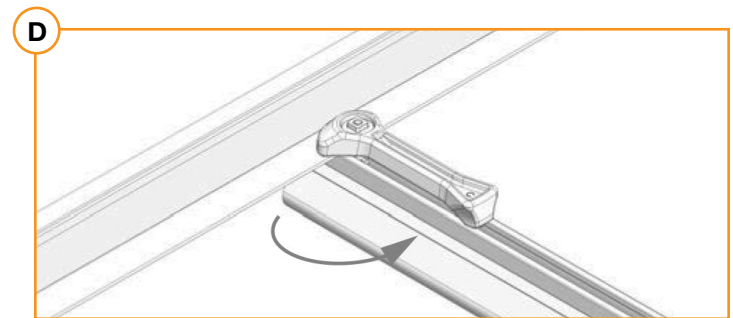

FRAME COMPATIBILITY

CAMO has been tested or evaluated with all modules listed in the Module Compatibility section having frames within the referenced dimensions. Be sure the specific module being used meets the dimension requirements.

💡 For installations with Hanwha Q CELLS modules with 32 mm frame heights, the maximum ground snow is 45 PSF (33 PSF module pressure).

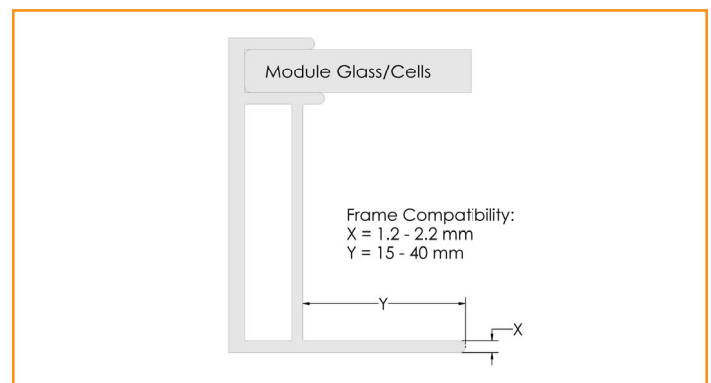

EXPANSION JOINTS

GROUNDING STRAP EXPANSION JOINT

Grounding Strap Expansion Joints are required for thermal expansion of rows exceeding 100 feet of rail.

Insert Internal Splice into first rail and secure with screw. Assemble and secure Grounding Strap 3/8" from rail end. Slide second rail over Internal Splice leaving 1" gap between rails. Attach other end of Grounding Strap with hardware, and torque hex nuts to **80 in-lbs**.

💡 **Second Bonded Splice screw is not used with Expansion Joints.**

💡 **Do not install module over top of expansion joint location.**

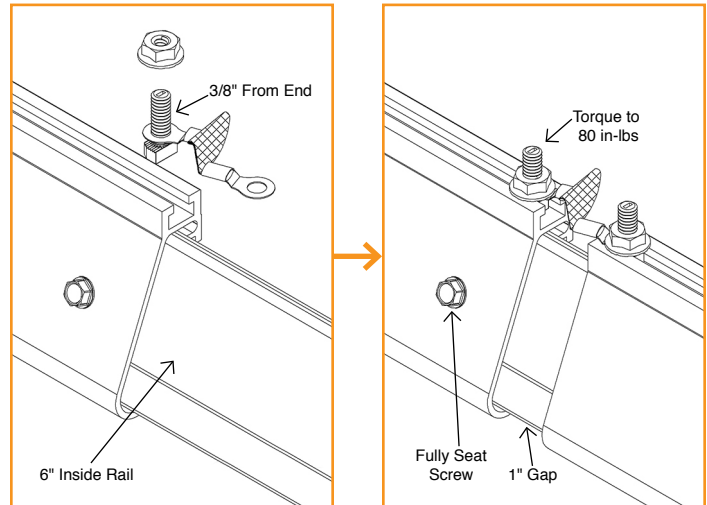

ELECTRICAL DIAGRAM

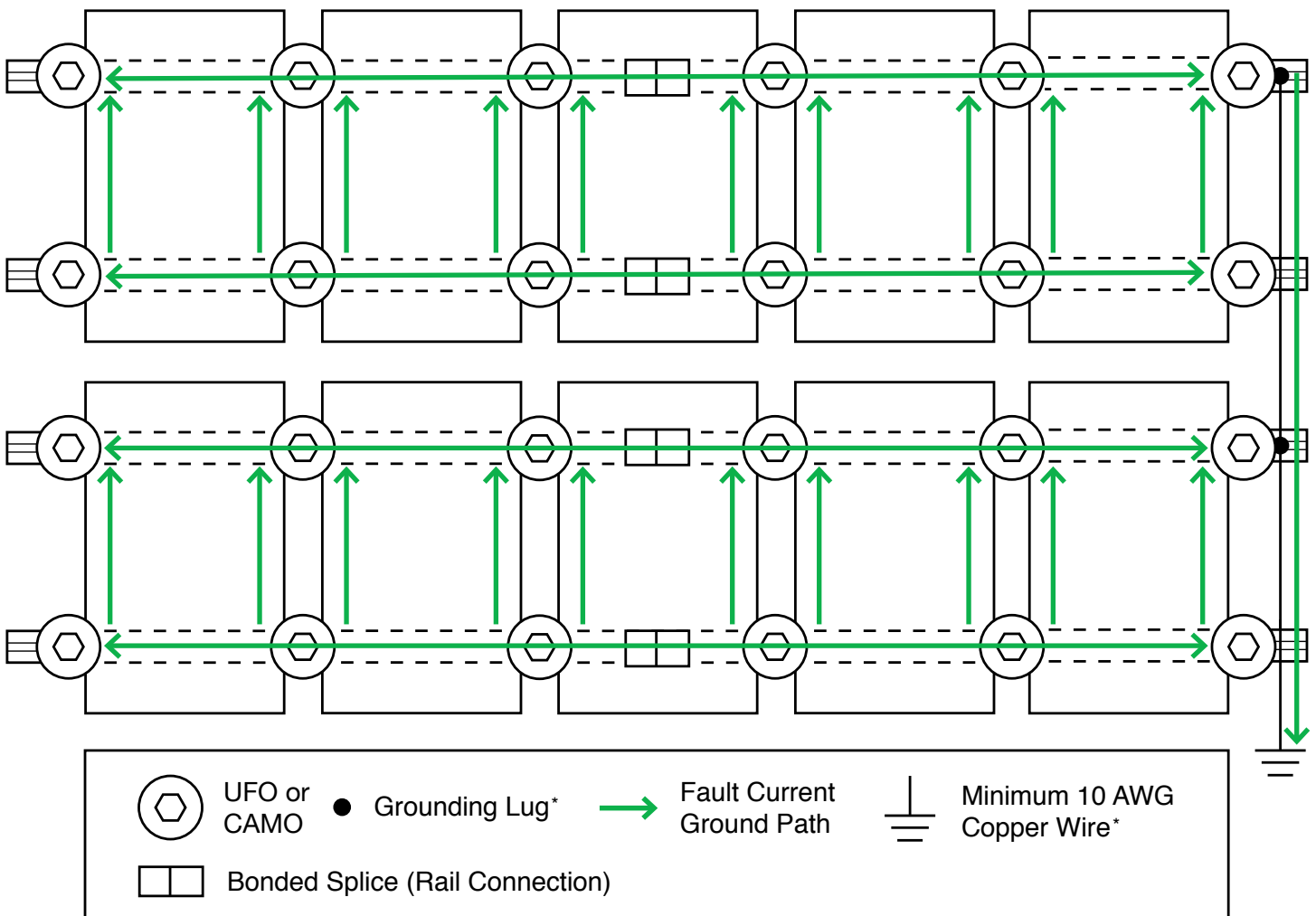

*Grounding Lugs and wire are not required in systems using certain Enphase microinverters or certain Sunpower modules. Equipment grounding is achieved with the Engage cable for Enphase or the AC module cable system for Sunpower via their integrated EGC.

FLASHFOOT2

Locate roof rafters and mark locations on roof. Drill 1/4" pilot holes and backfill with approved sealant. Slide flashing between 1st and 2nd course of shingles, ensuring flashing doesn't overhang the downhill shingle. Line up with pilot hole and insert supplied lag bolt with washer through flashing. Fully seat lag bolt. Place Cap onto flashing in desired orientation for E/W or N/S rails and rotate 180 degrees until it locks into place.

💡 Rail can be installed on either side of FlashFoot2 Cap.

💡 Standalone [FlashFoot2 manual](#) available on website.

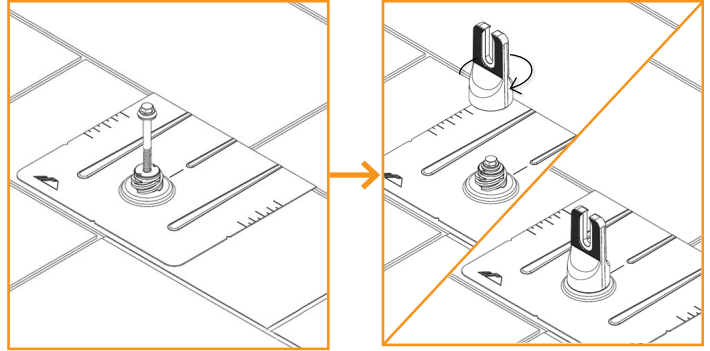

ALL TILE HOOK

Remove tile and mark rafter. Position base over rafter, adjust arm if necessary and torque hardware to **132 in-lbs (11 ft-lbs)**. Use base as guide to drill 1/4" pilot holes, back fill with roofing manufacturer's approved sealant, then insert lag bolts and tighten until fully seated. Replace tiles and notch as necessary to ensure proper fit. Attach rails to either side of slot using bonding hardware and torque to **250 in-lbs (21-ft-lbs)**.

💡 Position arm near the center of valley for curved tiles.

💡 Position arm away from seam of joining flat tiles.

💡 Ensure top of hook does not extend above rail.

💡 IronRidge offers an optional aluminum deck flashing. Refer to [All Tile Hook Flashing Installation Manual](#). Other approved flashing methods include user supplied adhesive backed flexible flashing.

💡 Standalone [All Tile Hook manual](#) available on website.

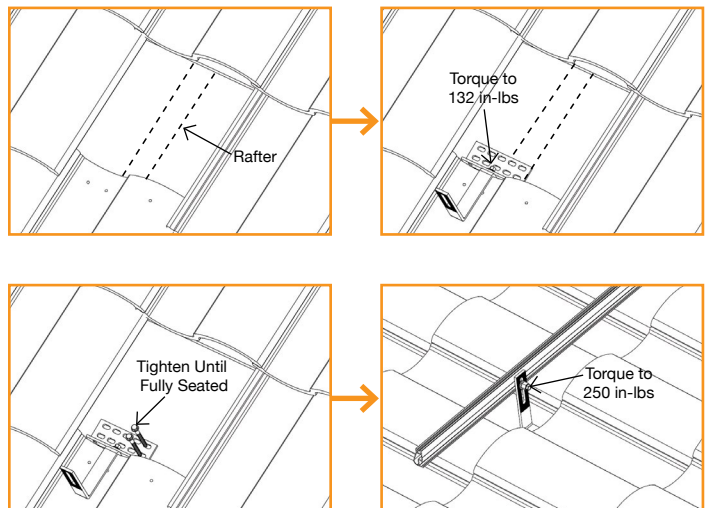

KNOCKOUT TILE

Remove tile and mark rafter. Use base as guide to drill 1/4" pilot hole and fill with roofing manufacturer's approved sealant. Insert lag bolt with bonded washer through base and drive until fully seated. Insert Tile Replacement Flashing, lower onto base and apply pressure over the threaded post until it dimples the flashing. Place L-Foot over dimple and tap with hammer to punch threaded post through the flashing. Ensure punched pieces of flashing are cleared away. Form flashing as needed to sit flush with surrounding tiles, position L-Foot in desired orientation and torque hardware to **132 in-lbs (11 ft-lbs)**. Attach rail to either side of L-Foot with bonding hardware and torque to **250 in-lbs (21 ft-lbs)**.

💡 Base can be installed parallel or perpendicular to rafter.

💡 L-foot can be installed facing any direction.

💡 Ensure L-Foot does not extend above rail.

💡 If deck level flashing is required, approved flashing methods include user supplied adhesive backed flexible flashing.

💡 Standalone [Knockout Tile manual](#) available on website.

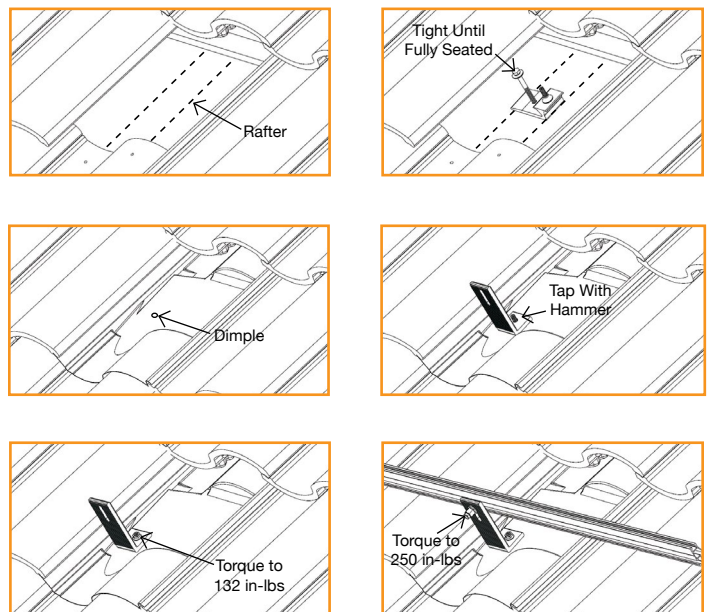

FLAT ROOF ATTACHMENT

Flat Roof Attachment can be used with an L-foot for flush mounting modules on low sloped roofs. Mark locations for Flat Roof Attachment. Screws should be installed symmetrically to each other. If using a membrane flashing, remove the silicone washer's protective liner prior to attaching the membrane. Attach L-foot with washers and 3/8" hardware torqued to **250 in-lbs (21 ft-lbs)**. Seal attachment and/or membrane per roofing manufacturer's requirements.

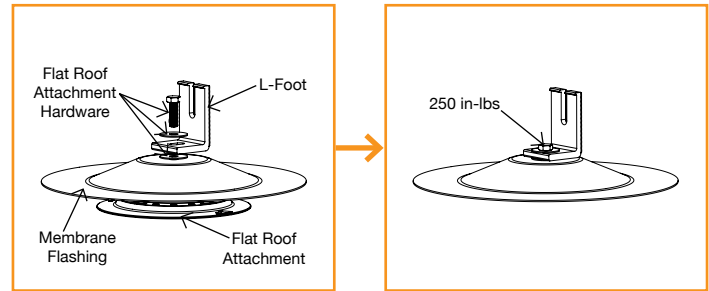

- 💡 Type, size, and quantity of roof screws to be specified by Structural Engineer. Fastener size not to exceed #15.
- 💡 Membrane flashing available for TPO, PVC, and KEE roofs. Ensure membrane flashing is compatible with existing roofing material.
- 💡 If membrane flashing is not used, only washer on top of L-Foot is required.
- 💡 Standalone [Flat Roof Attachment manual](#) available on website.

END CAPS

End Caps add a completed look and keep debris and pests from collecting inside rail.

Firmly press End Cap onto rail end.

- 💡 End Caps come in sets of left and right. Check that the proper amount of each has been provided.

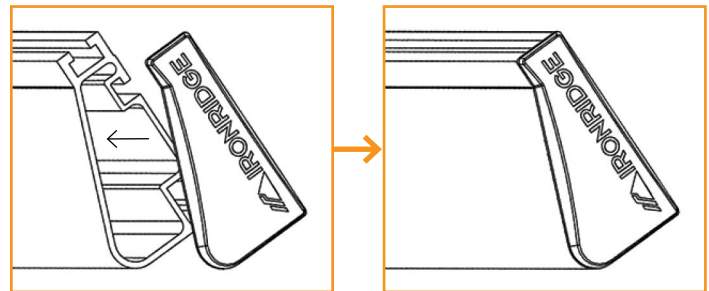

WIRE CLIPS

Wire Clips offer a simple wire management solution.

Firmly press Wire Clip into top rail slot. Run electrical wire through open clip. Snap closed once all wires have been placed.

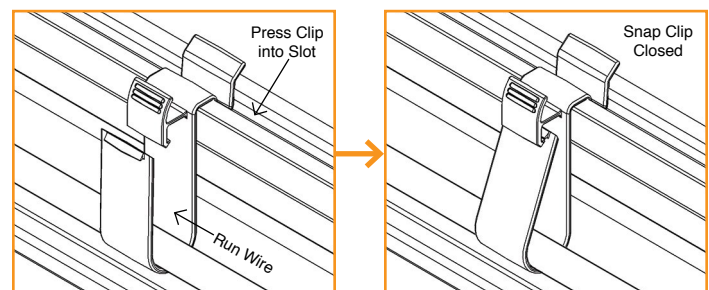

FLUSH STANDOFFS

Attach Standoffs to roof locations with lag bolts (not included). Place flashing over Standoff. Attach L-Foot on Standoff washer with hardware. Torque to **132 in-lbs (11 ft-lbs)**.



MICROINVERTER KITS

Use IronRidge's Microinverter Kit to bond compatible microinverters and power optimizers to the racking system.

Insert Microinverter Kit T-bolt into top rail slot. Place compatible microinverter or power optimizer into position and tighten hex nut to **80 in-lbs**.

💡 If installing in areas with ground snow loads greater than 40 psf, install MLPE devices directly next to module frame edge.

COMPATIBLE PRODUCTS

Enphase

M250-72, 250-60, M215-60, C250-72, S230, S280, IQ 6, IQ 6+, IQ 7, IQ 7+, IQ 7X, Q Aggregator

Darfon

MIG240, MIG300, G320, G640

Solar Edge

P300, P320, P340, P370, P400, P405, P505, P600, P700, P730, P800p, P800s, P850, P860

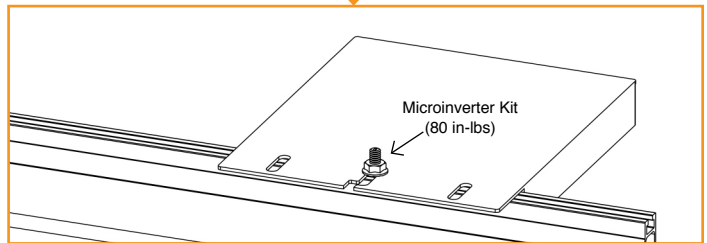
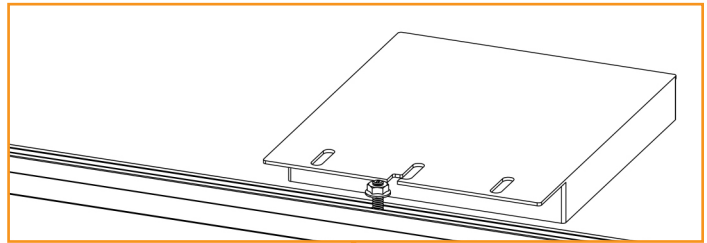

SYSTEMS USING ENPHASE MICROINVERTERS OR SUNPOWER AC MODULES

IronRidge systems using approved Enphase products or SunPower modules eliminate the need for lay-in lugs and field installed equipment grounding conductors (EGC). This solution meets the requirements of UL 2703 for bonding and grounding and is included in this listing.

The following Sunpower modules are included in this listing: Modules with model identifier Ab-xxx-YY and InvisiMount (G5) 46mm frame; where "A" is either E, or X; "b" can be 17, 18, 19, 20, 21, or 22; and "YY" can be C-AC, D-AC, BLK-C-AC, or BLK-D-AC.

The following Enphase products are included in this listing: Microinverters M250-72, M250-60, M215-60, C250-72, and Engage cables ETXX-240, ETXX-208, ETXX-277.

💡 A minimum of two inverters mounted to the same rail and connected to the same Engage cable are required.

💡 The microinverters or Sunpower AC modules must be used with a maximum 20 A branch rated overcurrent protection device (OCPD).

💡 If an AC module is removed from a circuit for maintenance, you must first disconnect AC power and then install a temporary EGC to bridge the gap by inserting an AC extension cable (or via other NEC-compliant means), in order to maintain effective ground continuity to subsequent modules.

SYSTEMS USING PHAZR MICROSTORAGE PRODUCTS

Bonding and grounding is achieved via the IronRidge system when using the Microinverter Kit. Running a separate equipment grounding conductor to the PHAZRs is not required.

💡 If installing in areas with ground snow loads greater than 40 psf and underneath a module, install PHAZR devices as close as possible to module frame edge.

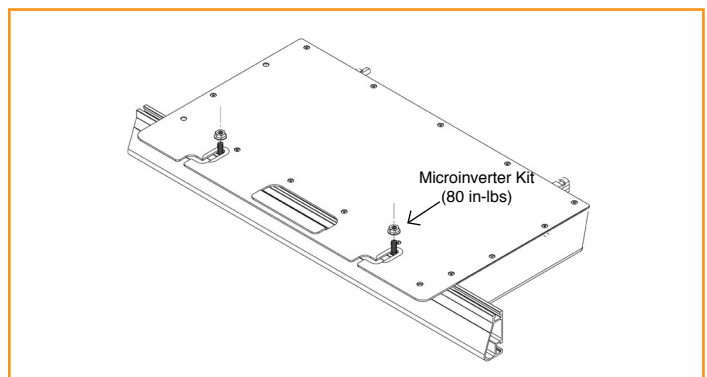

FRAMELESS MODULE KITS

Insert Frameless Kit T-bolt in top rail slot. Place star washer over T-bolt, allowing it to rest on top of rail. Secure module clamps with a hex nut and torque to **80 in-lbs**.

💡 **Tested or evaluated module clamps:**

- Sunforson silver or black SFS-UTMC-200(B) mid and SFS-UTEC-200(B) end clamps.
- Sunpreme silver or black mid and end clamps with part numbers 7500105X where "X" is 1, 5, 6 or 7.
- IronRidge silver or black mid and end clamps with part numbers FMLS-XC-001-Y where "X" is E or M and "Y" is B or blank.

💡 Follow module manufacturer's installation instructions to install the module clamps.

💡 Frameless modules require using a Grounding Lug on every rail.

💡 For Sunpreme Modules Only: If required to use slide prevention hardware, see Module Slide Prevention Addendum (Version 1.10).

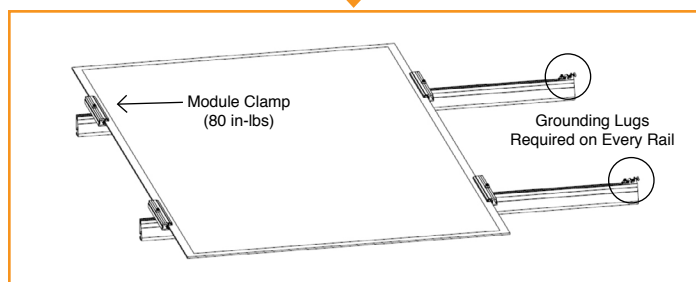
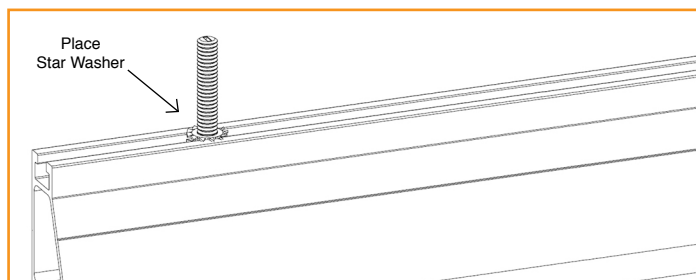

MODULE COMPATIBILITY

The Flush Mount System may be used to ground and/or mount a PV module complying with UL 1703 only when the specific module has been evaluated for grounding and/or mounting in compliance with the included instructions. Unless otherwise noted, "xxx" refers to the module power rating and both black and silver frames are included in the certification.

MAKE	MODELS
Amerisolar	Modules with 35, 40 and 50mm frames and model identifier ASbYxxxZ; where "b" can be 5 or 6; "Y" can be M, P, M27, P27, M30, or P30; and "Z" can be blank, W or WB.
Astronergy Solar	Modules with 35, 40, and 45mm frames and model identifier aaSM66yyPzz-xxx; where "aa" can be CH or A; "yy" can be either 10 or 12; and "zz" can be blank, HV, (BF) or (BL). Frameless modules with model identifier CHSM6610P(DG)-xxx.
Auxin	Modules with 40mm frames and model identifier AXN6y6zAxxx; where "y" can be M or P; "z" can be 08, 09, 10, 11, or 12; and "A" can be F or T.
Axitec	Modules with 35 and 40mm frames and model identifier AC-xxxY/aa-ZZ; where "Y" can be M or P; "aa" can be 125 or 156; and "ZZ" can be 54S, 60S or 72S.
Boviet	Modules with 40mm frames and model identifier BVM66aaYY-xxx; where "aa" can be 9, 10 or 12; and "YY" is M or P.
BYD	Modules with 35mm frames and model identifier BYDxxxAY-ZZ; where "A" can be M6, P6, or PH; "Y" can be C or K; and "ZZ" can be 30 or 36.
Canadian Solar	Modules with 30, 35 and 40mm frames and model identifier CSbY-xxxZ; where "b" can be 1, 3 or 6; "Y" can be H, K, P, U, V, or X; and "Z" can be M, P, MS, PX, M-SD, P-AG, P-SD, MB-AG, PB-AG, MS-AG, or MS-SD. Frameless modules with model identifier CSbY-xxx-Z; where "b" can be 3 or 6; "Y" is K, P, U, or X; and "Z" can be M-FG, MS-FG, P-FG, MB-FG, or PB-FG.
CertainTeed	Modules with 35 and 40mm frames and model identifier CTxxxYZZ-AA; where "Y" can be M or P; "ZZ" can be 00,01, 10, or 11; and "AA" can be 01, 02 or 03.
CSUN	Modules with 35 and 40mm frames and model identifier YYxxx-zzAbb; where "YY" is CSUN or SST; "zz" is blank, 60, or 72; "A" is blank, P or M; and "bb" is blank, BB, BW, or ROOF.
Ecosolargy	Modules with 35, 40, and 50mm frames and model identifier ECOxxxYzZA-bbD; where "Y" can be A, H, S, or T; "zz" can be 125 or 156; "A" can be M or P; "bb" can be 60 or 72; and "D" can be blank or B.
ET Solar	Modules with 35, 40, or 50mm frames and model identifier ET-Y6ZZxxxAA; where "Y" is P, L, or M; "ZZ" is 60 or 72; and "AA" is WB, WW, BB, WBG, WVG, WBAC, WBCO, WWCO, WWBCO or BBAC.

MODULE COMPATIBILITY

Flex	Modules with 35, 40, or 50mm frames and model identifier FXS-xxxYY-ZZ; where "xxx" is the module power rating; "YY" is BB or BC; and "ZZ" is MAA1B, MAA1W, MAB1W, SAA1B, SAA1W, SAC1B, SAC1W, SAD1W, SBA1B, SBA1W, SBC1B, or SBC1W.
GCL	Modules with 35 and 40mm frames and model identifier GCL-a6/YY xxx; where "a" can be M or P; and "YY" can be 60, 72, or 72H.
GigaWatt Solar	Modules with 40mm frames and model identifier GWxxxYY; where "YY" is either PB or MB.
Hansol	Modules with 35 and 40mm frames and model identifier HSxxxYY-zz; where "YY" can be TB, TD, UB or UD; and "zz" can be AN1, AN3, AN4.
Hanwha Solar	Modules with 40, 45, or 50mm frames and model identifier HSLaaP6-YY-1-xxxZ; where "aa" is either 60 or 72; "YY" is PA or PB; and "Z" is blank or B.
Hanwha Q CELLS	Modules with 32, 35, 40, and 42mm frames and model identifier aaYY-ZZ-xxx; where "aa" can be Q. or B.; "YY" can be PLUS, PRO, PEAK, LINE PRO, LINE PLUS, or PEAK DUO; and "ZZ" can be G3, G3.1, G4, G4.1, L-G2, L-G2.3, L-G3, L-G3.1, L-G3y, L-G4, L-G4.2, L-G4y, LG4.2/TAA, BFR-G3, BLK-G3, BFR-G3.1, BLK-G3.1, BFR-G4, BFR-G4.1, BFR G4.3, BLK-G4.1, G4/SC, G4.1/SC, G4.1/TAA, G4.1/MAX, BFR G4.1/TAA, BFR G4.1/MAX, BLK G4.1/TAA, BLK G4.1/SC, EC-G4.4, G5, BLK-G5, L-G5, L-G5.1, L-G5.2, L-G5.2/H, L-G5.3, G6, BLK-G6, L-G6, LG6.1, LG6.2, or LG6.3.
Heliene	Modules with 40mm frames and model identifier YYZZxxx; where "YY" is 36, 60, 72, or 96; and "ZZ" is M, P, or MBLK.
Hyundai	Modules with 35, 40 and 50mm frames and model identifier HiS-YxxxZZ; where "Y" can be M or S; and "ZZ" can be KI, MI, MF, MG, SG, RI, RG(BF), RG(BK), TI, or TG.
Itek	Modules with 40 or 50mm frames and model identifier IT-xxx-YY; where "YY" is blank, HE, or SE, or SE72.
JA Solar	Modules with 35, 40 and 45mm frames and model identifier JAyyzz-bb-xxx/aa; where "yy" can be M, P, M6 or P6; "zz" can be blank, (K), (L), (R), (V), (BK), (FA), (TG), (FA)(R), (L)(BK), (L)(TG), (R)(BK), (R)(TG), (V)(BK), (BK)(TG), or (L)(BK)(TG); "bb" can be 48, 60, 72, 60S01, 60S02, 60S03, 72S01, 72S02, 72S03; and "aa" can be MP, SI, SC, PR, PR/1500V, 3BB, 4BB, 4BB/RE, 4BB/1500V, 5BB.
Jinko	Modules with 35 and 40mm frames and model identifier JKMYxxxZZ-aa; where "Y" can either be blank or S; "ZZ" can be P, PP, M; and "aa" can be blank, 60, 60B, 60H, 60L, 60BL, 60HL, 60HBL, 60-J4, 60B-J4, 60B-EP, 60(Plus), 60-V, 60-MX, 72, 72-V, 72H-V, 72L-V, 72HL-V or 72-MX. Frameless modules with model identifier JKMxxxPP-DV.
Kyocera	Modules with 46mm frames and model identifier KYxxxZZ-AA; where "Y" is D or U; "ZZ" is blank, GX, or SX; and "AA" is LPU, LFU, UPU, LPS, LPB, LFB, LFBs, LFB2, LPB2, 3AC, 3BC, 3FC, 4AC, 4BC, 4FC, 4UC, 5AC, 5BC, 5FC, 5UC, 6BC, 6FC, 8BC, 6MCA, or 6MPA.
LG	Modules with 35, 40, and 46mm frames LGxxxYaZ-bb; where "Y" can be A, E, N, Q, S; "a" can be 1 or 2; "Z" can be C, K, T, or W; and "bb" can be A3, A5, B3, G3, G4, K4, or V5.
Longi	Modules with 40 and 45mm frames and model identifier LR6-YYZZ-xxxM; where "YY" can be 60 or 72; and "ZZ" can be BK, BP, HV, PB, PE, or PH.
Mission Solar	Modules with 40mm frames and model identifier MSeXXXZZaa; where "ZZ" can be MM, SE, SO or SQ; and "aa" can be 1J, 4J, 4S, 5K, 5T, 6J, 6S, 6W, 8K, 8T, or 9S.
Mitsubishi	Modules with 46mm frames and model identifier PV-MYYxxxZZ; where "YY" is LE or JE; and "ZZ" is either HD, HD2, or FB.
Motech	IM and XS series modules with 40, 45, or 50mm frames.
Neo Solar Power	Modules with 35mm frames and model identifier D6YxxxZZaa; where "Y" can be M or P; "ZZ" can be B3A, B4A, E3A, E4A, H3A, H4A; and "aa" can be blank, (TF), ME or ME (TF).
Panasonic	Modules with 35 and 40mm frames and model identifier VBHNxxxYYzzA; where "YY" can be either SA or KA; "zz" can be either 01, 02, 03, 04, 06, 06B, 11, 11B, 15, 15B, 16, 16B, 17, or 18; and "A" can be blank, E or G.
Peimar	Modules with 40mm frames and model identifier SGxxxYzz; where "Y" can be M or P; and "zz" can be blank, (BF), or (FB).
Phono Solar	Modules with 35, 40, or 45mm frames and model identifier PSxxxY-ZZ/A; where "Y" is M or P; "ZZ" is 20 or 24; and "A" is F, T or U.

MODULE COMPATIBILITY

Prism Solar	Frameless modules with model identifier BiYY-xxxBSTC; where "YY" can be 48, 60, 60S, 72 or 72S.
REC Solar	Modules with 30, 38 and 45mm frames and model identifier RECxxxYYZZ; where "YY" can be M, NP, PE, TP, TP2, TP2M, TP2SM, or TP2S; and "ZZ" can be blank, Black, BLK, BLK2, SLV, or 72.
Renesola	Modules with 35, 40 or 50mm frames and model identifier JCxxxY-ZZ; where "Y" is F, M or S; and "ZZ" is Ab, Ab-b, Abh, Abh-b, Abv, Abv-b, Bb, Bb-b, Bbh, Bbh-b, Bbv, Bbv-b, Db, or Db-b.
Renogy	Modules with 40 or 50mm frames and model identifier RNG-xxxY; where "Y" is D or P.
S-Energy	Modules with 40mm frames and model identifier SNxxxY-ZZ; where "Y" is M or P; and "ZZ" is 10, or 15.
Seraphim Energy Group	Modules with 40mm frames and model identifier SEG-6YY-xxxZZ; where "YY" can be MA, MB, PA, PB; and "ZZ" can be BB, WB, or WW.
Seraphim USA	Modules with 40 and 50mm frames and model identifier SRP-xxx-6YY; where "YY" can be MA, MB, PA, PB, QA-XX-XX, and QB-XX-XX.
Sharp	Modules with 35 or 40mm frames and model identifier NUYYxxx; where "YY" is SA or SC.
Silfab	Modules with 38mm frames and model identifier SYY-Z-xxx; where "YY" is SA or LA; SG or LG; and "Z" is M, P, or X.
Solaria	Modules with 40mm frames and model identifier PowerXT xxxY-ZZ; where "Y" can be R or C; and "ZZ" can be AC, BD, BX, BY, PD, PX, PZ, WX or WZ.
SolarTech	Modules with 42mm frames and model identifier STU-xxxYY; where "YY" can be PERC or HJT.
SolarWorld AG / Industries GmbH	SolarWorld Sunmodule Plus, Protect, Bisun, XL, Bisun XL, may be followed by mono, poly, duo, black, bk, or clear; modules with 31, 33 or 46mm frames and model identifier SW-xxx.
SolarWorld Americas Inc.	SolarWorld Sunmodule Plus, Protect, Bisun, XL, Bisun XL, may be followed by mono, poly, duo, black, bk, or clear; modules with 33mm frames and model identifier SWA-xxx.
Stion	Thin film modules with 35mm frames and model identifier STO-xxx or STO-xxxA. Thin film frameless modules with model identifier STL-xxx or STL-xxxA.
SunEdison	Modules with 35, 40, or 50mm frames and model identifier SE-YxxxZABCDE; where "Y" is B, F, H, P, R, or Z; "Z" is 0 or 4; "A" is B, C, D, E, H, I, J, K, L, M, or N; "B" is B or W; "C" is A or C; "D" is 3, 7, 8, or 9; and "E" is 0, 1 or 2.
Suniva	Modules with 35, 38, 40, 46, or 50mm frames and model identifiers OPTxxx-AA-B-YYY-Z or MVXxxx-AA-B-YYY-Z; where "AA" is either 60 or 72; "B" is either 4 or 5; "YYY" is either 100,101,700,1B0, or 1B1; and "Z" is blank or B.
Sunpower	Modules with standard (G3 or G4) or InvisiMount (G5) 40 and 46mm frames with model identifier SPR-Zb-xxx-YY; where "Z" is either A, E, P or X; "b" can be blank, 17, 18, 19, 20, 21, or 22; and "YY" can be blank, NE, BLK, COM, C-AC, D-AC, E-AC, BLK-C-AC, or BLK-D-AC.
Sunpreme	Sunpreme modules with 35 and 40mm frames and model identifier SNPM-AxB-xxxYzz; where "A" can be G or H; "Y" can be blank or T; and "zz" can be blank, 4BB, SM or 4BB SM. Frameless modules with model identifier SNPM-GxB-xxxZZ; where "ZZ" can be blank, 4BB, SM or 4BB SM.
Sunspark	Modules with 40mm frames and model identifier SYY-xxZ; where "YY" can be MX or ST; and "Z" can be P or W.
Suntech	Vd, Vem, Wdb, Wde, and Wd series modules with 35, 40, or 50mm frames.
Talesun	Modules with 35 and 40mm frames and model identifier TP6yyZxxx-A; where "yy" can be 60, 72, H60 or H72; "Z" can be M, or P; and "A" can be blank, B, or T.
Trina	Modules with 35, 40 or 46mm frames and model identifier TSM-xxxYYZZ; where "YY" is PA05, PC05, PD05, PA14, PC14, PD14, PE14, or DD05; and "ZZ" is blank, A, A.05, A.08, A.10, A.18, .05, .08, .10, .18, .08D, .18D, 0.82, A.082(II), .002, .00S, 05S, 08S, A(II), A.08(II), A.05(II), A.10(II), or A.18(II). Frameless modules with model identifier TSM-xxxYY; and "YY" is either PEG5, PEG5.07, PEG14, DEG5(II), DEG5.07(II), or DEG14(II).
Winaico	Modules with 35 or 40mm frames and model identifier Wsy-xxxz6; where "y" is either P or T; and "z" is either M or P.
Yingli	Panda, YGE, and YGE-U series modules with 35, 40, or 50 mm frames.

17721 SS

17664, 17720

LOW PROFILE QUICKBOLT WITH 4" MICROFLASHING®
FOR ASPHALT SHINGLE ROOFS
PATENT # 8448407

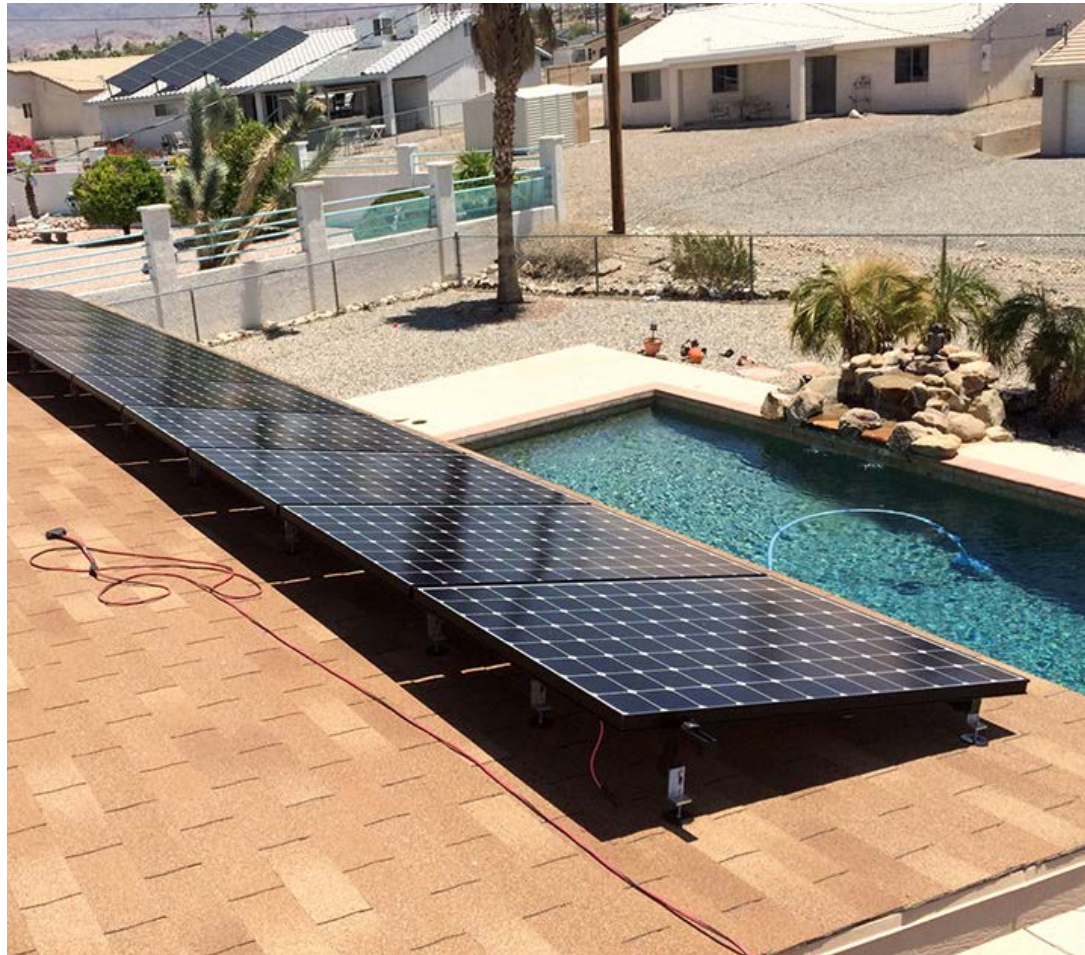

TABLE OF CONTENTS

3

SPEC SHEET

QTY & MEASUREMENT INFORMATION

6

INSTALLATION INSTRUCTIONS

STEP-BY-STEP-INSTALLATION GUIDE

7

ENGINEERING REPORT

UPLIFT & LATERAL LOAD TEST

12

UL CERTIFICATION

PROOF OF UL CERTIFICATION

SPEC SHEET

Part #	Box Quantity
17664	5.25" Bolts (10)
17720	4" Microflashing® (10); 5.25" Bolts (10)
17721 SS	4" Microflashing® (20); 5.25" Bolts (20); L-Foot (20); 5/16" Serrated Hex Flange Nuts (20)



Part #17664

5/16-18 X 5.25"
304 Stainless Steel
Removable Hanger Bolts

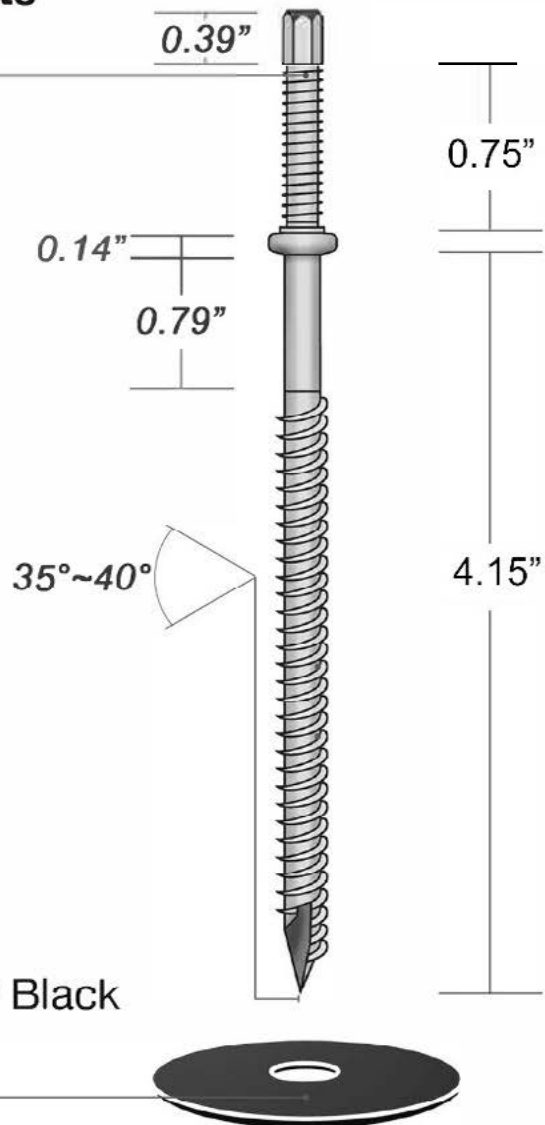

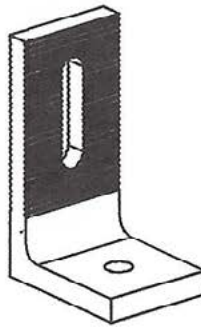
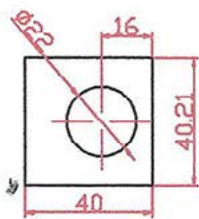
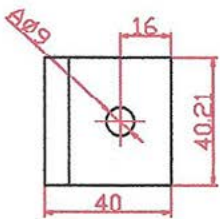
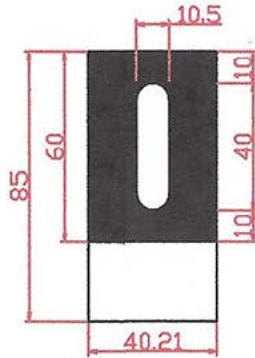
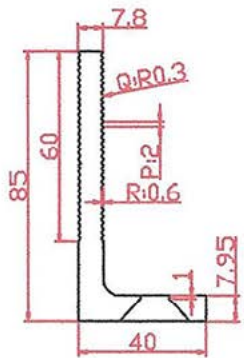

Baiting tolerance	± 2 mm
Hole tolerance	± 0.5 mm
Hole distance tolerance	± 0.5 mm
Form tolerance	± 2 mm
Thickness tolerance	± 0.1 mm
Angle tolerance	$\pm 1^\circ$ mm

INSTALL INSTRUCTIONS



RECOMMENDED MATERIALS

- Rafter locator
- Chalk or a crayon
- Drill with a 3/16" drill bit
- MFG approved sealant
- M6 deep socket hex driver
- 1/2" wrench

INSTALLATION INSTRUCTIONS

1. Locate the rafter and predrill the hole
2. Fill the predrilled hole with MFG approved sealant
3. Place a ring of sealant around the bottom of the Microflashing® washer
4. Place the Microflashing® and drive the bolt until it compresses
5. Insert the L-Foot
6. Insert the nut and tighten until secure



BUILDING CODE LETTER



February 26, 2019

To whom this may concern,

QuickBOLT is committed to excellence. The parts tested are durable goods, meaning the material composition and detailed specifications of the parts do not change. Therefore, all stamps are current. Any part tested will have the same results no matter what year the tests are performed.

SolarRoofHook is the previous name of QuickBOLT. Any test result referencing SolarRoofHook is referring to a QuickBOLT product.

All our parts were tested by a third-party test facility, in possession of a current engineering license for the state where the tests were performed for the following.

1. Uplift test
2. Downward load test
3. Lateral Test – Asphalt Mounts, and Metal Mounts only
4. ASTM E2440 and ASTM E330 Waterproof Tests - QuickBOLT only

The following is an excerpt from:

CALIFORNIA BOARD FOR PROFESSIONAL ENGINEERS AND LAND SURVEYORS
guide to Engineering & Land Surveying for City and County Officials
Page 12, Line 27

27. If the license has expired between the time the engineering documents were prepared and the time when the local agency's review is performed, do the documents need to be re-sealed by a licensee with a current license? (B&P Code §§ 6733, 6735, 6735.3, 6735.4)

As long as the license was current at the time the engineering documents were prepared, the documents do not need to be re-sealed prior to review by the local agency. However, any changes (updates or modifications) to the documents that are made following the review by the local agency would have to be prepared by a licensed engineer with a current license and those changes would have to be signed and sealed.

We trust the information provided will resolve any request for the test reports submitted to have a stamp from the current year.

Regards,

Rick Gentry
Executive Vice President

ENGINEERING REPORT



APPLIED MATERIALS & ENGINEERING, INC.

980 41st Street
Oakland, CA 94608

Tel: (510) 420-8190
FAX: (510) 420-8186
e-mail: info@appmateng.com

February 14, 2018

Mr. Rick Gentry
SolarRoofHook
a division of Quickscrews International Corp.
5830 Las Positas Road
Livermore, CA 94551

Project Number 1180031C

Subject: L-Foot 4mm w/ Low Profile 5-1/4" QuickBOLT
Part #15894SS with Part #17664 Laboratory Load Testing

Dear Mr. Gentry:

As requested, Applied Materials & Engineering, Inc. (AME) has completed load-testing the L-Foot 4mm (Part #15894SS) with the Low Profile 5-1/4" QuickBOLT (Part #17664); see Appendix A, Figure A1 and Figure A2, respectively. The purpose of our testing was to evaluate the lateral and tensile (uplift) load capacity of the L-Foot 4mm connecting member attached to a 2"x4" Douglas Fir rafter using one Low Profile 5/16"Øx5-1/4" QuickBOLT.

SAMPLE DESCRIPTION

Mockup samples were delivered to our laboratory on January 10, 2018. Mockup configuration consisted of three 12" long rafters at 6.5" o.c., screwed to 1/2" OSB. One 5/16"Øx5-1/4" QuickBOLT was screwed through the Microflashing™ (sold as Part #17669) and then through the OSB into a rafter. The L-Foot 4mm is fastened to the QuickBOLT using one 5/16" 18-8 Stainless Steel Flange Nut.

TEST PROCEDURES & RESULTS

1. Lateral Load Test

A total of three tests were conducted for lateral load capacity on January 12, 2018 using a United Universal testing machine. Samples were rigidly attached to the testing machine and a lateral load was applied to each L-foot. The samples were loaded in shear at a constant rate of axial deformation of 0.10 in. /min. without shock until failure occurred; displacement at maximum load was recorded. Based on the above testing, the average maximum lateral load of the L-Foot 4mm attached to a 2"x4" Douglas Fir rafter using one Low Profile 5/16"Øx5-1/4" QuickBOLT was determined to be 508 lbf. Detailed results are provided in Table I and Figure 1. Test setup and mode of failure are provided in Appendix B, Figure B1.

The specific gravity and moisture content of each rafter was tested in accordance with ASTM D2395, Method A (oven-dry). The average specific gravity and average moisture content of the three samples were determined to be 0.416 and 10.8%, respectively.

Mr. Rick Gentry
SolarRoofHook
L-Foot 4mm w/ Low Profile 5-1/4" QuickBOLT
Part #15894SS with Part #17664 Laboratory Load Testing
February 14, 2018

Project Number 1180031C

2. Tensile (Uplift) Load Test

A total of three tests were conducted for tensile (uplift) load capacity on January 16, 2018 using a United Universal testing machine. Samples were rigidly attached to the testing machine and an uplift (tensile) load was applied to each L-foot. The samples were loaded in tension at a constant rate of axial deformation of 0.10 in. /min. without shock until failure occurred; displacement at maximum load was recorded. Based on the above testing, the average maximum uplift load of the L-Foot 4mm attached to a 2"x4" Douglas Fir rafter using one Low Profile 5/16"Øx5-1/4" QuickBOLT was determined to be 3277 lbf. Detailed results are provided in Table II and Figure 2. Test setup and mode of failure are provided in Appendix B, Figure B2.

The specific gravity and moisture content of the rafter was tested in accordance with ASTM D2395, Method A (oven-dry). The average specific gravity and average moisture content of the three samples were determined to be 0.402 and 11.1%, respectively.

Respectfully Submitted,

APPLIED MATERIALS & ENGINEERING, INC.

Joseph Gapuz

Joseph Gapuz
Laboratory Manager

Reviewed by:



Armen Tajirian
Armen Tajirian, Ph.D., P.E.
Principal

TABLE I

LATERAL LOAD TEST RESULTS

L-FOOT 4MM

PART #15894SS w/ LOW PROFILE 5/16"Øx5-1/4" QUICKBOLT (PART #17664)

PROJECT NUMBER 1180031C

TEST NUMBER	MAXIMUM LATERAL LOAD (lbf)	DISPLACEMENT AT MAXIMUM LOAD (in.)	MODE OF FAILURE	RAFTER SPECIFIC GRAVITY	RAFTER MOISTURE CONTENT (%)
999	552	3.5	Test Fixture Contacted Plywood	0.398	10.9
1000	498	3.5		0.413	11.7
1001	475	3.5		0.438	9.7
AVERAGE	508	3.5	..	0.416	10.8

FIGURE 1

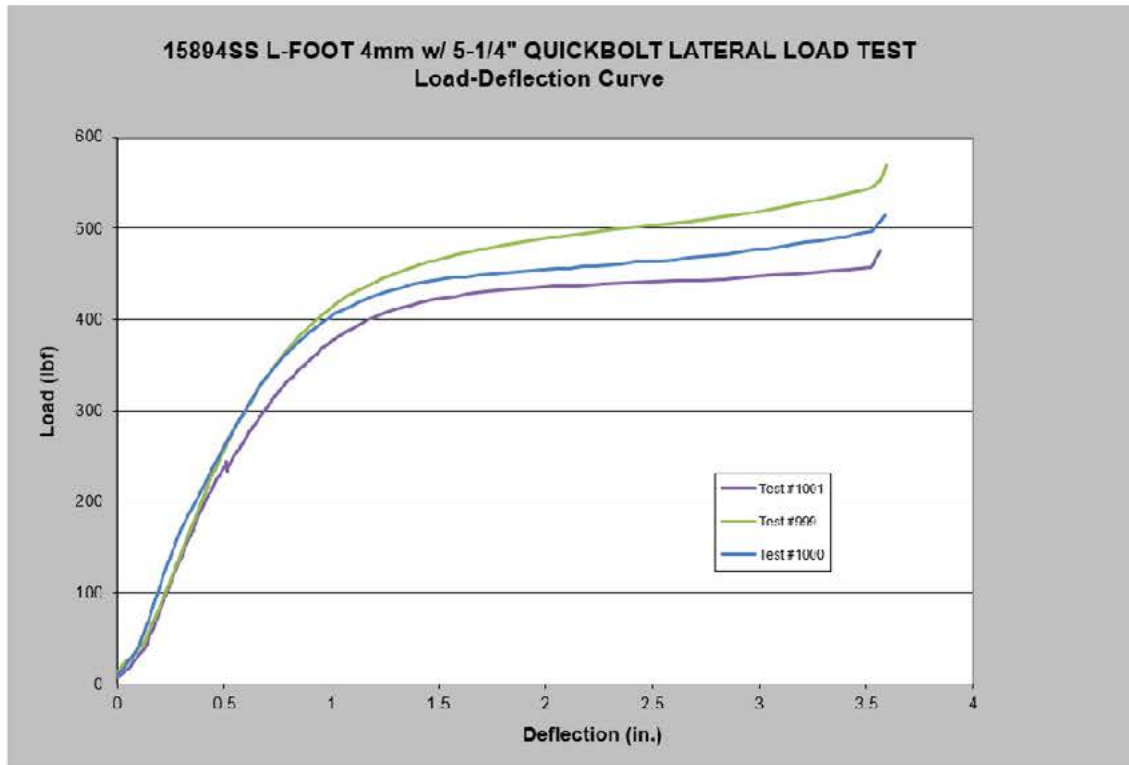

Note: Maximum load recorded at moment fixture contacts plywood; see Appendix B for image of failure mode.

TABLE II

TENSILE (UPLIFT) LOAD TEST RESULTS

L-FOOT 4MM

PART #15894SS w/ LOW PROFILE 5/16"Øx5-1/4" QUICKBOLT (PART #17664)

PROJECT NUMBER 1180031C

TEST NUMBER	MAXIMUM TENSILE LOAD (lbf)	DISPLACEMENT AT MAXIMUM LOAD (in.)	MODE OF FAILURE	RAFTER SPECIFIC GRAVITY	RAFTER MOISTURE CONTENT (%)
914	3397	0.8	QuickBOLT Pull-out	0.395	10.1
918	3191	0.8		0.431	11.5
919	3242	0.8		0.381	11.9
AVERAGE	3277	0.8	..	0.402	11.1

FIGURE 2

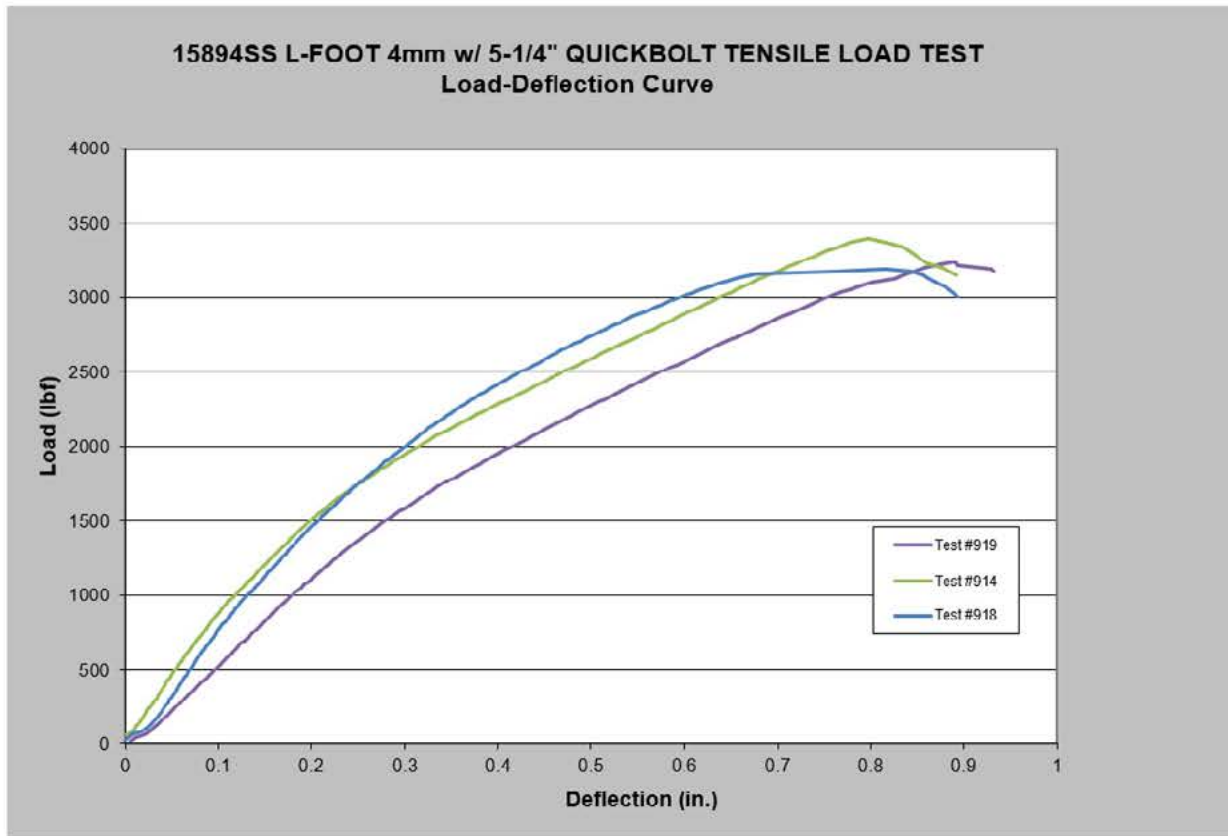

CERTIFICATE OF COMPLIANCE

Certificate Number 20180725-E493748
Report Reference E493748-20170817
Issue Date 2018-JULY-25

Issued to: SolarRoofHook, a Division of Quickscrews International Corp
5830 Las Positas Rd, Livermore CA 94551

**This is to certify that
representative samples of**

COMPONENT - MOUNTING SYSTEMS, MOUNTING DEVICES,
CLAMPING DEVICES AND GROUND LUGS FOR USE WITH
PHOTOVOLTAIC MODULES AND PANELS
Refer to Addendum Page for Models/Product.

Have been investigated by UL in accordance with the
Standard(s) indicated on this Certificate.

Standard(s) for Safety: UL 2703 Standard for Mounting Systems, Mounting
Devices, Clamping/Retention Devices, and Ground Lugs for
Use with Flat-Plate Photovoltaic Modules and Panels.

Additional Information: See the UL Online Certifications Directory at
www.ul.com/database for additional information

Only those products bearing the UL Certification Mark should be considered as being covered by UL's
Certification and Follow-Up Service.

The UL Recognized Component Mark generally consists of the manufacturer's identification and catalog
number, model number or other product designation as specified under "Marking" for the particular
Recognition as published in the appropriate UL Directory. As a supplementary means of identifying products
that have been produced under UL's Component Recognition Program, UL's Recognized Component Mark:
 may be used in conjunction with the required Recognized Marks. The Recognized Component Mark is
required when specified in the UL Directory preceding the recognitions or under "Markings" for the individual
recognitions.

Recognized components are incomplete in certain constructional features or restricted in performance
capabilities and are intended for use as components of complete equipment submitted for investigation rather
than for direct separate installation in the field. The final acceptance of the component is dependent upon its
installation and use in complete equipment submitted to UL LLC.

Look for the UL Certification Mark on the product.



Bruce Mahrenholz, Director North American Certification Program
UL LLC

Any information and documentation involving UL Mark services are provided on behalf of UL LLC (UL) or any authorized licensee of UL. For questions, please
contact a local UL Customer Service Representative at <http://ul.com/about/locations/>



CERTIFICATE OF COMPLIANCE

Certificate Number 20180725-E493748
Report Reference E493748-20170817
Issue Date 2018-JULY-25

This is to certify that representative samples of the product as specified on this certificate were tested according to the current UL requirements.

Models/Product

USR – Component, Roof Mounting Hook Units, Models 15891 15893 15987 16000 16988 16990
16991 16993 17508 17509 17510 17511 17512 17513 17514 17515 17516 17517 17518 17519 17520
17521 17522 17523 17524 17525 17526 17527 17536 17537 17538 17539 17540 17541 17542 17543
17544 17545 17546 17547 17548 17549 17550 17551 17552 17553 17554 17555 17556 17558 17559
17560 17568 17569 17570 17571 17572 17573 17574 17575 17576 17577 17578 17579 17580 17585
17586 17587 17588 17589 17592 17596 17600 17601 17606 17607 17608 17609 17610 17611 17612
17613 17614 17615 17616 17617 17618 17620 17621 17622 17623 17624 17625 17626 17627 17628
17629 17630 17631 17632 17633 17636 17637 17638 17639 17642 17643 17646 17647 17648 17649
17650 17651 17659 17664 17667 17669 17670 17671 17672 17673 17678 17679 17680 17681 17686
17687 17688 17689 17700 17701 17702 17703 17704 17705 17706 17707 17708 17709 17710 17711
17712 17717 17718 17759 15891-10 15891BLK-10 15987A 15987B 17667SS 17672SS 17680SS
17688SS 17713SS 17720 17721SS 17723 17724SS 17726 17727SS 17729 17730SS 15894SS
15891SS 15987BSS.

B. Mahrenholz

Druce Mahrenholz, Director North American Certification Program

UL LLC

Any information and documentation involving UL Mark services are provided on behalf of UL LLC (UL) or any authorized licensee of UL. For questions, please contact a local UL Customer Service Representative at <http://ul.com/about/locations/>



“Stay Connected” with



Solar Power Components

a PennEngineering® Company



Heyco® SunScreener® Wire Mesh Clip

- Helps protect solar panels from rodents and nesting birds with wire mesh screening (screening not included). See Heyco Sunscreen below.
- Constructed from 303 and 304 Stainless Steel for maximum endurance to outdoor elements.
- 303 Stainless Steel J-Hook easily attaches to the solar panel frames and can easily be trimmed or bent after assembly.
- 304 Stainless Steel Washers will firmly hold wire mesh screen to the module assembly preventing squirrels and rodents from damaging the interconnection wires and birds from building nests under the solar panel.
- Does not violate panel integrity.
- Installs quickly and easily with standard linesman pliers
- Black color available for those applications subject to **HOA appearance restrictions**.
- Stainless Steel Washers are offered in both steel color and black painted versions.
- Not for use in a marine salt water environment. Contact Heyco for alternative materials.
- DFARS Compliant

PART NO.		PART DIMENSIONS									
Steel Gray	Black	A		B		C		D		E	
		Overall Length		Diameter		Width		Height		Washer Diameter	
		in.	mm.	in.	mm.	in.	mm.	in.	mm.	in.	mm.
Stainless Steel											
S6437	S6438	4.87	124,0	.08	2,0	.38	9,7	.38	9,7	1.00	25,4

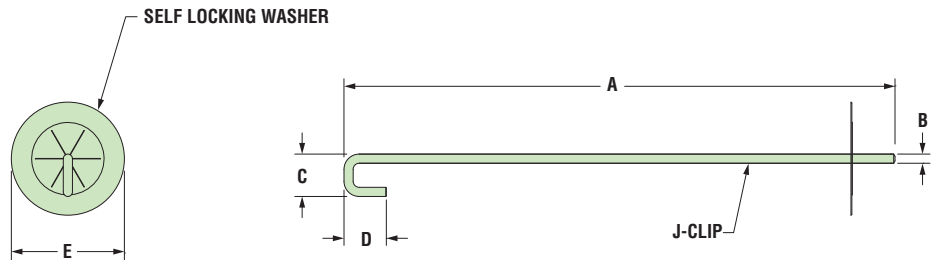

Heyco® SunScreen®

Wire Mesh - For use with Heyco SunScreener Clips

PART NO.	PART DIMENSIONS	
	Black	Length
	Width	feet
	in.	
S6464	4	100´
S6466	6	Rolls
S6468	8	Rolls

- Mesh dimension is 1/2" x 1/2".
- DFARS Compliant
- For SunScreener Clips and SunScreen Mesh bundled in **Kit** form, see page 1-33.

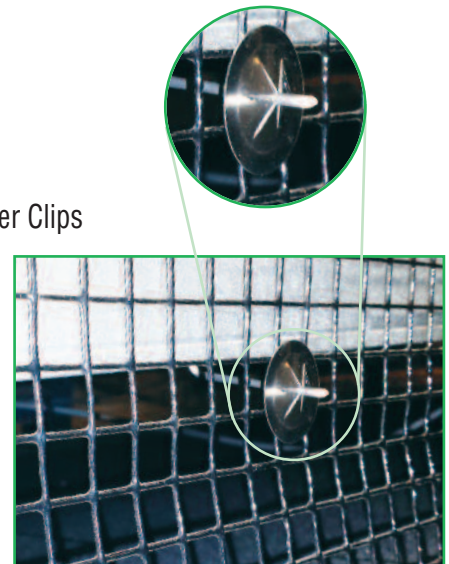

Quick Specs

Material SunScreener Wire Mesh Clip
 J-Hook 303 Stainless steel
 Washer 304 Stainless steel

SunScreen Wire Mesh
 PVC Coated, galvanized welded steel mesh