



Scott E. Wyssling, PE  
Jon P. Ward, SE, PE  
Gregory T. Elvestad, PE

76 North Meadowbrook Drive  
Alpine, UT 84004  
office (201) 874-3483  
swyssling@wysslingconsulting.com

July 8, 2022

Sustainable Energy and Lighting Solutions  
8351 Palmetto Commerce Parkway, Ste. 203  
Ladson, SC 29456

Scott  
Wyssling,  
PE

Digitally signed by Scott Wyssling, PE  
DN: C=US, S=Utah, L=Alpine,  
O=Wyssling Consulting,  
OU=Engineering, CN="Scott  
Wyssling, PE",  
E=swyssling@wysslingconsulting.com  
Reason: I am the author of this  
document  
Location: your signing location here  
Date: 2022.07.08 11:34:46-06'00'  
Foxit PDF Editor Version: 11.1.0

Re: Engineering Services  
Skatell Residence  
1565 Chicora Road, Dunn, NC  
17.380 kW System

To Whom It May Concern:

We have received information regarding solar panel installation on the roof of the above referenced structure. Our evaluation of the structure is to verify the existing capacity of the roof system and its ability to support the additional loads imposed by the proposed solar system.

#### A. Site Assessment Information

1. Site visit documentation identifying attic information including size and spacing of framing for the existing roof structure.
2. Design drawings of the proposed system including a site plan, roof plan and connection details for the solar panels. This information will be utilized for approval and construction of the proposed system.

#### B. Description of Structure:

**Roof Framing:** 2x6 dimensional lumber at 24" on center.  
**Roof Material:** Metal Roofing  
**Roof Slope:** 22.6 degrees  
**Attic Access:** Accessible  
**Foundation:** Permanent

#### C. Loading Criteria Used

- **Dead Load**
  - Existing Roofing and framing = 7 psf
  - New Solar Panels and Racking = 3 psf
  - TOTAL = 10 PSF
- **Live Load** = 20 psf (reducible) – 0 psf at locations of solar panels
- **Ground Snow Load** = 15 psf
- **Wind Load** based on ASCE 7-10
  - Ultimate Wind Speed = 115 mph (based on Risk Category II)
  - Exposure Category C

*Analysis performed of the existing roof structure utilizing the above loading criteria is in accordance with the 2018 NCRC, including provisions allowing existing structures to not require strengthening if the new loads do not exceed existing design loads by 105% for gravity elements and 110% for seismic elements. This analysis indicates that the existing framing will support the additional panel loading without damage, if installed correctly.*

**D. Solar Panel Anchorage**

1. The solar panels shall be mounted in accordance with the most recent S-5! Installation Manual. If during solar panel installation, the roof framing members appear unstable or deflect non-uniformly, our office should be notified before proceeding with the installation.
2. System will be attached to the metal roofing material utilizing the patented S-5 connection. Installation of the connections shall be in accordance with the manufacturer's recommendations.
3. Considering the roof slopes, the size, spacing, condition of roof, the panel supports shall be placed no greater than 48" o/c.
4. Connection on the roof is utilizing (4) 1/2" or #14 screws into the existing decking to resist uplift forces. Contractor to verify installation to be performed in accordance with the Unirac recommendations. Pull out values per screw are based on National Design Specification values for CDX plywood and are identified as 208 lbs/inch. Based on 1/2" sheathing the value per screw would be 104 lbs providing 416 lbs uplift resistance per attachment.

Based on the above evaluation, this office certifies that with the racking and mounting specified, the existing roof system will adequately support the additional loading imposed by the solar system. This evaluation is in conformance with the 2018 NCRC, current industry standards, and is based on information supplied to us at the time of this report.

Should you have any questions regarding the above or if you require further information do not hesitate to contact me.

Very truly yours,

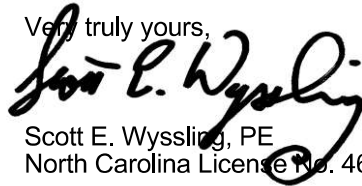

Scott E. Wyssling, PE  
North Carolina License No. 46546



Wyssling Consulting, PLLC  
76 N Meadowbrook Drive Alpine UT 84004  
North Carolina COA # P-2308

Signed 7/8/2022

**THIS PLAN HAS BEEN ELECTRONICALLY SIGNED AND SEALED BY SCOTT WYSSLING, PE USING A DIGITAL SIGNATURE AND DATE. PRINTED COPIES OF THIS DOCUMENT ARE NOT CONSIDERED SIGNED AND SEALED AND THE SIGNATURE MUST BE VERIFIED ON ANY ELECTRONIC COPIES**

Scott  
Wyssling, PE

Digitally signed by Scott Wyssling, PE  
DN: C=US, S=Utah, L=Alpine, O=Wyssling Consulting, OU=Engineering, CN="Scott Wyssling, PE", E=swyssling@wysslingconsulting.com  
Reason: I am the author of this document  
Location: your signing location here  
Date: 2022.07.08 11:34:56-06'00'  
Foxit PDF Editor Version: 11.1.0

# NICK SKATELL - 17.380KW DC, 12.760KW AC, 21.000KWH STORAGE SYSTEM

## SITE PLAN

NOTE: CONDUIT RUN IS IN ATTIC

Digitally signed by Scott Wyssling, PE  
 DN: cn=Scott Wyssling, o=Wyssling Consulting, ou=Engineering, c=US  
 Date: 2022.07.08 11:55:06-06'00'  
 I am the author of this document  
 Location: your signing location

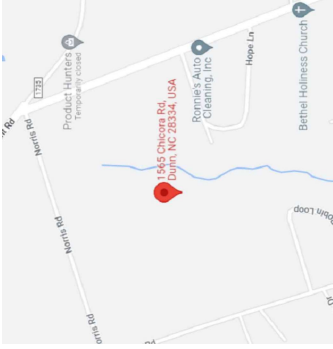

A1 VICINITY MAP  
 PV-1.0 SCALE: NTS

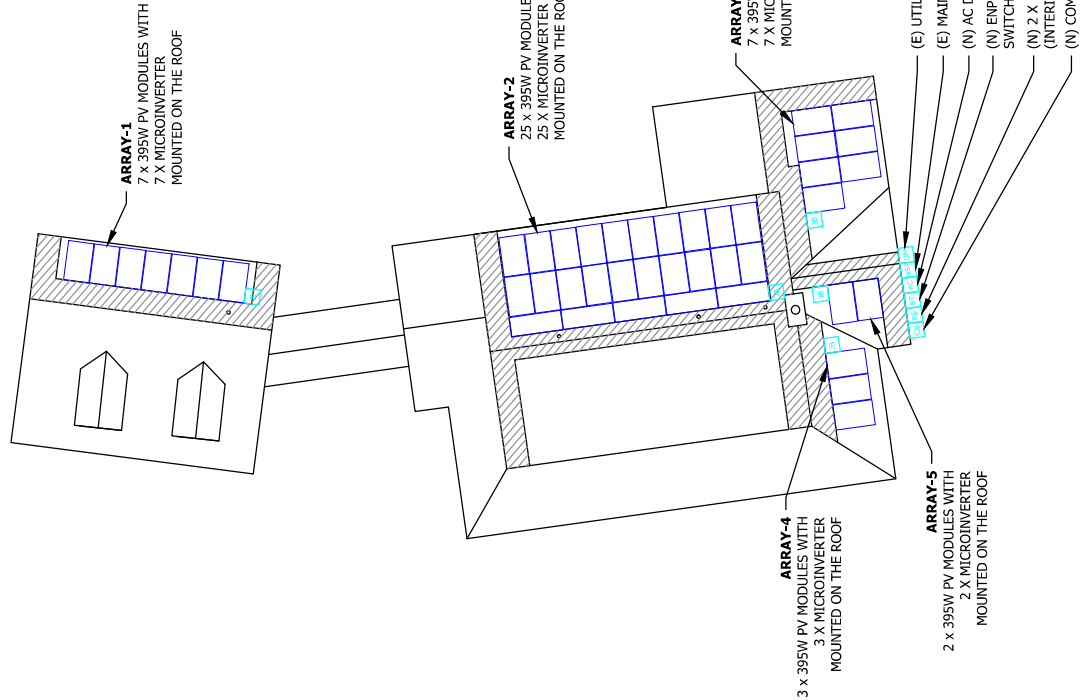

A SITE PLAN  
 PV-1.0 SCALE: 1/16"=1'-0"

### SYSTEM INFORMATION

DC SYSTEM SIZE : 17380W  
 AC SYSTEM SIZE : 12760W  
 MODULES:  
 (44) CANADIAN SOLAR CS1Y-395MS 395W  
 INVERTER:  
 (44) ENPHASE IQ8PLUS-72-2-US  
 BATTERY:  
 (2) ENPHASE ENERGY ENCHARGE 10, 10.5KWH  
 BRANCH DETAILS:  
 4 BRANCH OF 11 MICRO INVERTERS(11 MODULES)

### ENGINEER OF RECORD



Wyssling Consulting, PLLC  
 76 N Meadowbrook Drive Alpine UT 84004  
 North Carolina COA # P-2308

Signed 7/8/2022

THIS PLAN HAS BEEN ELECTRONICALLY SIGNED AND SEALED BY SCOTT WYSSLING, PE USING A DIGITAL SIGNATURE AND DATE. PRINTED COPIES OF THIS DOCUMENT ARE NOT CONSIDERED SIGNED AND SEALED, AND THE SIGNATURE MUST BE VERIFIED ON ANY COPIES OF THIS DOCUMENT.

### CUSTOMER INFORMATION

NAME & ADDRESS:  
 NICK SKATELL  
 1565 CHICORA RD.,  
 DUNN, NC 28334  
 35°30'54.4"N 78°67'48.1"W

AHD: HARNETT COUNTY

UTILITY: DUKE ENERGY PROGRESS

### SITE PLAN

PROJECT NUMBER:

DESIGNER/CHECKED BY:  
 DW/

SCALE: AS NOTED PAPER SIZE: 17"x11"

DATE: 6/30/22 REV: A PV-1.0

### GENERAL INFORMATION

ELECTRIC CODE	NEC 2020
FIRE CODE	NCFC 2018
RESIDENTIAL CODE	NCRC 2018
BUILDING CODE	NCBC 2018
WIND SPEED	115 MPH
SNOW LOAD	15 PSF

### INDEX

INDEX NO.	DESCRIPTION
PV-1.0	SITE PLAN
PV-2.0	GENERAL NOTES
PV-3.0	MOUNTING DETAILS
PV-3.1	STRUCTURAL DETAILS
PV-4.0	SINGLE LINE DIAGRAM
PV-4.1	SINGLE LINE DIAGRAM
PV-5.0	WARNING PLACARDS
PV-6.0+	SPEC SHEET(S)



## GENERAL NOTES

### GENERAL NOTES

1. MODULES ARE LISTED UNDER UL 1703 AND CONFORM TO THE STANDARDS.
2. INVERTERS ARE LISTED UNDER UL 1741 AND CONFORM TO THE STANDARDS.
3. DRAWINGS ARE DIAGRAMMATIC, INDICATING GENERAL ARRANGEMENT OF THE PV SYSTEM AND THE ACTUAL SITE CONDITION MIGHT VARY.
4. WORKING CLEARANCES AROUND THE NEW PV ELECTRICAL EQUIPMENT WILL BE MAINTAINED IN ACCORDANCE WITH NEC 110.26(A)(1).
5. ALL GROUND WIRING CONNECTED TO THE MAIN SERVICE GROUNDING IN MAIN SERVICE PANEL/ SERVICE EQUIPMENT.
6. ALL CONDUCTORS SHALL BE 600V, 75°C STANDARD COPPER UNLESS OTHERWISE NOTED.
7. WHEN REQUIRED, A LADDER SHALL BE IN PLACE FOR INSPECTION IN COMPLIANCE WITH OSHA REGULATIONS.
8. THE SYSTEM WILL NOT BE INTERCONNECTED BY THE CONTRACTOR UNTIL APPROVAL FROM THE LOCAL JURISDICTION AND/OR THE UTILITY.
9. ROOF ACCESS POINT SHALL BE LOCATED IN AREAS THAT DO NOT REQUIRE THE PLACEMENT OF GROUND LADDERS OVER OPENINGS SUCH AS WINDOWS OR DOORS, AND LOCATED AT STRONG POINTS OF BUILDING CONSTRUCTION WHERE THE ACCESS POINT DOES NOT CONFLICT WITH OVERHEAD OBSTRUCTIONS SUCH AS TREES, WIRES OR SIGNS.
10. PV ARRAY COMBINER/JUNCTION BOX PROVIDES TRANSITION FROM ARRAY WIRING TO CONDUIT WIRING

### EQUIPMENT LOCATION:

11. ALL EQUIPMENT SHALL MEET MINIMUM SETBACKS AS REQUIRED BY NEC 110.26(A)(1).
12. WIRING SYSTEMS INSTALLED IN DIRECT SUNLIGHT MUST BE RATED FOR EXPECTED OPERATING TEMPERATURE AS SPECIFIED BY NEC 690.31(A),(C) AND NEC TABLES 310.15(B)(2)(A) AND 310.15(B)(3)(C).
13. JUNCTION AND PULL BOXES PERMITTED INSTALLED UNDER PV MODULES ACCORDING TO NEC 690.34.
14. ADDITIONAL AC DISCONNECT(S) SHALL BE PROVIDED WHERE THE INVERTER IS NOT WITHIN SIGHT OF THE AC SERVICING DISCONNECT.
15. ALL EQUIPMENT SHALL BE INSTALLED ACCESSIBLE TO QUALIFIED PERSONNEL ACCORDING TO NEC APPLICABLE CODES.
16. ALL COMPONENTS ARE LISTED FOR THEIR PURPOSE AND RATED FOR OUTDOOR USAGE WHEN APPROPRIATE.

### STRUCTURAL NOTES:

17. RACKING SYSTEM & PV ARRAY WILL BE INSTALLED ACCORDING TO CODE-COMPLIANT INSTALLATION MANUAL. TOP CLAMPS REQUIRE A DESIGNATED SPACE BETWEEN MODULES, AND RAILS MUST ALSO EXTEND A MINIMUM DISTANCE BEYOND EITHER EDGE OF THE ARRAY/SUBARRAY, ACCORDING TO RAIL MANUFACTURER'S INSTRUCTIONS.
18. JUNCTION BOX WILL BE INSTALLED PER MANUFACTURER'S SPECIFICATIONS. IF ROOF-PENETRATING TYPE, IT SHALL BE FLASHED & SEALED PER LOCAL REQUIREMENTS.
19. ROOFTOP PENETRATIONS FOR PV RACEWAY WILL BE COMPLETED AND SEALED WITH APPROVED CHEMICAL SEALANT PER CODE BY A LICENSED CONTRACTOR.
20. ALL PV RELATED ROOF ATTACHMENTS TO BE SPACED NO GREATER THAN THE SPAN DISTANCE SPECIFIED BY THE RACKING MANUFACTURER.
21. WHEN POSSIBLE, ALL PV RELATED RACKING ATTACHMENTS WILL BE STAGGERED AMONGST THE ROOF FRAMING MEMBERS.

### WIRING & CONDUIT NOTES:

22. ALL CONDUIT AND WIRE WILL BE LISTED AND APPROVED FOR THEIR PURPOSE. CONDUIT AND WIRE SPECIFICATIONS ARE BASED ON MINIMUM CODE REQUIREMENTS AND ARE NOT MEANT TO LIMIT UP-SIZING.
23. CONDUCTORS SIZED ACCORDING TO NEC 690.8, NEC 690.7.
24. DC WIRING LIMITED TO MODULE FOOTPRINT. MICRO INVERTER WIRING SYSTEMS SHALL BE LOCATED AND SECURED UNDER THE ARRAY WITH SUITABLE WIRING CLIPS.
25. AC CONDUCTORS COLORED OR MARKED AS FOLLOWS: PHASE A OR L1- BLACK PHASE B OR L2- RED, OR OTHER CONVENTION IF THREE PHASE PHASE C OR L3- BLUE, YELLOW, ORANGE\*\*, OR OTHER CONVENTION NEUTRAL- WHITE OR GREY IN 4-WIRE DELTA CONNECTED SYSTEMS THE PHASE WITH HIGHER VOLTAGE TO BE MARKED ORANGE [NEC 110.15].

### INTERCONNECTION NOTES:

26. LOAD-SIDE INTERCONNECTION SHALL BE IN ACCORDANCE WITH [NEC 690.64(B)].
27. THE SUM OF THE UTILITY OCPD AND INVERTER CONTINUOUS INPUT MAY NOT EXCEED 120% OF BUSBAR RATING [NEC 705.12(D)(2)(3)].
28. WHEN SUM OF THE PV SOURCES EQUALS > 100% OF BUSBAR RATING, PV DEDICATED BACKFED BREAKERS MUST BE LOCATED OPPOSITE END OF THE BUS FROM THE UTILITY SOURCE OCPD [NEC 705.12(D)(2)(3)].
29. AT MULTIPLE PV OUTPUT COMBINER PANEL, TOTAL RATING OF ALL OVER CURRENT DEVICES SHALL NOT EXCEED AMPACITY OF BUSBAR. HOWEVER, THE COMBINED OVER CURRENT DEVICE MAY BE EXCLUDED ACCORDING TO NEC 705.12(D)(2)(3)(C).
30. FEEDER TAP INTER CONNECTION (LOAD SIDE) ACCORDING TO NEC 705.12(D)(2)(1) SUPPLY SIDE TAP INTERCONNECTION ACCORDING TO NEC 705.12(A) WITH SERVICE ENTRANCE CONDUCTORS IN ACCORDANCE WITH NEC 230.42 BACK FEEDING BREAKER FOR UTILITY-INTERACTIVE INVERTER OUTPUT IS EXEMPT FROM ADDITIONAL FASTENING [NEC 705.12(D)(5)].

### GROUNDING NOTES:

31. GROUNDING SYSTEM COMPONENTS SHALL BE LISTED FOR THEIR PURPOSE, AND GROUNDING DEVICES EXPOSED TO THE ELEMENTS SHALL BE RATED FOR SUCH USE.
32. PV EQUIPMENT SHALL BE GROUNDING ACCORDING TO NEC 690.43 AND MINIMUM NEC 250.122.
33. METAL PARTS OF MODULE FRAMES, MODULE RACKING, AND ENCLOSURES CONSIDERED GROUNDING IN ACCORD WITH 250.134 AND 250.136(A).
34. EQUIPMENT GROUNDING CONDUCTORS SHALL BE SIZED ACCORDING TO NEC 690.45 AND MICRO INVERTER MANUFACTURER'S INSTRUCTIONS.
35. EACH MODULE WILL BE GROUNDING USING WEBB GROUNDING CLIPS AS SHOWN IN MANUFACTURER DOCUMENTATION AND APPROVED BY THE AHJ. IF WEBBS ARE NOT USED, MODULE GROUNDING LUGS MUST BE INSTALLED AT THE SPECIFIED GROUNDING LUG HOLES PER THE MANUFACTURER'S INSTALLATION REQUIREMENTS.
36. THE GROUNDING CONNECTION TO A MODULE SHALL BE ARRANGED SUCH THAT THE REMOVAL OF A MODULE DOES NOT INTERRUPT A GROUNDING CONDUCTOR TO ANOTHER MODULE.
37. GROUNDING AND BONDING CONDUCTORS, IF INSULATED, SHALL BE COLORED GREEN OR MARKED GREEN IF #4 AWG OR LARGER [NEC 250.119].
38. THE GROUNDING ELECTRODE SYSTEM COMPLIES WITH NEC 690.47 AND NEC 250.50 THROUGH 250.106. IF EXISTING SYSTEM IS INACCESSIBLE, OR INADEQUATE, A GROUNDING ELECTRODE SYSTEM PROVIDED ACCORDING TO NEC 250.50, NEC 690.47, AND AHJ.
39. GROUND-FAULT DETECTION SHALL COMPLY WITH NEC 690.5 IN GENERAL AND NEC 690.5(A)(1) SPECIFICALLY.
40. DISCONNECT AND OVER-CURRENT PROTECTION NOTES:
41. DISCONNECTING SWITCHES SHALL BE WIRED SUCH THAT WHEN THE SWITCH IS OPENED THE CONDUCTORS REMAINING ENERGIZED ARE CONNECTED TO THE TERMINALS MARKED "LINE SIDE" (TYPICALLY THE UPPER TERMINALS).
42. DISCONNECTS TO BE ACCESSIBLE TO QUALIFIED UTILITY PERSONNEL, BE LOCKABLE, AND BE A VISIBLE-BREAK SWITCH
43. RAPID SHUTDOWN OF ENERGIZED CONDUCTORS BEYOND 10 FT OF PV ARRAY OR 5 FT INSIDE A BUILDING WITHIN 10 SECONDS. CONTROLLED CONDUCTORS ≤30V AND ≤240VA [NEC 690.12]. LOCATION OF LABEL ACCORDING TO AHJ.
44. ALL OCPD RATINGS AND TYPES SPECIFIED ACCORDING TO NEC 690.8, 690.9 AND 240.
45. MICRO INVERTER BRANCHES REQUIRED TO A SINGLE BREAKER OR GROUPED FUSES IN ACCORDANCE WITH NEC 110.3(B), 2.6.7 IF REQUIRED BY AHJ. SYSTEM WILL INCLUDE ARC-FAULT CIRCUIT PROTECTION ACCORDING TO NEC 690.11 AND UL1699B.

**Scott  
Wysli  
ng, PE**

Digitally signed by Scott Wysli,  
DN: cn=U.S. S=U.S., L=Alpine,  
o=Wysli Consulting,  
ou=Engineering, cn=Scott  
Wysli, email=Wysli@wysliconsulting.com,  
c=US  
Reason: I am the author of this  
document  
Location: your signing location  
Date: 2022.07.08 11:35:13-08'00'  
Font PDF Editor Version: 11.1.0

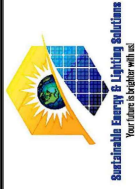

## SYSTEM INFORMATION

DC SYSTEM SIZE : 17380W  
AC SYSTEM SIZE : 12760W  
MODULES:  
INVERTER:  
(44) CANADIAN SOLAR CS1Y-395MS 395W  
(44) ENPHASE IQ8PLUS-72-2-US  
BATTERY:  
(2) ENPHASE ENERGY ENCHARGE 10, 10.5KWH  
BRANCH DETAILS:  
4 BRANCH OF 11 MICRO INVERTERS(11 MODULES)

## ENGINEER OF RECORD



Wysli Consulting, PLLC  
76 N Meadbrook Drive Alpine UT 84004  
North Carolina COA # P-2308

Signed 7/8/2022

THIS PLAN HAS BEEN ELECTRONICALLY SIGNED AND SEALED BY SCOTT WYSLI. BY USING A DIGITAL SIGNATURE AND DATE, PRINTED COPIES OF THIS DOCUMENT ARE NOT CONSIDERED SIGNED AND SEALED AND THE SIGNATURE MUST BE VERIFIED ON A PAPER COPY OF THIS PLAN.

## CUSTOMER INFORMATION

NAME & ADDRESS:  
NICK SKATELL  
1565 CHICORA RD.,  
DUNN, NC 28334  
35°30'54.4"N 78°67'48.1"W

AHJ: HARNETT COUNTY

UTILITY: DUKE ENERGY PROGRESS

## GENERAL NOTES

PROJECT NUMBER:

DESIGNER/CHECKED BY:  
DW/

SCALE: AS NOTED PAPER SIZE: 17"x11"

DATE: 6/30/22 REV: A PV-2.0

**MODULES DATA**

CANADIAN SOLAR CS1Y-395MS 395W
MODULE DIMS 79.6"X39.2"X1.38"
LAG SCREWS 5/16"X3.5"; 2.5" MIN EMBEDMENT

**FIRE SETBACK**

MINIMUM FIRE ACCESS PATHWAYS PER CFC 2019  
 RIDGE TO ARRAY: 1'-6"  
 HIP/VALLEY W/ ADJACENT ARRAY: 3'-0"  
 HIP/VALLEY W/O ADJACENT ARRAY: 1'-6"  
 EACH SIDE HIP/VALLEY W/O ADJACENT ARRAY: 0'-0"

**NOTE:** INSTALLER TO VERIFY RAFTER SIZE, SPACING AND SLOPED SPANS, AND NOTIFY ANY DISCREPANCIES BEFORE PROCEEDING.

**AERIAL VIEW**

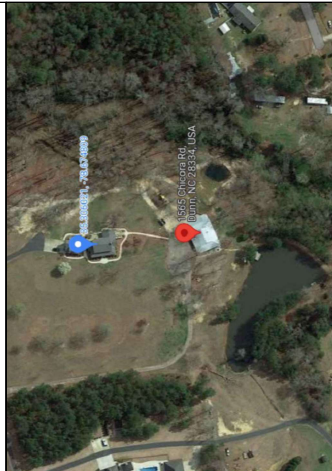

**SITE INFORMATION**

SR.NO	AZIMUTH	PITCH	NO. OF MODULES	ARRAY AREA (SQ. FT.)	ROOF TYPE	ATTACHMENT	ROOF EXPOSURE	FRAME TYPE	FRAME SIZE	FRAME SPACING	MAX RAIL SPAN	OVER HANG
MP-01	89°	22.62°	7	151.69	METAL	S-51 CORRUBRACKET	METAL DECK	RAFTERS	2 X 6	2'-0"	4'-0"	2'-0"
MP-02	82°	22.62°	25	541.75	METAL	S-51 CORRUBRACKET	METAL DECK	RAFTERS	2 X 6	2'-0"	4'-0"	2'-0"
MP-03	172°	22.62°	7	151.69	METAL	S-51 CORRUBRACKET	METAL DECK	RAFTERS	2 X 6	2'-0"	4'-0"	2'-0"
MP-04	172°	22.62°	3	65.01	METAL	S-51 CORRUBRACKET	METAL DECK	RAFTERS	2 X 6	2'-0"	4'-0"	2'-0"
MP-05	268°	22.62°	2	43.34	METAL	S-51 CORRUBRACKET	METAL DECK	RAFTERS	2 X 6	2'-0"	4'-0"	2'-0"

Digitally signed by Scott Wyssling, PE  
 DN: cn=US, o=Scott Wyssling, ou=Engineering, ou=Wyssling Consulting, email=Scott.Wyssling@wysslingconsulting.com, c=US  
 Location: your signing location  
 Date: 2022.07.08 11:35:23-06'00'  
 Power PDF Editor Version: 11.1.0

**Scott Wyssling, PE**

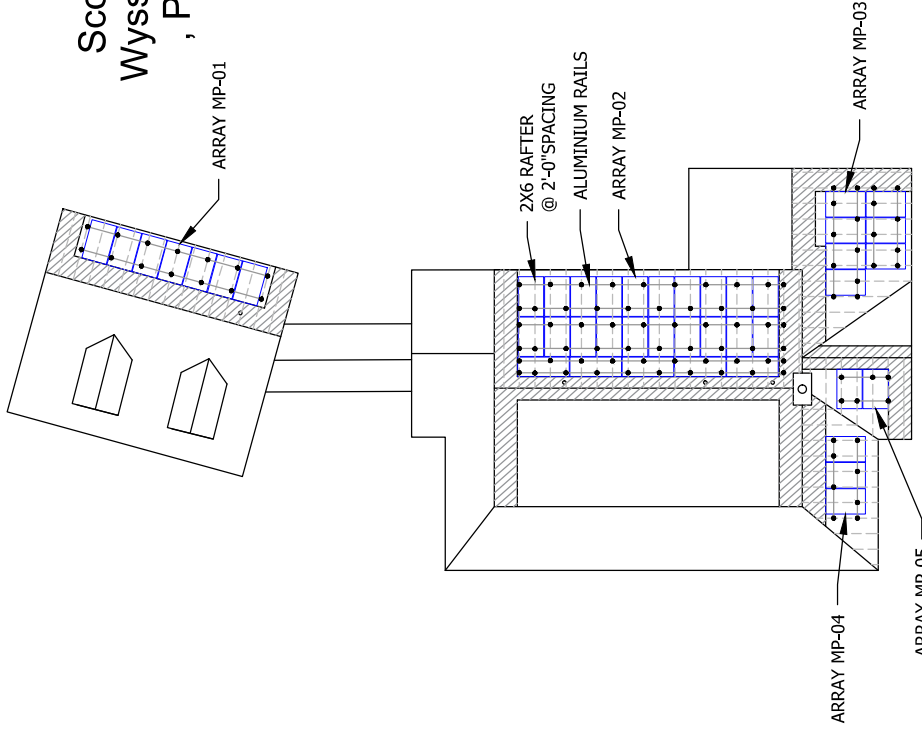
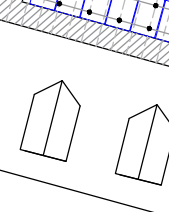

**SYSTEM INFORMATION**  
 DC SYSTEM SIZE : 17380W  
 AC SYSTEM SIZE : 12760W  
 MODULES:  
 (44) CANADIAN SOLAR CS1Y-395MS 395W  
 INVERTER:  
 (44) ENPHASE IQ8PLUS-72-2-US  
 BATTERY:  
 (2) ENPHASE ENERGY ENCHARGE 10, 10.5KWH  
 BRANCH DETAILS:  
 4 BRANCH OF 11 MICRO INVERTERS(11 MODULES)

**ENGINEER OF RECORD**

Wysling Consulting, PLLC  
 76 N Meadowbrook Drive Alpine UT 84004  
 North Carolina COA # P-2308  
 Signed 7/8/2022

**CUSTOMER INFORMATION**

NAME & ADDRESS:  
 NICK SKATELL  
 1565 CHICORA RD.,  
 DUNN, NC 28334  
 35°30'54.4"N 78°67'48.1"W

AHD: HARNETT COUNTY  
 UTILITY: DUKE ENERGY PROGRESS

**MOUNTING DETAILS**

PROJECT NUMBER:  
 DESIGNER/CHECKED BY:  
 DW/  
 SCALE: AS NOTED  
 DATE: 6/30/22  
 REV: A  
 PV-3.0

**B** MOUNTING DETAILS  
 SCALE: 1/16" = 1'-0"



**SYSTEM INFORMATION**

DC SYSTEM SIZE : 17380W  
 AC SYSTEM SIZE : 12760W  
 MODULES:  
 (44) CANADIAN SOLAR CS1Y-395MS 395W  
 INVERTER:  
 (44) ENPHASE IQ8PLUS-72-2-US  
 BATTERY:  
 (2) ENPHASE ENERGY ENCHARGE 10, 10.5KWH  
 BRANCH DETAILS:  
 4 BRANCH OF 11 MICRO INVERTERS(11 MODULES)

**ENGINEER OF RECORD**



Wyssling Consulting, PLLC  
 76 N Meadowbrook Drive Alpine UT 84004  
 North Carolina COA # P-2308

Signed 7/8/2022

**THIS PLAN HAS BEEN ELECTRONICALLY SIGNED AND SEALED BY SCOTT WYSSLING, PE USING A DIGITAL SIGNATURE AND DATE. PRINTED COPIES OF THIS DOCUMENT ARE NOT CONSIDERED SIGNED AND SEALED, AND THE SIGNATURE MUST BE VERIFIED ON A HARD COPY OF THIS DOCUMENT.**

**CUSTOMER INFORMATION**

NAME & ADDRESS:  
 NICK SKATELL  
 1565 CHICORA RD.,  
 DUNN, NC 28334  
 35°30'54.4"N 78°67'48.1"W

AHD: HARNETT COUNTY

UTILITY: DUKE ENERGY PROGRESS

**STRUCTURAL DETAILS**

PROJECT NUMBER:

DESIGNER/CHECKED BY:  
 DW/

SCALE: AS NOTED

DATE: 6/30/22

REV: A

PV-3.1

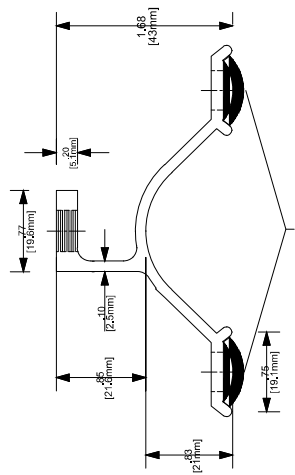
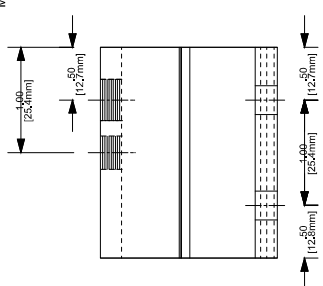
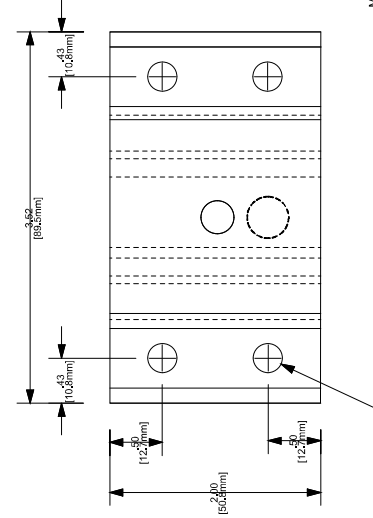
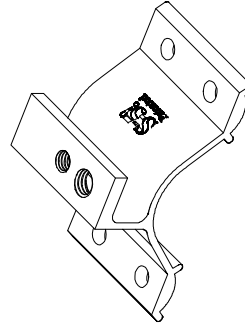
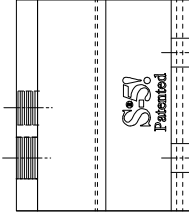
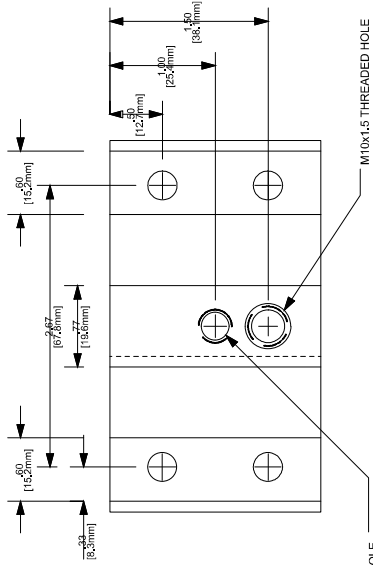

FACTORY APPLIED BUTYL SEALANT DIM: 3/4" X 1/8"

Digitally signed by Scott Wyssling, PE  
 DN: C=US, S=Utah, L=Alpine, OU=Wyssling Consulting, OU=Engineering, CN=Scott Wyssling, PE  
 E=swyssling@wysslingconsulting.com  
 Reason: I am the author of this document.  
 Date: 2022.07.08  
 Foxit PDF Editor version: 11.1.0

**Scott Wyssling, PE**

**S-51 CORRUBRACKET**







**WARNING PLACARDS**

ALL PLACARDS SHALL BE OF WEATHER PROOF CONSTRUCTION, BACKGROUND ON ALL PLACARDS SHALL BE RED WITH WHITE LETTERING U.O.N. PLACARD SHALL BE MOUNTED DIRECTLY ON THE EXISTING UTILITY ELECTRICAL SERVICE FASTENERS APPROVED BY THE LOCAL JURISDICTION

NOTE: ALL SIGNAGE CANNOT BE HAND WRITTEN NEC 110.21

**WARNING**  
ELECTRIC SHOCK HAZARD  
THE DC CONDUCTORS OF THIS PHOTOVOLTAIC SYSTEM ARE UNGROUNDED AND MAY BE ENERGIZED

LABEL LOCATION  
DC DISCONNECT, INVERTER  
[PER CODE: NEC 690.41(I)]

**WARNING**  
ELECTRIC SHOCK HAZARD  
DO NOT TOUCH TERMINALS  
TERMINALS ON BOTH LINE AND LOAD SIDES MAY BE ENERGIZED IN THE OPEN POSITION

LABEL LOCATION  
POINT OF INTERCONNECTION  
[PER CODE: NEC 690.13(B)]

**WARNING**  
ELECTRIC SHOCK HAZARD  
DO NOT TOUCH TERMINALS  
TERMINALS ON BOTH LINE AND LOAD SIDES MAY BE ENERGIZED IN THE OPEN POSITION

LABEL LOCATION  
POINT OF INTERCONNECTION  
[PER CODE: NEC 690.13(B)]

**WARNING**  
ELECTRIC SHOCK HAZARD  
DO NOT TOUCH TERMINALS  
TERMINALS ON BOTH LINE AND LOAD SIDES MAY BE ENERGIZED IN THE OPEN POSITION

LABEL LOCATION  
POINT OF INTERCONNECTION  
[PER CODE: NEC 690.13(B)]

**WARNING**  
ELECTRIC SHOCK HAZARD  
DO NOT TOUCH TERMINALS  
TERMINALS ON BOTH LINE AND LOAD SIDES MAY BE ENERGIZED IN THE OPEN POSITION

LABEL LOCATION  
POINT OF INTERCONNECTION  
[PER CODE: NEC 690.13(B)]

**WARNING**  
ELECTRIC SHOCK HAZARD  
DO NOT TOUCH TERMINALS  
TERMINALS ON BOTH LINE AND LOAD SIDES MAY BE ENERGIZED IN THE OPEN POSITION

LABEL LOCATION  
POINT OF INTERCONNECTION  
[PER CODE: NEC 690.13(B)]

**WARNING**  
ELECTRIC SHOCK HAZARD  
DO NOT TOUCH TERMINALS  
TERMINALS ON BOTH LINE AND LOAD SIDES MAY BE ENERGIZED IN THE OPEN POSITION

LABEL LOCATION  
POINT OF INTERCONNECTION  
[PER CODE: NEC 690.13(B)]

**WARNING**  
ELECTRIC SHOCK HAZARD  
DO NOT TOUCH TERMINALS  
TERMINALS ON BOTH LINE AND LOAD SIDES MAY BE ENERGIZED IN THE OPEN POSITION

LABEL LOCATION  
POINT OF INTERCONNECTION  
[PER CODE: NEC 690.13(B)]

**WARNING**  
ELECTRIC SHOCK HAZARD  
DO NOT TOUCH TERMINALS  
TERMINALS ON BOTH LINE AND LOAD SIDES MAY BE ENERGIZED IN THE OPEN POSITION

LABEL LOCATION  
POINT OF INTERCONNECTION  
[PER CODE: NEC 690.13(B)]

**WARNING**  
ELECTRIC SHOCK HAZARD  
DO NOT TOUCH TERMINALS  
TERMINALS ON BOTH LINE AND LOAD SIDES MAY BE ENERGIZED IN THE OPEN POSITION

LABEL LOCATION  
POINT OF INTERCONNECTION  
[PER CODE: NEC 690.13(B)]

**WARNING**  
ELECTRIC SHOCK HAZARD  
DO NOT TOUCH TERMINALS  
TERMINALS ON BOTH LINE AND LOAD SIDES MAY BE ENERGIZED IN THE OPEN POSITION

LABEL LOCATION  
POINT OF INTERCONNECTION  
[PER CODE: NEC 690.13(B)]

**WARNING**  
ELECTRIC SHOCK HAZARD  
THE DC CONDUCTORS OF THIS PHOTOVOLTAIC SYSTEM ARE UNGROUNDED AND MAY BE ENERGIZED

LABEL LOCATION  
DC DISCONNECT, INVERTER  
[PER CODE: NEC 690.41(I)]

**WARNING**  
ELECTRIC SHOCK HAZARD  
DO NOT TOUCH TERMINALS  
TERMINALS ON BOTH LINE AND LOAD SIDES MAY BE ENERGIZED IN THE OPEN POSITION

LABEL LOCATION  
POINT OF INTERCONNECTION  
[PER CODE: NEC 690.13(B)]

**WARNING**  
ELECTRIC SHOCK HAZARD  
DO NOT TOUCH TERMINALS  
TERMINALS ON BOTH LINE AND LOAD SIDES MAY BE ENERGIZED IN THE OPEN POSITION

LABEL LOCATION  
POINT OF INTERCONNECTION  
[PER CODE: NEC 690.13(B)]

**WARNING**  
ELECTRIC SHOCK HAZARD  
DO NOT TOUCH TERMINALS  
TERMINALS ON BOTH LINE AND LOAD SIDES MAY BE ENERGIZED IN THE OPEN POSITION

LABEL LOCATION  
POINT OF INTERCONNECTION  
[PER CODE: NEC 690.13(B)]

**WARNING**  
ELECTRIC SHOCK HAZARD  
DO NOT TOUCH TERMINALS  
TERMINALS ON BOTH LINE AND LOAD SIDES MAY BE ENERGIZED IN THE OPEN POSITION

LABEL LOCATION  
POINT OF INTERCONNECTION  
[PER CODE: NEC 690.13(B)]

**WARNING**  
ELECTRIC SHOCK HAZARD  
DO NOT TOUCH TERMINALS  
TERMINALS ON BOTH LINE AND LOAD SIDES MAY BE ENERGIZED IN THE OPEN POSITION

LABEL LOCATION  
POINT OF INTERCONNECTION  
[PER CODE: NEC 690.13(B)]

**WARNING**  
ELECTRIC SHOCK HAZARD  
DO NOT TOUCH TERMINALS  
TERMINALS ON BOTH LINE AND LOAD SIDES MAY BE ENERGIZED IN THE OPEN POSITION

LABEL LOCATION  
POINT OF INTERCONNECTION  
[PER CODE: NEC 690.13(B)]

**WARNING**  
ELECTRIC SHOCK HAZARD  
DO NOT TOUCH TERMINALS  
TERMINALS ON BOTH LINE AND LOAD SIDES MAY BE ENERGIZED IN THE OPEN POSITION

LABEL LOCATION  
POINT OF INTERCONNECTION  
[PER CODE: NEC 690.13(B)]

**WARNING**  
ELECTRIC SHOCK HAZARD  
DO NOT TOUCH TERMINALS  
TERMINALS ON BOTH LINE AND LOAD SIDES MAY BE ENERGIZED IN THE OPEN POSITION

LABEL LOCATION  
POINT OF INTERCONNECTION  
[PER CODE: NEC 690.13(B)]

**WARNING**  
ELECTRIC SHOCK HAZARD  
DO NOT TOUCH TERMINALS  
TERMINALS ON BOTH LINE AND LOAD SIDES MAY BE ENERGIZED IN THE OPEN POSITION

LABEL LOCATION  
POINT OF INTERCONNECTION  
[PER CODE: NEC 690.13(B)]

**WARNING**  
ELECTRIC SHOCK HAZARD  
DO NOT TOUCH TERMINALS  
TERMINALS ON BOTH LINE AND LOAD SIDES MAY BE ENERGIZED IN THE OPEN POSITION

LABEL LOCATION  
POINT OF INTERCONNECTION  
[PER CODE: NEC 690.13(B)]

**WARNING !**

POWER TO THIS BUILDING IS ALSO SUPPLIED FROM THE FOLLOWING SOURCES WITH DISCONNECTS LOCATED AS SHOWN

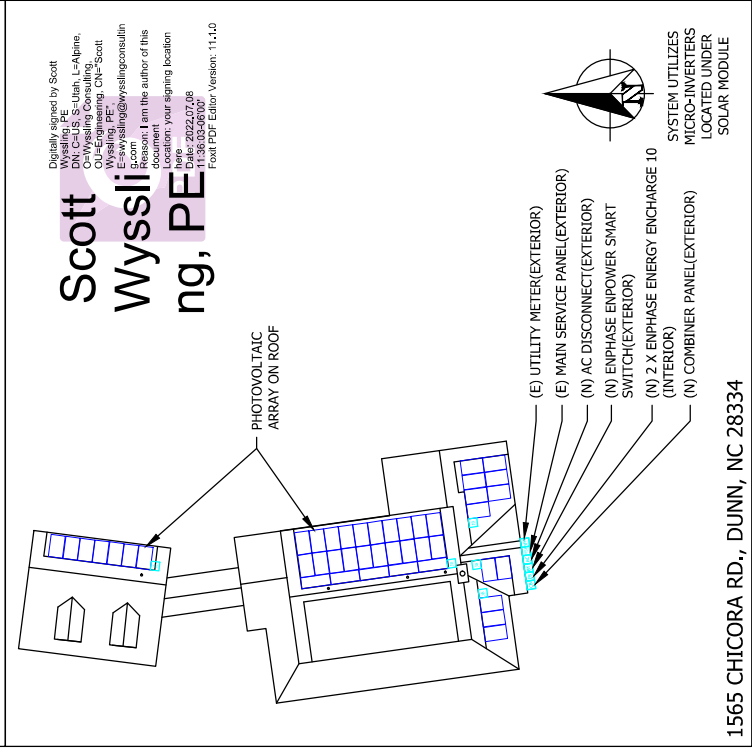

Digitally signed by Scott Wyssling, PE  
DN: c=US, s=Utah, L=Alpine, OU=Engineering, CN=Scott Wyssling, PE  
E=wyssling@wysslingconsulting.com  
Reason: I am the author of this document  
Date: 2022.07.08 10:38:05-0600  
Print PDF Editor Version: 11.1.0

**THIS PLAN HAS BEEN ELECTRONICALLY SIGNED AND SEALED BY SCOTT WYSSLING, PE USING A DIGITAL SIGNATURE AND DATE. PRINTED COPIES OF THIS DOCUMENT ARE NOT CONSIDERED SIGNED AND SEALED, AND THE SIGNATURE MUST BE VERIFIED ON ANY COPIES OF THIS DOCUMENT.**

**CUSTOMER INFORMATION**

NAME & ADDRESS:  
NICK SKATELL  
1565 CHICORA RD.,  
DUNN, NC 28334  
35°30'54.4"N 78°67'48.1"W

AHD: HARNETT COUNTY  
UTILITY: DUKE ENERGY PROGRESS

**WARNING PLACARDS**

PROJECT NUMBER:  
DESIGNER/CHECKED BY:  
DW/

SCALE: AS NOTED  
DATE: 6/30/22  
PAPER SIZE: 17"x11"  
REV: A  
PV-5.0

**SYSTEM INFORMATION**  
DC SYSTEM SIZE : 17380W  
AC SYSTEM SIZE : 12760W  
MODULES: (44) CANADIAN SOLAR CS1Y-395WS 395W  
INVERTER: (44) ENPHASE IQ8PLUS-72-2-US  
BATTERY: (2) ENPHASE ENERGY ENCHARGE 10, 10.5KWH  
BRANCH DETAILS: 4 BRANCH OF 11 MICRO INVERTERS (11 MODULES)

**ENGINEER OF RECORD**

Wyssling Consulting, PLLC  
76 N Meigswood Drive Alpine UT 84004  
North Carolina CEA # P-2308  
Signed 7/8/2022



## SYSTEM INFORMATION

DC SYSTEM SIZE : 17380W  
 AC SYSTEM SIZE : 12760W  
 MODULES: (44) CANADIAN SOLAR CS1Y-395MS 395W  
 INVERTER: (44) ENPHASE IQ8PLUS-72-2-US  
 BATTERY: (2) ENPHASE ENERGY ENCHARGE 10, 10.5KWH  
 BRANCH DETAILS: 4 BRANCH OF 11 MICRO INVERTERS(11 MODULES)

## ENGINEER OF RECORD

## CUSTOMER INFORMATION

NAME & ADDRESS:  
 NICK SKATELL  
 1565 CHICORA RD.,  
 DUNN, NC 28334  
 35°30'54.4"N 78°6'48.1"W

AHD: HARNETT COUNTY

UTILITY: DUKE ENERGY PROGRESS

## MODULE SPECSHEET

PROJECT NUMBER:

DESIGNER/CHECKED BY:  
 DW/

SCALE: AS NOTED PAPER SIZE: 17"x11"

DATE: 6/30/22 REV: A PV-6.0

### ENGINEERING DRAWING (mm)

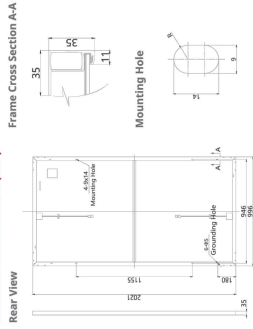

### CS1Y-400MS / I-V CURVES

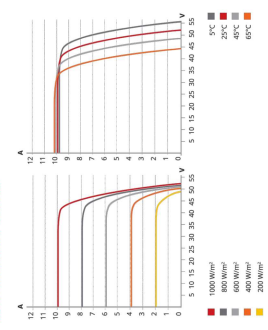

### MECHANICAL DATA

Specification	Data
Cell Type	Mono-crystalline
Dimensions	201 x 996 x 35 mm (79.6 x 39.2 x 1.38 in)
Weight	24.0 kg (52.9 lbs)
Front Cover	3.2 mm tempered glass
Frame	Anodized aluminum alloy
J-Box	IP68, 3 bypass diodes
Cable	4.0 mm² (IEC), 12 AWG (UL)
Cable Length (including Connector)	740 mm (29.1 in) (without optimizer or micro-inverter) * or 2000 mm (78.7 in) (+ micro-inverter) * (with optimizer or micro-inverter) * †
Connector	T4 series or MC4
Per Pallet	30 pieces

\* Adjacent two modules (opposite left and right modules, landscape up and down) must be connected to the same string.  
 † For detailed information, please contact your local Canadian Solar sales and technical representatives.

### TEMPERATURE CHARACTERISTICS

Specification	Data
Temperature Coefficient (Pmax)	-0.36 % / °C
Temperature Coefficient (Voc)	-0.28 % / °C
Temperature Coefficient (Isc)	0.05 % / °C

Nominal Module Operating Temperature 43 ± 3°C

### PARTNER SECTION



### ELECTRICAL DATA | STC\*

CS1Y	390MS	395MS	400MS	405MS
Nominal Max. Power (Pmax)	390 W	395 W	400 W	405 W
Opt. Operating Voltage (Vmp)	43.1 V	43.3 V	43.5 V	43.7 V
Opt. Operating Current (Imp)	9.05 A	9.13 A	9.20 A	9.27 A
Open Circuit Voltage (Voc)	51.9 V	52.1 V	52.3 V	52.5 V
Short Circuit Current (Isc)	9.82 A	9.86 A	9.90 A	9.94 A
Module Efficiency	19.4%	19.6%	19.9%	20.1%
Operating Temperature	-40°C ~ +85°C			
Max. System Voltage	1000V (IEC/UL)			
Module Fire Performance	TYPE I (UL 61730 1500V) or TYPE 2 (UL 61730 1000V) or CLASS C (IEC 61730)			
Max. Series Fuse Rating	16 A			
Application Classification	Class A			
Power Tolerance	0 ~ +10 W			

\* Under Standard Test Conditions (STC) of irradiance of 1000 W/m², spectrum AM 1.5 and cell temperature of 25°C

### ELECTRICAL DATA | NIMOT\*

CS1Y	390MS	395MS	400MS	405MS
Nominal Max. Power (Pmax)	289 W	293 W	297 W	300 W
Opt. Operating Voltage (Vmp)	39.9 V	40.1 V	40.3 V	40.4 V
Opt. Operating Current (Imp)	7.25 A	7.31 A	7.37 A	7.43 A
Open Circuit Voltage (Voc)	48.6 V	48.8 V	49.0 V	49.2 V
Short Circuit Current (Isc)	7.92 A	7.96 A	7.99 A	8.02 A

\* Under Nominal Module Operating Temperature (NIMOT), irradiance of 800 W/m², spectrum AM 1.5, ambient temperature 20°C, wind speed 1 m/s.

\* This specifications and key features contained in this datasheet may deviate slightly from our actual products. Canadian Solar reserves the right to make necessary adjustments to the information described herein at any time without notice. Please be kindly advised that PV modules should be handled and installed by qualified personnel who have professional skills and please carefully read the safety and installation instructions before using the products.

Canadian Solar (USA) Inc. February 2021 | All rights reserved | Module Product Datasheet v1.4\_P23\_JT\_NA



**NEW**

**HiDMS (All-Black)**  
 ALL-BLACK HIGH DENSITY MONO PERC MODULE  
 390 W ~ 405 W  
 CS1Y-390 | 395 | 400 | 405MS

### MORE POWER

- Aesthetically pleasing design blends into your roof
- Maximize the light absorption area, module efficiency up to 20.1 %
- Low temperature coefficient (Pmax): -0.36 % / °C
- Better shading tolerance

### MORE RELIABLE

- Lower internal current, lower hot spot temperature
- Minimizes micro-crack impacts
- Heavy snow load up to 7000 Pa, wind load up to 5400 Pa\*

**15 years** enhanced product warranty on materials and workmanship\*

**25 years** linear power output warranty\*

\*According to the applicable Canadian Solar Limited Warranty Statement.

### MANAGEMENT SYSTEM CERTIFICATES\*

ISO 9001:2015 / Quality management system  
 ISO 14001:2015 / Standards for environmental management system  
 ISO 50001:2018 / International standards for occupational health & safety

### PRODUCT CERTIFICATES\*

IEC 61215 / IEC 61730  
 UL 61730 / IEC 61701 / IEC 62716  
 Take-e-way



\* The specific certificate applicable to different module types and markets will vary, and therefore not all of the certificates listed herein will simultaneously apply to the product. Please refer to the specific certificates available for your product and applicable in the regions in which the products will be used.

Canadian Solar (USA) Inc. is committed to providing high quality solar products, solar system solutions and services to customers around the world. Canadian Solar was recognized as the No. 1 module supplier for quality and performance/price ratio in the IHS Module Customer Insight Survey, and is a leading PV project developer and manufacturer of solar modules, with over 50 GW deployed around the world since 2001.

\* For detailed information, please refer to Insulation Manual

Canadian Solar (USA) Inc.  
 3000 Oak Road, Suite 400, Walnut Creek, CA 94597, USA, www.csisolar.com/na, service.ca@csisolar.com



**SYSTEM INFORMATION**

DC SYSTEM SIZE : 17380W  
 AC SYSTEM SIZE : 12760W  
 MODULES:  
 INVERTER:  
 (44) CANADIAN SOLAR CS1Y-395WS 395W  
 (44) ENPHASE IQ8PLUS-72-2-US  
 BATTERY:  
 (2) ENPHASE ENERGY ENCHARGE 10, 10.5KWH  
 BRANCH DETAILS:  
 4 BRANCH OF 11 MICRO INVERTERS(11 MODULES)

**ENGINEER OF RECORD**

**CUSTOMER INFORMATION**

NAME & ADDRESS:  
 NICK SKATELL  
 1565 CHICORA RD.,  
 DUNN, NC 28334  
 35°30'54.4" N 78°6'748.1" W

AHD: HARNETT COUNTY

UTILITY: DUKE ENERGY PROGRESS

**INVERTER SPECSHEET**

PROJECT NUMBER:

DESIGNER/CHECKED BY:  
 DW/

SCALE: AS NOTED PAPER SIZE: 17"x11"

DATE: 6/30/22 REV: A

PV-6.1

**IQ8 and IQ8+ Microinverters**

INVERTER DATA (DC)		IQ8-80Z-2-US	IQ8PLUS-72Z-2-US
Commonly used module pairings <sup>1</sup>	W	235 - 350	235 - 440
Module compatibility		60-cell/720 half-cell	60-cell/720 half-cell and 72-cell/744 half-cell
MPTT voltage range	V	27 - 37	29 - 45
Operating range	V	25 - 48	25 - 58
Min/max start voltage	V	30 / 48	30 / 58
Max input DC voltage	V	50	60
Max DC current <sup>2</sup> (module Ibc)	A	15	15
Overvoltage class DC port		II	II
DC port backfeed current	mA	0	0
PV array configuration		In Ungrounded array, No additional DC side protection required; AC side protection requires max 20A per branch circuit.	
<b>OUTPUT DATA (AC)</b>		IQ8-80Z-2-US	IQ8PLUS-72Z-2-US
Peak output power	VA	245	300
Max continuous output power	VA	240	290
Nominal (L-L) voltage/range <sup>3</sup>	V	120	240 / 211 - 264
Max continuous output current	A	1.0	1.21
Nominal frequency	Hz	60	60
Extended frequency range	Hz	50 - 68	50 - 68
AC short circuit fault current over 3 cycles	Amps	2	2
AC short circuit fault current over Max units per 20 A(L-L) branch circuit <sup>4</sup>		16	15
Total harmonic distortion	%	<5%	<5%
Overvoltage class AC port		III	III
AC port backfeed current	mA	30	30
Power factor setting		10	10
Grid-tied power factor (adjustable)	%	0.85 leading - 0.85 lagging	0.85 leading - 0.85 lagging
Peak efficiency	%	97.5	97.6
CEC weighted efficiency	%	97	97
Night-time power consumption	mW	80	80
<b>MECHANICAL DATA</b>			
Ambient temperature range		-40°C to +60°C (-40°F to +140°F)	
Relative humidity range		4% to 100% (condensing)	
DC Connector type		MC4	
Dimensions (HxWxD)		210 mm (8.3") x 175 mm (6.9") x 30.2 mm (1.2")	
Weight		1.08 kg (2.38 lbs)	
Cooling		Natural convection - no fans	
Approved for wet locations		Yes	
Pollution degree		P03	
Enclosure		Class II double-insulated, corrosion resistant polymeric enclosure	
Emission category / IP exposure rating		NEMA Type 6 / outdoor	
<b>COMPLIANCE</b>			
Certifications		CA Rule 21 (UL 1741-SA), UL 62109-1, UL1741/IEEE517, FCC Part 15 Class B, ICES-0003 Class B, CAN/CSA-C22.2 No. 1071-01	
This product is UL Listed as PV Rapid Shut Down Equipment and conforms with NEC 2014, NEC 2017, and NEC 2020 section 690.12 and C221-2018 Rule 64-218 Rapid Shutdown of PV Systems, for AC and DC conductors, when installed according to manufacturer's instructions.			
(1) No embedded DC/AC ratio. See the component manufacturer's website for more information. (2) See the component manufacturer's website for more information. (3) See the component manufacturer's website for more information. (4) See the component manufacturer's website for more information.			



**IQ8 and IQ8+ Microinverters**

Our newest IQ8 Microinverters are the industry's first microgrid-forming, software-defined inverter with split-phase power conversion capability to convert DC power to AC power efficiently. The heart of the split-phase-capable microinverter is our proprietary application-specific integrated circuit (ASIC) which enables the microinverter to operate in grid-tied or on-grid modes. The chip is built in advanced 55nm technology with high speed digital logic and has super-fast response times to changing loads and grid events, alleviating constraints on battery sizing for home energy systems.



Part of the Enphase Energy System, IQ8 Series Microinverters integrate with the Enphase IQ Battery, Enphase IQ Gateway, and the Enphase App monitoring and analysis software.



IQ8 Series Microinverters are UL Listed as PV Rapid Shut Down Equipment and conform with various regulations, when installed according to manufacturer's instructions.



Connect PV modules quickly and easily to IQ8 Series Microinverters using the included O-DCC-2 adapter cable with plug-in play MC4 connectors.

© 2022 Enphase Energy. All rights reserved. Enphase, the Enphase logo, IQ8 Microinverters, and other names are trademarks of Enphase Energy, Inc. Data subject to change. IQ8SSP-09-0002-01-EN-US-2022-03-17

**Easy to install**

- Lightweight and compact with plug-in play connectors
- Power Line Communication (PLC) between components
- Faster installation with simple two-wire cabling

**High productivity and reliability**

- Produce power even when the grid is down\*
- More than one million cumulative hours of testing
- Class II double-insulated enclosure
- Optimized for the latest high-powered PV modules

**Microgrid-forming**

- Complies with the latest advanced grid support\*\*
- Remote automatic updates for the latest grid requirements
- Configurable to support a wide range of grid profiles
- Meets CA Rule 21 (UL 1741-SA) requirements

\* Only when installed with IQ System Controller 2.  
 \*\* IQ8 and IQ8plus supports split phase, 240V installations only.



**SYSTEM INFORMATION**

DC SYSTEM SIZE : 17380W  
 AC SYSTEM SIZE : 12760W

MODULES:  
 (44) CANADIAN SOLAR CS1Y-395WS 395W

INVERTER:  
 (44) ENPHASE IQ8PLUS-72-2-US

BATTERY:  
 (2) ENPHASE ENERGY ENCHARGE 10, 10.5KWH

BRANCH DETAILS:  
 4 BRANCH OF 11 MICRO INVERTERS(11 MODULES)

**ENGINEER OF RECORD**

**CUSTOMER INFORMATION**

NAME & ADDRESS:  
 NICK SKATELL  
 1565 CHICORA RD.,  
 DUNN, NC 28334  
 35°30'54.4"N 78°6'48.1"W

AHD: HARNETT COUNTY

UTILITY: DUKE ENERGY PROGRESS

**COMBINER SPECSHEET**

PROJECT NUMBER:  
 DESIGNER/CHECKED BY:  
 DW/

SCALE: AS NOTED PAPER SIZE: 17"x11"

DATE: 6/30/22 REV: A PV-6.2

**Enphase IQ Combiner 3-ES / 3C-ES**

<b>MODEL NUMBER</b>	IQ Combiner 3-ES (X-IQ-AM1-240-3-ES)
<b>DESCRIPTION</b>	IQ Combiner 3-ES with Enphase IQ Envoy certified circuit board for integrated revenue grade PV production metering (ANSI CT1200 +/- 0.5%) and consumption monitoring (+/- 2.5%). Includes a silver solar shield to match the Encharge storage system and Enpower smart switch and to deflect heat.
<b>DESCRIPTION</b>	IQ Combiner 3C-ES with Enphase IQ Envoy printed circuit board for integrated revenue grade PV production metering (ANSI CT1200 +/- 0.5%) and consumption monitoring (+/- 2.5%). Includes a silver solar shield to match the Encharge storage system and Enpower smart switch and to deflect heat. Includes a silver solar shield for systems up to 60 microinverters. (Available in the US, Canada, Mexico, Puerto Rico, and the US Virgin Islands, where there is adequate cellular service in the installation area.) Includes a silver solar shield to match the Encharge storage system and Enpower smart switch and to deflect heat.
<b>ACCESSORIES AND REPLACEMENT PARTS</b>	(not included, order separately)
<b>Ensemble Communications Kit (COMMS-CELLMODEM-M1)</b>	Includes COMMS-KIT-01 and CELLMODEM-M1 with 5-year data plan for Ensemble sites
<b>Circuit Breakers</b>	Supports Eaton BR210, BR215, BR220, BR230, BR240, BR250, and BR260 circuit breakers.
<b>Ensemble Circuit Breakers</b>	Supports Eaton BR210, BR215, BR220, BR230, BR240, BR250, and BR260 circuit breakers.
<b>BRK-15A-2-240</b>	15A, 2-pole, 240V AC, 60 Hz, 1500VA, 1500VA, Eaton BR215
<b>BRK-20A-2P-240</b>	20A, 2-pole, 240V AC, 60 Hz, 2000VA, 2000VA, Eaton BR220
<b>EPLC-01</b>	Power line carrier (communication bridge pair), quantity - one pair
<b>XA-SOLARSHIELD-ES</b>	Replacement solar shield for Combiner 3-ES / 3C-ES
<b>XA-PLUG-T20-3</b>	Accessory receptacle for Power Line Carrier in IQ Combiner 3-ES / 3C-ES (required for EPLC-01)
<b>XA-ENV-PCBA-3</b>	Replacement IQ Envoy printed circuit board (PCB) for Combiner 3-ES / 3C-ES

**ELECTRICAL SPECIFICATIONS**

<b>Rating</b>	Continuous duty
<b>System voltage</b>	120/240 VAC, 60 Hz
<b>Eaton BR series busbar rating</b>	125 A
<b>Max. continuous current rating</b>	65 A
<b>Max. continuous current rating (input from PV storage)</b>	64 A
<b>Branch circuits (solar and/or storage)</b>	90 A
<b>Max. fuse/circuit rating (output)</b>	Up to four 2-pole Eaton BR series Distributed Generation (DG) breakers only (not included)
<b>Max. total branch circuit breaker rating (input)</b>	80A of distributed generation / 95A with IQ Envoy breaker included
<b>Envoy breaker</b>	10A or 15A rating GE/Siemens/Eaton included
<b>Production metering CT</b>	200 A solid core pre-installed and wired to IQ Envoy
<b>Consumption monitoring CT (CT200-SPLT)</b>	A pair of 200 A split core current transformers

**MECHANICAL DATA**

<b>Dimensions (WxHxD)</b>	37.5 x 49.5 x 16.8 cm (14.75" x 19.5" x 6.63")
<b>Weight</b>	7.5 kg (16.5 lbs)
<b>Ambient temperature range</b>	-40° C to +46° C (-40° F to 115° F)
<b>Cooling</b>	Natural convection, plus heat shield
<b>Enclosure environmental rating</b>	Outdoor, NRTL-certified, NEMA type 3R, polycarbonate construction
<b>Wire sizes</b>	<ul style="list-style-type: none"> <li>• 20 A to 50 A breaker inputs: 14 to 4 AWG copper conductors</li> <li>• 4 to 10 A breaker inputs: 14 to 10 AWG copper conductors</li> <li>• Main and ground: 14 to 1/0 copper conductors</li> <li>• Always follow local code requirements for conductor sizing.</li> </ul>
<b>Altitude</b>	To 2000 meters (6,560 feet)

**INTERNET CONNECTION OPTIONS**

<b>Integrated Wi-Fi</b>	802.11b/g/n
<b>Cellular</b>	CELLMODEM-M1-06-4G based LTE-M1 cellular modem (included only with IQ Combiner 3C-ES). Note that an Enphase Mobile Connect cellular modem is required for all Ensemble installations.
<b>Ethernet</b>	Optional, 802.3, Cat5E (or Cat 6) UTP Ethernet cable (not included)
<b>Compliance, Combiner</b>	UL 1741, CAN/CSA C22.2 No. 1071, 47 CFR Part 15, Class B, ICES 003
<b>Compliance, IQ Envoy</b>	Production metering: ANSI CT1200 accuracy class 0.5 (PV production) Consumption metering: accuracy class 2.5 UL 60400-1/1/CAN/CSA 22.2 No. 61010-1

To learn more about Enphase offerings, visit [enphase.com](http://enphase.com)  
 © 2021 Enphase Energy. All rights reserved. Enphase, the Enphase logo, IQ Combiner, 3C-ES, and other trademarks or service names are trademarks of Enphase Energy, Inc. Data subject to change 2021-10-26.



Delta Sheet  
 Enphase Networking

**Enphase IQ Combiner 3-ES/3C-ES**  
 X-IQ-AM1-240-3-ES  
 X-IQ-AM1-240-3C-ES



- Smart**
- Includes IQ Envoy for communication and control
  - Includes LTE-M1 cell modem (included only with IQ Combiner 3C-ES)
  - Includes solar shield to match Ensemble aesthetics and deflect heat
  - Flexible networking supports Wi-Fi, Ethernet, or cellular
  - Optional AC receptacle available for PLC bridge
  - Provides production metering and consumption monitoring
- Simple**
- Reduced size from IQ Combiner+ (X-IQ-AM1-240-2) stud mounting brackets support single
  - Centered mounting brackets support single
  - Supports back and side conduit entry
  - Up to four 2-pole branch circuits for 240 VAC plug-in breakers (not included)
  - 80 A total PV or storage branch circuits
- Reliable**
- Durable NRTL-certified NEMA type 3R enclosure
  - Five-year limited warranty
  - Two-year labor reimbursement program coverage included for both the Combiner SKUs
  - UL listed



To learn more about Enphase offerings, visit [enphase.com](http://enphase.com)

# Enphase Encharge 10

The **Enphase Encharge 10™**, all-in-one AC-coupled storage system is **reliable, smart, simple, and safe**. It is comprised of three base Encharge 3™ storage units, has a total usable energy capacity of 10.08 kWh and twelve embedded grid-forming microinverters with 3.84 kW power rating. It provides backup capability and installers can quickly design the right system size to meet the needs of both new and retrofit solar customers.

### Reliable

- Proven high reliability IQ Series Microinverters
- 10-year limited warranty
- Three independent Encharge storage base units
- Twelve embedded IQ 8X-BAT Microinverters
- Passive cooling (no moving parts/fans)

### Smart

- Grid-forming capability for backup operation
- Remote software and firmware upgrade
- Mobile app-based monitoring and control
- Support for self consumption
- Utility time of use (TOU) optimization

### Simple

- Fully integrated AC battery system
- Quick and easy plug-and-play installation
- Interconnects with standard household AC wiring

### Safe

- Cells safety tested
- Lithium iron phosphate (LFP) chemistry for maximum safety and longevity



To learn more about Enphase offerings, visit [enphase.com](http://enphase.com)



## Enphase Encharge 10

<b>MODEL NUMBER</b> ENCHARGE-10-IP-NA	Encharge 10 battery storage system with integrated Enphase Microinverters and battery management unit (BMU). Includes: - Three Encharge 3.84 kWh base units (803-A01-US010-1-3) - Three Enphase IQ 8X-BAT microinverters (803-A01-US010-1-3) - Interconnect kit for wiring between batteries (810-C-1050-0)
<b>ACCESSORIES</b> ENCHARGE-HNDL-RT	One set of Encharge base unit installation handles
<b>OUTPUT (AC)</b> @ 240 VAC <sup>1</sup>	
Rated (continuous) output power	3.84 kVA
Peak output power	5.7 kVA (10 seconds)
Nominal voltage / range	240 / 211 – 264 VAC
Nominal frequency / range	60 / 57 – 61 Hz
Rated output current	16 A
Peak output current	24.6A (10 seconds)
Power factor (adjustable)	0.85 leading... 0.85 lagging
Maximum units per 20 A branch circuit	1 unit (single phase)
Interconnection	Single-phase
Maximum AC short circuit fault current over 3 cycles	69.6 Arms
Round trip efficiency <sup>2</sup>	89%
<b>BATTERY</b>	
Total capacity	10.5 kWh
Usable capacity	10.08 kWh
Round trip efficiency	96%
Nominal DC voltage	67.2 V
Maximum DC voltage	73.5 V
Ambient operating temperature range	-15° C to 55° C (5° F to 131° F) non-condensing
Optimum operating temperature range	0° C to 30° C (32° F to 86° F)
Chemistry	Lithium iron phosphate (LFP)
<b>MECHANICAL DATA</b>	
Dimensions (WxHxD)	1070 mm x 664 mm x 319 mm (42.13 in x 26.14 in x 12.56 in)
Weight	Three individual 44.2 kg (97.4 lbs) base units plus 21.1 kg (48.7 lbs) cover and mounting bracket; total 154.7 kg (341 lbs)
Enclosure	Outdoor – NEMA type 3R
IQ 8X-BAT microinverter enclosure	NEMA Type 6
Cooling	Natural convection – No fans
Altitude	Up to 2500 meters (8200 feet)
Mounting	Wall mount
<b>FEATURES AND COMPLIANCE</b>	
Compatibility	Compatible with grid-tied PV systems. Compatible with Enphase M215/M250 and IQ Series Micro Inverter, Enphase Envoy, and Enphase IQ Envoy for backup operation.
Communication	Wireless 2.4 GHz
Services	Backup; self consumption; TOU; Demand Charge; NEM Integrity
Monitoring	Enlighten Manager and MyEnlighten monitoring options; API integration
Compliance	UL 9540, UL 9540A, UL 1998, UL 1991, NEMA Type 3R, AC156 EN 50538-3, IEC 62109-2, IEC 62109-1, IEC 62109-2, UL 1741USA, CAN/CSA C22.2 No. 1071-1-16, and IEEE 1547 Cell Module: UL 1973, UN 38.3
<b>LIMITED WARRANTY</b>	
Limited Warranty <sup>3</sup>	>70% capacity, up to 10 years or 4000 cycles
	1. Supported in backup/off grid operations 2. AC to Battery to AC at 50% power rating. 3. Whichever occurs first. Restrictions apply.

To learn more about Enphase offerings, visit [enphase.com](http://enphase.com)

© 2021 Enphase Energy. All rights reserved. Enphase, the Enphase logo, Encharge 10, and other trademarks or service names are the trademarks of Enphase Energy, Inc. Data subject to change. 2021.03-01

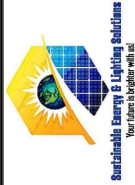

## SYSTEM INFORMATION

DC SYSTEM SIZE : 17380W  
AC SYSTEM SIZE : 12760W

MODULES:  
(44) CANADIAN SOLAR CS1Y-395WS 395W  
INVERTER:  
(44) ENPHASE IQ8PLUS-72-2-US

BATTERY:  
(2) ENPHASE ENERGY ENCHARGE 10, 10.5KWH  
BRANCH DETAILS:  
4 BRANCH OF 11 MICRO INVERTERS(11 MODULES)

## ENGINEER OF RECORD

## CUSTOMER INFORMATION

NAME & ADDRESS:  
NICK SKATELL  
1565 CHICORA RD.,  
DUNN, NC 28334  
35°30'54.4"N 78°6'48.1"W

AHD: HARNETT COUNTY

UTILITY: DUKE ENERGY PROGRESS

## ENPHASE ENERGY ENCHARGE 10 SPECSHEET

PROJECT NUMBER:

DESIGNER/CHECKED BY:  
DM/

SCALE: AS NOTED PAPER SIZE: 17"x11"

DATE: 6/30/22 REV: A PV-6.3





**SYSTEM INFORMATION**

DC SYSTEM SIZE : 17380W  
 AC SYSTEM SIZE : 12760W  
 MODULES: (44) CANADIAN SOLAR CS1Y-395WS 395W  
 INVERTER: (44) ENPHASE IQ8PLUS-72-2-US  
 BATTERY: (2) ENPHASE ENERGY ENCHARGE 10, 10.5KWH  
 BRANCH DETAILS: 4 BRANCH OF 11 MICRO INVERTERS(11 MODULES)

**ENGINEER OF RECORD**

**CUSTOMER INFORMATION**

NAME & ADDRESS:  
 NICK SKATELL  
 1565 CHICORA RD.,  
 DUNN, NC 28334  
 35°30'54.4"N 78°67'48.1"W

AHD: HARNETT COUNTY

UTILITY: DUKE ENERGY PROGRESS

**RACKING SPECSHEET**

PROJECT NUMBER:

DESIGNER/CHECKED BY:  
 DM/

SCALE: AS NOTED PAPER SIZE: 17"x11"

DATE: 6/30/22

REV: A

PV-6.5

**S-5!**  
 The Right Way!

CorruBracket™ is extremely versatile. It can be used for almost any attachment need on 7/8" and 3/4" corrugated metal roofing. No messy sealants to apply. The factory-applied butyl sealant waterproofs and makes installation a snap!

Each CorruBracket™ comes with factory-applied butyl sealant in the base. CorruBracket is compatible with most common metal roofing materials. For design assistance, ask your distributor, or use our web-based calculator at [www.S-5.com](http://www.S-5.com) for job-specific system engineering and design of your next snow retention project. Also, please visit our website for more information including CAD details, metallurgical compatibilities and specifications.

The CorruBracket has been tested for load-to-failure results on wood decking and metal and wood purlins. The independent lab test data found at [www.S-5.com](http://www.S-5.com) can be used for load-critical designs and applications. S-5!® holding strength is unmatched in the industry.

**Example Profile**



**CorruBracket™**

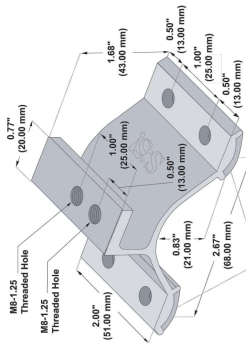

Factory-Applied Butyl

Please note, all measurements are provided to the nearest decimal place. Contact your distributor for information about hardware requirements.

**Example Applications**

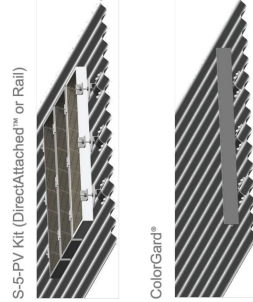

Distributed by

**S-5!® Warning! Please use this product responsibly!**  
 Products are protected by multiple U.S. and foreign patents. For published data regarding holding strength, bolt torque, patents and trademarks visit the S-5! website at [www.S-5.com](http://www.S-5.com).  
 S-5!® is a registered trademark of Sustainable Energy & Lighting Solutions, Inc. ©2022  
 S-5!® is a registered trademark of Sustainable Energy & Lighting Solutions, Inc. ©2022

**CorruBracket™**

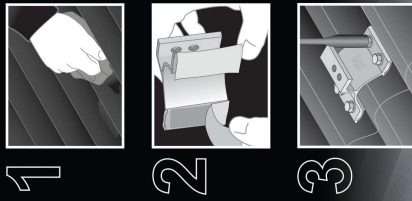

**S-5!**  
 The Right Way!

**CorruBracket™**

CorruBracket™ can be used to mount almost anything to corrugated metal roofing and is compatible with 7/8" and 3/4" corrugated roofing. No messy sealants to apply! No chance for leaks! The CorruBracket comes with factory-applied butyl sealant already in the base, and the S-5!® patented reservoir conceals the sealant, preventing UV degradation.

Installation is simple. CorruBracket is mounted directly into the supporting structure of the roof, i.e. roof decking, wood or steel purlins, or trusses. No surface preparation is necessary: simply wipe away excess oils and debris, peel the release paper, align, and apply. Secure through the pre-punched holes using the appropriate screws for the supporting structure.

CorruBracket is so strong, it will even support heavy-duty applications like snow retention. For corrugated profiles, the CorruBracket is the perfect match for our ColorGard® snow retention system. CorruBracket is economical and facilitates quick and easy installation.

The right way to attach almost anything to metal roofs!

**S-5!® CorruBracket™ is the right way to attach almost anything to 7/8" and 3/4" corrugated roofing, including PV via DirectAttached™ or rail methods.**

888-825-3432 | [www.S-5.com](http://www.S-5.com)