

© 2019 NC SOLAR NOW EXPRESSLY RESERVES ITS COMMON LAW COPYRIGHT AND OTHER PROPERTY RIGHTS IN THESE PLANS. THESE PLANS ARE NOT TO BE REPRODUCED, CHANGED OR COPIED IN ANY FORM OR MANNER WHATSOEVER, NOR ARE THEY TO BE ASSIGNED TO ANY THIRD PARTY WITHOUT FIRST OBTAINING THE EXPRESSED WRITTEN PERMISSION AND CONSENT OF NC SOLAR NOW.

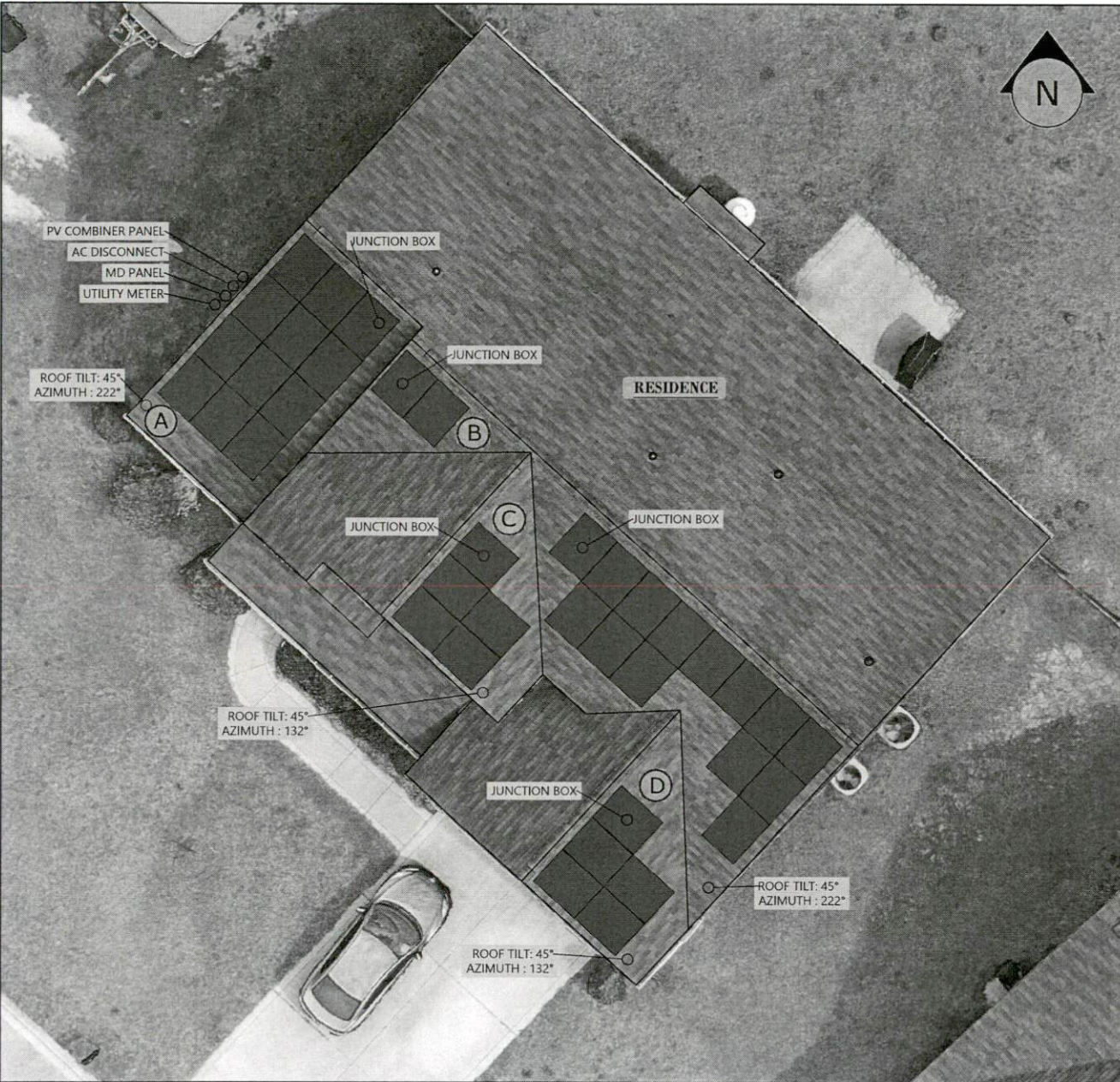

**PV MATERIAL SUMMARY: DISTRIBUTOR**

REC400AA PURE BLACK	38
IQ7A-72-2-US	38
X-IQ-AM1-240-4	1
Q-12-10-240	48
Q-SEAL-10	10
Q-TERM-10	7
XR-10-168B	16
XR-10-204B	6
XR10-BOSS-01-M1	2
UFO-CL-01-B1	102
UFO-STP-30MM-B1	52
XR-LUG-03-A1	14
4 IN QB1	70
QB DECK MOUNT 16317	24
MI-BHW	38
GC66803 Geocel Sealant	5
SOLADECK 0799-5B	5



**CLIENT INFO**

DARIN R MOON - 64 PITCH PINE CT  
64 PITCH PINE COURT  
SANFORD, NC 27332

**PROJECT INFO**

DC INPUT: 15,200 kW  
AC EXPORT: 13,262 kW  
DOI INSP. METHOD: OPTION 2

**CODE REFERENCES**

NATION ELECTRICAL CODE v. 2017  
NC FIRE PROTECTION CODE v. 2018  
NC BUILDING CODE v. 2018  
NC RESIDENTIAL CODE v. 2018  
ACSE v. 7-10

**SITE CONDITIONS**

WIND SPEED: 116 MPH  
RISK CATEGORY: II  
EXPOSURE: B  
SNOW: 10 PSF

**SHEET INDEX**

PV-1: COVER SHEET  
PV-2: PV STRUCTURAL  
PV-3: PV ELECTRICAL  
PV-4: PV EQUIPMENT LABELS  
PV-5: PV INSTALL GUIDE

**DESIGNER INFO**

DESIGNER: MCP  
ENGINEER: AWK  
DATE: 5/2/2022  
VERSION: P1

**PV SYSTEM COVER PAGE**

**PV-1.1**



© 2019 NC SOLAR NOW EXPRESSLY RESERVES ITS COMMON LAW COPYRIGHT AND OTHER PROPERTY RIGHTS IN THESE PLANS. THESE PLANS ARE NOT TO BE REPRODUCED, CHANGED OR COPIED IN ANY FORM OR MANNER WHATSOEVER, NOR ARE THEY TO BE ASSIGNED TO ANY THIRD PARTY WITHOUT FIRST OBTAINING THE EXPRESSED WRITTEN PERMISSION AND CONSENT OF NC SOLAR NOW.

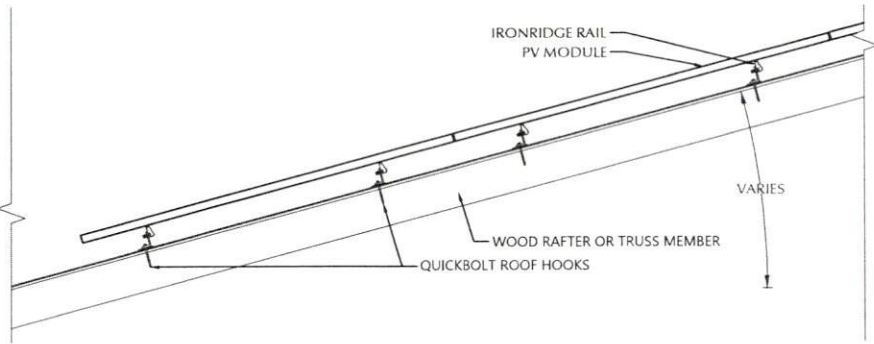

### STATEMENT OF STRUCTURAL COMPLIANCE

THE EXISTING ROOF STRUCTURE HAS BEEN DESIGNED TO SUPPORT THE ADDITIONAL LOADS OF THE PROPOSED PV SYSTEM. IN ADDITION, THE RACKING AND FASTENING SYSTEM SHALL BE CAPABLE OF SECURING THE SYSTEM TO THE STRUCTURE UNDER DESIGN CONDITIONS WHEN INSTALLED PROPERLY AND IN ACCORDANCE WITH THE RACKING AND FASTENING ARRANGEMENT DETAILED WITHIN THESE DRAWINGS.

NAME: ANDREW W. KING, PE  
 SIGNED: *Andrew W. King*

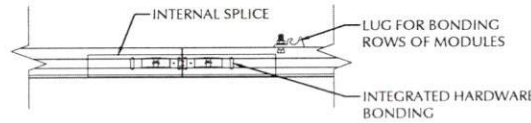

PV MODULES	
MAKE	REC
MODEL	REC400AA PURE BLACK
WIDTH	40.00 IN
LENGTH	71.70 IN
THICKNESS	30 MM
WEIGHT	45.00 LBS
ARRAY AREA	239 SQ.FT.
ARRAY WEIGHT	598 LBS

ROOF SUMMARY	
STRUCTURE TYPE	TRUSSES
MATERIAL	SOUTHERN PINE #2
SIZE	2 X 4
SPACING	24 IN O.C.
ALLOWABLE SPAN	88 IN
PITCH	12/12
DENSITY	30 LBS./CU.FT.
DECKING TYPE	OSB
MATERIAL	COMPOSITE
THICKNESS	7/16 IN
WEIGHT	1.60 LBS./SQ.FT.
ROOFING TYPE	ASPHALT SHINGLE
MATERIAL	ASPHALT
WEIGHT	2.30 LBS./SQ.FT.

ROOF MOUNT SUMMARY		
MAXIMUM (IN)	MOUNT SPACING	RAIL OVERHANG
WIND ZONE 1	72 IN	19 IN
WIND ZONE 2	48 IN	19 IN
WIND ZONE 3	48 IN	19 IN

ROOF LOADING	
GROUND SNOW LOAD	15 LBS./SQ.FT.
LIVE LOAD	20 LBS./SQ.FT.
DEAD LOAD	3.9 LBS./SQ.FT.
ROOFING	2.5 LBS./SQ.FT.
PV ARRAY	6.4 LBS./SQ.FT.
TOTAL	29.8 LBS./SQ.FT.
WIND LOAD:	
UPLIFT ZONE 1	-26.9 LBS./SQ.FT.
UPLIFT ZONE 2	-32.4 LBS./SQ.FT.
UPLIFT ZONE 3	-32.4 LBS./SQ.FT.
DOWNWARD	24.7 LBS./SQ.FT.
FASTENER LOAD:	
UPLIFT ZONE 1	-479 LBS.
UPLIFT ZONE 2	-385 LBS.
UPLIFT ZONE 3	-385 LBS.
DOWNWARD	440 LBS.

ROOF MOUNT & FASTENER	
ROOF MOUNT:	QUICKBOLT
MAKE	4 IN QBT
MODEL	STAINLESS / EPDM
MATERIAL	
FASTENER:	QUICK SCREWS
MAKE	HANGER BOLT
MODEL	304 SS
MATERIAL	
SIZE	5/16-18 X 5-1/4"
GENERAL:	
WEIGHT	0.56 LBS
FASTENERS PER MOUNT	1
MAX. PULL-OUT FORCE	960 LBS
SAFETY FACTOR	2
DESIGN PULL-OUT FORCE	480.0 LBS

MOUNTING RAILS	
MAKE	IRONRIDGE
MODEL	XR10
MATERIAL	ALUMINUM
WEIGHT	0.425 LBS/IN
SPACING	36 IN

**ALTERNATIVE ATTACHMENT**  
 MAY BE USED WHERE STRUCTURAL MEMBERS ARE NOT ACCESSIBLE

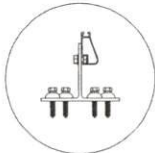

### ROOF MOUNT & FASTENER

ROOF MOUNT:	
MAKE	QUICKBOLT
MODEL	QB DECK MOUNT 16317
MATERIAL	STAINLESS / EPDM
FASTENER:	QUICK SCREWS
MAKE	HEX LAG PN# 16318
MODEL	304 SS
MATERIAL	
SIZE	5/16" X 1-3/4"
GENERAL:	
WEIGHT	0.8819
FASTENERS PER MOUNT	4
MAX. PULL-OUT FORCE	705.0 LBS
SAFETY FACTOR	3
DESIGN PULL-OUT FORCE	235.0 LBS

### ROOF MOUNT SUMMARY

MAXIMUM (IN)	MOUNT SPACING	RAIL OVERHANG
WIND ZONE 1	35 IN	29 IN
WIND ZONE 2	26 IN	10 IN
WIND ZONE 3	24 IN	9 IN

### ROOF LOADING

FASTENER LOAD:	
UPLIFT ZONE 1	-233 LBS.
UPLIFT ZONE 2	-208 LBS.
UPLIFT ZONE 3	-192 LBS.
DOWNWARD	214 LBS.

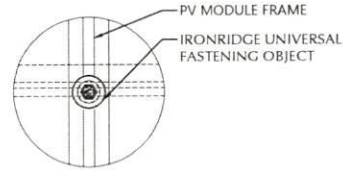
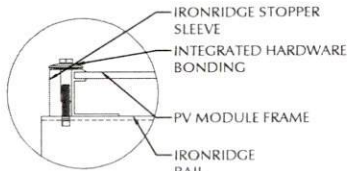
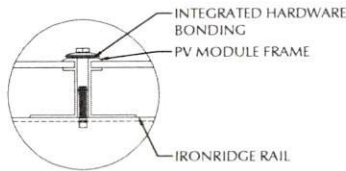

### 1 ROOF FASTENER DETAIL NOT TO SCALE

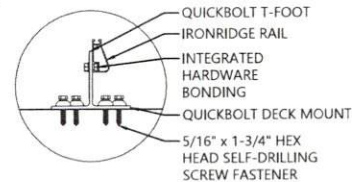
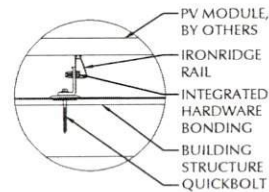
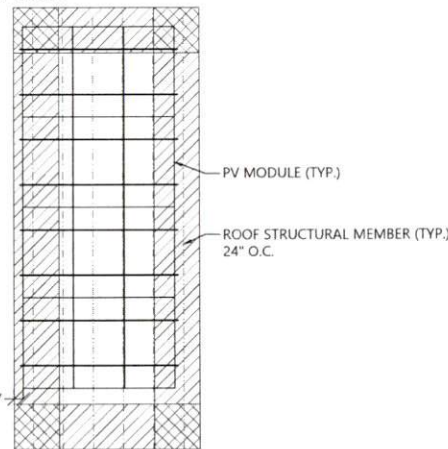

### 2 ROOF ARRAY LAYOUT 1/8" = 1'-0"

# NC SOLAR NOW



### CLIENT INFO

DARIN R MOON - 64 PITCH PINE CT  
 64 PITCH PINE COURT  
 SANFORD, NC 27332

### PROJECT INFO

DC INPUT: 15,200 kW  
 AC EXPORT: 13,262 kW  
 DOI INSPT. METHOD: OPTION 2

### CODE REFERENCES

NATION ELECTRICAL CODE v. 2017  
 NC FIRE PROTECTION CODE v. 2018  
 NC BUILDING CODE v. 2018  
 NC RESIDENTIAL CODE v. 2018  
 ACSE v. 7-10

### SITE CONDITIONS

WIND SPEED: 116 MPH  
 RISK CATEGORY: II  
 EXPOSURE: B  
 SNOW: 10 PSF

### SHEET INDEX

PV-1 COVER SHEET  
 PV-2 PV STRUCTURAL  
 PV-3 PV ELECTRICAL  
 PV-4 PV EQUIPMENT LABELS  
 PV-5 PV INSTALL GUIDE

### DESIGNER INFO

DESIGNER: MCP  
 ENGINEER: AWK  
 DATE: 5/2/2022  
 VERSION: P1

### PV SYSTEM STRUCTURAL

# PV-2.1

© 2018 NC SOLAR NOW EXPRESSLY RESERVES ITS COMMON LAW COPYRIGHT AND OTHER PROPERTY RIGHTS IN THESE PLANS. THESE PLANS ARE NOT TO BE REPRODUCED, CHANGED OR COPIED IN ANY FORM OR MANNER WHATSOEVER, NOR ARE THEY TO BE ASSIGNED TO ANY THIRD PARTY WITHOUT FIRST OBTAINING THE EXPRESSED WRITTEN PERMISSION AND CONSENT OF NC SOLAR NOW.

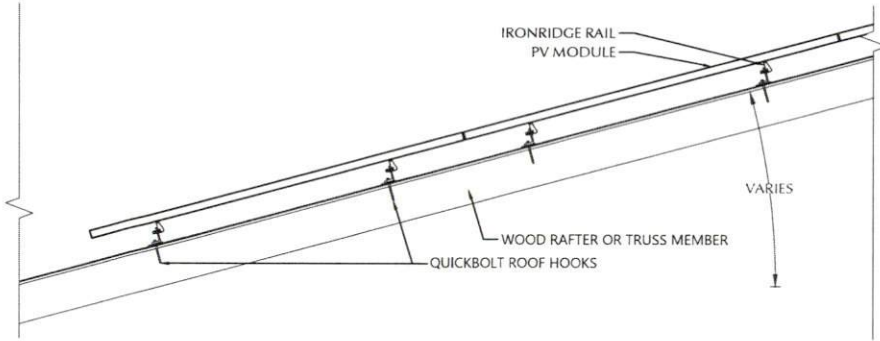

**STATEMENT OF STRUCTURAL COMPLIANCE**

THE EXISTING ROOF STRUCTURE HAS BEEN DESIGNED TO SUPPORT THE ADDITIONAL LOADS OF THE PROPOSED PV SYSTEM. IN ADDITION, THE RACKING AND FASTENING SYSTEM SHALL BE CAPABLE OF SECURING THE SYSTEM TO THE STRUCTURE UNDER DESIGN CONDITIONS WHEN INSTALLED PROPERLY AND IN ACCORDANCE WITH THE RACKING AND FASTENING ARRANGEMENT DETAILED WITHIN THESE DRAWINGS.

NAME: ANDREW W. KING, PE  
 SIGNED: *Andrew W. King*

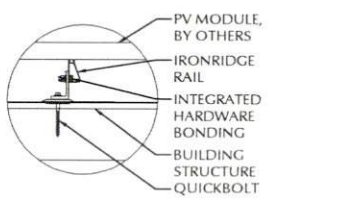
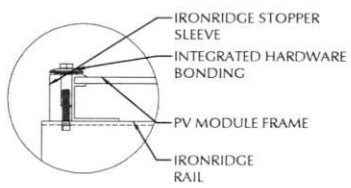
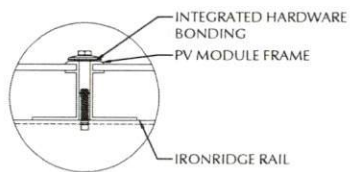
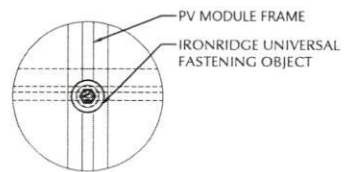
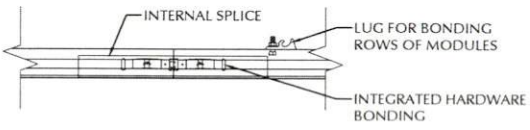

**1** ROOF FASTENER DETAIL  
NOT TO SCALE

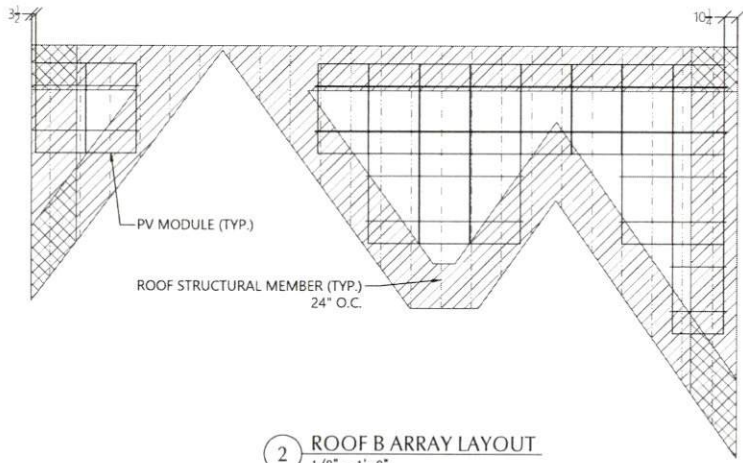

**2** ROOF B ARRAY LAYOUT  
1/8" = 1'-0"

PV MODULES	
MAKE	REC
MODEL	REC400AA PURE BLACK
WIDTH	40.00 IN
LENGTH	71.70 IN
THICKNESS	30 MM
WEIGHT	45.00 LBS.
ARRAY AREA	379 SQ.FT.
ARRAY WEIGHT	797 LBS.

ROOF SUMMARY	
STRUCTURE	TRUSSES
TYPE	2 X 4
MATERIAL	SOUTHERN PINE #2
SIZE	24 IN O.C.
ALLOWABLE SPAN	86 IN
PITCH	12/12
DENSITY	30 LBS./CU.FT.
DECKING	OSB
TYPE	COMPOSITE
MATERIAL THICKNESS	7/16 IN
WEIGHT	1.60 LBS./SQ.FT.
ROOFING	ASPHALT SHINGLE
TYPE	ASPHALT
MATERIAL	2.30 LBS./SQ.FT.

ROOF MOUNT SUMMARY		
MAXIMUM (IN)	MOUNT SPACING	RAIL OVERHANG
WIND ZONE 1	72 IN	19 IN
WIND ZONE 2	48 IN	19 IN
WIND ZONE 3	48 IN	19 IN

ROOF LOADING	
GROUND SNOW LOAD:	15 LBS./SQ.FT.
LIVE LOAD	20 LBS./SQ.FT.
DEAD LOAD	
ROOFING	3.9 LBS./SQ.FT.
PV ARRAY	2.5 LBS./SQ.FT.
TOTAL	6.4 LBS./SQ.FT.
WIND LOAD:	
UPLIFT ZONE 1	-26.9 LBS./SQ.FT.
UPLIFT ZONE 2	-32.4 LBS./SQ.FT.
UPLIFT ZONE 3	-32.4 LBS./SQ.FT.
DOWNWARD	24.7 LBS./SQ.FT.
FASTENER LOAD:	
UPLIFT ZONE 1	-479 LBS.
UPLIFT ZONE 2	-385 LBS.
UPLIFT ZONE 3	-385 LBS.
DOWNWARD	440 LBS.

ROOF MOUNT & FASTENER	
ROOF MOUNT:	
MAKE	QUICKBOLT
MODEL	4 IN QB1
MATERIAL	STAINLESS / EPDM
FASTENER:	
MAKE	QUICK SCREWS
MODEL	HANGER BOLT
MATERIAL	304 SS
SIZE	3/16-18 X 5-1/4"
GENERAL:	
WEIGHT	0.56 LBS.
FASTENERS PER MOUNT	1
MAX. PULL-OUT FORCE	960.0 LBS.
SAFETY FACTOR	2
DESIGN PULL-OUT FORCE	480.0 LBS.

MOUNTING RAILS	
MAKE	IRONRIDGE
MODEL	XR10
MATERIAL	ALUMINUM
WEIGHT	0.425 LBS/IN
SPACING	36 IN

**NC SOLAR NOW**

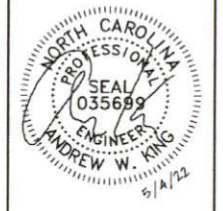

**CLIENT INFO**  
 DARIN R MOON - 64 PITCH PINE CT  
 64 PITCH PINE COURT  
 SANFORD, NC 27332

**PROJECT INFO**  
 DC INPUT: 15,200 kW  
 AC EXPORT: 13,262 kW  
 DOI INSP. METHOD: OPTION 2

**CODE REFERENCES**  
 NATION ELECTRICAL CODE v. 2017  
 NC FIRE PROTECTION CODE v. 2018  
 NC BUILDING CODE v. 2018  
 NC RESIDENTIAL CODE v. 2018  
 ACSE v. 7-10

**SITE CONDITIONS**  
 WIND SPEED: 116 MPH  
 RISK CATEGORY: II  
 EXPOSURE: B  
 SNOW: 10 PSF

**SHEET INDEX**  
 PV-1: COVER SHEET  
 PV-2: PV STRUCTURAL  
 PV-3: PV ELECTRICAL  
 PV-4: PV EQUIPMENT LABELS  
 PV-5: PV INSTALL GUIDE

**DESIGNER INFO**  
 DESIGNER: MCP  
 ENGINEER: AWK  
 DATE: 5/2/2022  
 VERSION: P1

**PV SYSTEM STRUCTURAL**

**PV-2.2**

© 2019 NC SOLAR NOW EXPRESSLY RESERVES ITS COMMON LAW COPYRIGHT AND OTHER PROPERTY RIGHTS IN THESE PLANS. THESE PLANS ARE NOT TO BE REPRODUCED, CHANGED OR COPIED IN ANY FORM OR MANNER WHATSOEVER, NOR ARE THEY TO BE ASSIGNED TO ANY THIRD PARTY WITHOUT FIRST OBTAINING THE EXPRESSED WRITTEN PERMISSION AND CONSENT OF NC SOLAR NOW.

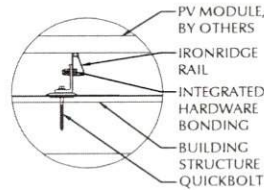
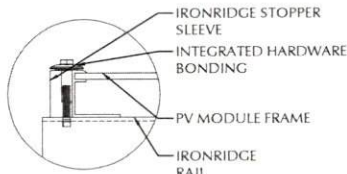
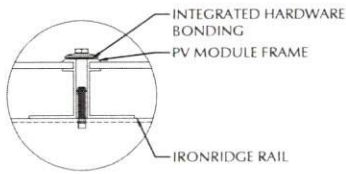
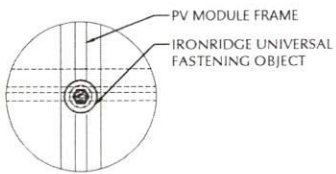
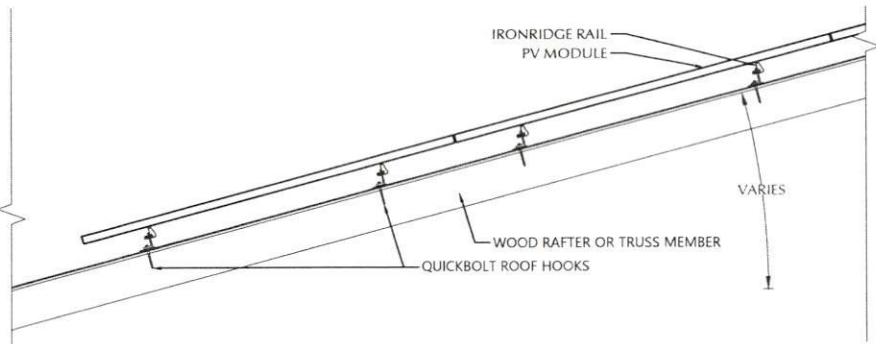

1 ROOF FASTENER DETAIL  
NOT TO SCALE

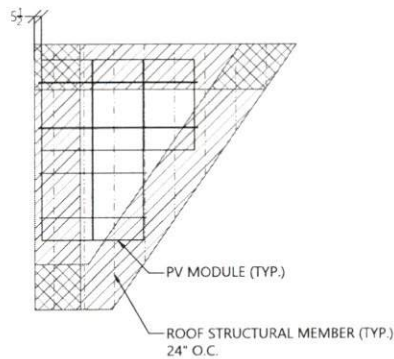

2 ROOF C ARRAY LAYOUT  
1/8" = 1'-0"

**STATEMENT OF STRUCTURAL COMPLIANCE**

THE EXISTING ROOF STRUCTURE HAS BEEN DESIGNED TO SUPPORT THE ADDITIONAL LOADS OF THE PROPOSED PV SYSTEM. IN ADDITION, THE RACKING AND FASTENING SYSTEM SHALL BE CAPABLE OF SECURING THE SYSTEM TO THE STRUCTURE UNDER DESIGN CONDITIONS WHEN INSTALLED PROPERLY AND IN ACCORDANCE WITH THE RACKING AND FASTENING ARRANGEMENT DETAILED WITHIN THESE DRAWINGS.

NAME: ANDREW W. KING, PE  
SIGNED: *Andrew W. King*

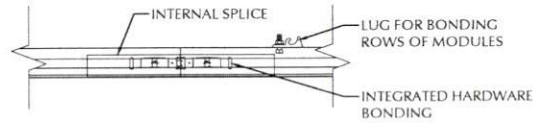

PV MODULES	
MAKE	REC
MODEL	REC400AA PURE BLACK
WIDTH	40.00 IN
LENGTH	71.70 IN
THICKNESS	30 MM
WEIGHT	45.00 LBS
ARRAY AREA	100 SQFT
ARRAY WEIGHT	249 LBS

ROOF SUMMARY	
STRUCTURE TYPE	TRUSSES
MATERIAL	SOUTHERN PINE #2
SIZE	2 X 4
SPACING	24 IN O.C.
ALLOWABLE SPAN	88 IN
PITCH	12/12
DENSITY	30 LBS./CU.FT.
DECKING TYPE	OSB
MATERIAL	COMPOSITE
THICKNESS	7/16 IN
WEIGHT	1.60 LBS./SQFT
ROOFING TYPE	ASPHALT SHINGLE
MATERIAL	ASPHALT
WEIGHT	2.30 LBS./SQFT.

ROOF MOUNT SUMMARY			
MAXIMUM (IN)	MOUNT SPACING	RAIL OVERHANG	
WIND ZONE 1	72 IN	19 IN	
WIND ZONE 2	48 IN	19 IN	
WIND ZONE 3	48 IN	19 IN	

ROOF LOADING	
GROUND SNOW LOAD	15 LBS./SQFT
LIVE LOAD	20 LBS./SQFT
DEAD LOAD	
ROOFING	3.9 LBS./SQFT
PV ARRAY	2.5 LBS./SQFT
TOTAL	6.4 LBS./SQFT
WIND LOAD:	
UPLIFT ZONE 1	-26.9 LBS./SQFT
UPLIFT ZONE 2	-32.4 LBS./SQFT
UPLIFT ZONE 3	-32.4 LBS./SQFT
DOWNWARD	24.7 LBS./SQFT
FASTENER LOAD:	
UPLIFT ZONE 1	-479 LBS
UPLIFT ZONE 2	-385 LBS
UPLIFT ZONE 3	-385 LBS
DOWNWARD	440 LBS

ROOF MOUNT & FASTENER	
ROOF MOUNT:	
MAKE	QUICKBOLT
MODEL	4 IN QB1
MATERIAL	STAINLESS / EPDM
FASTENER:	
MAKE	QUICK SCREWS
MODEL	HANGER BOLT
MATERIAL	304 SS
SIZE	5/16-18 X 5-1/4"
GENERAL:	
WEIGHT	0.56 LBS.
FASTENERS PER MOUNT	1
MAX. PULL-OUT FORCE	960.0 LBS.
SAFETY FACTOR	2
DESIGN PULL-OUT FORCE	480.0 LBS.

MOUNTING RAILS	
MAKE	IRONRIDGE
MODEL	XR10
MATERIAL	ALUMINUM
WEIGHT	0.425 LBS/IN
SPACING	36 IN

**NC SOLAR NOW**



**CLIENT INFO**  
DARIN R MOON - 64 PITCH PINE CT  
64 PITCH PINE COURT  
SANFORD, NC 27332

**PROJECT INFO**  
DC INPUT: 15,200 kW  
AC EXPORT: 13,262 kW  
DOI INSPT. METHOD: OPTION 2

**CODE REFERENCES**  
NATIONAL ELECTRICAL CODE v. 2017  
NC FIRE PROTECTION CODE v. 2018  
NC BUILDING CODE v. 2018  
NC RESIDENTIAL CODE v. 2018  
ACSE v. 7-10

**SITE CONDITIONS**  
WIND SPEED: 116 MPH  
RISK CATEGORY: II  
EXPOSURE: B  
SNOW: 10 PSF

**SHEET INDEX**  
PV-1 COVER SHEET  
PV-2 PV STRUCTURAL  
PV-3 PV ELECTRICAL  
PV-4 PV EQUIPMENT LABELS  
PV-5 PV INSTALL GUIDE

**DESIGNER INFO**  
DESIGNER: MCP  
ENGINEER: AWK  
DATE: 5/2/2022  
VERSION: P1

**PV SYSTEM STRUCTURAL**

**PV-2.3**

© 2018 NC SOLAR NOW EXPRESSLY RESERVES ITS COMMON LAW COPYRIGHT AND OTHER PROPERTY RIGHTS IN THESE PLANS. THESE PLANS ARE NOT TO BE REPRODUCED, CHANGED OR COPIED IN ANY FORM OR MANNER WHATSOEVER, NOR ARE THEY TO BE ASSIGNED TO ANY THIRD PARTY WITHOUT FIRST OBTAINING THE EXPRESSED WRITTEN PERMISSION AND CONSENT OF NC SOLAR NOW.

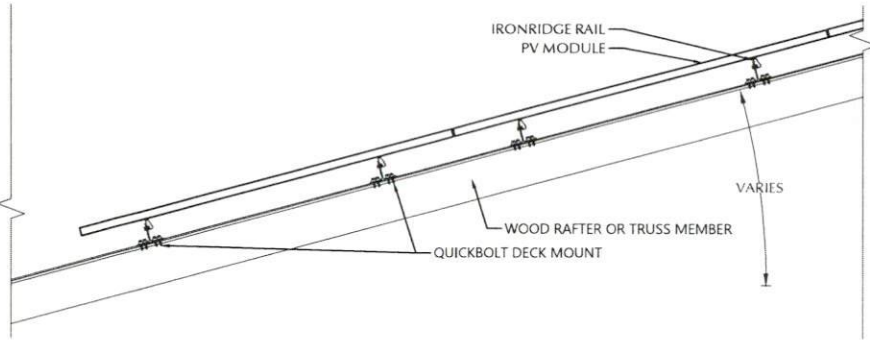

**STATEMENT OF STRUCTURAL COMPLIANCE**

THE EXISTING ROOF STRUCTURE HAS BEEN DESIGNED TO SUPPORT THE ADDITIONAL LOADS OF THE PROPOSED PV SYSTEM. IN ADDITION, THE RACKING AND FASTENING SYSTEM SHALL BE CAPABLE OF SECURING THE SYSTEM TO THE STRUCTURE UNDER DESIGN CONDITIONS WHEN INSTALLED PROPERLY AND IN ACCORDANCE WITH THE RACKING AND FASTENING ARRANGEMENT DETAILED WITHIN THESE DRAWINGS.

NAME: ANDREW W. KING, PE  
 SIGNED: *Andrew W. King*

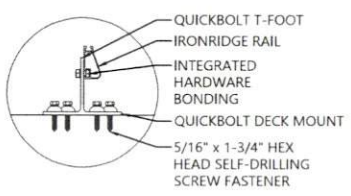
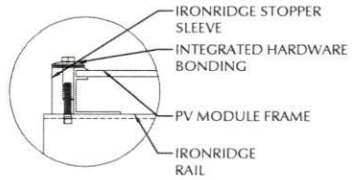
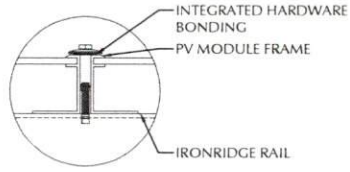
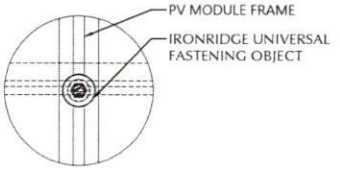
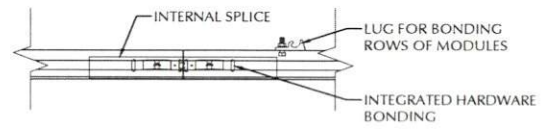

**1** ROOF FASTENER DETAIL  
NOT TO SCALE

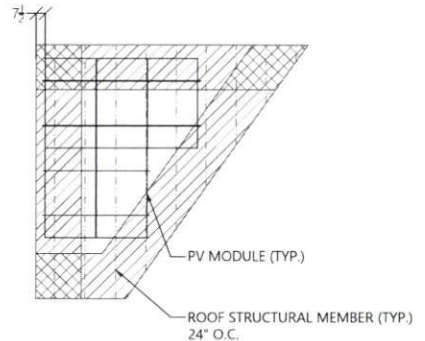

**2** ROOF D ARRAY LAYOUT  
1/8" = 1'-0"

PV MODULES	
MAKE	REC
MODEL	REC400AA PURE BLACK
WIDTH	40.00 IN
LENGTH	71.70 IN
THICKNESS	30 MM
WEIGHT	45.00 LBS
ARRAY AREA	100 SQ.FT.
ARRAY WEIGHT	249 LBS

ROOF SUMMARY	
STRUCTURE	TRUSSES
TYPE	SOUTHERN PINE #2
MATERIAL	2 X 4
SIZE	24 IN O.C.
SPACING	88 IN
ALLOWABLE SPAN	12/12
PITCH	30 LBS./CU.FT.
DENSITY	OSB
DECKING	COMPOSITE
TYPE	7/16 IN
MATERIAL	1.60 LBS./SQFT
THICKNESS	ASPHALT SHINGLE
WEIGHT	ASPHALT
ROOFING	2.30 LBS./SQFT
TYPE	
MATERIAL	
WEIGHT	

ROOF MOUNT SUMMARY			
MAXIMUM (IN)	MOUNT SPACING	RAIL OVERHANG	
WIND ZONE 1	35 IN	14 IN	
WIND ZONE 2	26 IN	10 IN	
WIND ZONE 3	24 IN	9 IN	

ROOF LOADING	
GROUND SNOW LOAD:	15 LBS./SQFT
LIVE LOAD:	20 LBS./SQFT
DEAD LOAD:	
ROOFING:	3.91 LBS./SQFT
PV ARRAY:	2.51 LBS./SQFT
TOTAL:	6.4 LBS./SQFT
WIND LOAD:	
UPLIFT ZONE 1:	-26.9 LBS./SQFT
UPLIFT ZONE 2:	-32.4 LBS./SQFT
UPLIFT ZONE 3:	-32.4 LBS./SQFT
DOWNWARD:	24.7 LBS./SQFT
FASTENER LOAD:	
UPLIFT ZONE 1:	-233 LBS
UPLIFT ZONE 2:	-209 LBS
UPLIFT ZONE 3:	-193 LBS
DOWNWARD:	214 LBS

ROOF MOUNT & FASTENER	
ROOF MOUNT:	QUICKBOLT
MAKE	Q8 DECK MOUNT 16317
MODEL	STAINLESS / EPDM
MATERIAL	FASTENER:
FASTENER:	QUICK SCREWS
MAKE	HEX LAG P#16318
MODEL	304 SS
MATERIAL	SIZE
FASTENERS PER MOUNT:	4
MAX. PULL-OUT FORCE:	705.0 LBS
SAFETY FACTOR:	3
DESIGN PULL-OUT FORCE:	235.0 LBS

MOUNTING RAILS	
MAKE	IRONRIDGE
MODEL	XR10
MATERIAL	ALUMINUM
WEIGHT	0.425 LBS/IN
SPACING	36 IN

**NC SOLAR NOW**



**CLIENT INFO**  
 DARIN R MOON - 64 PITCH PINE CT  
 64 PITCH PINE COURT  
 SANFORD, NC 27332

**PROJECT INFO**  
 DC INPUT: 15,200 kW  
 AC EXPORT: 13,262 kW  
 DOI INPUT METHOD: OPTION 2

**CODE REFERENCES**  
 NATION ELECTRICAL CODE v. 2017  
 NC FIRE PROTECTION CODE v. 2018  
 NC BUILDING CODE v. 2018  
 NC RESIDENTIAL CODE v. 2018  
 ACSE v. 7-10

**SITE CONDITIONS**  
 WIND SPEED: 116 MPH  
 RISK CATEGORY: II  
 EXPOSURE: B  
 SNOW: 10 PSF

**SHEET INDEX**  
 PV-1: COVER SHEET  
 PV-2: PV STRUCTURAL  
 PV-3: PV ELECTRICAL  
 PV-4: PV EQUIPMENT LABELS  
 PV-5: PV INSTALL GUIDE

**DESIGNER INFO**  
 DESIGNER: MCP  
 ENGINEER: AWK  
 DATE: 5/2/2022  
 VERSION: P1

**PV SYSTEM STRUCTURAL**

**PV-2.4**

© 2019 NC SOLAR NOW EXPRESSLY RESERVES ITS COMMON LAW COPYRIGHT AND OTHER PROPERTY RIGHTS IN THESE PLANS. THESE PLANS ARE NOT TO BE REPRODUCED, CHANGED OR COPIED IN ANY FORM OR MANNER WHATSOEVER, NOR ARE THEY TO BE ASSIGNED TO ANY THIRD PARTY WITHOUT FIRST OBTAINING THE EXPRESSED WRITTEN PERMISSION AND CONSENT OF NC SOLAR NOW.

CONDUCTOR SCHEDULE										
TAG	CURRENT CARRYING CONDUCTORS			GROUNDING CONDUCTORS			CONDUIT/RACEWAY		NOTES	
	QTY.	SIZE	INSULATION	QTY.	SIZE	INSULATION	QTY.	SIZE		LOCATION
C1	8	10 AWG	DG CABLE	1	6 AWG	BARE	-	-	FREE AIR	1
C2	8	10 AWG	THWN	1	10 AWG	THWN	2	3/4"	EXT/INT	2,4
C3	3	4 AWG	THWN	1	8 AWG	THWN	1	1"	EXTERIOR	2,4
C4	3	4 AWG	THWN	-	-	-	1	1"	EXTERIOR	2,4
C5	3	40 AWG ALUMINUM	XHHW	-	-	-	1	2"	EXTERIOR	2,4
XC	-	-	-	-	-	-	-	-	-	3

**NOTES:**

1. MANUFACTURER PROVIDED, UL LISTED WIRING HARNESS FOR USE ON EXPOSED ROOFS
2. CONDUIT SIZE SHOWN IS CODE MINIMUM. LARGER SIZES ARE ALLOWED.
3. EXISTING CONDUCTORS, FIELD VERIFY
4. EQUIPMENT TERMINAL RATING SHALL BE A MINIMUM OF 75°C AT BOTH END OF CONDUCTOR

PV MODULE	
MAKE	REC
MODEL	REC400AA PURE BLACK
NOM. POWER (PNOM)	400 WATTS
NOM. VOLT. (VMPP)	42.1 VOLTS
O.C. VOLT. (VOC)	48.8 VOLTS
MAX. SYS. VOLT.	1000 VOLTS
NOM. CURR. (IMPP)	9.5 AMPS
S.C. CURR. (ISC)	10.3 AMPS
TEMP. COEF. (PMPP)	-0.26 %/°C
TEMP. COEF. (Voc)	-0.24 %/°C
MAX. SERIES FUSE	25 AMPS
UL LIST. (Y/N)	YES

PV COMBINER PANEL	
MAKE	ENPHASE
MODEL	X-IQ-AMT-240-4
INPLT.	NA
MAX BRANCH CIRCUITS	4 TOTAL
BRANCH CIRCUIT (OCPD)	30 AMPS
OUTPUT	15600 WATTS
MAX POWER	240 VOLTS
NOM. VOLTAGE	125 AMPS
BUS RATING	NO
MAIN BREAKER (Y/N)	NEMA TYPE 3R
ENCL. RATING	YES
UL LIST. (Y/N)	YES

DC / AC INVERTER	
MAKE	ENPHASE
MODEL	IQ7A-72-3-US
DC INPLT.	295-460
POWER RANGE (WATTS)	33-58
MIN/MAX START VOLT.	18-58
OPERATING VOLT. RANGE	15 AMPS
MAX. CURRENT	60, 66, & 72 CELL
MODULE COMPATIBILITY	AC OUTPUT
AC OUTPUT	366 WATTS
MAX. POWER	349 WATTS
NOM. POWER	211-240-264
NOM. VOLT.	1.45 AMPS
MAX. CURR.	NO
DC DISC. (Y/N)	YES
RAPID SHUTDOWN (Y/N)	NEMA TYPE 6
PROTECT. RATING	YES
UL LIST. (Y/N)	YES
MAX BRANCH CIRCUIT	11

UTILITY METER (NEW)	
MAKE	MILBANK
MODEL	OUTD-LAN LUT417-XGF
ENCL. RATING	NEMA 3R
VOLT. RATING	240 VOLTS
BUS RATING	200 AMPS
UL LIST. (Y/N)	YES

JUNCTION BOX	
MAKE	SOLADECK
PROTECT. RATING	NEMA TYPE 3R
UL LIST. (Y/N)	YES

MD PANEL (NEW)	
MAKE	GENERIC
MODEL	NA
ENCL. RATING	NEMA 3R
VOLT. RATING	240 VOLTS
BUS RATING	200 AMPS
UL LIST. (Y/N)	YES
MAIN BREAKER (Y/N)	YES
MAIN BREAKER RATING	200 AMPS

AC DISCONNECT	
MAKE	GENERIC
MODEL	NA
ENCL. RATING	NEMA 3R
VOLT. RATING	240 VOLTS
AMP RATING	100 AMPS
UL LIST. (Y/N)	YES
FUSED (Y/N)	YES
FUSE RATING	70 A

- REMOVE EXISTING METER COMBO PANEL AND REPLACE WITH METER BASE THAT FEEDS NEW MD PANEL.

- BACK-FEED SOLAR OUTPUT VIA SUPPLY SIDE TAP INSIDE OF MD PANEL
- FEED EXISTING SUB PANEL VIA FEED-THROUGH LUGS

- LOAD-BREAK RATED
- VISIBLE OPEN
- LOCKABLE IN OPEN POSITION
- INSTALL ADJACENT TO METER
- DISCONNECT TO BE READILY ACCESSIBLE TO UTILITY COMPANY PERSONNEL AT ALL TIMES
- SERVICE RATED
- PROVIDE NEUTRAL/GROUND BONDING JUMPER

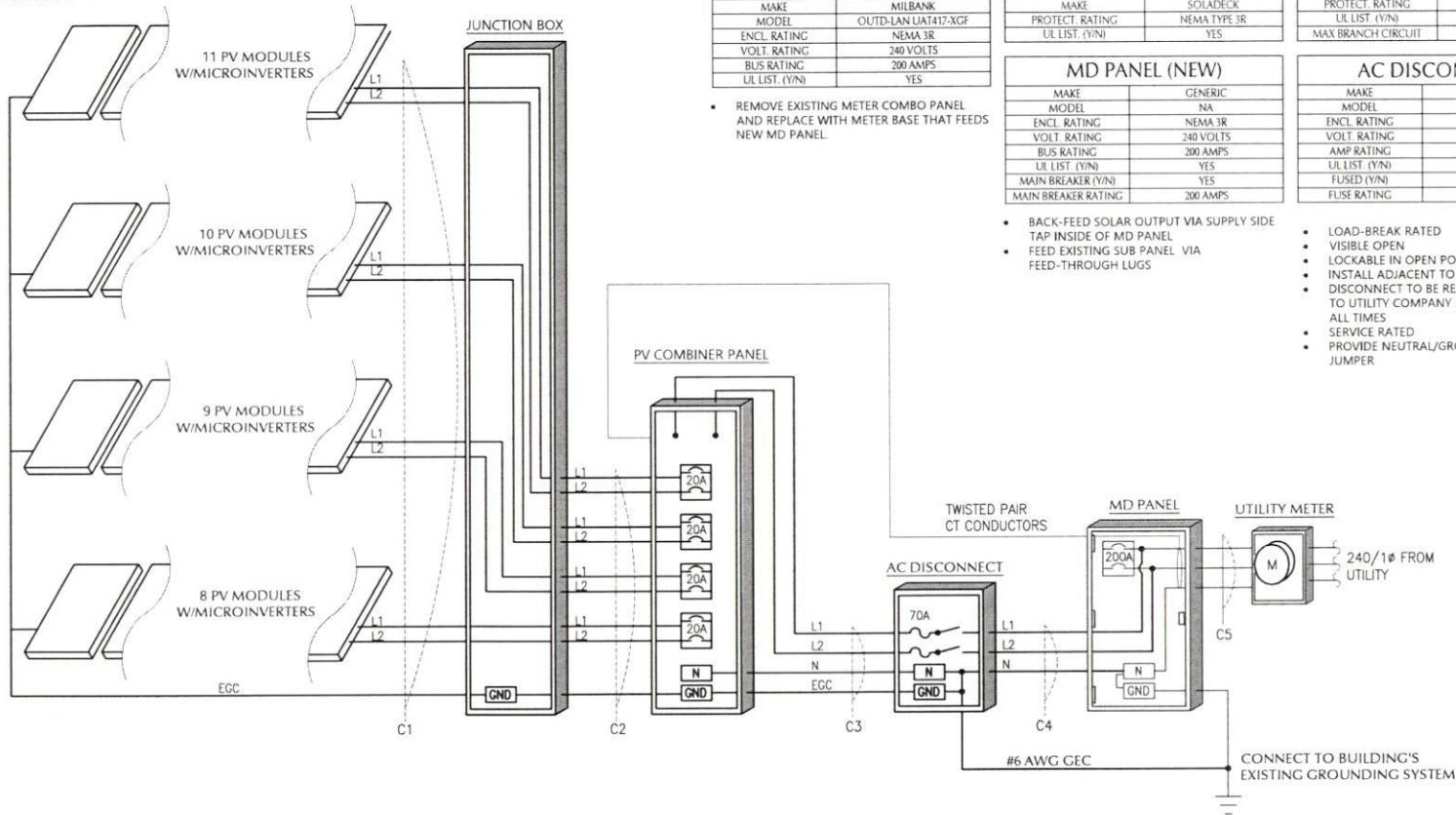

1 ELECTRICAL SCHEMATIC  
NTS

NC  
SOLAR  
NOW



**CLIENT INFO**

DARIN R MOON - 64 PITCH PINE CT  
64 PITCH PINE COURT  
SANFORD, NC 27332

**PROJECT INFO**

DC INPLT. 15,200 kW  
AC EXPORT. 13,262 kW  
DOI INSP. METHOD. OPTION 2

**CODE REFERENCES**

NATION ELECTRICAL CODE v. 2017  
NC FIRE PROTECTION CODE v. 2018  
NC BUILDING CODE v. 2018  
NC RESIDENTIAL CODE v. 2018  
ACSE v. 7-10

**SITE CONDITIONS**

WIND SPEED: 116 MPH  
RISK CATEGORY: II  
EXPOSURE: B  
SNOW: 10 PSF

**SHEET INDEX**

PV-1 COVER SHEET  
PV-2 PV STRUCTURAL  
PV-3 PV ELECTRICAL  
PV-4 PV EQUIPMENT LABELS  
PV-5 PV INSTALL GUIDE

**DESIGNER INFO**

DESIGNER MCP  
ENGINEER AWK  
DATE 5/2/2022  
VERSION P1

PV SYSTEM  
ELECTRICAL

PV-3.1

© 2018 NC SOLAR NOW EXPRESSLY RESERVES ITS COMMON LAW COPYRIGHT AND OTHER PROPERTY RIGHTS IN THESE PLANS. THESE PLANS ARE NOT TO BE REPRODUCED, CHANGED OR COPIED IN ANY FORM OR MANNER WHATSOEVER, NOR ARE THEY TO BE ASSIGNED TO ANY THIRD PARTY WITHOUT FIRST OBTAINING THE EXPRESSED WRITTEN PERMISSION AND CONSENT OF NC SOLAR NOW.

**⚠ WARNING**  
ELECTRIC SHOCK HAZARD  
TERMINALS ON THE LINE AND LOAD SIDES MAY BE ENERGIZED IN THE OPEN POSITION

NEC 606.13 (B)  
PLACE ON PV SYSTEM DISCONNECTING MEANS

**⚠ WARNING**  
POWER SOURCE OUTPUT CONNECTION DO NOT RELOCATE THIS OVERCURRENT DEVICE

NEC 705.12 (B)(3)(b)  
PLACE ADJACENT TO BACK-FED BREAKER

**⚠ WARNING**  
DUAL POWER SUPPLY  
SOURCES: UTILITY GRID AND PV SOLAR ELECTRIC SYSTEM

NEC 705.12 (B)(3)  
PLACE ON ALL EQUIPMENT THAT IS SUPPLIED BY BOTH POWER SOURCES

**WARNING: PHOTOVOLTAIC POWER SOURCE**

NEC 690.31 (G)(3)(b)(4)  
PLACE ON ALL JUNCTION BOXES, EXPOSED RACEWAYS, AND OTHER WIRING METHODS EVERY 10' AND ON EVERY SECTION SEPARATED BY ENCLOSURES, WALLS, PARTITIONS, CEILING, OR FLOORS.

**RAPID SHUTDOWN SWITCH FOR SOLAR PV SYSTEM**

NEC 690.56 (C)(3)  
PLACE ON RAPID SHUTDOWN SWITCH OR EQUIPMENT WITH INTEGRATED RAPID SHUTDOWN \*REFLECTIVE\*

**SOLAR PV SYSTEM EQUIPPED WITH RAPID SHUTDOWN**

TURN RAPID SHUTDOWN SWITCH TO THE "OFF" POSITION TO SHUT DOWN PV SYSTEM AND REDUCE SHOCK HAZARD IN THE ARRAY

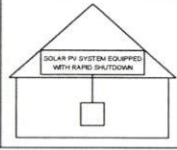

NEC 690.56 (C)(3)(a)  
PLACE WITHIN 3FT OF SERVICE DISCONNECTING MEANS TO WHICH THE PV SYSTEMS ARE CONNECTED AND SHALL INDICATE THE LOCATIONS OF RAPID SHUTDOWN SWITCHES

**PHOTOVOLTAIC POWER SOURCE**  
OPERATING AC VOLTAGE 240 V  
MAXIMUM OPERATING AC OUTPUT CURRENT 55.1 A

NEC 690.54  
PLACE ON INTERCONNECTION DISCONNECTING MEANS

**PV SYSTEM DISCONNECT**

NEC 606.13 (B)  
PLACE ON PV SYSTEM DISCONNECTING MEANS

**⚠ WARNING**  
THIS EQUIPMENT FED BY MULTIPLE SOURCES. TOTAL RATING OF ALL OVERCURRENT DEVICES EXCLUDING MAIN SUPPLY OVERCURRENT DEVICE SHALL NOT EXCEED AMPACITY OF BUSBAR.

NEC 705.12 (B)(2)(3)(a)  
PLACE ON PV COMBINER PANEL

SERVICE DISCONNECT LOCATED:  
NORTH-WEST SIDE OF HOUSE

PV DISCONNECT LOCATED:  
NORTH-WEST SIDE OF HOUSE

NEC 705.10  
PLACE AT SERVICE EQUIPMENT AND PV SYSTEM DISCONNECTING MEANS. FIELD VERIFY EQUIPMENT LOCATIONS AND LABEL ACCORDINGLY.

**LABEL NOTES**

1. LABELS SHOWN ARE HALF THEIR ACTUAL REQUIRED SIZE.
2. LABEL MATERIAL SHALL BE SUITABLE FOR THE EQUIPMENT ENVIRONMENT.
3. DC CONDUIT SHALL BE MARKED WITH REQUIRED LABEL EVERY 10 FEET.
4. LABELS WILL BE APPLIED IN ACCORDANCE WITH THE NEC. SOME LABELS MAY NOT BE NECESSARY.

**DC WIRING NOTES**

1. CONDUCTORS SHALL BE COPPER, RATED AT NOT LESS THAN 600 VOLTS FOR RESIDENTIAL CONSTRUCTION AND NOT LESS THAN 1000 VOLTS FOR COMMERCIAL CONSTRUCTION.
2. MINIMUM SIZE SHALL BE #10 AWG UNLESS OTHERWISE NOTED ON THE DRAWINGS.
3. EXPOSED WIRING CONDUCTOR INSULATION SHALL BE TYPE PV WIRE, USE-2, OR RHW-2 WHERE THE OUTER LAYER OF THE INSULATION IS UV, SUNLIGHT, AND MOISTURE RESISTANT.
4. EXTERIOR WIRING CONDUCTOR INSULATION SHALL BE TYPE THWN-2 AND INSTALLED IN ELECTRICAL METALLIC TUBING(EMT) OR RIGID POLYVINYL CHLORIDE CONDUIT(PVC). ALTERNATIVELY, METAL CLAD CABLE(MC) CAN BE USED AS WELL WHEN RATED FOR USE IN WET LOCATIONS.
5. INTERIOR WIRING CONDUCTOR INSULATION SHALL BE TYPE THHN-2 AND INSTALLED IN ELECTRICAL METALLIC TUBING(EMT), FLEXIBLE METAL CONDUIT(FMC), OR METAL CLAD CABLE(MC).
6. USE SCHEDULE 40 PVC OUTDOORS WHERE NOT SUBJECT TO PHYSICAL DAMAGE OR BELOW FLOOR SLAB. USE SCHEDULE 80 PVC OUTDOORS WHERE SUBJECT TO PHYSICAL DAMAGE.
7. MINIMUM CONDUIT SIZE TO BE 1/2".
8. WIRING METHODS TO CONFORM TO ARTICLES 330, 334, 348, 350, 352, 356, AND 358 OF THE 2017 NEC.

**AC WIRING NOTES**

1. CONDUCTORS SHALL BE COPPER RATED AT NOT LESS THAN 600 VOLTS.
2. MINIMUM SIZE SHALL BE #14 AWG UNLESS OTHERWISE NOTED ON THE DRAWINGS.
3. EXTERIOR WIRING CONDUCTOR INSULATION SHALL BE TYPE THWN AND INSTALLED IN ELECTRICAL METALLIC TUBING(EMT), RIGID POLYVINYL CHLORIDE CONDUIT(PVC), LIQUID-TIGHT FLEXIBLE METAL CONDUIT(LFMC), OR LIQUID-TIGHT FLEXIBLE NON-METALLIC CONDUIT(LFNC). ALTERNATIVELY, METAL CLAD CABLE(MC) CAN BE USED AS WELL WHEN RATED FOR USE IN WET LOCATIONS.
4. INTERIOR WIRING CONDUCTOR INSULATION SHALL BE TYPE THHN AND INSTALLED IN ELECTRICAL METALLIC TUBING(EMT), FLEXIBLE METAL CONDUIT(FMC), METAL CLAD CABLE(MC), OR ROMEX.
5. USE SCHEDULE 40 PVC OUTDOORS WHERE NOT SUBJECT TO PHYSICAL DAMAGE OR BELOW FLOOR SLAB. USE SCHEDULE 80 PVC OUTDOORS WHERE SUBJECT TO PHYSICAL DAMAGE.
6. MINIMUM CONDUIT SIZE TO BE 1/2".
7. WIRING METHODS TO CONFORM TO ARTICLES 330, 334, 348, 350, 352, 356, AND 358 OF THE 2017 NEC.

**CONSTRUCTION NOTES**

1. ALL WORK IS TO BE PERFORMED IN ACCORDANCE WITH THE NEC, STATE, AND LOCAL APPLICABLE CODES.
2. FOLLOW MANUFACTURER'S INSTALLATION INSTRUCTIONS, BEST PRACTICES, AND SPECIFICATIONS.
3. ENSURE REQUIRED MAINTENANCE ACCESS AND CLEARANCES ARE MAINTAINED.
4. WIRES SHALL BE RATED AND LABELED "SUNLIGHT RESISTANT" WHERE EXPOSED TO AMBIENT CONDITIONS.
5. FUSES 0 - 600 AMPS SHALL BE UL CLASS "RK-1" LOW PEAK DUAL ELEMENT TIME DELAY WITH 200,000 AMPERE INTERRUPTING RATING AS MANUFACTURED BY BUSSMANN, UNLESS NOTED OTHERWISE.
6. ALL TERMINALS/LUGS SHALL BE 75° RATED. ALL TERMINALS, SPLICING CONNECTORS, LUGS, ETC SHALL BE IDENTIFIED FOR USE WITH THE MATERIAL (CU/AL) OF THE CONDUCTOR AND SHALL BE PROPERLY INSTALLED.
7. PROVIDE A GROUNDING BARRIER IN ALL EMPTY CONDUITS.
8. ALL PENETRATIONS THROUGH EXTERIOR ROOFS SHALL BE FLASHED IN A WATERPROOF MANNER.
9. ALL PENETRATIONS THROUGH ATTIC FIRE BARRIERS SHALL BE SEALED WITH FIRE-BARRIER SEALANT CAULK.
10. SUPPORT ALL CONDUIT AND EQUIPMENT IN ACCORDANCE W/ NEC. ANY SUSPENDED MATERIALS SHALL BE DIRECTLY SUPPORTED BY THE BUILDING STRUCTURE.
11. METAL CONDUIT COUPLINGS CAN BE COMPRESSION TYPE, THREADED, OR BE SET-SCREW TYPE. PLASTIC CONDUIT COUPLINGS TO BE SOCKET GLUED TYPE.
12. A COMPLETE GROUNDING SYSTEM SHALL BE PRESENT OR PROVIDED AND INSTALLED IN ACCORDANCE WITH ARTICLE 250 OF THE NEC, AND AS SHOWN ON THE DRAWINGS.
13. EACH ELECTRICAL APPLIANCE SHALL BE PROVIDED WITH A NAMEPLATE GIVING THE IDENTIFYING NAME AND THE RATING IN VOLTS AND AMPERES, OR VOLTS AND WATTS. IF THE APPLIANCE IS TO BE USED ON A SPECIFIC FREQUENCY OR FREQUENCIES, IT SHALL BE SO MARKED WHERE MOTOR OVERLOAD PROTECTION EXTERNAL TO THE APPLIANCE IS REQUIRED, THE APPLIANCE SHALL BE SO MARKED.
14. WHERE APPLICABLE, GROUNDING ELECTRODE CONDUCTOR TO BE CONTINUOUS. GROUNDING CRIMPS TO BE IRREVERSIBLE.
15. PHOTOVOLTAIC SYSTEMS SHALL BE PERMANENTLY MARKED AT VARIOUS EQUIPMENT LOCATIONS TO IDENTIFY THAT A PHOTOVOLTAIC SYSTEM IS INSTALLED AND THAT VARIOUS DANGERS ARE PRESENT.
16. EACH PHOTOVOLTAIC SYSTEM DISCONNECTING MEANS SHALL BE PERMANENTLY MARKED TO IDENTIFY IT AS A PHOTOVOLTAIC SYSTEM DISCONNECT.
17. WHERE ALL TERMINALS OF A DISCONNECTING MEANS MAY BE ENERGIZED IN THE OPEN POSITION, A WARNING SIGN SHALL BE MOUNTED ON OR ADJACENT TO THE DISCONNECT.
18. A PERMANENT LABEL FOR THE DIRECT-CURRENT PHOTOVOLTAIC POWER SOURCE SHALL BE PROVIDED AT THE DC DISCONNECT MEANS.
19. A PERMANENT PLAQUE OR DIRECTORY, DENOTING ALL ELECTRIC POWER SOURCES SERVING THE PREMISES, SHALL BE INSTALLED AT EACH SERVICE EQUIPMENT LOCATION AND AT LOCATIONS OF ALL POWER PRODUCTION SOURCES.
20. ALL MODULE GROUND CONNECTIONS SHALL BE MADE IN ACCORDANCE WITH NEC SECTION 690.4 (C).
21. A NORTH CAROLINA REGISTERED DESIGN PROFESSIONAL WILL BE REQUIRED TO SEAL THE STRUCTURAL DESIGN AT THE TIME OF PERMIT APPLICATION IF ANY OF THE FOLLOWING EXIST AND ARE ATTESTED TO BY THE APPLICANT:
  - I. THE WEIGHT OF THE PV SYSTEM EXCEEDS THREE (3) POUNDS PER SQUARE FOOT(PSF)
  - II. THE ROOF POSSESSES MORE THAN ONE (1) LAYER OF ASPHALT SHINGLES
  - III. THE ROOFING MATERIAL CONSISTS OF A TYPE OTHER THAN ASPHALT SHINGLES OR METAL
  - IV. THE ROOF IS LOCATED IN A 140 MPH OR GREATER WIND ZONE

**NC SOLAR NOW**

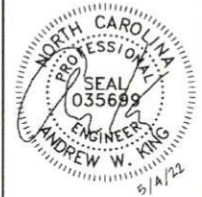

**CLIENT INFO**

DARIN R MOON - 64 PITCH PINE CT  
64 PITCH PINE COURT  
SANFORD, NC 27332

**PROJECT INFO**

DC INPUT: 15,200 kW  
AC EXPORT: 13,262 kW  
DOI INSP. METHOD: OPTION 2

**CODE REFERENCES**

NATION ELECTRICAL CODE v. 2017  
NC FIRE PROTECTION CODE v. 2018  
NC BUILDING CODE v. 2018  
NC RESIDENTIAL CODE v. 2018  
ACSE v. 7-10

**SITE CONDITIONS**

WIND SPEED: 116 MPH  
RISK CATEGORY: II  
EXPOSURE: B  
SNOW: 10 PSF

**SHEET INDEX**

PV-1 COVER SHEET  
PV-2 PV STRUCTURAL  
PV-3 PV ELECTRICAL  
PV-4 PV EQUIPMENT LABELS  
PV-5 PV INSTALL GUIDE

**DESIGNER INFO**

DESIGNER: MCP  
ENGINEER: AWK  
DATE: 5/2/2022  
VERSION: P1

**PV SYSTEM EQUIPMENT LABELS**

**PV-4.1**

© 2019 NC SOLAR NOW EXPRESSLY RESERVES ITS COMMON LAW COPYRIGHT AND OTHER PROPERTY RIGHTS IN THESE PLANS. THESE PLANS ARE NOT TO BE REPRODUCED, CHANGED OR COPIED IN ANY FORM OR MANNER WHATSOEVER, NOR ARE THEY TO BE ASSIGNED TO ANY THIRD PARTY WITHOUT FIRST OBTAINING THE EXPRESSED WRITTEN PERMISSION AND CONSENT OF NC SOLAR NOW.

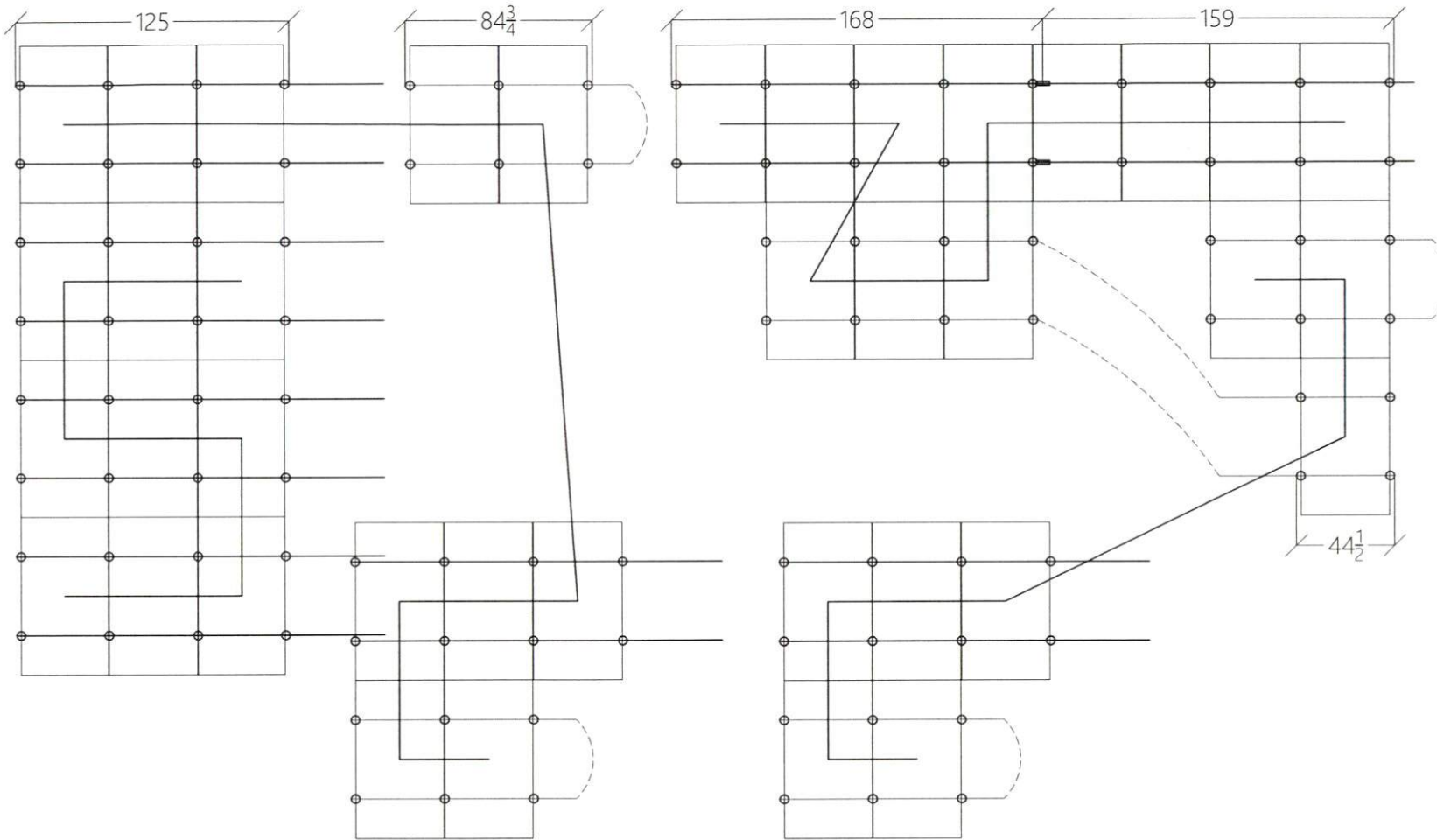

1 ARRAY LAYOUT DETAIL  
NOT TO SCALE

NC  
**SOLAR**  
NOW



**CLIENT INFO**

DARIN R MOON - 64 PITCH PINE CT  
64 PITCH PINE COURT  
SANFORD, NC 27332

**PROJECT INFO**

DC INPUT: 15,200 kW  
AC EXPORT: 13,262 kW  
DOI INSP. METHOD: OPTION 2

**CODE REFERENCES**

NATION ELECTRICAL CODE v. 2017  
NC FIRE PROTECTION CODE v. 2018  
NC BUILDING CODE v. 2018  
NC RESIDENTIAL CODE v. 2018  
ACSE v. 7-10

**SITE CONDITIONS**

WIND SPEED: 116 MPH  
RISK CATEGORY: II  
EXPOSURE: B  
SNOW: 10 PSF

**SHEET INDEX**

- PV-1 COVER SHEET
- PV-2 PV STRUCTURAL
- PV-3 PV ELECTRICAL
- PV-4 PV EQUIPMENT LABELS
- PV-5 PV INSTALL GUIDE

**DESIGNER INFO**

DESIGNER: MCP  
ENGINEER: AWK  
DATE: 5/2/2022  
VERSION: P1

**PV SYSTEM INSTALL  
GUIDE**

**PV-5.1**



Lillington  
North Carolina 27546

Take E Front St to S Main St

- ↑ 1. Head east toward S 1st St 2 min (0.2 mi)
- ↪ 2. Turn right onto S 1st St 384 ft
- ↪ 3. Turn right onto E Front St 220 ft
- ↪ 3. Turn right onto E Front St 443 ft

Take NC-27 W to Longleaf Pine Way

- ↶ 4. Turn left onto S Main St 23 min (19.2 mi)
- ↪ 5. Turn right onto W Old Rd 0.4 mi
- ↶ 6. Turn left onto NC-27 W 0.6 mi
- ↪ 7. Turn right onto Barbecue Church Rd 13.4 mi
- ↪ 7. Turn right onto Barbecue Church Rd 4.8 mi

Drive to Pitch Pine Ct

- ↶ 8. Turn left onto Longleaf Pine Way 43 s (0.1 mi)
- ↪ 9. Turn right onto Pitch Pine Ct 266 ft
- 📍 Destination will be on the right 315 ft

64 Pitch Pine Ct  
Sanford, NC 27332

These directions are for planning purposes only. You may find that construction projects, traffic, weather, or other events may cause conditions to differ from the map results, and you should plan your route accordingly. You must obey all signs or notices regarding your route.

SOLAR'S MOST TRUSTED

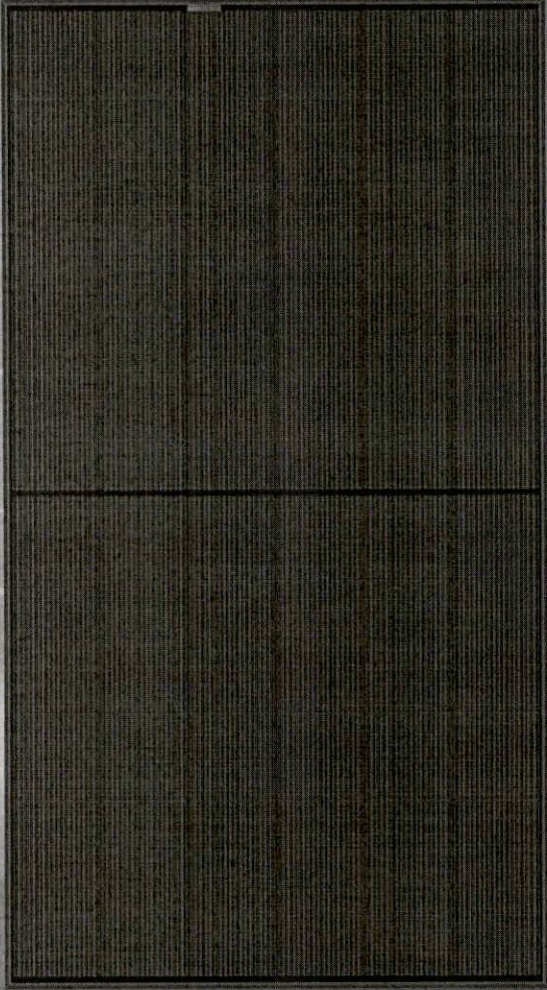

# REC ALPHA<sup>®</sup> PURE BLACK SERIES

PRODUCT SPECIFICATIONS

405WP  
20.3  $\frac{W}{FT^2}$



ELIGIBLE

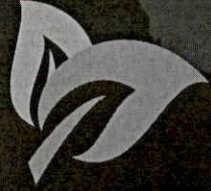

LEAD-FREE  
ROHS COMPLIANT

EXPERIENCE



PERFORMANCE

REC ALPHA PURE BLACK SERIES > PRODUCT SPECIFICATIONS

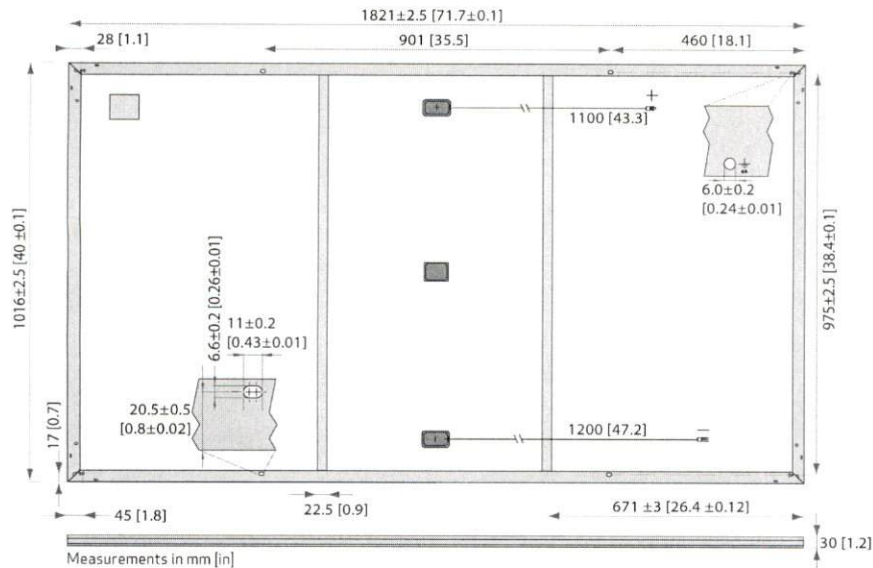

**GENERAL DATA**

Cell type:	132 half-cut REC heterojunction cells with lead-free, gapless technology 6 strings of 22 cells in series	Connectors:	Stäubli MC4PV-KBT4/12AWG(4mm <sup>2</sup> ) in accordance with IEC 62852 IP68 only when connected
Glass:	0.13 in (3.2 mm) solar glass with anti-reflection surface treatment	Cable:	12 AWG (4mm <sup>2</sup> ) PV wire, 43+47 in (11+1.2m) accordance with EN50618
Backsheet:	Highly resistant polymer (black)	Dimensions:	71.7 x 40 x 1.2 in (1821 x 1016 x 30 mm)
Frame:	Anodized aluminum (black)	Weight:	45 lbs (20.5 kg)
Junction box:	3-part, 3 bypass diodes, IP68 rated in accordance with IEC 62790	Origin:	Made in Singapore

**ELECTRICAL DATA**

**Product Code\*: RECxxxAA Pure Black**

	385	390	395	400	405
Power Output - P <sub>MAX</sub> (Wp)	385	390	395	400	405
Watt Class Sorting - (W)	0/+5	0/+5	0/+5	0/+5	0/+5
Nominal Power Voltage - V <sub>MPP</sub> (V)	41.2	41.5	41.8	42.1	42.4
Nominal Power Current - I <sub>MPP</sub> (A)	9.35	9.40	9.45	9.51	9.56
Open Circuit Voltage - V <sub>OC</sub> (V)	48.5	48.6	48.7	48.8	48.9
Short Circuit Current - I <sub>SC</sub> (A)	10.10	10.15	10.20	10.25	10.30
Power Density (W/sq ft)	19.3	19.6	19.8	20.1	20.3
Panel Efficiency (%)	20.8	21.1	21.3	21.6	21.9
Power Output - P <sub>MAX</sub> (Wp)	293	297	301	305	309
Nominal Power Voltage - V <sub>MPP</sub> (V)	38.8	39.1	39.4	39.7	40.0
Nominal Power Current - I <sub>MPP</sub> (A)	7.55	7.59	7.63	7.68	7.72
Open Circuit Voltage - V <sub>OC</sub> (V)	45.7	45.8	45.9	46.0	46.1
Short Circuit Current - I <sub>SC</sub> (A)	8.16	8.20	8.24	8.28	8.32

Values at standard test conditions (STC: air mass AM1.5, irradiance 10.75 W/sq ft (1000 W/m<sup>2</sup>), temperature 77°F (25°C), based on a production spread with a tolerance of P<sub>MAX</sub>, V<sub>OC</sub> & I<sub>SC</sub> ±3% within one watt class. Nominal module operating temperature (NMOT: air mass AM1.5, irradiance 800 W/m<sup>2</sup>, temperature 68°F (20°C), windspeed 3.3 ft/s (1 m/s). \* Where xxx indicates the nominal power class (P<sub>MAX</sub>) at STC above.

**CERTIFICATIONS**

IEC 61215:2016, IEC 61730:2016, UL 61730 (Pending)  
ISO 14001:2004, ISO 9001:2015, OHSAS 18001:2007, IEC 62941



**WARRANTY**

	Standard	REC ProTrust	
Installed by an REC Certified Solar Professional	No	Yes	Yes
System Size	All	<25 kW	25-500 kW
Product Warranty (yrs)	20	25	25
Power Warranty (yrs)	25	25	25
Labor Warranty (yrs)	0	25	10
Power in Year 1	98%	98%	98%
Annual Degradation	0.25%	0.25%	0.25%
Power in Year 25	92%	92%	92%

See warranty documents for details. Conditions apply

**MAXIMUM RATINGS**

Operational temperature:	-40 ... +185°F (-40 ... +85°C)
Maximum system voltage:	1000 V
Maximum test load (front):	+7000 Pa (146 lbs/sq ft)*
Maximum test load (rear):	-4000 Pa (83.5 lbs/sq ft)*
Max series fuse rating:	25 A
Max reverse current:	25 A

\* See installation manual for mounting instructions.  
Design load = Test load / 1.5 (safety factor)

**TEMPERATURE RATINGS\***

Nominal Module Operating Temperature:	44°C (±2°C)
Temperature coefficient of P <sub>MAX</sub> :	-0.26%/°C
Temperature coefficient of V <sub>OC</sub> :	-0.24%/°C
Temperature coefficient of I <sub>SC</sub> :	0.04%/°C

\*The temperature coefficients stated are linear values

**LOW LIGHT BEHAVIOUR**

Typical low irradiance performance of module at STC:

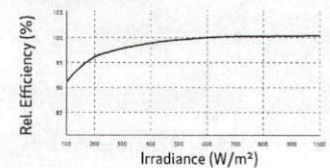

Founded in 1996, REC Group is an international pioneering solar energy company dedicated to empowering consumers with clean, affordable solar power. As Solar's Most Trusted, REC is committed to high quality, innovation, and a low carbon footprint in the solar materials and solar panels it manufactures. Headquartered in Norway with operational headquarters in Singapore, REC also has regional hubs in North America, Europe, and Asia-Pacific.



# Enphase IQ 7 and IQ 7+ Microinverters

The high-powered smart grid-ready Enphase IQ 7 Micro™ and Enphase IQ 7+ Micro™ dramatically simplify the installation process while achieving the highest system efficiency.

Part of the Enphase IQ System, the IQ 7 and IQ 7+ Microinverters integrate with the Enphase IQ Envoy™, Enphase IQ Battery™, and the Enphase Enlighten™ monitoring and analysis software.

IQ Series Microinverters extend the reliability standards set forth by previous generations and undergo over a million hours of power-on testing, enabling Enphase to provide an industry-leading warranty of up to 25 years.

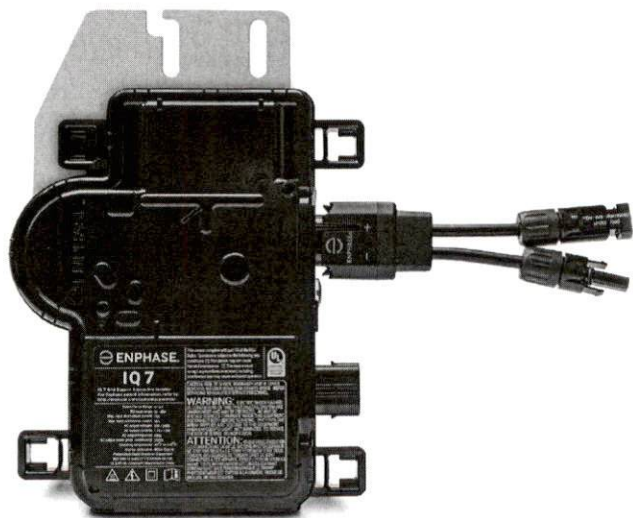

## Easy to Install

- Lightweight and simple
- Faster installation with improved, lighter two-wire cabling
- Built-in rapid shutdown compliant (NEC 2014 & 2017)

## Productive and Reliable

- Optimized for high powered 60-cell and 72-cell\* modules
- More than a million hours of testing
- Class II double-insulated enclosure
- UL listed

## Smart Grid Ready

- Complies with advanced grid support, voltage and frequency ride-through requirements
- Remotely updates to respond to changing grid requirements
- Configurable for varying grid profiles
- Meets CA Rule 21 (UL 1741-SA)

\* The IQ 7+ Micro is required to support 72-cell modules.



To learn more about Enphase offerings, visit [enphase.com](https://enphase.com)



## Enphase IQ 7 and IQ 7+ Microinverters

INPUT DATA (DC)	IQ7-60-2-US / IQ7-60-B-US		IQ7PLUS-72-2-US / IQ7PLUS-72-B-US	
Commonly used module pairings <sup>1</sup>	235 W - 350 W +		235 W - 440 W +	
Module compatibility	60-cell PV modules only		60-cell and 72-cell PV modules	
Maximum input DC voltage	48 V		60 V	
Peak power tracking voltage	27 V - 37 V		27 V - 45 V	
Operating range	16 V - 48 V		16 V - 60 V	
Min/Max start voltage	22 V / 48 V		22 V / 60 V	
Max DC short circuit current (module I <sub>sc</sub> )	15 A		15 A	
Overvoltage class DC port	II		II	
DC port backfeed current	0 A		0 A	
PV array configuration	1 x 1 ungrounded array; No additional DC side protection required; AC side protection requires max 20A per branch circuit			
OUTPUT DATA (AC)	IQ 7 Microinverter		IQ 7+ Microinverter	
Peak output power	250 VA		295 VA	
Maximum continuous output power	240 VA		290 VA	
Nominal (L-L) voltage/range <sup>2</sup>	240 V / 211-264 V	208 V / 183-229 V	240 V / 211-264 V	208 V / 183-229 V
Maximum continuous output current	1.0 A (240 V)	1.15 A (208 V)	1.21 A (240 V)	1.39 A (208 V)
Nominal frequency	60 Hz		60 Hz	
Extended frequency range	47 - 68 Hz		47 - 68 Hz	
AC short circuit fault current over 3 cycles	5.8 Arms		5.8 Arms	
Maximum units per 20 A (L-L) branch circuit <sup>3</sup>	16 (240 VAC)	13 (208 VAC)	13 (240 VAC)	11 (208 VAC)
Overvoltage class AC port	III		III	
AC port backfeed current	0 A		0 A	
Power factor setting	1.0		1.0	
Power factor (adjustable)	0.85 leading ... 0.85 lagging		0.85 leading ... 0.85 lagging	
EFFICIENCY	@240 V	@208 V	@240 V	@208 V
Peak efficiency	97.6 %	97.6 %	97.5 %	97.3 %
CEC weighted efficiency	97.0 %	97.0 %	97.0 %	97.0 %
MECHANICAL DATA				
Ambient temperature range	-40°C to +65°C			
Relative humidity range	4% to 100% (condensing)			
Connector type (IQ7-60-2-US & IQ7PLUS-72-2-US)	MC4 (or Amphenol H4 UTX with additional Q-DCC-5 adapter)			
Connector type (IQ7-60-B-US & IQ7PLUS-72-B-US)	Friends PV2 (MC4 intermateable). Adaptors for modules with MC4 or UTX connectors: - PV2 to MC4: order ECA-S20-S22 - PV2 to UTX: order ECA-S20-S25			
Dimensions (WxHxD)	212 mm x 175 mm x 30.2 mm (without bracket)			
Weight	1.08 kg (2.38 lbs)			
Cooling	Natural convection - No fans			
Approved for wet locations	Yes			
Pollution degree	PD3			
Enclosure	Class II double-insulated, corrosion resistant polymeric enclosure			
Environmental category / UV exposure rating	NEMA Type 6 / outdoor			
FEATURES				
Communication	Power Line Communication (PLC)			
Monitoring	Enlighten Manager and MyEnlighten monitoring options. Both options require installation of an Enphase IQ Envoy.			
Disconnecting means	The AC and DC connectors have been evaluated and approved by UL for use as the load-break disconnect required by NEC 690.			
Compliance	CA Rule 21 (UL 1741-SA) UL 62109-1, UL1741/IEEE1547, FCC Part 15 Class B, ICES-0003 Class B, CAN/CSA-C22.2 NO. 107.1-01 This product is UL Listed as PV Rapid Shut Down Equipment and conforms with NEC-2014 and NEC-2017 section 690.12 and C22.1-2015 Rule 64-218 Rapid Shutdown of PV Systems, for AC and DC conductors, when installed according manufacturer's instructions.			

1. No enforced DC/AC ratio. See the compatibility calculator at <https://enphase.com/en-us/support/module-compatibility>

2. Nominal voltage range can be extended beyond nominal if required by the utility.

3. Limits may vary. Refer to local requirements to define the number of microinverters per branch in your area.

To learn more about Enphase offerings, visit [enphase.com](https://enphase.com)

