

© 2019 NC SOLAR NOW EXPRESSLY RESERVES ITS COMMON LAW COPYRIGHT AND OTHER PROPERTY RIGHTS IN THESE PLANS. THESE PLANS ARE NOT TO BE REPRODUCED, CHANGED OR COPIED IN ANY FORM OR MANNER WHATSOEVER, NOR ARE THEY TO BE ASSIGNED TO ANY THIRD PARTY WITHOUT FIRST OBTAINING THE EXPRESSED WRITTEN PERMISSION AND CONSENT OF NC SOLAR NOW.

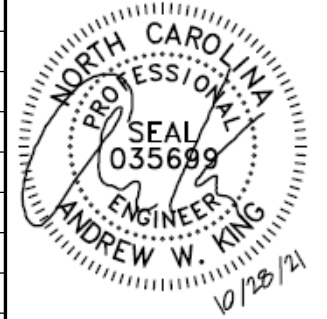

PV MATERIAL SUMMARY: DISTRIBUTOR

Q.PEAK DUO BLK ML-G10+400	20
P401	20
SE7600H-US000BNI4	1
SE-WFGW-B-S1-NA	1
SECT-SPL-400A-T-20	2
XR-10-168B	2
XR-10-204B	9
XR10-BOSS-01-M1	6
UFO-CL-01-B1	46
UFO-STP-32MM-B1	12
XR-LUG-03-A1	3
QB DECK MOUNT 16317	70
GC66803 Geocel Sealant	5
SOLADECK 0799-5B	1



CLIENT INFO

BOBBIE MCNEILL WICKER
2929 HOLLY SPRINGS CHURCH RD
BROADWAY, NC 27505

PROJECT INFO

DC INPUT: 8.000 kW
AC EXPORT: 7.600 kW
DOI INSP. METHOD: OPTION 2

CODE REFERENCES

NATION ELECTRICAL CODE v. 2017
NC FIRE PROTECTION CODE v. 2018
NC BUILDING CODE v. 2018
NC RESIDENTIAL CODE v. 2018
ACSE v. 7-10

SITE CONDITIONS

WIND SPEED: 116 MPH
RISK CATEGORY: II
EXPOSURE: B
SNOW: 15 PSF

SHEET INDEX

PV-1: COVER SHEET
PV-2: PV STRUCTURAL
PV-3: PV ELECTRICAL
PV-4: PV EQUIPMENT LABELS
PV-5: PV INSTALL GUIDE



DESIGNER INFO

DESIGNER: CRM
ENGINEER: AWK
DATE: 10/26/2021
VERSION: P1

PV SYSTEM COVER PAGE

PV-1.1

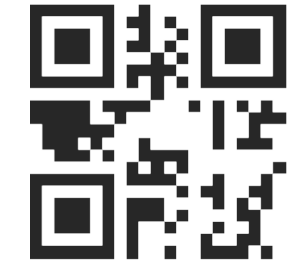

© 2019 NC SOLAR NOW EXPRESSLY RESERVES ITS COMMON LAW COPYRIGHT AND OTHER PROPERTY RIGHTS IN THESE PLANS. THESE PLANS ARE NOT TO BE REPRODUCED, CHANGED OR COPIED IN ANY FORM OR MANNER WHATSOEVER, NOR ARE THEY TO BE ASSIGNED TO ANY THIRD PARTY WITHOUT FIRST OBTAINING THE EXPRESSED WRITTEN PERMISSION AND CONSENT OF NC SOLAR NOW.

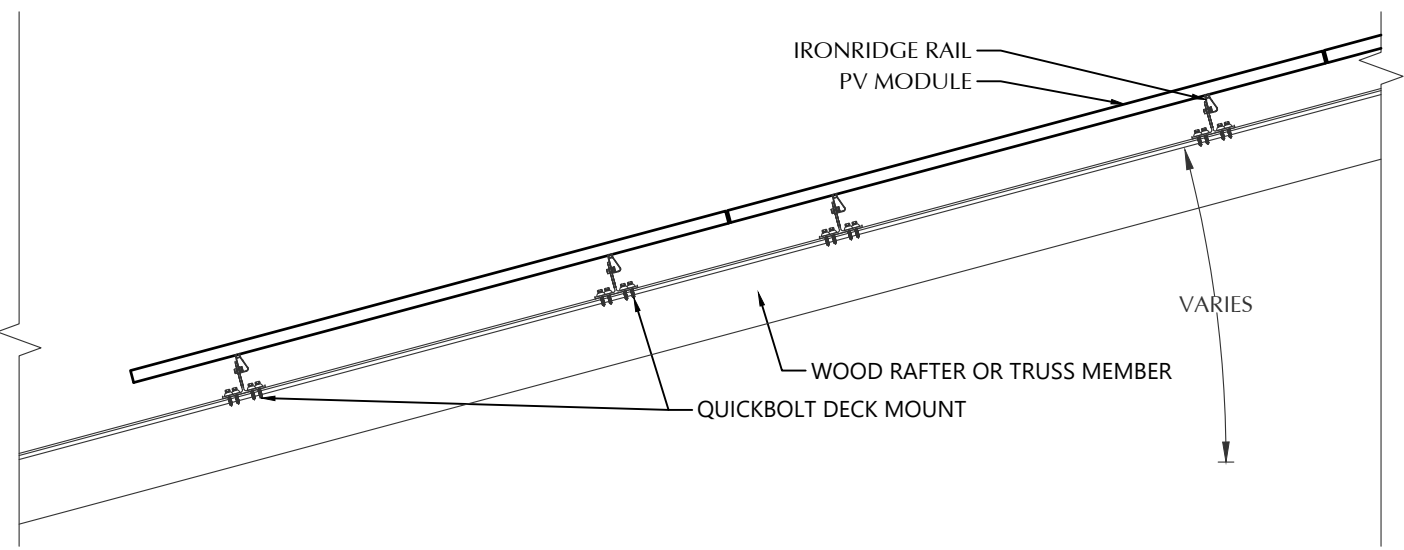

STATEMENT OF STRUCTURAL COMPLIANCE

THE EXISTING ROOF STRUCTURE HAS BEEN DESIGNED TO SUPPORT THE ADDITIONAL LOADS OF THE PROPOSED PV SYSTEM. IN ADDITION, THE RACKING AND FASTENING SYSTEM SHALL BE CAPABLE OF SECURING THE SYSTEM TO THE STRUCTURE UNDER DESIGN CONDITIONS WHEN INSTALLED PROPERLY AND IN ACCORDANCE WITH THE RACKING AND FASTENING ARRANGEMENT DETAILED WITHIN THESE DRAWINGS.

NAME: ANDREW W. KING, PE
 SIGNED: *Andrew W. King*

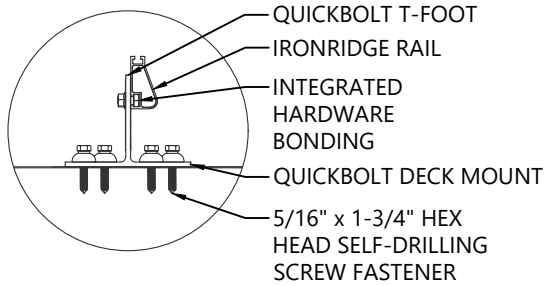
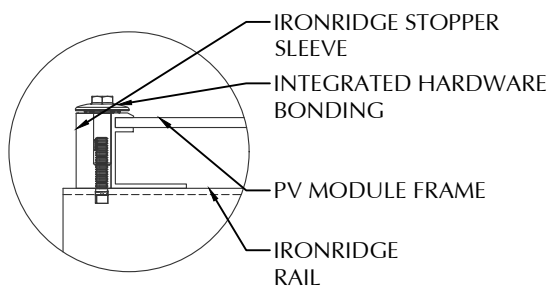
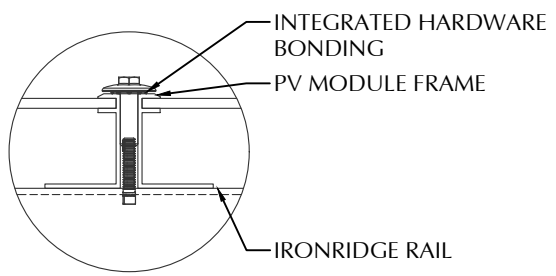
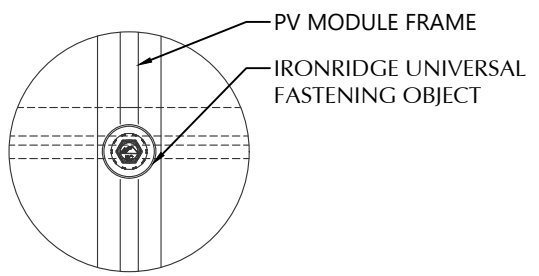
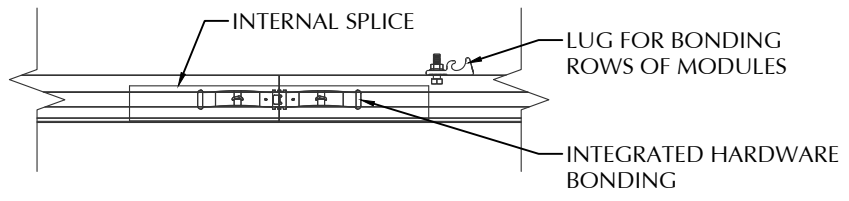

1 ROOF FASTENER DETAIL
NOT TO SCALE

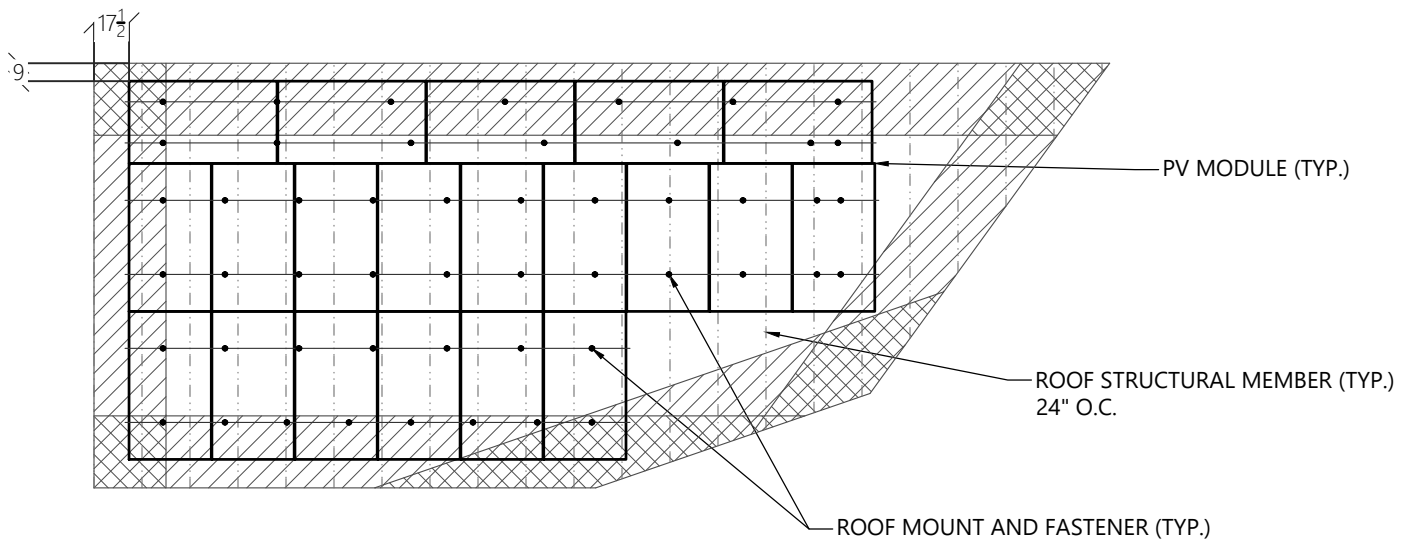

2 ROOF A ARRAY LAYOUT
1/8" = 1'-0"

PV MODULES	
MAKE	HANWHA
MODEL	Q.PEAK DUO BLK ML-G10+400
WIDTH	41.10 IN
LENGTH	74.00 IN
THICKNESS	32 MM
WEIGHT	48.50 LBS.
ARRAY AREA	422 SQFT.
ARRAY WEIGHT	1056 LBS.

ROOF SUMMARY	
STRUCTURE:	
TYPE	TRUSSES
MATERIAL	SOUTHERN PINE #2
SIZE	2 X 4
SPACING	24 IN O.C.
ALLOWABLE SPAN	88 IN
PITCH	10/12
DENSITY	30 LBS./CU.FT.
DECKING:	
TYPE	OSB
MATERIAL	COMPOSITE
THICKNESS	7/16 IN
WEIGHT	1.60 LBS./SQFT
ROOFING:	
TYPE	ASPHALT SHINGLE
MATERIAL	ASPHALT
WEIGHT	2.30 LBS./SQFT.

ROOF MOUNT SUMMARY		
MAXIMUM (IN)	MOUNT SPACING	RAIL OVERHANG
WIND ZONE 1	PORT 37 LAND 67	19 IN
WIND ZONE 2	PORT 31 LAND 57	19 IN
WIND ZONE 3	PORT 31 LAND 57	19 IN

ROOF LOADING	
GROUND SNOW LOAD:	15 LBS./SQFT.
LIVE LOAD	20 LBS./SQFT.
DEAD LOAD	
ROOFING	3.9 LBS./SQFT.
PV ARRAY	2.5 LBS./SQFT.
TOTAL	6.4 LBS./SQFT.
WIND LOAD:	
UPLIFT ZONE 1	-24.6 LBS./SQFT.
UPLIFT ZONE 2	-29.0 LBS./SQFT.
UPLIFT ZONE 3	-29.0 LBS./SQFT.
DOWNWARD	23.0 LBS./SQFT.
FASTENER LOAD:	
UPLIFT ZONE 1	-230 LBS.
UPLIFT ZONE 2	-210 LBS.
UPLIFT ZONE 3	-191 LBS.
DOWNWARD	215 LBS.

ROOF MOUNT & FASTENER	
ROOF MOUNT:	
MAKE	QUICKBOLT
MODEL	QB DECK MOUNT 16317
MATERIAL	STAINLESS / EPDM
FASTENER:	
MAKE	QUICK SCREWS
MODEL	HEX LAG PN# 16318
MATERIAL	304 SS
SIZE	5/16" X 1-3/4"
GENERAL:	
WEIGHT	0.88 LBS.
FASTENERS PER MOUNT	4
MAX. PULL-OUT FORCE	705.0 LBS.
SAFETY FACTOR	3
DESIGN PULL-OUT FORCE	235.0 LBS.

MOUNTING RAILS	
MAKE	IRONRIDGE
MODEL	XR10
MATERIAL	ALUMINUM
WEIGHT	0.425 LBS/IN
SPACING	37 IN

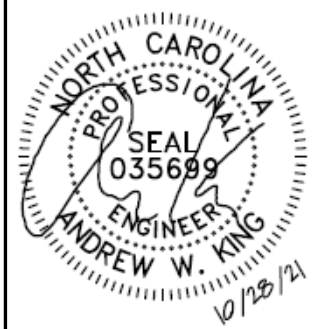

CLIENT INFO

BOBBIE MCNEILL WICKER
 2929 HOLLY SPRINGS CHURCH RD
 BROADWAY, NC 27505

PROJECT INFO

DC INPUT: 8.000 kW
 AC EXPORT: 7.600 kW
 DOI INSPT. METHOD: OPTION 2

CODE REFERENCES

NATION ELECTRICAL CODE v. 2017
 NC FIRE PROTECTION CODE v. 2018
 NC BUILDING CODE v. 2018
 NC RESIDENTIAL CODE v. 2018
 ACSE v. 7-10

SITE CONDITIONS

WIND SPEED: 116 MPH
 RISK CATEGORY: II
 EXPOSURE: B
 SNOW: 15 PSF

SHEET INDEX

PV-1: COVER SHEET
 PV-2: PV STRUCTURAL
 PV-3: PV ELECTRICAL
 PV-4: PV EQUIPMENT LABELS
 PV-5: PV INSTALL GUIDE

DESIGNER INFO

DESIGNER: CRM
 ENGINEER: AWK
 DATE: 10/26/2021
 VERSION: P1

PV SYSTEM STRUCTURAL

PV-2.1

© 2019 NC SOLAR NOW EXPRESSLY RESERVES ITS COMMON LAW COPYRIGHT AND OTHER PROPERTY RIGHTS IN THESE PLANS. THESE PLANS ARE NOT TO BE REPRODUCED, CHANGED OR COPIED IN ANY FORM OR MANNER WHATSOEVER, NOR ARE THEY TO BE ASSIGNED TO ANY THIRD PARTY WITHOUT FIRST OBTAINING THE EXPRESSED WRITTEN PERMISSION AND CONSENT OF NC SOLAR NOW.

CONDUCTOR SCHEDULE

TAG	CURRENT CARRYING CONDUCTORS			GROUNDING CONDUCTORS			CONDUIT/RACEWAY			NOTES
	QTY.	SIZE	INSULATION	QTY.	SIZE	INSULATION	QTY.	SIZE	LOCATION	
C1	4	10 AWG	PV WIRE	1	6 AWG	BARE	-	-	FREE AIR	1
C2	4	10 AWG	THWN	1	10 AWG	THWN	1	3/4"	EXT/INT	2,4
C3	3	8 AWG	THWN	1	10 AWG	THWN	1	3/4"	EXTERIOR	2,4
C4	3	6 AWG	THWN	-	-	-	1	3/4"	EXTERIOR	2,4
XC	-	-	-	-	-	-	-	-	-	3

NOTES:

1. MANUFACTURER PROVIDED, UL LISTED WIRING HARNESS FOR USE ON EXPOSED ROOFS
2. CONDUIT SIZE SHOWN IS CODE MINIMUM. LARGER SIZES ARE ALLOWED.
3. EXISTING CONDUCTORS, FIELD VERIFY
4. EQUIPMENT TERMINAL RATING SHALL BE A MINIMUM OF 75°C AT BOTH END OF CONDUCTOR

PV MODULE	
MAKE	HANWHA
MODEL	Q.PEAK DUO BLK ML-G10+400
NOM. POWER (PNOM)	400 WATTS
NOM. VOLT. (VMPP)	37.1 VOLTS
O.C. VOLT (VOC)	45.3 VOLTS
MAX. SYS. VOLT.	1000 VOLTS
NOM. CURR. (IMPP)	10.8 AMPS
S.C. CURR. (ISC)	11.1 AMPS
TEMP. COEF. (PMPP)	-0.34 %/C
TEMP. COEF. (Voc)	-0.27 %/C
MAX SERIES FUSE	20 AMPS
UL LIST. (Y/N)	YES

MODULE OPTIMIZER	
MAKE	SOLAREEDGE
MODEL	P401
DC INPUT:	
NOM. POWER	400 WATTS
VOLT. RANGE	8 to 60
MAX. CURR.	11.8 AMPS
DC OUTPUT:	
NOM. POWER	400 WATTS
MAX. VOLT.	60 VOLTS
MAX. CURR.	15 AMPS
MIN-MAX STRING	8-25 OPTIMIZERS
UL LIST. (Y/N)	YES

DC / AC INVERTER	
MAKE	SOLAREEDGE
MODEL	SE7600H-US000BNI4
DC INPUT:	
MAX POWER	11800 WATTS
VOLT. RANGE	400-480
NOM. VOLT.	400 VOLTS
MAX. CURRENT	20 AMPS
STRING INPUTS	2 STRINGS
AC OUTPUT:	
MAX. POWER	7600 WATTS
NOM. POWER	7600 WATTS
NOM. VOLT.	211-240-264
MAX. CURR.	32.00 AMPS
DC DISC. (Y/N)	YES
RAPID SHUTDOWN (Y/N)	YES
PROTECT. RATING	NEMA TYPE 4X
UL LIST. (Y/N)	YES
CONSUMPTION MONITOR	YES

JUNCTION BOX	
MAKE	SOLADECK
PROTECT. RATING	NEMA TYPE 3R
UL LIST. (Y/N)	YES

MD PANEL (EXISTING)	
MAKE	SIEMENS
MODEL	NA
ENCL. RATING	NEMA 3R
VOLT. RATING	240
BUS RATING	200 AMPS
UL LIST. (Y/N)	YES
MAIN BREAKER (Y/N)	YES
MAIN BREAKER RATING	200 AMPS

AC DISCONNECT	
MAKE	GENERIC
MODEL	NA
ENCL. RATING	NEMA 3R
VOLT. RATING	240 VOLTS
AMP RATING	60 AMPS
UL LIST. (Y/N)	YES
FUSED (Y/N)	YES
FUSE RATING	40 A

- BACK-FEED SOLAR OUTPUT VIA SUPPLY SIDE TAP INSIDE OF MD PANEL
- LOAD-BREAK RATED
- VISIBLE OPEN
- LOCKABLE IN OPEN POSITION
- INSTALL ADJACENT TO METER
- DISCONNECT TO BE READILY ACCESSIBLE TO UTILITY COMPANY PERSONNEL AT ALL TIMES
- SERVICE RATED
- PROVIDE NEUTRAL/GROUND BONDING JUMPER

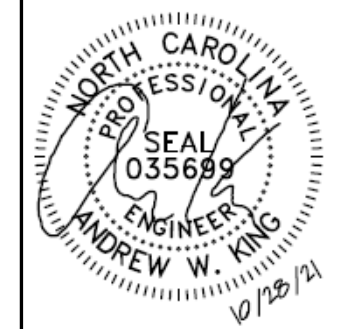

CLIENT INFO
 BOBBIE MCNEILL WICKER
 2929 HOLLY SPRINGS CHURCH RD
 BROADWAY, NC 27505

PROJECT INFO
 DC INPUT: 8.000 kW
 AC EXPORT: 7.600 kW
 DOI INSP. METHOD: OPTION 2

CODE REFERENCES
 NATION ELECTRICAL CODE v. 2017
 NC FIRE PROTECTION CODE v. 2018
 NC BUILDING CODE v. 2018
 NC RESIDENTIAL CODE v. 2018
 ACSE v. 7-10

SITE CONDITIONS
 WIND SPEED: 116 MPH
 RISK CATEGORY: II
 EXPOSURE: B
 SNOW: 15 PSF

SHEET INDEX
 PV-1: COVER SHEET
 PV-2: PV STRUCTURAL
 PV-3: PV ELECTRICAL
 PV-4: PV EQUIPMENT LABELS
 PV-5: PV INSTALL GUIDE

DESIGNER INFO
 DESIGNER: CRM
 ENGINEER: AWK
 DATE: 10/26/2021
 VERSION: P1

PV SYSTEM ELECTRICAL

PV-3.1

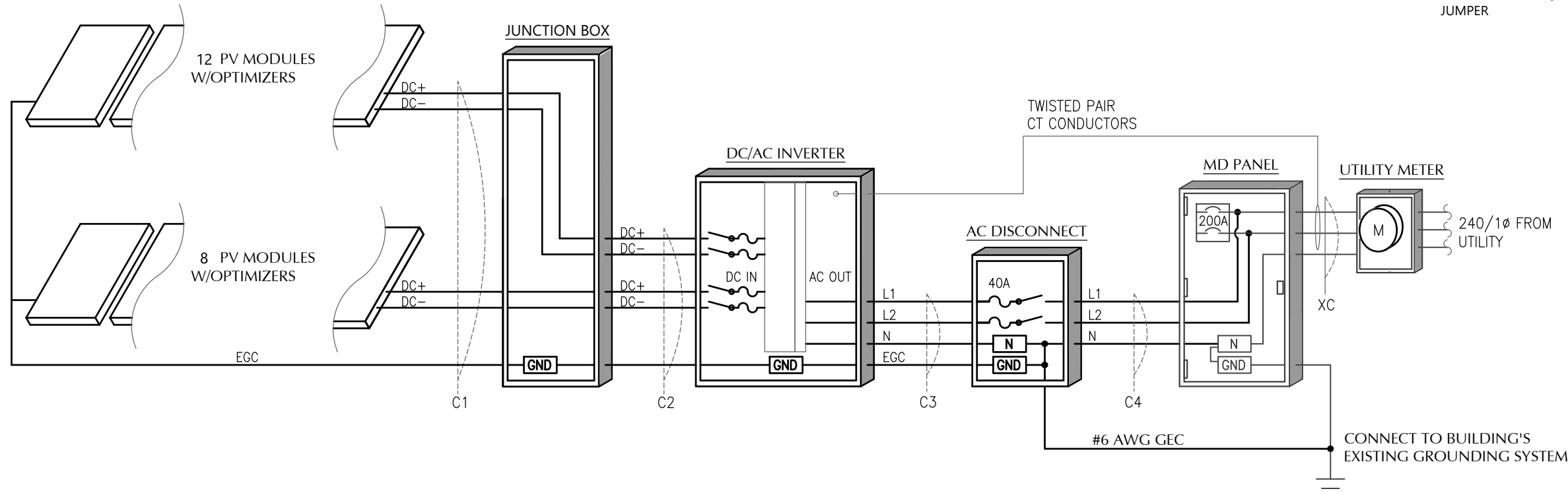

1 ELECTRICAL SCHEMATIC
 NTS

© 2019 NC SOLAR NOW EXPRESSLY RESERVES ITS COMMON LAW COPYRIGHT AND OTHER PROPERTY RIGHTS IN THESE PLANS. THESE PLANS ARE NOT TO BE REPRODUCED, CHANGED OR COPIED IN ANY FORM OR MANNER WHATSOEVER, NOR ARE THEY TO BE ASSIGNED TO ANY THIRD PARTY WITHOUT FIRST OBTAINING THE EXPRESSED WRITTEN PERMISSION AND CONSENT OF NC SOLAR NOW.

⚠ WARNING
ELECTRIC SHOCK HAZARD
 TERMINALS ON THE LINE AND LOAD SIDES MAY BE ENERGIZED IN THE OPEN POSITION

NEC 690.13 (B)
 PLACE ON PV SYSTEM DISCONNECTING MEANS.

⚠ WARNING
POWER SOURCE OUTPUT CONNECTION DO NOT RELOCATE THIS OVERCURRENT DEVICE

NEC 705.12 (B)(2)(3)(b)
 PLACE ADJACENT TO BACK-FED BREAKER

⚠ WARNING
DUAL POWER SUPPLY
 SOURCES: UTILITY GRID AND PV SOLAR ELECTRIC SYSTEM

NEC 705.12 (B)(3)
 PLACE ON ALL EQUIPMENT THAT IS SUPPLIED BY BOTH POWER SOURCES

WARNING: PHOTOVOLTAIC POWER SOURCE

NEC 690.31 (G)(3)&(4)
 PLACE ON ALL JUNCTION BOXES, EXPOSED RACEWAYS, AND OTHER WIRING METHODS EVERY 10' AND ON EVERY SECTION SEPARATED BY ENCLOSURES, WALLS, PARTITIONS, CEILINGS, OR FLOORS.

RAPID SHUTDOWN SWITCH FOR SOLAR PV SYSTEM

NEC 690.56 (C)(3)
 PLACE ON RAPID SHUTDOWN SWITCH OR EQUIPMENT WITH INTEGRATED RAPID SHUTDOWN *REFLECTIVE*

SOLAR PV SYSTEM EQUIPPED WITH RAPID SHUTDOWN

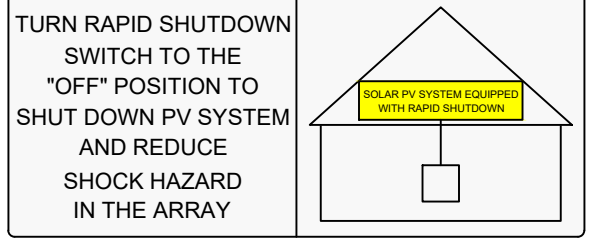

NEC 690.56 (C)(1)(a)
 PLACE WITHIN 3FT OF SERVICE DISCONNECTING MEANS TO WHICH THE PV SYSTEMS ARE CONNECTED AND SHALL INDICATE THE LOCATIONS OF RAPID SHUTDOWN SWITCHES

PV SYSTEM DISCONNECT

NEC 690.13 (B)
 PLACE ON PV SYSTEM DISCONNECTING MEANS.

PHOTOVOLTAIC POWER SOURCE
 OPERATING AC VOLTAGE 240 V
 MAXIMUM OPERATING AC OUTPUT CURRENT 32.0 A

NEC 690.54
 PLACE ON INTERCONNECTION DISCONNECTING MEANS

DIRECT CURRENT PHOTOVOLTAIC POWER SOURCE
 MAXIMUM VOLTAGE 600 VDC
 MAX CIRCUIT CURRENT 30.0 AMPS

NEC 690.53
 PLACE ON ALL DC DISCONNECTING MEANS

SERVICE DISCONNECT LOCATED: EXTERIOR NW WALL OF RESIDENCE
PV DISCONNECT LOCATED: EXTERIOR NW WALL OF RESIDENCE

NEC 705.10
 PLACE AT SERVICE EQUIPMENT AND PV SYSTEM DISCONNECTING MEANS. FIELD VERIFY EQUIPMENT LOCATIONS AND LABEL ACCORDINGLY.

LABEL NOTES

1. LABELS SHOWN ARE HALF THEIR ACTUAL REQUIRED SIZE.
2. LABEL MATERIAL SHALL BE SUITABLE FOR THE EQUIPMENT ENVIRONMENT.
3. DC CONDUIT SHALL BE MARKED WITH REQUIRED LABEL EVERY 10 FEET.
4. LABELS WILL BE APPLIED IN ACCORDANCE WITH THE NEC. SOME LABELS MAY NOT BE NECESSARY.

DC WIRING NOTES

1. CONDUCTORS SHALL BE COPPER, RATED AT NOT LESS THAN 600 VOLTS FOR RESIDENTIAL CONSTRUCTION AND NOT LESS THAN 1000 VOLTS FOR COMMERCIAL CONSTRUCTION.
2. MINIMUM SIZE SHALL BE #10 AWG UNLESS OTHERWISE NOTED ON THE DRAWINGS.
3. EXPOSED WIRING CONDUCTOR INSULATION SHALL BE TYPE PV WIRE, USE-2, OR RHW-2 WHERE THE OUTER LAYER OF THE INSULATION IS UV, SUNLIGHT, AND MOISTURE RESISTANT.
6. EXTERIOR WIRING CONDUCTOR INSULATION SHALL BE TYPE THWN-2 AND INSTALLED IN ELECTRICAL METALLIC TUBING(EMT) OR RIGID POLYVINYL CHLORIDE CONDUIT(PVC). ALTERNATIVELY, METAL CLAD CABLE(MC) CAN BE USED AS WELL WHEN RATED FOR USE IN WET LOCATIONS.
7. INTERIOR WIRING CONDUCTOR INSULATION SHALL BE TYPE THHN-2 AND INSTALLED IN ELECTRICAL METALLIC TUBING(EMT), FLEXIBLE METAL CONDUIT(FMC), OR METAL CLAD CABLE(MC).
6. USE SCHEDULE 40 PVC OUTDOORS WHERE NOT SUBJECT TO PHYSICAL DAMAGE OR BELOW FLOOR SLAB. USE SCHEDULE 80 PVC OUTDOORS WHERE SUBJECT TO PHYSICAL DAMMAGE
7. MINIMUM CONDUIT SIZE TO BE 1/2".
8. WIRING METHODS TO CONFORM TO ARTICLES 330, 334, 348, 350, 352, 356, AND 358 OF THE 2017 NEC.

AC WIRING NOTES

1. CONDUCTORS SHALL BE COPPER RATED AT NOT LESS THAN 600 VOLTS.
2. MINIMUM SIZE SHALL BE #14 AWG UNLESS OTHERWISE NOTED ON THE DRAWINGS.
3. EXTERIOR WIRING CONDUCTOR INSULATION SHALL BE TYPE THWN AND INSTALLED IN ELECTRICAL METALLIC TUBING(EMT), RIGID POLYVINYL CHLORIDE CONDUIT(PVC), LIQUID-TIGHT FLEXIBLE METAL CONDUIT(LFMC), OR LIQUID-TIGHT FLEXIBLE NON-METALLIC CONDUIT(LFNC) . ALTERNATIVELY, METAL CLAD CABLE(MC) CAN BE USED AS WELL WHEN RATED FOR USE IN WET LOCATIONS.
4. INTERIOR WIRING CONDUCTOR INSULATION SHALL BE TYPE THHN AND INSTALLED IN ELECTRICAL METALLIC TUBING(EMT), FLEXIBLE METAL CONDUIT(FMC), METAL CLAD CABLE(MC), OR ROMEX.
5. USE SCHEDULE 40 PVC OUTDOORS WHERE NOT SUBJECT TO PHYSICAL DAMAGE OR BELOW FLOOR SLAB. USE SCHEDULE 80 PVC OUTDOORS WHERE SUBJECT TO PHYSICAL DAMMAGE
6. MINIMUM CONDUIT SIZE TO BE 1/2".
7. WIRING METHODS TO CONFORM TO ARTICLES 330, 334, 348, 350, 352, 356, AND 358 OF THE 2017 NEC.

CONSTRUCTION NOTES

1. ALL WORK IS TO BE PERFORMED IN ACCORDANCE WITH THE NEC, STATE, AND LOCAL APPLICABLE CODES.
2. FOLLOW MANUFACTURER'S INSTALLATION INSTRUCTIONS, BEST PRACTICES, AND SPECIFICATIONS.
3. ENSURE REQUIRED MAINTENANCE ACCESS AND CLEARANCES ARE MAINTAINED.
4. WIRES SHALL BE RATED AND LABELED "SUNLIGHT RESISTANT" WHERE EXPOSED TO AMBIENT CONDITIONS.
5. FUSES 0 - 600 AMPS SHALL BE UL CLASS "RK-1" LOW PEAK DUAL ELEMENT TIME DELAY WITH 200,000 AMPERE INTERRUPTING RATING AS MANUFACTURED BY BUSSMANN, UNLESS NOTED OTHERWISE.
6. ALL TERMINALS/LUGS SHALL BE 75° RATED. ALL TERMINALS, SPlicing CONNECTORS, LUGS, ETC SHALL BE IDENTIFIED FOR USE WITH THE MATERIAL (CU/AL) OF THE CONDUCTOR AND SHALL BE PROPERLY INSTALLED.
7. PROVIDE A PULLWIRE IN ALL EMPTY CONDUITS.
8. ALL PENETRATIONS THROUGH EXTERIOR ROOFS SHALL BE FLASHED IN A WATERPROOF MANNER.
9. ALL PENETRATIONS THROUGH ATTIC FIRE BARRIERS SHALL BE SEALED WITH FIRE-BARRIER SEALANT CAULK.
10. SUPPORT ALL CONDUIT AND EQUIPMENT IN ACCORDANCE W/ NEC. ANY SUSPENDED MATERIALS SHALL BE DIRECTLY SUPPORTED BY THE BUILDING STRUCTURE.
11. METAL CONDUIT COUPLINGS CAN BE COMPRESSION TYPE, THREADED, OR BE SET-SCREW TYPE. PLASTIC CONDUIT COUPLINGS TO BE SOCKET GLUED TYPE.
12. A COMPLETE GROUNDING SYSTEM SHALL BE PRESENT OR PROVIDED AND INSTALLED IN ACCORDANCE WITH ARTICLE 250 OF THE NEC, AND AS SHOWN ON THE DRAWINGS.
13. EACH ELECTRICAL APPLIANCE SHALL BE PROVIDED WITH A NAMEPLATE GIVING THE IDENTIFYING NAME AND THE RATING IN VOLTS AND AMPERES, OR VOLTS AND WATTS. IF THE APPLIANCE IS TO BE USED ON A SPECIFIC FREQUENCY OR FREQUENCIES, IT SHALL BE SO MARKED. WHERE MOTOR OVERLOAD PROTECTION EXTERNAL TO THE APPLIANCES IS REQUIRED, THE APPLIANCE SHALL BE SO MARKED.
14. WHERE APPLICABLE, GROUNDING ELECTRODE CONDUCTOR TO BE CONTINUOUS. GROUNDING CRIMPS TO BE IRREVERSIBLE.
15. PHOTOVOLTAIC SYSTEMS SHALL BE PERMANENTLY MARKED AT VARIOUS EQUIPMENT LOCATIONS TO IDENTIFY THAT A PHOTOVOLTAIC SYSTEM IS INSTALLED AND THAT VARIOUS DANGERS ARE PRESENT.
16. EACH PHOTOVOLTAIC SYSTEM DISCONNECTING MEANS SHALL BE PERMANENTLY MARKED TO IDENTIFY IT AS A PHOTOVOLTAIC SYSTEM DISCONNECT.
17. WHERE ALL TERMINALS OF A DISCONNECTING MEANS MAY BE ENERGIZED IN THE OPEN POSITION, A WARNING SIGN SHALL BE MOUNTED ON OR ADJACENT TO THE DISCONNECT.
18. A PERMANENT LABEL FOR THE DIRECT-CURRENT PHOTOVOLTAIC POWER SOURCE SHALL BE PROVIDED AT THE DC DISCONNECT MEANS.
19. A PERMANENT PLAQUE OR DIRECTORY, DENOTING ALL ELECTRIC POWER SOURCES SERVING THE PREMISES, SHALL BE INSTALLED AT EACH SERVICE EQUIPMENT LOCATION AND AT LOCATIONS OF ALL POWER PRODUCTION SOURCES.
20. ALL MODULE GROUND CONNECTIONS SHALL BE MADE IN ACCORDANCE WITH NEC SECTION 690.4 (C).
21. A NORTH CAROLINA REGISTERED DESIGN PROFESSIONAL WILL BE REQUIRED TO SEAL THE STRUCTURAL DESIGN AT THE TIME OF PERMIT APPLICATION IF ANY OF THE FOLLOWING EXIST AND ARE ATTESTED TO BY THE APPLICANT:
 - I. THE WEIGHT OF THE PV SYSTEM EXCEEDS THREE (3) POUNDS PER SQUARE FOOT(PSF)
 - II. THE ROOF POSSESSES MORE THAN ONE (1) LAYER OF ASPHALT SHINGLES
 - III. THE ROOFING MATERIAL CONSISTS OF A TYPE OTHER THAN ASPHALT SHINGLES OR METAL
 - IV. THE ROOF IS LOCATED IN A 140 MPH OR GREATER WIND ZONE

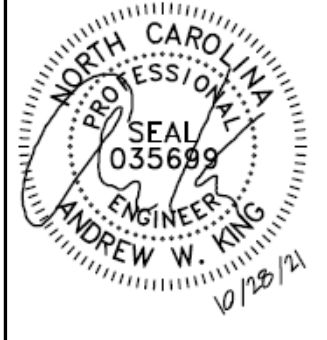

CLIENT INFO

BOBBIE MCNEILL WICKER
 2929 HOLLY SPRINGS CHURCH RD
 BROADWAY, NC 27505

PROJECT INFO

DC INPUT: 8.000 kW
 AC EXPORT: 7.600 kW
 DOI INSP. METHOD: OPTION 2

CODE REFERENCES

NATION ELECTRICAL CODE v. 2017
 NC FIRE PROTECTION CODE v. 2018
 NC BUILDING CODE v. 2018
 NC RESIDENTIAL CODE v. 2018
 ACSE v. 7-10

SITE CONDITIONS

WIND SPEED: 116 MPH
 RISK CATEGORY: II
 EXPOSURE: B
 SNOW: 15 PSF

SHEET INDEX

PV-1: COVER SHEET
 PV-2: PV STRUCTURAL
 PV-3: PV ELECTRICAL
 PV-4: PV EQUIPMENT LABELS
 PV-5: PV INSTALL GUIDE

DESIGNER INFO

DESIGNER: CRM
 ENGINEER: AWK
 DATE: 10/26/2021
 VERSION: P1

PV SYSTEM EQUIPMENT LABELS

PV-4.1

© 2019 NC SOLAR NOW EXPRESSLY RESERVES ITS COMMON LAW COPYRIGHT AND OTHER PROPERTY RIGHTS IN THESE PLANS. THESE PLANS ARE NOT TO BE REPRODUCED, CHANGED OR COPIED IN ANY FORM OR MANNER WHATSOEVER, NOR ARE THEY TO BE ASSIGNED TO ANY THIRD PARTY WITHOUT FIRST OBTAINING THE EXPRESSED WRITTEN PERMISSION AND CONSENT OF NC SOLAR NOW.

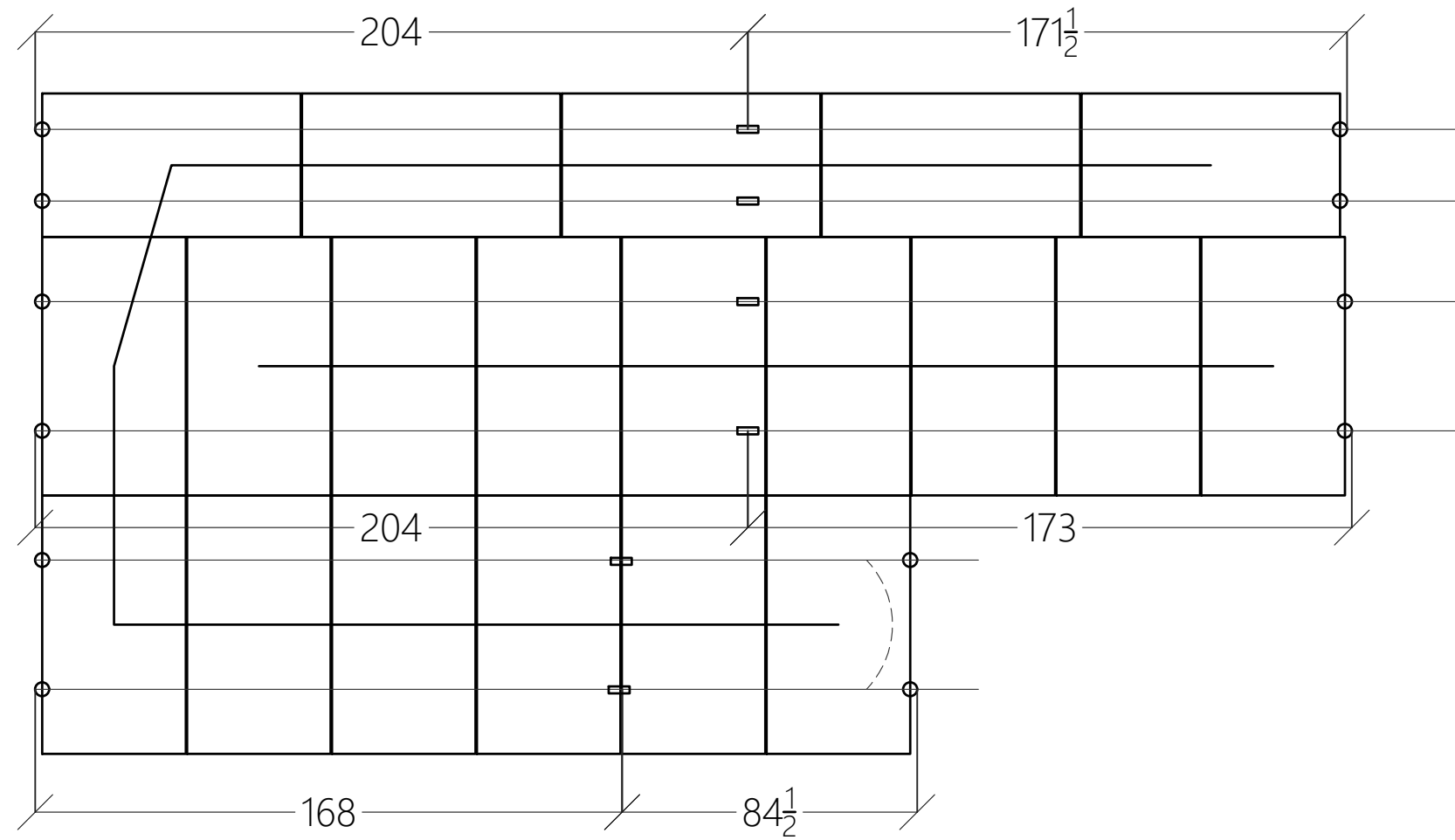

1 ARRAY LAYOUT DETAIL
NOT TO SCALE

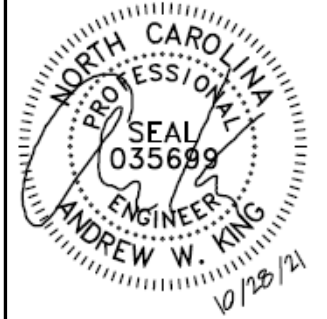

CLIENT INFO

BOBBIE MCNEILL WICKER
2929 HOLLY SPRINGS CHURCH RD
BROADWAY, NC 27505

PROJECT INFO

DC INPUT: 8.000 kW
AC EXPORT: 7.600 kW
DOI INSPT. METHOD: OPTION 2

CODE REFERENCES

NATION ELECTRICAL CODE v. 2017
NC FIRE PROTECTION CODE v. 2018
NC BUILDING CODE v. 2018
NC RESIDENTIAL CODE v. 2018
ACSE v. 7-10

SITE CONDITIONS

WIND SPEED: 116 MPH
RISK CATEGORY: II
EXPOSURE: B
SNOW: 15 PSF

SHEET INDEX

PV-1: COVER SHEET
PV-2: PV STRUCTURAL
PV-3: PV ELECTRICAL
PV-4: PV EQUIPMENT LABELS
PV-5: PV INSTALL GUIDE

DESIGNER INFO

DESIGNER: CRM
ENGINEER: AWK
DATE: 10/26/2021
VERSION: P1

PV SYSTEM INSTALL GUIDE

PV-5.1

Q.PEAK DUO BLK ML-G10

385-405

ENDURING HIGH PERFORMANCE



BREAKING THE 20% EFFICIENCY BARRIER

Q.ANTUM DUO Z Technology with zero gap cell layout boosts module efficiency up to 20.9%.



INNOVATIVE ALL-WEATHER TECHNOLOGY

Optimal yields, whatever the weather with excellent low-light and temperature behaviour.



ENDURING HIGH PERFORMANCE

Long-term yield security with Anti LID Technology, Anti PID Technology¹, Hot-Spot Protect and Traceable Quality Tra.Q™.



EXTREME WEATHER RATING

High-tech aluminium alloy frame, certified for high snow (5400 Pa) and wind loads (4000 Pa).



A RELIABLE INVESTMENT

Inclusive 12-year product warranty and 25-year linear performance warranty².



STATE OF THE ART MODULE TECHNOLOGY

Q.ANTUM DUO combines cutting edge cell separation and innovative wiring with Q.ANTUM Technology.

¹ APT test conditions according to IEC/TS 62804-1:2015, method B (-1500V, 168h)

² See data sheet on rear for further information.

THE IDEAL SOLUTION FOR:



Rooftop arrays on residential buildings

MECHANICAL SPECIFICATION

Format	1879 mm × 1045 mm × 32 mm (including frame)
Weight	22.0 kg
Front Cover	3.2 mm thermally pre-stressed glass with anti-reflection technology
Back Cover	Composite film
Frame	Black anodised aluminium
Cell	6 × 22 monocrystalline Q.ANTUM solar half cells
Junction box	53-101 mm × 32-60 mm × 15-18 mm Protection class IP67, with bypass diodes
Cable	4 mm ² Solar cable; (+) ≥ 1200 mm, (-) ≥ 1200 mm
Connector	Stäubli MC4, Hanwha Q CELLS HQC4; IP68

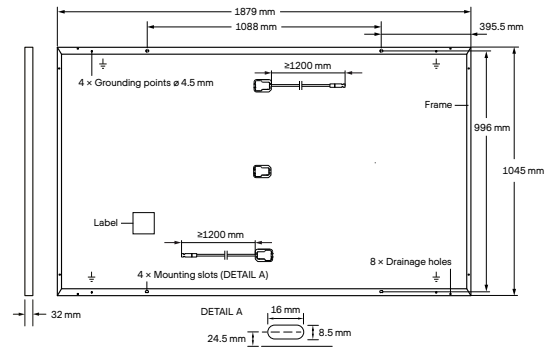

ELECTRICAL CHARACTERISTICS

POWER CLASS			385	390	395	400	405
MINIMUM PERFORMANCE AT STANDARD TEST CONDITIONS, STC ¹ (POWER TOLERANCE +5 W / -0 W)							
Minimum	Power at MPP ¹	P_{MPP} [W]	385	390	395	400	405
	Short Circuit Current ¹	I_{SC} [A]	11.04	11.07	11.10	11.14	11.17
	Open Circuit Voltage ¹	V_{OC} [V]	45.19	45.23	45.27	45.30	45.34
	Current at MPP	I_{MPP} [A]	10.59	10.65	10.71	10.77	10.83
	Voltage at MPP	V_{MPP} [V]	36.36	36.62	36.88	37.13	37.39
	Efficiency ¹	η [%]	≥ 19.6	≥ 19.9	≥ 20.1	≥ 20.4	≥ 20.6
MINIMUM PERFORMANCE AT NORMAL OPERATING CONDITIONS, NMOT ²							
Minimum	Power at MPP	P_{MPP} [W]	288.8	292.6	296.3	300.1	303.8
	Short Circuit Current	I_{SC} [A]	8.90	8.92	8.95	8.97	9.00
	Open Circuit Voltage	V_{OC} [V]	42.62	42.65	42.69	42.72	42.76
	Current at MPP	I_{MPP} [A]	8.35	8.41	8.46	8.51	8.57
	Voltage at MPP	V_{MPP} [V]	34.59	34.81	35.03	35.25	35.46

¹Measurement tolerances $P_{MPP} \pm 3\%$; I_{SC} ; $V_{OC} \pm 5\%$ at STC: 1000 W/m², 25 ± 2°C, AM 1.5 according to IEC 60904-3 • ²800 W/m², NMOT, spectrum AM 1.5

Q CELLS PERFORMANCE WARRANTY

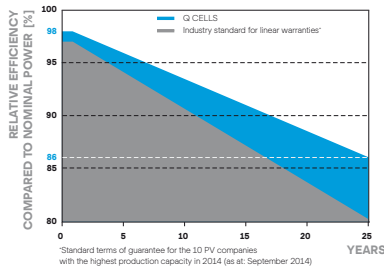

At least 98% of nominal power during first year. Thereafter max. 0.5% degradation per year. At least 93.5% of nominal power up to 10 years. At least 86% of nominal power up to 25 years.

All data within measurement tolerances. Full warranties in accordance with the warranty terms of the Q CELLS sales organisation of your respective country.

¹Standard terms of guarantee for the 10 PV companies with the highest production capacity in 2014 (as at September 2014)

PERFORMANCE AT LOW IRRADIANCE

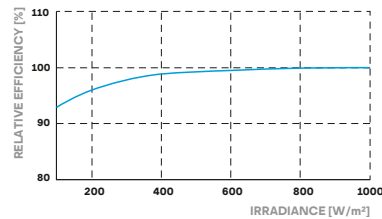

Typical module performance under low irradiance conditions in comparison to STC conditions (25°C, 1000 W/m²).

TEMPERATURE COEFFICIENTS

Temperature Coefficient of I_{SC}	α [%/K]	+0.04	Temperature Coefficient of V_{OC}	β [%/K]	-0.27
Temperature Coefficient of P_{MPP}	γ [%/K]	-0.34	Nominal Module Operating Temperature	NMOT [°C]	43 ± 3

PROPERTIES FOR SYSTEM DESIGN

Maximum System Voltage	V_{SYS} [V]	1000	PV module classification	Class II
Maximum Reverse Current	I_R [A]	20	Fire Rating based on ANSI / UL 61730	C / TYPE 2
Max. Design Load, Push / Pull	[Pa]	3600 / 2660	Permitted Module Temperature on Continuous Duty	-40°C - +85°C
Max. Test Load, Push / Pull	[Pa]	5400 / 4000		

QUALIFICATIONS AND CERTIFICATES

IEC 61215:2016;
IEC 61730:2016.
This data sheet complies
with DIN EN 50380.



www.tuv.com
ID 1111220277

Note: Installation instructions must be followed. See the installation and operating manual or contact our technical service department for further information on approved installation and use of this product.

Hanwha Q CELLS GmbH

Sonnenallee 17-21, 06766 Bitterfeld-Wolfen, Germany | TEL +49 (0)3494 66 99-23444 | FAX +49 (0)3494 66 99-23000 | EMAIL sales@q-cells.com | WEB www.q-cells.com

Single Phase Inverter with HD-Wave Technology

for North America

SE3000H-US / SE3800H-US / SE5000H-US / SE6000H-US /
SE7600H-US / SE10000H-US / SE11400H-US



Optimized installation with HD-Wave technology

- Specifically designed to work with power optimizers
- Record-breaking efficiency
- Quick and easy inverter commissioning directly from a smartphone using the SolarEdge SetApp
- Fixed voltage inverter for longer strings
- Integrated arc fault protection and rapid shutdown for NEC 2014 and 2017, per article 690.11 and 690.12
- UL1741 SA certified, for CPUC Rule 21 grid compliance
- Extremely small
- Built-in module-level monitoring
- Outdoor and indoor installation
- Optional: Revenue grade data, ANSI C12.20 Class 0.5 (0.5% accuracy)

/ Single Phase Inverter with HD-Wave Technology for North America

SE3000H-US / SE3800H-US / SE5000H-US / SE6000H-US/
SE7600H-US / SE10000H-US / SE11400H-US

Model Number	SE3000H-US	SE3800H-US	SE5000H-US	SE6000H-US	SE7600H-US	SE10000H-US	SE11400H-US	
APPLICABLE TO INVERTERS WITH PART NUMBER	SEXXXXH-XXXXXBXX4							
OUTPUT								
Rated AC Power Output	3000	3800 @ 240V 3300 @ 208V	5000	6000 @ 240V 5000 @ 208V	7600	10000	11400 @ 240V 10000 @ 208V	VA
Maximum AC Power Output	3000	3800 @ 240V 3300 @ 208V	5000	6000 @ 240V 5000 @ 208V	7600	10000	11400 @ 240V 10000 @ 208V	VA
AC Output Voltage Min.-Nom.-Max. (211 - 240 - 264)	✓	✓	✓	✓	✓	✓	✓	Vac
AC Output Voltage Min.-Nom.-Max. (183 - 208 - 229)	-	✓	-	✓	-	-	✓	Vac
AC Frequency (Nominal)	59.3 - 60 - 60.5 ⁽¹⁾							Hz
Maximum Continuous Output Current @240V	12.5	16	21	25	32	42	47.5	A
Maximum Continuous Output Current @208V	-	16	-	24	-	-	48.5	A
Power Factor	1, adjustable -0.85 to 0.85							
GFDI Threshold	1							A
Utility Monitoring, Islanding Protection, Country Configurable Thresholds	Yes							
INPUT								
Maximum DC Power @240V	4650	5900	7750	9300	11800	15500	17650	W
Maximum DC Power @208V	-	5100	-	7750	-	-	15500	W
Transformer-less, Ungrounded	Yes							
Maximum Input Voltage	480							Vdc
Nominal DC Input Voltage	380				400			Vdc
Maximum Input Current @240V ⁽²⁾	8.5	10.5	13.5	16.5	20	27	30.5	Adc
Maximum Input Current @208V ⁽²⁾	-	9	-	13.5	-	-	27	Adc
Max. Input Short Circuit Current	45							Adc
Reverse-Polarity Protection	Yes							
Ground-Fault Isolation Detection	600k Ω Sensitivity							
Maximum Inverter Efficiency	99	99.2						%
CEC Weighted Efficiency	99						99 @ 240V 98.5 @ 208V	%
Nighttime Power Consumption	< 2.5							W

⁽¹⁾ For other regional settings please contact SolarEdge support

⁽²⁾ A higher current source may be used; the inverter will limit its input current to the values stated

/ Single Phase Inverter with HD-Wave Technology for North America

SE3000H-US / SE3800H-US / SE5000H-US / SE6000H-US/
SE7600H-US / SE10000H-US / SE11400H-US

Model Number	SE3000H-US	SE3800H-US	SE5000H-US	SE6000H-US	SE7600H-US	SE10000H-US	SE11400H-US
ADDITIONAL FEATURES							
Supported Communication Interfaces	RS485, Ethernet, ZigBee (optional), Cellular (optional)						
Revenue Grade Data, ANSI C12.20	Optional ⁽³⁾						
Inverter Commissioning	with the SetApp mobile application using built-in Wi-Fi Access Point for local connection						
Rapid Shutdown - NEC 2014 and 2017 690.12	Automatic Rapid Shutdown upon AC Grid Disconnect						
STANDARD COMPLIANCE							
Safety	UL1741, UL1741 SA, UL1699B, CSA C22.2, Canadian AFCI according to T.I.L. M-07						
Grid Connection Standards	IEEE1547, Rule 21, Rule 14 (HI)						
Emissions	FCC Part 15 Class B						
INSTALLATION SPECIFICATIONS							
AC Output Conduit Size / AWG Range	1" Maximum / 14-6 AWG			1" Maximum /14-4 AWG			
DC Input Conduit Size / # of Strings / AWG Range	1" Maximum / 1-2 strings / 14-6 AWG			1" Maximum / 1-3 strings / 14-6 AWG			
Dimensions with Safety Switch (HxWxD)	17.7 x 14.6 x 6.8 / 450 x 370 x 174			21.3 x 14.6 x 7.3 / 540 x 370 x 185			in / mm
Weight with Safety Switch	22 / 10	25.1 / 11.4	26.2 / 11.9	38.8 / 17.6			lb / kg
Noise	< 25			<50			dBA
Cooling	Natural Convection						
Operating Temperature Range	-40 to +140 / -40 to +60 ⁽⁴⁾						
Protection Rating	NEMA 4X (Inverter with Safety Switch)						

⁽³⁾ Revenue grade inverter P/N: SExxxxH-US000BNC4

⁽⁴⁾ Full power up to at least 50°C / 122°F; for power de-rating information refer to: <https://www.solaredge.com/sites/default/files/se-temperature-derating-note-na.pdf>

Power Optimizer

Frame-Mounted

P370 / P401 / P404 / P500



POWER OPTIMIZER

Fast mount power optimizers with module-level optimization

- Specifically designed to work with SolarEdge inverters
- Quicker installation - Power optimizers can be mounted in advance saving installation time
- Up to 25% more energy
- Superior efficiency (99.5%)
- Mitigates all types of modules mismatch-loss, from manufacturing tolerance to partial shading
- Flexible system design for maximum space utilization
- Next generation maintenance with module level monitoring
- Module-level voltage shutdown for installer and firefighter safety

/ Power Optimizer

Frame-Mounted

P370 / P401 / P404 / P500

OPTIMIZER MODEL (TYPICAL MODULE COMPATIBILITY)	P370 (FOR HIGH-POWER 60-CELL AND FOR 72-CELL MODULES)	P401 (FOR HIGH POWER 60/72-CELL MODULES)	P404 (FOR 60-CELL AND 72-CELL, SHORT STRINGS)	P500 (FOR 96-CELL MODULES)	
INPUT					
Rated Input DC Power ⁽¹⁾	370	400	405	500	W
Absolute Maximum Input Voltage (Voc at lowest temperature)	60		80		Vdc
MPPT Operating Range	8 - 60		12.5 - 80	8 - 80	Vdc
Maximum Short Circuit Current (Isc)	11	11.75	11	10.1	Adc
Maximum Efficiency	99.5				%
Weighted Efficiency	98.8				%
Overvoltage Category	II				
OUTPUT DURING OPERATION (POWER OPTIMIZER CONNECTED TO OPERATING SOLAREEDGE INVERTER)					
Maximum Output Current	15				Adc
Maximum Output Voltage	60		85	60	Vdc
OUTPUT DURING STANDBY (POWER OPTIMIZER DISCONNECTED FROM SOLAREEDGE INVERTER OR SOLAREEDGE INVERTER OFF)					
Safety Output Voltage per Power Optimizer	1 ± 0.1				Vdc
STANDARD COMPLIANCE					
EMC	FCC Part15 Class B, IEC61000-6-2, IEC61000-6-3				
Safety	IEC62109-1 (class II safety), UL1741				
RoHS	Yes				
Fire Safety	VDE-AR-E 2100-712:2013-05				
INSTALLATION SPECIFICATIONS					
Maximum Allowed System Voltage	1000				Vdc
Dimensions (W x L x H)	139 x 165 x 40 / 5.5 x 6.5 x 1.6	129 x 153 x 29.5 / 5.08 x 6.02 x 1.16	139 x 165 x 48 / 5.5 x 6.5 x 1.9		mm / in
Weight (including cables)	775 / 1.7	655 / 1.5	895 / 2.0	870 / 1.9	gr / lb
Input Connector	MC4 ⁽²⁾				
Input Wire Length	0.16 / 0.52				m / ft
Output Connector	MC4				
Output Wire Length	1.2 / 3.9				m / ft
Operating Temperature Range ⁽³⁾	-40 to +85 / -40 to +185				°C / °F
Protection Rating	IP68 / NEMA6P				
Relative Humidity	0 - 100				%

(1) Rated power of the module at STC will not exceed the optimizer "Rated Input DC Power". Modules with up to +5% Power tolerance are allowed

(2) For other connector types please contact SolarEdge

(3) For ambient temperature above +85°C / +185°F power de-rating is applied. Refer to Power Optimizers Temperature De-Rating Technical Note for more details

PV SYSTEM DESIGN USING A SOLAREEDGE INVERTER ⁽⁴⁾		SINGLE PHASE HD-WAVE	SINGLE PHASE	THREE PHASE	THREE PHASE FOR 277/480V GRID	
Minimum String Length (Power Optimizers)	P370/ P401/ P500 ⁽⁵⁾	8		16	18	
	P404	6		14 (13 with SE3K) ⁽⁶⁾	14	
Maximum String Length (Power Optimizers)		25		50	50	
Maximum Nominal Power per String		5700 ⁽⁷⁾	5250 ⁽⁷⁾	11250 ⁽⁸⁾	12750	W
Parallel Strings of Different Lengths or Orientations		Yes				

(4) It is not allowed to mix P404 with P370/P401/P500 in one string

(5) The P370/P401/P500 cannot be used with the SE3K three phase inverter (available in some countries; refer to Three Phase Inverter SE3K-SE10K datasheet)

(6) Exactly 10 when using SE3K-RW010BNN4

(7) If the inverters rated AC power ≤ maximum nominal power per string, then the maximum power per string will be able to reach up to the inverters maximum input DC power Refer to: <https://www.solaredge.com/sites/default/files/se-power-optimizer-single-string-design-application-note.pdf>

(8) For SE27.6K, SE55K, SE82.8K: It is allowed to install up to 13,500W per string when 3 strings are connected to the inverter and when the maximum power difference between the strings is up to 2,000W; inverter max DC power: 37,250W

