













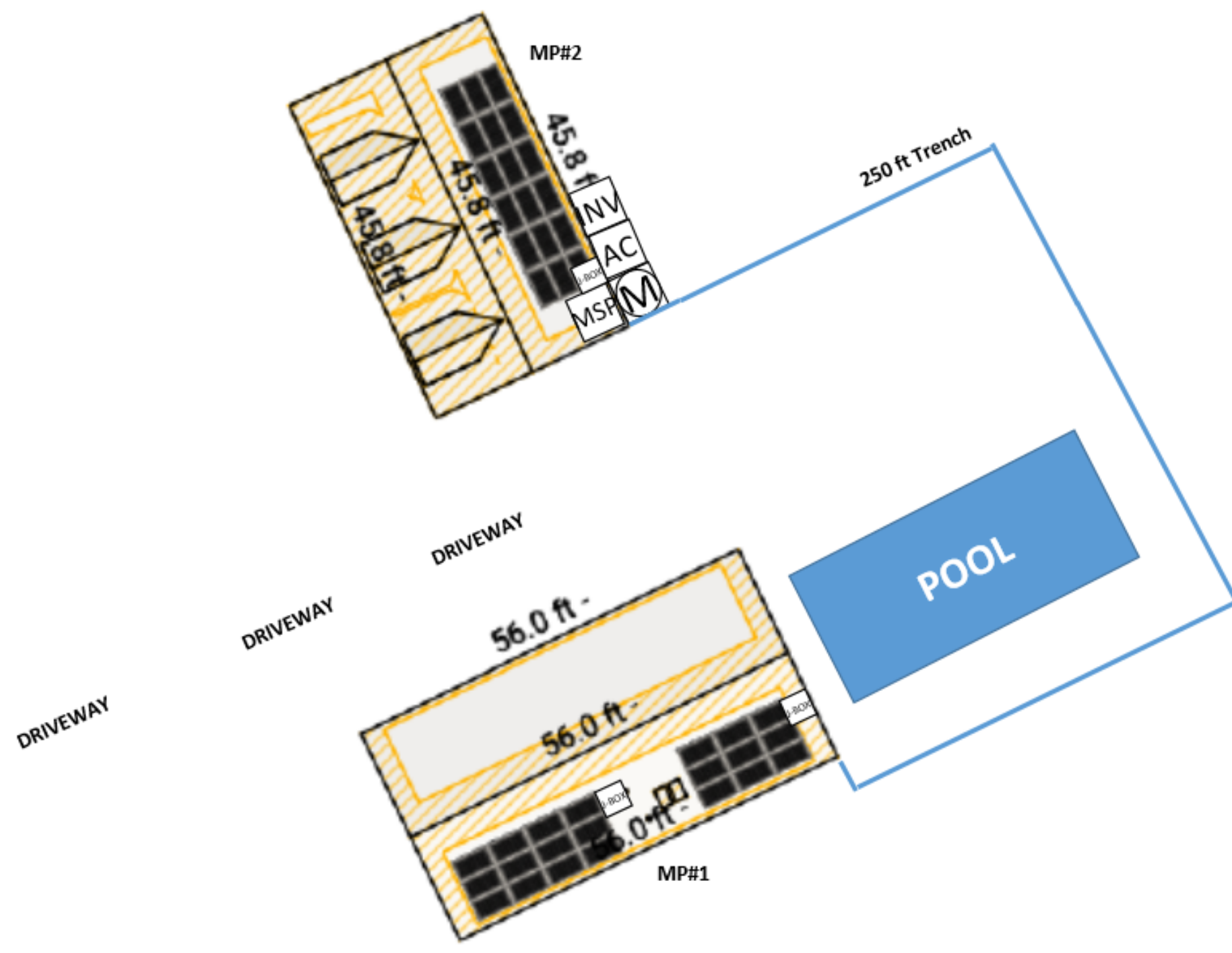

GENERAL NOTES	AERIAL VIEW	SHEET INDEX
<p>1. INSTALLATION OF SOLAR PHOTOVOLTAIC SYSTEM SHALL BE IN ACCORDANCE WITH NEC ARTICLE 690, AND ALL OTHER APPLICABLE NEC CODES WHERE NOTED OR EXISTING.</p> <p>2. PROPER ACCESS AND WORKING CLEARANCE AROUND EXISTING AND PROPOSED ELECTRICAL EQUIPMENT WILL COMPLY WITH NEC ARTICLE 110.</p> <p>3. ALL WIRES, INCLUDING THE GROUNDING ELECTRODE CONDUCTOR SHALL BE PROTECTED FROM PHYSICAL DAMAGE IN ACCORDANCE WITH NEC ARTICLE 250</p> <p>4. THE PV MODULES ARE CONSIDERED NON-COMBUSTIBLE; THIS SYSTEM IS UTILITY INTERACTIVE PER UL 1741 AND DOES NOT INCLUDE STORAGE BATTERIES OR OTHER ALTERNATIVE STORAGE SOURCES.</p> <p>5. ALL DC WIRES SHALL BE SIZED ACCORDING TO [NEC 690.8]</p> <p>6. DC CONDUCTORS SHALL BE WITHIN PROTECTED RACEWAYS IN ACCORDANCE WITH [NEC 690.31]</p> <p>7. ALL SIGNAGE TO BE PLACED IN ACCORDANCE WITH LOCAL JURISDICTIONAL BUILDING CODE.</p>		<p>PV1 Cover Page PV2 Site Plan PV3 Mounting Detail PV4 Electrical Diagram PV5 Labels PV6 Placard</p> <div data-bbox="2666 747 2924 842" style="border: 1px solid red; padding: 2px; margin: 10px auto; width: fit-content;"> <p style="font-size: 8px; margin: 0;">NOTICE TO CONTRACTOR <small>THIS APPROVAL DOES NOT CONSTITUTE A WARRANTY OR GUARANTEE OF ANY KIND.</small></p> <p style="font-size: 8px; margin: 0;">APPROVED <small>DATE: 12/30/2021</small></p> <p style="font-size: 8px; margin: 0;">12/30/2021</p>   </div> <p style="text-align: right; margin-top: 20px;">Cutsheets</p>
 <p>APPLICABLE CODES: 2017 NORTH CAROLINA ELECTRICAL CODE 2018 NORTH CAROLINA BUILDING CODE 2018 NORTH CAROLINA FIRE CODE 2018 NORTH CAROLINA RESIDENTIAL CODE</p>	<p>DESCRIPTION OF DESIGN: INSTALLATION OF GRID TIED, UTILITY INTERACTIVE PHOTOVOLTAIC SYSTEM.</p> <p>EQUIPMENT: DC SYSTEM SIZE: 14.04 KW (39) PV Modules: Solaria PowerXT 360R-PD AC SYSTEM SIZE: 11.4 KW (1) Inverter: SE11400H-US</p>	
<p>ADDRESS: Ruth Frame 1296 Young Rd Angier NC 27501</p>	<p>CONTRACTOR: GAF Energy LLC (NC) 973.628.3411 125 Mitchell Blvd, Suite D U.33879 San Rafael CA 94903</p>	<p>EQUIPMENT: 14.04 KW (DC) 11.4 KW (AC) (39) Solaria PowerXT 360R-PD (1) SolarEdge SE11400H-US (240V)</p> <p>DATE 9/16/2021 REV 0</p> <p>PV1 COVER PAGE</p> <p>BY: CBennett</p>



MP#1	Pitch:	8.5	/12
	Azimuth:	154	°
MP#2	Pitch:	9.5	/12
	Azimuth:	65	°

↑
NORTH

EQUIPMENT LEGEND

-  UTILITY METER
-  MAIN SERVICE PANEL
-  LOAD CENTER
-  AC DISCONNECT
-  METER SOCKET (FOR UTILITY PV METER)
-  INVERTER
-  JUNCTION BOX
-  BATTERY(IES)
-  FIRE ACCESS PATHWAY (3' TYP.)

ADDRESS: Ruth Frame 1296 Young Rd Angier NC 27501	CONTRACTOR: GAF Energy LLC (NC) 973.628.3411 U.33879 125 Mitchell Blvd, Suite D San Rafael CA 94903	EQUIPMENT: 14.04 KW (DC) 39 Solaria PowerXT 360R-PD 11.4 KW (AC) (1) SolarEdge SE11400H-US (240V)	DATE 9/16/2021 REV 0 PV2 SITE PLAN BY: CBennett
--	---	--	---

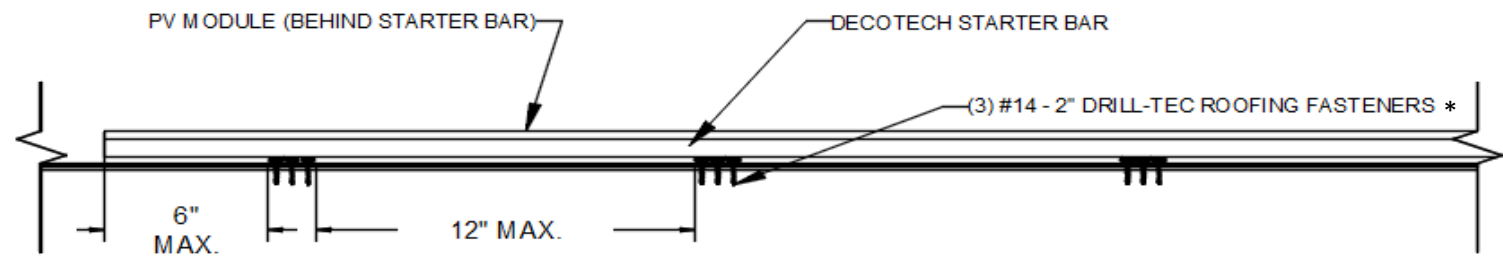
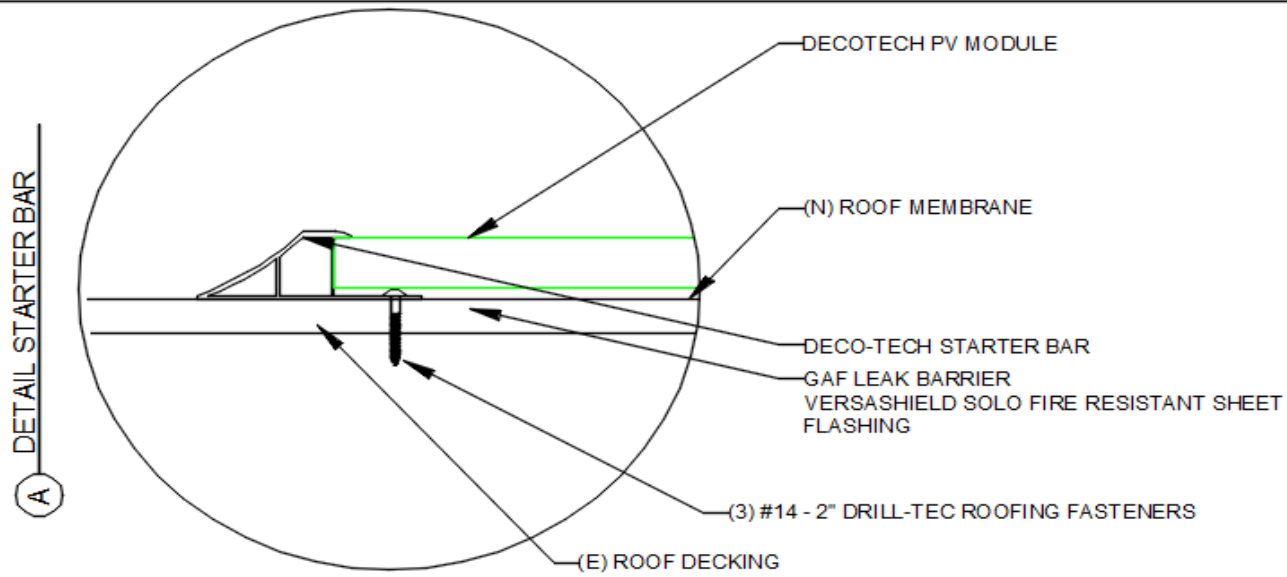

ARRAY DETAIL, FRONT VIEW

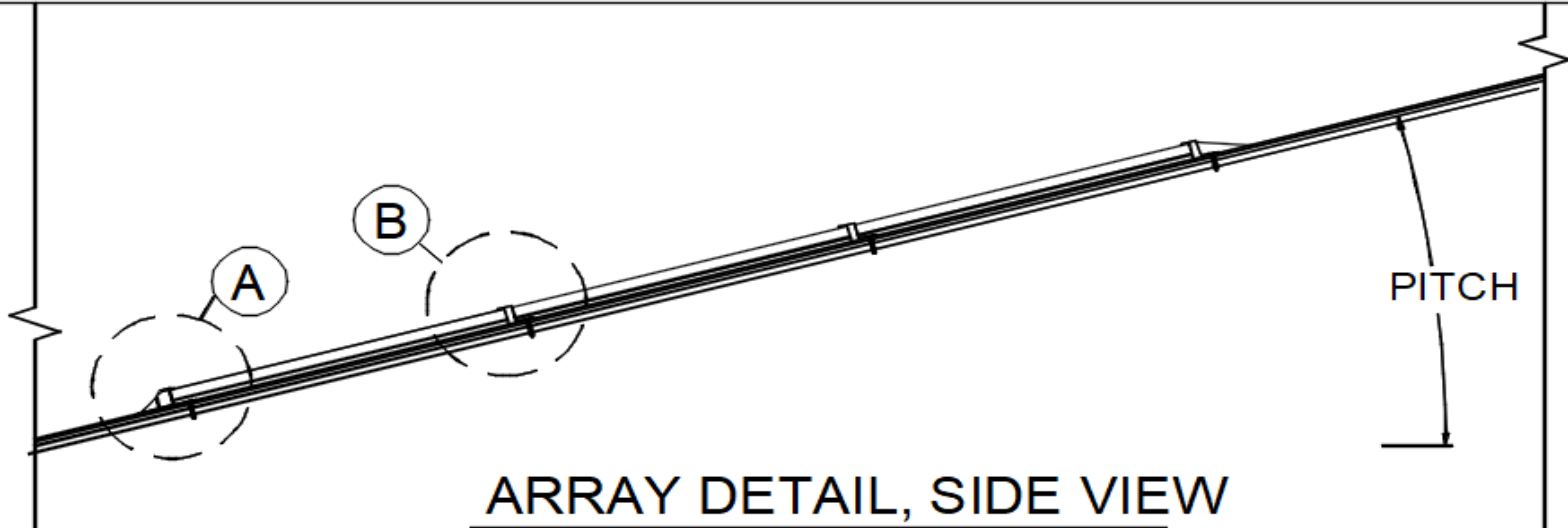
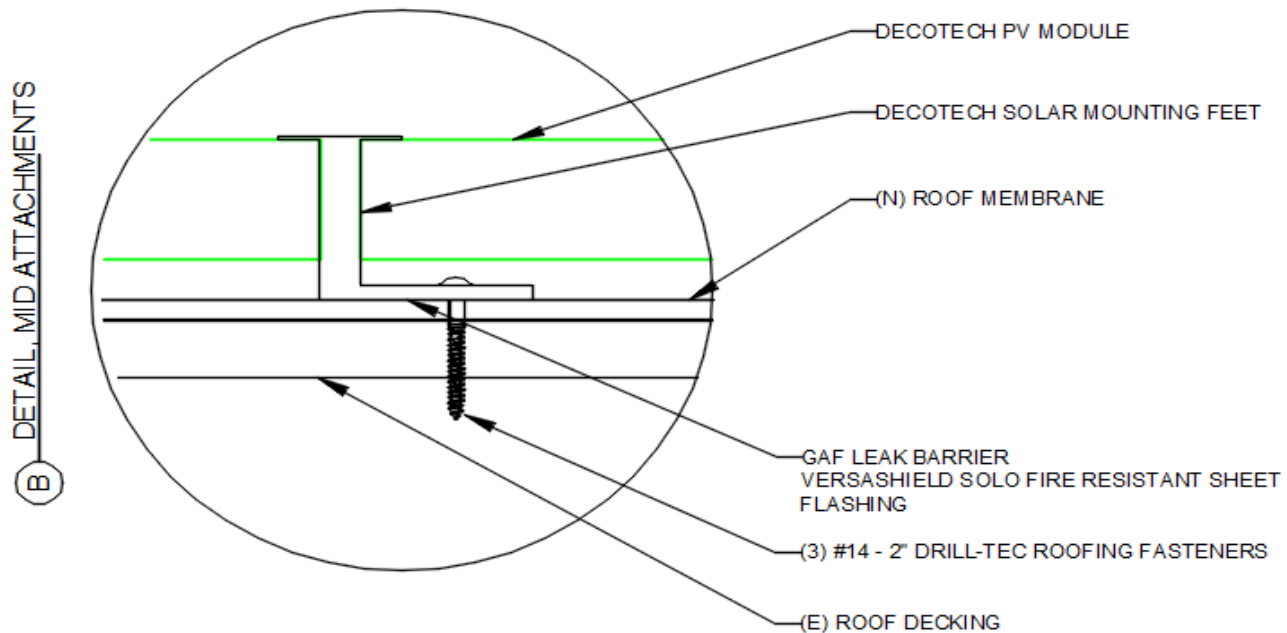

ARRAY DETAIL, SIDE VIEW

Roof deck type	* Fasteners per adjustable foot
Plywood	3 fasteners per foot
OSB	6 fasteners per foot



MP1 FRAMING DETAILS	
Rafter Size	2x4
Rafter Spacing	16
Framing Type	Stick Framing

MP2 FRAMING DETAILS	
Rafter Size	2x8
Rafter Spacing	24
Framing Type	Stick Framing

ADDRESS:	CONTRACTOR:	EQUIPMENT:	DATE	REV
Ruth Frame 1296 Young Rd Angier NC 27501	GAF Energy LLC (NC) 973.628.3411 U.33879 125 Mitchell Blvd, Suite D San Rafael CA 94903	14.04 KW (DC) 39 Solaria PowerXT 360R-PD 11.4 KW (AC) (1) SolarEdge SE11400H-US (240V)	9/16/2021	0
			PV3 MOUNTING DETAIL BY: CBennett	

WIRE SCHEDULE

1	(1) #10 AWG PV-WIRE, USE-2 COPPER (POS)	2	(1) #10 AWG THWN-2 (POS)	3	(1) #6 AWG THWN-2 (L1)	4	(1) #6 AWG THWN-2 (L1)	5		6	
	(1) #10 AWG PV-WIRE, USE-2 COPPER (NEG)		(1) #10 AWG THWN-2 (NEG)		(1) #6 AWG THWN-2 (L2)		(1) #6 AWG THWN-2 (L2)				
	(1) #12 AWG BARE, COPPER (GROUND)		(1) #10 AWG THWN-2 (GND)		(1) #6 AWG THWN-2 (NEUT)		(1) #6 AWG THWN-2 (NEUT)				
	(1) 3/4in EMT CONDUIT		(1) 3/4in EMT CONDUIT		(1) #10 AWG THWN-2 (GND)		(1) #10 AWG THWN-2 (GND)				
(OR CODE APPROVED EQUIVALENT)		(OR CODE APPROVED EQUIVALENT)		(OR CODE APPROVED EQUIVALENT)		(OR CODE APPROVED EQUIVALENT)		(OR CODE APPROVED EQUIVALENT)		(OR CODE APPROVED EQUIVALENT)	

V_{mp} (Vdc): 400 **I_{mp} (Adc):** 13.50
V_{oc} (Vdc): 480 **I_{sc} (Adc):** 30.50
V (Vac): 240 **I (Aac):** 47.5
Inverter 1

**250 ft Trench
- strings 1 and 3 are included**

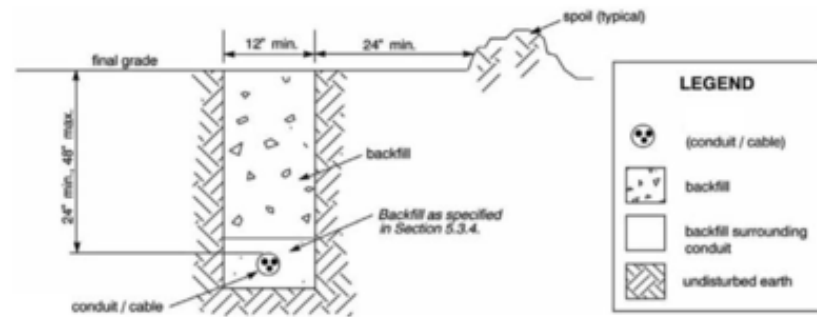

TYPICAL TRENCH DETAIL

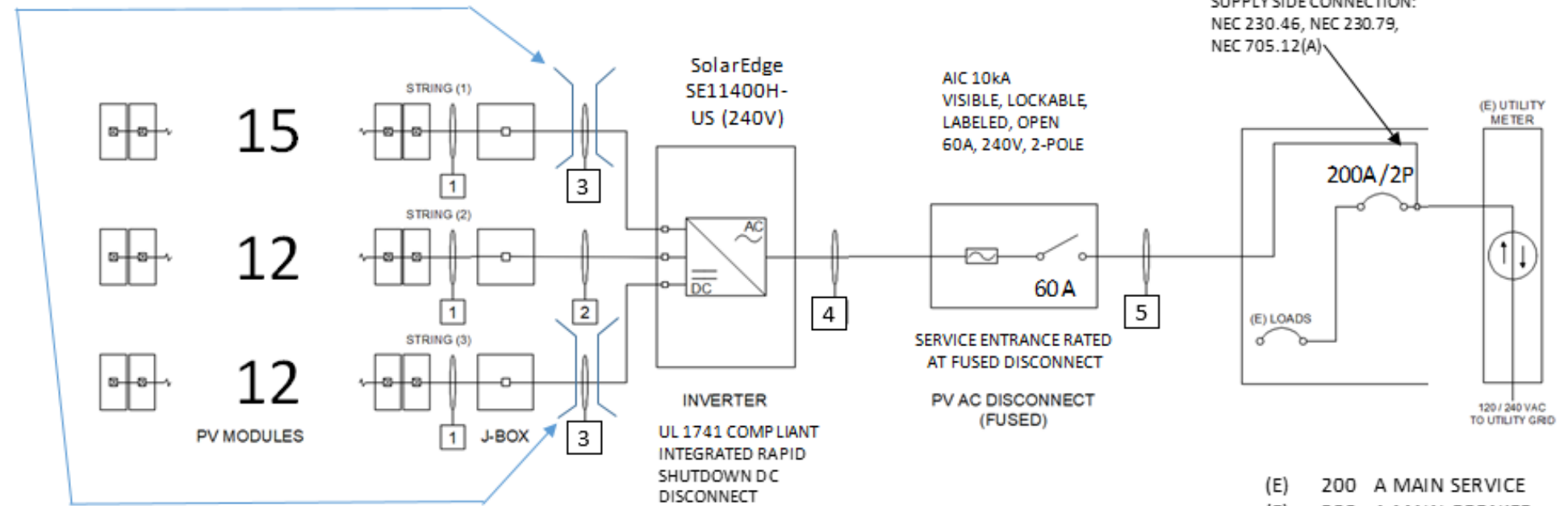

(E) 200 A MAIN SERVICE
(E) 200 A MAIN BREAKER

INTERCONNECTION NOTES

- GROUND FAULT PROTECTION IN ACCORDANCE WITH [NEC 215.9] & [NEC 230.95]
- SUPPLY SIDE INTERCONNECTION ACCORDING TO [NEC 705.12(A)] WITH SERVICE ENTRANCE CONDUCTORS IN ACCORDANCE WITH [NEC 240.21(B)]

DISCONNECT NOTES

- DISCONNECTING SWITCHES SHALL BE WIRED SUCH THAT WHEN THE SWITCH IS OPENED THE CONDUCTORS REMAINING LIVE ARE CONNECTED TO THE TERMINALS MARKED "LINE SIDE" (TYPICALLY THE UPPER TERMINALS)
- AC DISCONNECT MUST BE ACCESSIBLE TO QUALIFIED UTILITY PERSONNEL, BE LOCKABLE, AND BE A VISIBLE-BREAK SWITCH

GROUNDING & GENERAL NOTES

- A SECOND FACILITY GROUNDING ELECTRODE IS NOT REQUIRED PER [NEC 690.47(C)(3)]
- PV INVERTER IS UNGROUNDED, TRANSFORMER-LESS TYPE.
- DC GEC AND AC EGC TO REMAIN UNSPLICED, OR SPLICED TO EXISTING ELECTRODE
- ANY EXISTING WIRING INVOLVED WITH PV SYSTEM CONNECTION THAT IS FOUND TO BE INADEQUATE PER CODE SHALL BE CORRECTED PRIOR TO FINAL INSPECTION.
- JUNCTION BOX QUANTITIES, AND PLACEMENT SUBJECT TO CHANGE IN THE FIELD - JUNCTION BOXES DEPICTED ON ELECTRICAL DIAGRAM REPRESENT WIRE TYPE TRANSITIONS.
- AC DISCONNECT NOTED IN EQUIPMENT SCHEDULE OPTIONAL IF OTHER AC DISCONNECTING MEANS IS LOCATED WITHIN 10' OF SERVICE DISCONNECT.
- SOLAREGE INVERTERS WHEN USED WILL INCLUDE RS-485 OR ETHERNET COMMUNICATIONS PORT.

EQUIPMENT SCHEDULE

TYPE	QTY	DESCRIPTION	RATING
PV Modules	(39)	Solaria PowerXT 360R-PD	360W
DC Optimizers	(39)	P370	15Adc
Inverter	(1)	SolarEdge SE11400H-US (240V)	11400W

ADDRESS: Ruth Frame 1296 Young Rd Angier NC 27501	CONTRACTOR: GAF Energy LLC (NC) 973.628.3411 U.33879	EQUIPMENT: 14.04 KW (DC) 39 Solaria PowerXT 360R-PD	DATE 9/16/2021 REV 0 11.4 KW (AC) (1) SolarEdge SE11400H-US (240V)
			BY: CBennett

CAUTION

POWER TO THIS BUILDING IS ALSO SUPPLIED FROM ROOF MOUNTED SOLAR ARRAYS WITH SAFETY DISCONNECTS SHOWN:

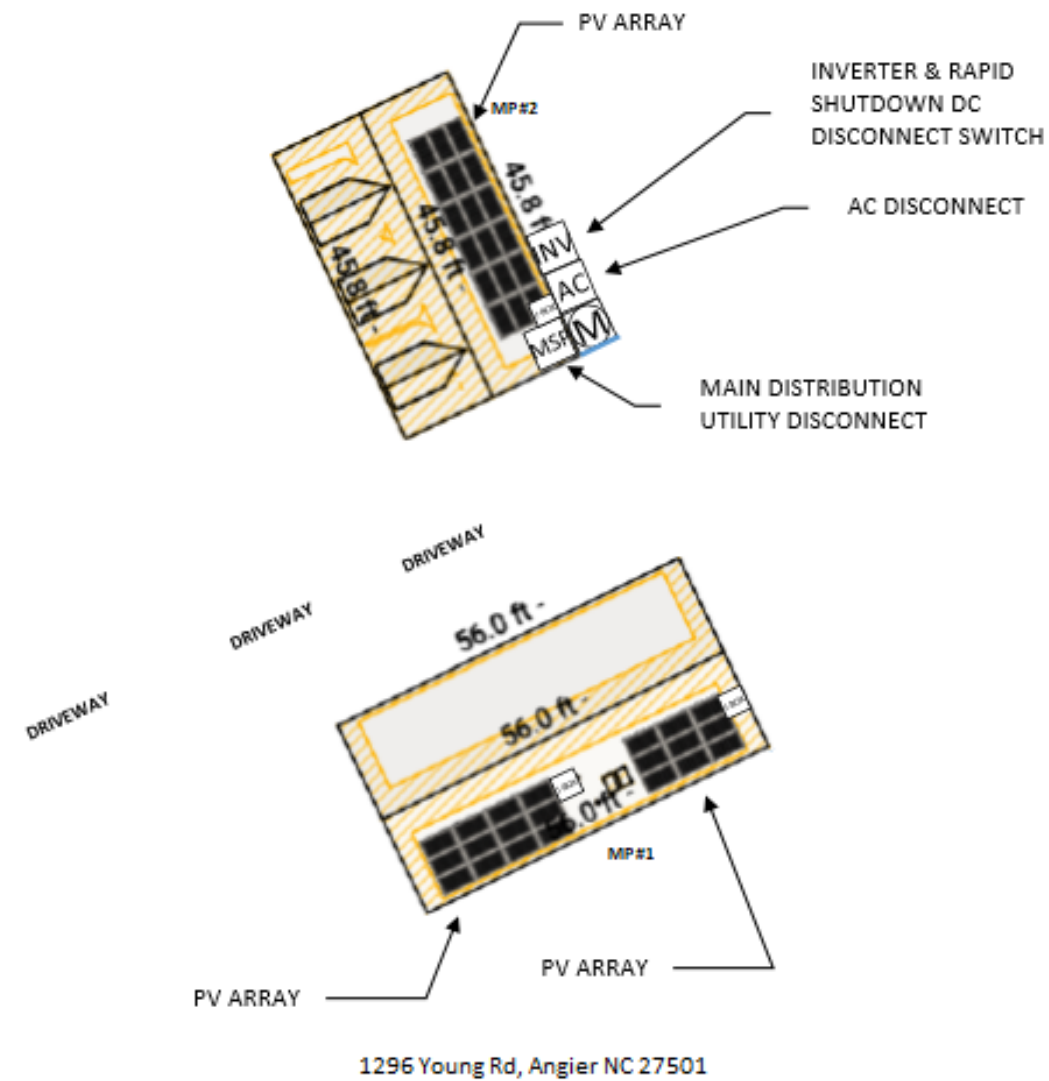

ADDRESS: Ruth Frame 1296 Young Rd Angier NC 27501	CONTRACTOR: GAF Energy LLC (NC) 973.628.3411 U.33879	125 Mitchell Blvd, Suite D San Rafael CA 94903	EQUIPMENT: 14.04 KW (DC) 39 Solaria PowerXT 360R-PD	11.4 KW (AC) (1) SolarEdge SE11400H-US (240V)	DATE 9/16/2021 REV 0
					BY: CBennett

Single Phase Inverter with HD-Wave Technology

for North America

SE3000H-US / SE3800H-US / SE5000H-US / SE6000H-US / SE7600H-US / SE10000H-US / SE11400H-US

12-25
YEAR
WARRANTY



INVERTERS

Optimized installation with HD-Wave technology

- Specifically designed to work with power optimizers
- Record-breaking efficiency
- Fixed voltage inverter for longer strings
- Integrated arc fault protection and rapid shutdown for NEC 2014 and 2017, per article 690.11 and 690.12
- UL1741 SA certified, for CPUC Rule 21 grid compliance
- Extremely small
- Built-in module-level monitoring
- Outdoor and indoor installation
- Optional: Revenue grade data, ANSI C12.20 Class 0.5 (0.5% accuracy)

solaredge.com



Single Phase Inverter with HD-Wave Technology for North America

SE3000H-US / SE3800H-US / SE5000H-US / SE6000H-US / SE7600H-US / SE10000H-US / SE11400H-US

	SE3000H-US	SE3800H-US	SE5000H-US	SE6000H-US	SE7600H-US	SE10000H-US	SE11400H-US		
OUTPUT									
Rated AC Power Output	3000	3800 @ 240V 3300 @ 208V	5000	6000 @ 240V 5000 @ 208V	7600	10000	11400 @ 240V 10000 @ 208V	VA	
Maximum AC Power Output	3000	3800 @ 240V 3300 @ 208V	5000	6000 @ 240V 5000 @ 208V	7600	10000	11400 @ 240V 10000 @ 208V	VA	
AC Output Voltage Min.-Nom.-Max. (211 - 240 - 264)	✓	✓	✓	✓	✓	✓	✓	Vac	
AC Output Voltage Min.-Nom.-Max. (183 - 208 - 229)	-	✓	-	✓	-	-	✓	Vac	
AC Frequency (Nominal)	59.3 - 60 - 60.5 ¹⁾							Hz	
Maximum Continuous Output Current @240V	12.5	16	21	25	32	42	47.5	A	
Maximum Continuous Output Current @208V	-	16	-	24	-	-	48.5	A	
GFDI Threshold	1							A	
Utility Monitoring, Islanding Protection, Country Configurable Thresholds	Yes								
INPUT									
Maximum DC Power @240V	4650	5900	7750	9300	11800	15500	17650	W	
Maximum DC Power @208V	-	5100	-	7750	-	-	15500	W	
Transformer-less, Ungrounded	Yes								
Maximum Input Voltage	480							Vdc	
Nominal DC Input Voltage	380				400			Vdc	
Maximum Input Current @240V ²⁾	8.5	10.5	13.5	16.5	20	27	30.5	Adc	
Maximum Input Current @208V ²⁾	-	9	-	13.5	-	-	27	Adc	
Max. Input Short Circuit Current	45							Adc	
Reverse-Polarity Protection	Yes								
Ground-Fault Isolation Detection	600ka Sensitivity								
Maximum Inverter Efficiency	99	99.2						%	
CEC Weighted Efficiency	99						99 @ 240V 98.5 @ 208V	%	
Nighttime Power Consumption	< 2.5							W	
ADDITIONAL FEATURES									
Supported Communication Interfaces	RS485, Ethernet, ZigBee (optional), Cellular (optional)								
Revenue Grade Data, ANSI C12.20	Optional ³⁾								
Rapid Shutdown - NEC 2014 and 2017 690.12	Automatic Rapid Shutdown upon AC Grid Disconnect								
STANDARD COMPLIANCE									
Safety	UL1741, UL1741 SA, UL1699B, CSA C22.2, Canadian AFCI according to T.I.L. M-07								
Grid Connection Standards	IEEE1547, Rule 21, Rule 14 (H)								
Emissions	FCC Part 15 Class B								
INSTALLATION SPECIFICATIONS									
AC Output Conduit Size / AWG Range	1" Maximum / 14-6 AWG				1" Maximum / 14-4 AWG				
DC Input Conduit Size / # of Strings / AWG Range	1" Maximum / 1-2 strings / 14-6 AWG				1" Maximum / 1-3 strings / 14-6 AWG				
Dimensions with Safety Switch (HxWxD)	17.7 x 14.6 x 6.8 / 450 x 370 x 174				21.3 x 14.6 x 7.3 / 540 x 370 x 185				in / mm
Weight with Safety Switch	22 / 10	25.1 / 11.4	26.2 / 11.9	38.8 / 17.6				lb / kg	
Noise	< 25				< 50				dBA
Cooling	Natural Convection								
Operating Temperature Range	-13 to +140 / -25 to +60 ⁴⁾ (-40°F / -40°C option) ⁵⁾							°F / °C	
Protection Rating	NEMA 4X (Inverter with Safety Switch)								

¹⁾ For other regional settings please contact SolarEdge support

²⁾ A higher current source may be used; the inverter will limit its input current to the values stated

³⁾ Revenue grade inverter P/N: SExxxxH-US000NNC2

⁴⁾ For power de-rating information refer to: <https://www.solaredge.com/sites/default/files/se-temperature-derating-note-na.pdf>

⁵⁾ -40 version P/N: SExxxxH-US000NNU4

Power Optimizer

For North America

P320 / P340 / P370 / P400 / P405 / P505



POWER OPTIMIZER

PV power optimization at the module-level

- Specifically designed to work with SolarEdge inverters
- Up to 25% more energy
- Superior efficiency (99.5%)
- Mitigates all types of module mismatch losses, from manufacturing tolerance to partial shading
- Flexible system design for maximum space utilization
- Fast installation with a single bolt
- Next generation maintenance with module-level monitoring
- Meets NEC requirements for arc fault protection (AFCI) and Photovoltaic Rapid Shutdown System (PVRSS)
- Module-level voltage shutdown for installer and firefighter safety

solaredge.com



Power Optimizer For North America

P320 / P340 / P370 / P400 / P405 / P505

Optimizer model (typical module compatibility)	P320 (for 60-cell modules)	P340 (for high-power 60-cell modules)	P370 (for higher-power 60 and 72-cell modules)	P400 (for 72 & 96-cell modules)	P405 (for thin film modules)	P505 (for higher current modules)	
INPUT							
Rated Input DC Power ⁽¹⁾	320	340	370	400	405	505	W
Absolute Maximum Input Voltage (Voc at lowest temperature)	48		60	80	125 ⁽²⁾	87 ⁽²⁾	Vdc
MPPT Operating Range	8 - 48		8 - 60	8 - 80	12.5 - 105	12.5 - 87	Vdc
Maximum Short Circuit Current (Isc)	11			10.1		14	Adc
Maximum DC Input Current	13.75			12.5		17.5	Adc
Maximum Efficiency	99.5						%
Weighted Efficiency	98.8					98.6	%
Overvoltage Category	II						
OUTPUT DURING OPERATION (POWER OPTIMIZER CONNECTED TO OPERATING SOLAREEDGE INVERTER)							
Maximum Output Current	15						Adc
Maximum Output Voltage	60			85			Vdc
OUTPUT DURING STANDBY (POWER OPTIMIZER DISCONNECTED FROM SOLAREEDGE INVERTER OR SOLAREEDGE INVERTER OFF)							
Safety Output Voltage per Power Optimizer	1 ± 0.1						Vdc
STANDARD COMPLIANCE							
EMC	FCC Part15 Class B, IEC61000-6-2, IEC61000-6-3						
Safety	IEC62109-1 (class II safety), UL1741						
Material	UL94 V-0, UV Resistant						
RoHS	Yes						
INSTALLATION SPECIFICATIONS							
Maximum Allowed System Voltage	1000						Vdc
Compatible inverters	All SolarEdge Single Phase and Three Phase inverters						
Dimensions (W x L x H)	129 x 153 x 27.5 / 5.1 x 6 x 1.1		129 x 153 x 33.5 / 5.1 x 6 x 1.3	129 x 159 x 49.5 / 5.1 x 6.3 x 1.9	129 x 162 x 59 / 5.1 x 6.4 x 2.3		mm / in
Weight (including cables)	630 / 1.4		750 / 1.7	845 / 1.9	1064 / 2.3		gr / lb
Input Connector	Single or dual MC4 ⁽³⁾						
Input Wire Length	0.16 / 0.52						m / ft
Output Wire Type / Connector	Double Insulated / MC4						
Output Wire Length	0.9 / 2.95		1.2 / 3.9				m / ft
Operating Temperature Range	-40 - +85 / -40 - +185						°C / °F
Protection Rating	IP68 / NEMA6P						
Relative Humidity	0 - 100						%

⁽¹⁾ Rated power of the module at STC will not exceed the optimizer "Rated Input DC Power". Modules with up to +5% power tolerance are allowed

⁽²⁾ NEC 2017 requires max input voltage be not more than 80V

⁽³⁾ For other connector types please contact SolarEdge

PV System Design Using a SolarEdge Inverter ⁽⁴⁾⁽⁵⁾	Single Phase HD-Wave	Single phase	Three Phase 208V	Three Phase 480V	
Minimum String Length (Power Optimizers)	P320, P340, P370, P400	8	10	18	
	P405 / P505	6	13 (12 with SE3K)	14	
Maximum String Length (Power Optimizers)		25	25	50 ⁽⁶⁾	
Maximum Power per String	5700 (6000 with SE7600-US - SE11400-US)	5250	6000 ⁽⁷⁾	12750 ⁽⁸⁾	W
Parallel Strings of Different Lengths or Orientations	Yes				

⁽⁴⁾ For detailed string sizing information refer to: http://www.solaredge.com/sites/default/files/string_sizing_na.pdf

⁽⁵⁾ It is not allowed to mix P405/P505 with P320/P340/P370/P400 in one string

⁽⁶⁾ A string with more than 30 optimizers does not meet NEC rapid shutdown requirements; safety voltage will be above the 30V requirement

⁽⁷⁾ For SE14.4KUS/SE43.2KUS: It is allowed to install up to 6,500W per string when 3 strings are connected to the inverter (3 strings per unit for SE43.2KUS) and when the maximum power difference between the strings is up to 1,000W

⁽⁸⁾ For SE30KUS/SE33.3KUS/SE66.6KUS/SE100KUS: It is allowed to install up to 15,000W per string when 3 strings are connected to the inverter (3 strings per unit for SE66.6KUS/SE100KUS) and when the maximum power difference between the strings is up to 2,000W

© SolarEdge Technologies Ltd. All rights reserved. SOLAREEDGE, the SolarEdge logo, OPTIMIZED BY SOLAREEDGE are trademarks or registered trademarks of SolarEdge Technologies, Inc. All other trademarks mentioned herein are trademarks of their respective owners. Date: 07/2019/V01/ENG NAM. Subject to change without notice.

CE RoHS



Solar Energy System



Solar Energy System

TECH DATA

Dimensions

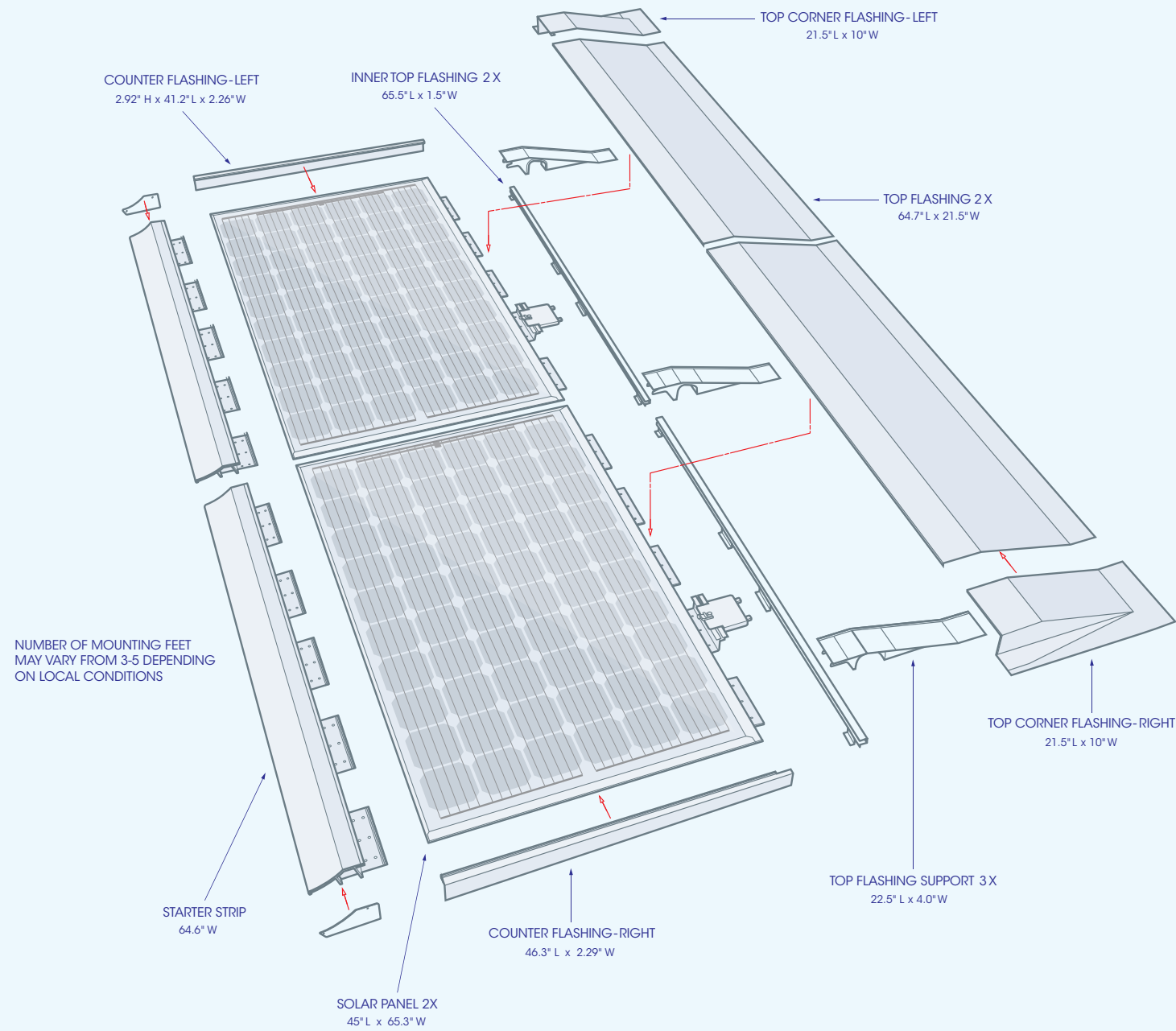

Description

The sleek, low-profile design of the GAF Energy solar energy system delivers performance and curb appeal at an affordable price.

Product Installation

Refer to the Application Instructions for details on how to install the GAF Energy solar energy system.



Design Considerations

- GAF Energy solar energy system must be installed in landscape orientation.
- Certified for direct attachment to roof deck. The roof deck must be a minimum of 15/32" thick plywood or 7/16" thick OSB.
- System is installed directly to the roof deck without engaging rafters.
- GAF Energy solar energy system is intended for use solely on roofs having a slope between 4:12 and 12:12.
- DC optimizers and AC inverters can be used.
- Asphalt shingle installations only.

Technical Specifications

Model Number	GAF Solar Energy System	Cells per module	60
PV Laminate	Solaria PowerXT	Cell type	Monocrystalline
Maximum Power under STC* (Pmax)	360 Wp	PV Connector Type	PV wire with MC4 compatible
Open Circuit Voltage under STC (Voc)	47.7 V	PV Laminate Front	3.2 mm high transmittance, tempered, ar coating
Maximum Power Point Voltage under STC (Vmpp)	39.5 V	PV Laminate Back	Multi-layer Polymer Backsheet
Short Circuit Current under STC (Isc)	9.56 A	Frame	Black Powder Coated Aluminum
Maximum Power Point Current under STC (Impp)	9.13 A	Weight	40.0 lb. (22.2 kg)
Module Efficiency under STC (ηm)	19.9%	Operating Temperatures	-40 to +185°F (-40 to +85°C)
Temperature Correction Factor TC Voc	-0.29%/C	Design Loading	50 lb./ft² (244 kg/m²) Positive Design Load
		Certifications	PowerXT-360-R-PD-L UL 1703
		Fire Rating	UL 2703 Class A



*STC: Standard Test Conditions 1000W/m², 25°C, AM 1.5. For additional parameters and certifications, refer to the latest version of the GAF Energy solar system Application Instructions