

# LG NeON<sup>®</sup>R

LG395Q1C-A6

60

## 395W

LG NeON<sup>®</sup>R is a powerful solar module that provides world-class performance. A new cell structure that eliminates electrodes on the front maximizes the utilization of light and enhances reliability.

LG NeON<sup>®</sup>R is a result of LG's efforts to increase customer's values beyond efficiency. LG NeON<sup>®</sup>R features enhanced durability, performance under real-world conditions, an enhanced warranty and aesthetic design suitable for roofs.

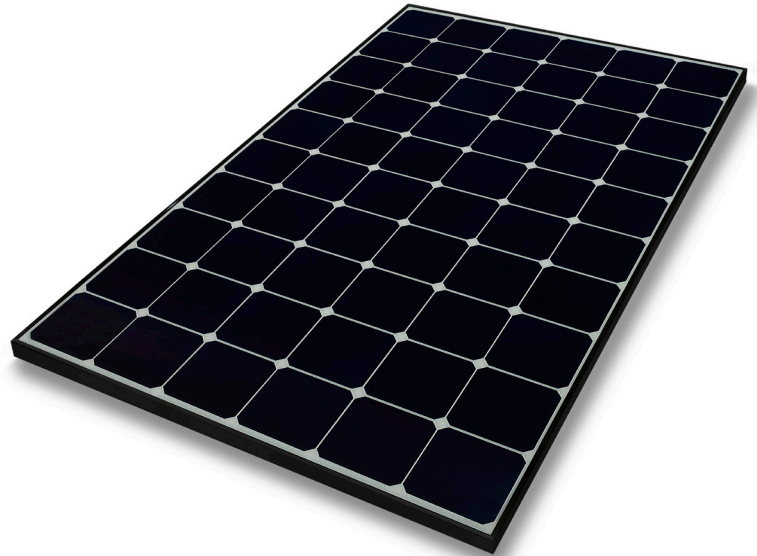

## Features



### Roof Aesthetics

LG NeON<sup>®</sup>R has been designed with aesthetics in mind: the lack of any electrodes on the front creates an improved, modern aesthetic.



### 25-Year Limited Product Warranty

The NeON<sup>®</sup>R is covered by a 25-year limited product warranty. In addition, up to \$450 of labor costs will be covered in the rare case that a module needs to be repaired or replaced.



### Enhanced Performance Warranty

The LG NeON<sup>®</sup>R has an enhanced performance warranty. After 25 years, LG NeON<sup>®</sup>R is guaranteed at least 92.5% of initial performance.



### More generation per square meter

The LG NeON<sup>®</sup>R has been designed to significantly enhance its output, making it efficient even in limited space.

When you go solar, ask for the brand you can trust: LG Solar

## About LG Electronics USA, Inc.

LG Electronics is a global leader in electronic products in the clean energy markets by offering solar PV panels and energy storage systems. The company first embarked on a solar energy source research program in 1985, supported by LG Group's vast experience in the semi-conductor, LCD, chemistry and materials industries. In 2010, LG Solar successfully released its first MonoX<sup>®</sup> series to the market, which is now available in 32 countries. The NeON<sup>®</sup> (previous MonoX<sup>®</sup> NeON), NeON<sup>®</sup>2, NeON<sup>®</sup>2 BiFacial won the "Intersolar AWARD" in 2013, 2015 and 2016, which demonstrates LG's leadership and innovation in the solar industry.



## LG395Q1C-A6

### General Data

Cell Properties (Material/Type)	Monocrystalline / N-type
Cell Maker	LG
Cell Configuration	60 Cells (6 x 10)
Module Dimensions (L x W x H)	1,740mm x 1,042mm x 40mm
Weight	18.5 kg
Glass (Material)	Tempered Glass with AR Coating
Backsheet (Color)	White
Frame (Material)	Anodized Aluminium
Junction Box (Protection Degree)	IP 68 with 3 Bypass Diodes
Cables (Length)	1,250mm x 2EA
Connector (Type/Maker)	MC 4 / MC

### Certifications and Warranty

Certifications*	IEC 61215-1/-1-1/2 : 2016, IEC 61730-1/2: 2016, UL 61730-1 : 2017, UL 61730-2 : 2017
	ISO 9001, ISO 14001, ISO 50001
	OHSAS 18001
Salt Mist Corrosion Test	IEC 61701:2012 Severity 6
Ammonia Corrosion Test	IEC 62716 : 2013
Module Fire Performance	Type 1 (UL 61730)
Fire Rating	Class C (UL 790, ULC / ORD C 1703)
Solar Module Product Warranty	25 Years
Solar Module Output Warranty	Linear Warranty*

\*Improved: 1<sup>st</sup> year 98.5%, from 2-24th year: -0.25%/year down, 92.5% at year 25

### Temperature Characteristics

NMOT*	[°C]	44 ± 3
Pmax	[%/°C]	-0.29
Voc	[%/°C]	-0.24
Isc	[%/°C]	0.04

\*NMOT (Nominal Module Operating Temperature): Irradiance 800 W/m<sup>2</sup>, Ambient temperature 20°C, Wind speed 1 m/s, Spectrum AM 1.5

### Electrical Properties (NMOT)

Model	LG395Q1C-A6	
Maximum Power (Pmax)	[W]	299
MPP Voltage (Vmpp)	[V]	34.9
MPP Current (Impp)	[A]	8.57
Open Circuit Voltage (Voc)	[V]	41.6
Short Circuit Current (Isc)	[A]	9.10

### I-V Curves

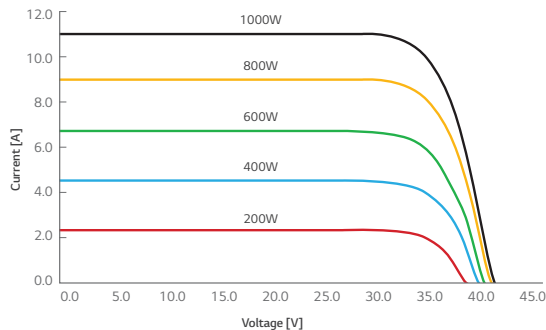

### Electrical Properties (STC\*)

Model	LG395Q1C-A6	
Maximum Power (Pmax)	[W]	395
MPP Voltage (Vmpp)	[V]	37.0
MPP Current (Impp)	[A]	10.69
Open Circuit Voltage (Voc, ± 5%)	[V]	43.6
Short Circuit Current (Isc, ± 5%)	[A]	11.29
Module Efficiency	[%]	21.8
Power Tolerance	[%]	0 ~ +3

\*STC (Standard Test Condition): Irradiance 1000 W/m<sup>2</sup>, Cell temperature 25°C, AM 1.5  
Measure Tolerance: ± 3%

### Operating Conditions

Operating Temperature*	[°C]	-40 ~ +85
Maximum System Voltage	[V]	1,000
Maximum Series Fuse Rating	[A]	20
Mechanical Test Load** (Front)	[Pa/psf]	5,400
Mechanical Test Load** (Rear)	[Pa/psf]	4,000

\*The operating ambient temperature of these devices may exceed 40°C at full load for all wire sizes if it is determined suitable in the field use application.

\*\*Based on IEC 61215-2 : 2016 (Test Load = Design Load x Safety Factor (1.5))

### Packaging Configuration

Number of Modules per Pallet	[EA]	25
Number of Modules per 40' Container	[EA]	650
Number of Modules per 53' Container	[EA]	850
Packaging Box Dimensions (L x W x H)	[mm]	1,790 x 1,120 x 1,227
Packaging Box Dimensions (L x W x H)	[in]	70.5 x 44.1 x 48.3
Packaging Box Gross Weight	[kg]	498
Packaging Box Gross Weight	[lb]	1,098

### Dimensions (mm/inch)

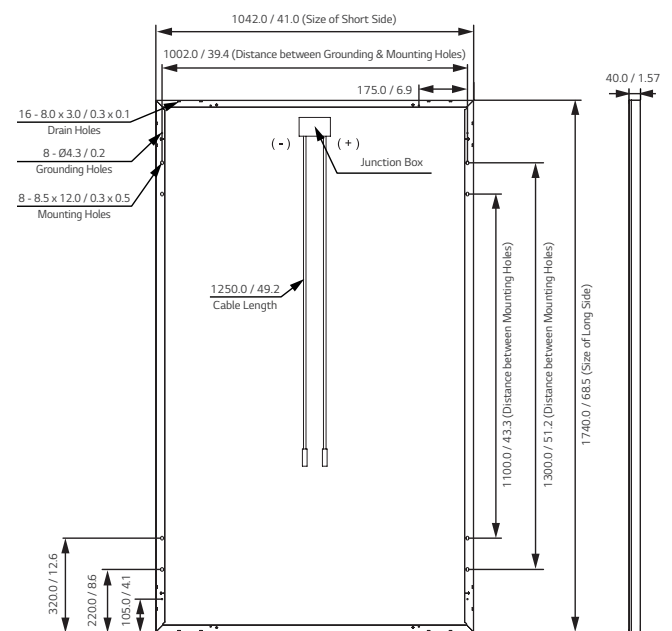

Installation manual

# PV Solar MODULE

Please read this manual carefully before operating your set and retain it for future reference.

**N-TYPE MODELS**

LGXXXN1C(W,K)-V5

LGXXXN2W-V5

# TABLE OF CONTENTS

<b>SAFETY</b> .....	<b>03</b>
<b>BEFORE &amp; AFTER INSTALLATION</b> .....	<b>05</b>
Before Installation.....	05
After Installation.....	05
<b>ELECTRICAL INSTALLATION</b> .....	<b>06</b>
Danger.....	06
Electrical Connections.....	06
Diodes .....	06
Series Connection .....	06
Parallel Connection .....	07
General Wiring.....	07
Earth Grounding .....	07
<b>MECHANICAL INSTALLATION</b> .....	<b>08</b>
Module Mounting.....	08
Site Consideration .....	08
Mounting Methods.....	08
<b>DISCLAIMER OF LIABILITY / DISPOSAL</b> .....	<b>10</b>
<b>TRANSPORTING AND STORAGE</b> .....	<b>10</b>
<b>REVISIONS TABLE</b> .....	<b>10</b>
<b>PRODUCT SPECIFICATIONS</b> .....	<b>11</b>
Electrical & Mechanical Properties.....	11
Dimensions of Modules .....	12
<b>APPENDIX</b> .....	<b>13</b>
Mechanical Installation methods.....	13
Bolting & Clamp Information.....	15
Alternate Equipment Grounding Devices.....	16
Unloading Flow Guide.....	17



# SAFETY

The instructions related to safety and use indicated in this installation manual are intended for the prevention of unexpected danger, damage, or failure.

**⚠ DANGER**   **⚠ WARNING**   **⚠ CAUTION**

Non-compliance with the instructions may cause product damage, product failure, and/or serious bodily injury or death.

**⚠ DANGER**

Do not contact electrically active parts of the panel, such as terminals, without appropriate safety gear. Contact may result in lethal spark or electric shock.

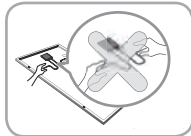

Do not use or install if the module is broken or torn. Failure to comply may result in electric shock.

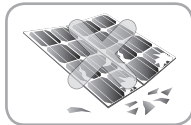

**⚠ WARNING**

Perform all work in dry conditions and use only dry tools. Do not handle wet panels without appropriate protection equipment. Failure to comply may result in accident or death.

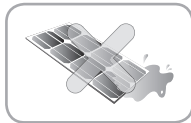

Damaged modules must be treated with safety protection equipment. Failure to comply may result in serious bodily injury or death.

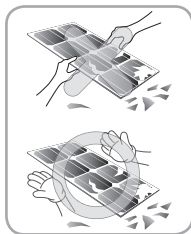

Do not approach the damaged or broken module unless you are an authorized or qualified expert. Failure to comply may result in serious bodily injury or death.

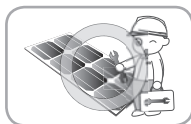

No electrical parts like cables are located after installation between laminate and mounting structure.



Do Not reconnect or repair junction box cable. It may occur spark or electric shock.

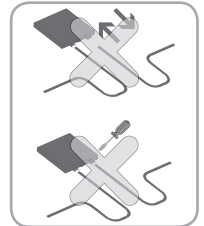

Do not bending junction box's cable. While under stress, it may occur module damage. Cable bending radius should be more than 4 times the cable diameter, at least.

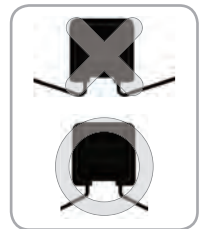

**⚠ CAUTION**

Use proper equipment, connectors, wires and buttsresses for the installation of the module. Failure to comply may result in product damage, product failure or bodily injury.

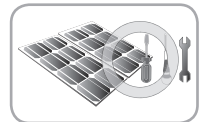

Installation during rain, heavy wind or snowy day may result in bodily injury or death.

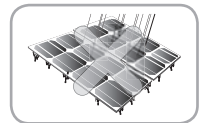

Holes in the frame or glass of the module may decrease the strength of the frame or break the glass.



Do not touch the glass surface or frame of the solar module after installation of the module. It may result in injury or death.

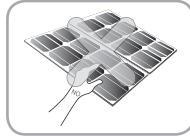

Heavy objects must be kept off of the solar module.



Do not stand on or step on the module. Do not drop the module.

Failure to comply may result in product damage, product failure or bodily injury.

Do not scratch the coating surface of the frame.

Scratches may decrease the total solar output due to corrosion of the frame.

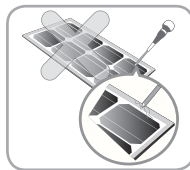

Do not artificially concentrate sunlight on the solar module surface. Failure to comply may result in product damage or failure.

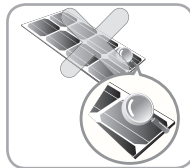

Do not apply a shock to the junction box of the module or pull the cable. Do not remove the labels attached to the module.

Failure to comply may result in damage of the product.

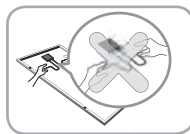

If the installing modules on curved surface, (e. g. arch type), as shown in the below picture, do not forcefully modify the module in the installation when connecting it with the structure. Only install the module in the place where the structure for the panels has been properly set up. An improper structure may cause deformation of the panels. Panels may also be damaged by unapproved installation methods such as the use of a crane.

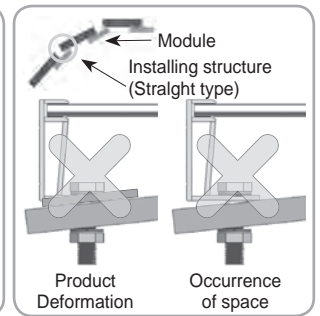
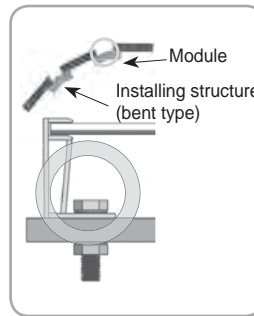

Partial shadow must be removed from solar module because it can cause severe problems of solar module.



# BEFORE & AFTER INSTALLATION

## Before Installation

Please carefully read this manual before installation.

- Solar module installation and maintenance must be performed by qualified and authorized installer.
- All installation instructions should be read and understood before performing any installation.
- Do not touch the solar module with bare hands. It may result in a burn or injury.
- Do not disassemble the solar module.
- After installation or repair, check that the solar module are operating properly.
- In the event that the currently used solar module or parts have been replaced the newly replaced module and parts must have the same model name and parts as the previously installed solar module.
- Do not let anyone approach the solar module who has little knowledge of solar modules or on the measures to take when solar modules are damaged in order to avoid the risk of injury or electrical shock.
- Secure all necessary permits and licenses to install the solar modules.
- Do not locate the solar module horizontally, as this may cause dirt or white efflorescence(glass deformation).
- Panels are not intended for use indoors or on moving vehicles of any kind.
- Industry standard rated specifications are made at conditions of 1000W/m<sup>2</sup> irradiance and 25°C (77°F) solar cell temperature. Colder temperatures may substantially increase voltage and power.
- Keep the solar module and system away from children at all times.
- Keep the module packed in the carton until the time of installation.
- Keep flammable gasses away from the installation site.
- Do not work alone. Please work as part of a team of two or more people.
- Safety harness use is strongly recommended for installation.
- Be careful not to damage the cable when using a tool such as a knife to remove the cable tie that fixes the junction box cable.

- Partial shadowing may substantially reduce panel and system output and may be the reason for the damage of solar module.
- Care must be taken to avoid low tilt angles which may cause dirt to buildup on the glass against the frame edge.
- Dirt build-up on the surface of the panel may cause active solar cells to be shaded and electrical performance to be impaired.

## After Installation

- Plug in the connector tightly and ensure that the wiring properly works.
- Conduct periodic inspection of the panels for damage to front glass, back sheet, frame, junction box, or external electrical connections.
- Check electrical connections for loose connections and corrosion.
- PV panels can operate effectively without ever being washed, although removal of dirt from the front glass can increase output.
- Water, ethanol or a conventional glass cleanser with a micro-fiber cloth can be used for regular washing or rinsing of the front glass to remove dust, dirt or other deposits.
- Do not use ground water containing calcium carbonate components when cleaning glass.
- Aggressive and abrasive cleansers or chemicals such as alkali chemicals including ammonia based solution should not be used on cleaning the module.
- Always keep the back surface of the panel free from any foreign objects or structural elements which could come into contact with the panel, especially when the panel is under mechanical load.
- Deposits of foreign material on the frame surface can be cleaned by using a wet sponge or cloth and dried in air or by using a clean chamois.
- Perform the wiring work by connecting the connector and wires to the stand away from the roof or ground.
- Do not use any kind of oil or lubricant on the module's any parts, It can defect the PV Module.

# ELECTRICAL INSTALLATION

## Danger

- Avoid all electrical hazards when installing, wiring, operating and maintaining all panels.
- Do not connect panels that have different electrical properties or physical configurations in the same system.
- Match the polarities of cables and terminals when making the connections; failure to do so may result in damage to the panel.
- The rating of the over-current device shall not exceed the maximum series fuse rating marked on the name plate.
- The panel contains factory installed bypass diodes located inside the junction box.
- When installing the system, it is recommended to install a lightning rod to protect the system.
- The induced overvoltage by lightning can cause the system damage, you should design conductor loop connection as minimum as possible.
- The junction box should not be opened. Opening the junction box will void the warranty.
- Panels with a suspected electrical problem should be returned to LG Electronics for inspection and possible repair or replacement as per the warranty conditions provided by LG Electronics.

## Electrical Connections

- Shock hazard may occur near the solar modules electrical connections.
- Modules may be connected in series and/or parallel to achieve the desired electrical output as long as it is within the guidelines on the product specification sheet.
- Please use only the same type of modules in a combined source circuit.
- Do not disconnect the module under when it is operating. Shock hazard may occur near the solar modules connection means.
- When the module installing in series or in parallel (e.g. using for extension cables, etc.), the connector of each module should be the same products. (mated with its original female or male connector of the same supplier)

## Diodes

- All LG modules are equipped with factory installed bypass diodes. The factory-installed diodes provide proper circuit protection for the module from unexpected shadows.

$I_F$ (AV)	20A
$V_F$ (max)	0.8V
$V_{RRM}$	45V
$T_j$ (max)	200°C
$R_{TH}$	1.5°C/W

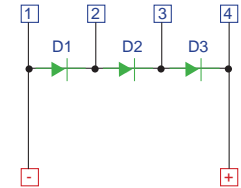

Diode specification and configuration

## Series Connection

- The solar modules may be wired in series to produce the desired voltage output.
- The current of each module connected in series should be the same.
- The maximum PV system voltage for that circuit shall be calculated as the sum of the rated open-circuit voltage of the series-connected PV modules corrected for the lowest expected ambient temperature. For the LG Mono crystalline modules, the rated open-circuit voltage shall be multiplied by the correction factor provided in NEC Table 690.7. The maximum current of Photovoltaic Source Circuit Currents shall be the rated short-circuit current of the series-connected module multiplied by 125 percent in accordance with NEC article 690.8.

## Parallel Connection

- The solar modules may be combined in parallel to produce the desired current output.
- When modules are combined in parallel, the total current is equal to the sum of currents from each module.
- The voltage of each module connected in parallel should be the same.
- When connecting plural strings of modules in parallel every series string or solar module must be fused prior to combining with other strings.
- Abide with all applicable federal, state, and local codes for additional fusing requirements and limitations on the maximum number of solar modules in parallel.
- Maximum series fuse rating is refer to “Product Specifications; page 11”.
- Parallel configuration is not limited if proper measures are taken to block the reverse current flow, e.g. fuses for the protection of the module and cables from over-current for prevention of unbalanced string voltage.
- A multiplying factor is required for increased output of the PV modules. Under normal conditions, a PV module is likely to experience conditions that produce more current and/or voltage than reported at standard test conditions. The requirements of the National Electrical Code (NEC) in Article 690 shall be followed to address these increased outputs. In installations not under the requirements of the NEC, the values of  $I_{sc}$  and  $V_{oc}$  marked on this PV module should be multiplied by a factor of 125% when determining component voltage ratings, conductor ampacities, fuse sizes, and size of controls to the PV output.
- Depending on national directives, additional safety factors might be applicable for over current protection.

## General Wiring

- LG Electronics recommends that all wiring be double insulated with a minimum rating of 90°C (194°F).
- All wiring should use a flexible copper (Cu) conductor.
- The minimum size should be determined by the applicable codes.
- LG Electronics recommends a size no smaller than 12AWG.

## Earth Grounding

- All work must be conducted in conformance with all Federal, State, and local codes and standards.
- Grounding works should be performed by an authorized installer for the safety and maintenance of the system in accordance with all national, state and local electrical codes and regulations and standards.
- Specific information on the solar module dimensions and location of grounding holes is provided in “Product Specifications”.
- One M4 stainless steel bolt, one nut, one spring washer, two flat washers, one cup washer, one star washer and 12 AWG Cu wires are recommended per mounting hole.
- Where common grounding hardware (nut, bolts, washers) is used to attach a listed grounding device, the attachment must be made in conformance with the grounding device manufacturer’s instructions.
- All hardware should be consist of corrosion resistant material such as stainless steel.
- There is an earth hole on the edge of the module frame. Using this hole, an earth conductor and the solar module frame may be recommended to be connected and earthed as the below drawing.
- All screws and nuts shall be tightened to a torque of 4~5 N·m.
- A module with exposed conductive parts is considered to be in compliance with UL 1703 only when is electrically grounded in accordance with the instructions presented below and the requirements of the National Electrical Code.

The installation instructions shall include:

1. Details for wiring shall comply the NEC Article 690.
2. Details for the grounding method of the frame of arrays shall comply with the NEC Article 250.
3. CNL model instruction manuals shall also include a statement that installation shall be in accordance with CSA C22.1, Safety Standard for Electrical Installations, Canadian Electrical Code, Part 1.

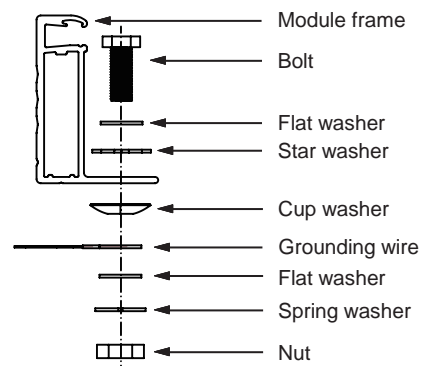

# MECHANICAL INSTALLATION

## Module Mounting

- The LG Electronics' (LGE) Limited Warranty for solar modules is contingent upon modules being mounted in accordance with the requirements described in this section.
- Any module without a frame (laminated) shall not be considered to comply with the requirements of UL 1703 unless the module with hardware that has been tested and evaluated with the module under this standard or by a field inspection certifying that the installed module complies with the requirements of UL 1703.
- We recommend to use mounting device (bolt, nut, washer) made by corrosion resistant material like stainless steel.

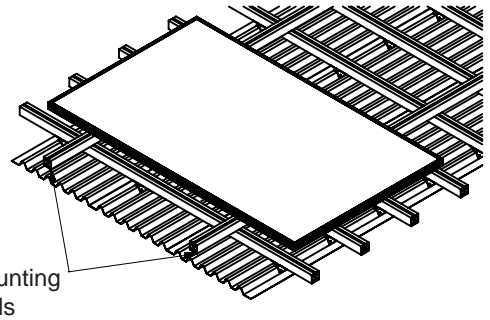

- Use corrosion resistant material mounting rails and hardware.
- Use appropriate bolted connections as per manufacturer's instructions.
- No electrical parts like cables are located after installation between laminate and mounting structure.

## Site Consideration

LGE solar modules should be mounted in a location that meets the following requirements.

### Operating Temperature

- Maximum Operating Temperature: +90°C (194°F)
- Minimum Operating Temperature: -40°C (-40°F)

### Excluded Operating Environments

- The solar modules from LG Electronics can not be operated in a location where they could come in direct contact with salt water or ammonia.

### Design Strength(Basic Load)

- 60Cell Modules : 75lb/ft<sup>2</sup>
- 72Cell Modules : 60lb/ft<sup>2</sup>
- Detail of mounting distance is below.

	60Cell	① : 200mm(7.9in) ② : 300mm (11.8in)
	72Cell	① : 300mm(11.8in)

- ※ This mounting method is by using frame bolt holes.
- ※ The mounting rails must run perpendicularly to the module long side.

### Shadow

- LGE solar module should be installed in a proper site that there is no shadowing affected by building, chimney, tree, and neighboring module, etc.

## Mounting Methods

### General Information

- Select the appropriate orientation to maximize sunlight exposure.
- Module should not be mounted or stored in a way that the front/top glass faces downward in order to prevent water from entering the junction box, which could cause a safety hazard.
- Clearance between the solar module frames and structures such as roofs or ground is required to prevent wiring damage and to allow air to circulate behind the solar module. The recommended standoff height is a minimum of 100mm.
- When installed on a roof, the solar module must be mounted over a fire-resistant roof covering rated for the application.
- A slope less than 5in/ft is required to maintain a fire class rating.
- The solar module is only UL listed for use when its factory frame is fully intact.
- Removal or alteration must be done by an authorized and qualified individual.
- Creating additional mounting holes may damage the solar module and reduce the strength of the frame.
- We recommend a 6mm gap between module frames to avoid tension from thermal expansion.



- The fire rating of this module is valid only when mounted in the manner specified in the mechanical mounting instructions.
- The module is considered to be in compliance with UL1703 only when the module is mounted in the manner specified by the mounting instructions below.
- The solar module may be mounted by using the following methods: (\*Torque:8~12N·m)
- LG modules (Fire performance : Type 1 or 2) shall be mounted with racking and mounting products certified and listed for system fire class rating in accordance with UL1703 edition 2014 and UL2703 edition 2014.
- It is recommended to check with local authorities for fire safety guidelines and requirements for any building or structure on to which the panels will be installed.
- When installing modules in heavy snow areas, it is recommended to be taken an appropriate countermeasure to prevent possible damages to the lower side frame by slipping snow.  
We recommend to use corrosion resistant material according to standard UL 1703 or UL2703 for these supporting part. (A snow guard should be installed in accordance with the manufacturer's instructions.)

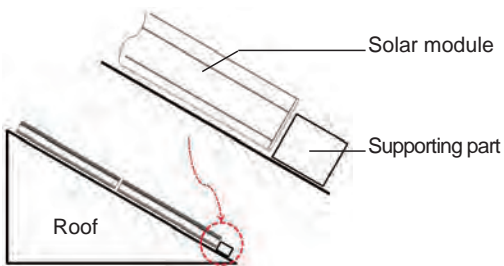

### Mounting by using frame bolts holes

- Secure the solar module to the structure by using the factory mounting holes.
- Four M8(5/16inch) stainless steel bolts, four nuts, four spring washers, and eight flat washers are recommended per solar module.
- The module may be fastened to a support by using both the outer and inner bolt holes of the frame.
- Each module should be securely fastened at a minimum 4 points on two opposite sides.

- Specific information on the solar module dimensions and location of mounting holes is provided in 'Product Specifications'.
- Tighten the bolt securely by using the combination. Place the spring washer between the Flat washer and Nut.

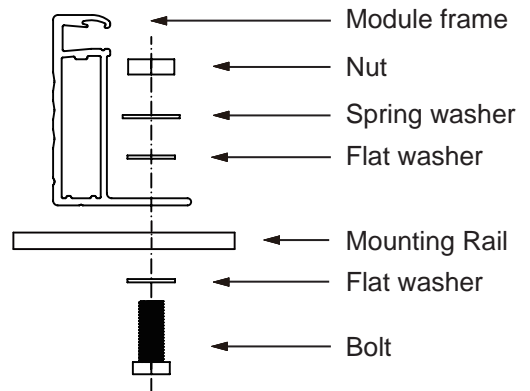

\* Mounting Rails Material : Aluminum, Stainless steel, etc.  
→ We recommend more than 40x40mm mounting rails.

### Mounting by using clamps

- The module may be fastened to a support by using clamps on both the long edge and the short edge of the modules.
- Specific information on location of clamping is provided in 'Mechanical Installation Scene'. (Refer to Appendix.)  
→ If you use a special clamp, it needs to test for compatibility by LGE.
- If the installation is likely to be affected by heavy(extreme) snow, further suitable panel support is recommended on the lower row of panels.

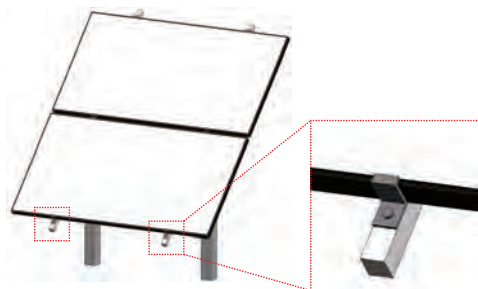

# DISCLAIMER OF LIABILITY / DISPOSAL

## Disclaimer of Liability

- By beginning to installation process, the installer has to read and completely understand this Installation Manual.
- If installer had any questions regarding this installation manual, the installer would have contacted LG with any questions or concerns.
- By installing an LG Solar module, I discharge, and covenant not to sue LG, its affiliated companies, successors, or assigns, its administrators, directors, agents, officers, volunteer and employees, other participants in any activity connected to installation, operation, or service of LG Solar Modules, and if applicable, from all liabilities, claims, demands, losses, or damages on my account caused or alleged to be caused in whole or in part by the negligence of the LG its affiliated companies, successors, or assigns, its administrators, directors, agents, officers, volunteer and employees.

## Disposal

- Please contact us, if you have any queries related to the disposal or recycling of solar modules from LG Electronics.

# TRANSPORTING AND STORAGE

- Do not loosen the banding, when the module is transported by truck, ship and etc.  
In case of loose banding, the module will be shaken, which may cause damage.
- Do not stack on more than one pallet. Maximum height is two pallets. Severe stacking can cause stress to the module and may cause product damage.
- Do not transport only one side of the module when transporting the module. Damage to the frame or cable may occur.

# REVISIONS TABLE

Date	Version	Description of change	Remark
2018.06.04	1.0 (1 <sup>st</sup> edition)	Publish Installation Manual	



# PRODUCT SPECIFICATIONS

## N-TYPE

Rated electrical characteristic except power rating within -0/+3 percent are within 5 percent of measured.  
 Values at Standard Test Condition(STC) : Irradiance 1000W/m<sup>2</sup>, Cell temp. 25°C, 1.5AM

Module Series	Model Name	Electrical Properties								Mechanical Properties				
		P <sub>max</sub> at STC	Power Tolerance	V <sub>oc</sub> at STC	I <sub>sc</sub> at STC	V <sub>mpp</sub> at STC	I <sub>mpp</sub> at STC	Max. Series Fuse Rating	Max. System Voltage	Connector	Length	Width	Height	Weight
		W	%	V	A	V	A	A	V		mm	mm	mm	kg
LGXXXN1C(W,K)-V5	LG325N1C(W)-V5	325	0~3%	40.8	10.41	33.3	9.77	20	1000	MC4/05-8-cm	1686	1016	40	17.1
	LG330N1C(W)-V5	330	0~3%	40.9	10.45	33.7	9.80	20	1000	MC4/05-8-cm	1686	1016	40	17.1
	LG335N1C(W)-V5	335	0~3%	41.0	10.49	34.1	9.83	20	1000	MC4/05-8-cm	1686	1016	40	17.1
	LG340N1C(W)-V5	340	0~3%	41.1	10.53	34.5	9.86	20	1000	MC4/05-8-cm	1686	1016	40	17.1
	LG345N1C(W)-V5	345	0~3%	41.2	10.57	34.9	9.89	20	1000	MC4/05-8-cm	1686	1016	40	17.1
	LG315N1K-V5	315	0~3%	40.7	10.15	32.9	9.58	20	1000	MC4/05-8-cm	1686	1016	40	17.1
	LG320N1K-V5	320	0~3%	40.8	10.19	33.3	9.62	20	1000	MC4/05-8-cm	1686	1016	40	17.1
	LG325N1K-V5	325	0~3%	40.9	10.23	33.7	9.65	20	1000	MC4/05-8-cm	1686	1016	40	17.1
	LG330N1K-V5	330	0~3%	41.0	10.27	34.1	9.69	20	1000	MC4/05-8-cm	1686	1016	40	17.1
	LG335N1K-V5	335	0~3%	41.1	10.31	34.5	9.72	20	1000	MC4/05-8-cm	1686	1016	40	17.1
LGXXXN2W-V5	LG390N2W-V5	390	0~3%	49.1	10.39	39.8	9.81	20	1500	MC4/05-8-cm	2024	1024	40	20.3
	LG395N2W-V5	395	0~3%	49.2	10.43	40.2	9.83	20	1500	MC4/05-8-cm	2024	1024	40	20.3
	LG400N2W-V5	400	0~3%	49.3	10.47	40.6	9.86	20	1500	MC4/05-8-cm	2024	1024	40	20.3
	LG405N2W-V5	405	0~3%	49.4	10.51	41.0	9.89	20	1500	MC4/05-8-cm	2024	1024	40	20.3

Note) MC4 formal name : PV-KST4 / 6II-UR, PV-KBT4 / 6II-UR

→ Plus (+) Connector : Female MC4 coupler (PV-KBT4/6II-UR)

→ Negative (-) Connector : Male MC4 coupler (PV-KST4/6II-UR)

A safety locking clip (MC PV-SSH4) may be required per article 690 of NEC 2008

### ◇ Male and female cable couplers ◇

Male cable coupler ⊖



Female cable coupler ⊕

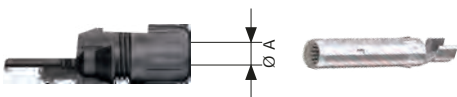

Model	Cable Cross Section	Ø A (Cable outer diameter)	Rated current
MC4	4mm <sup>2</sup>	5.5 ~ 9mm	30A
	12AWG		
05-8-cm	4mm <sup>2</sup>	5.4 ~ 7.2mm	20A
	12AWG		

※ See more information >> <http://www.multi-contact.com/> or <http://www.renhesolar.com/>

# Dimensions of Modules

Unit: mm / in.

## 60Cell Module

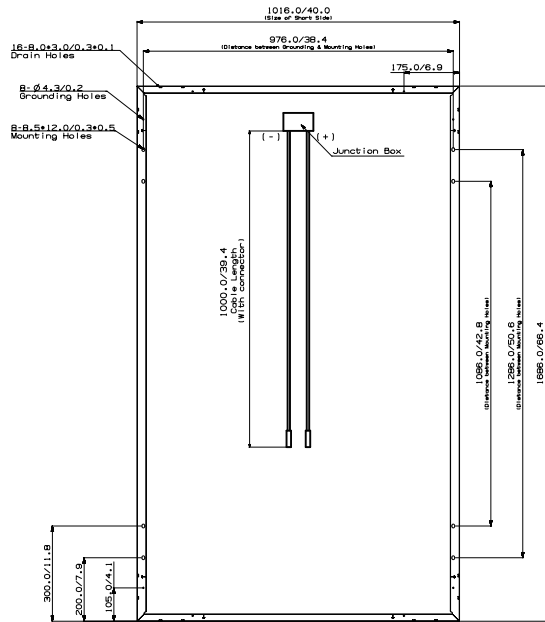

## 72Cell Module

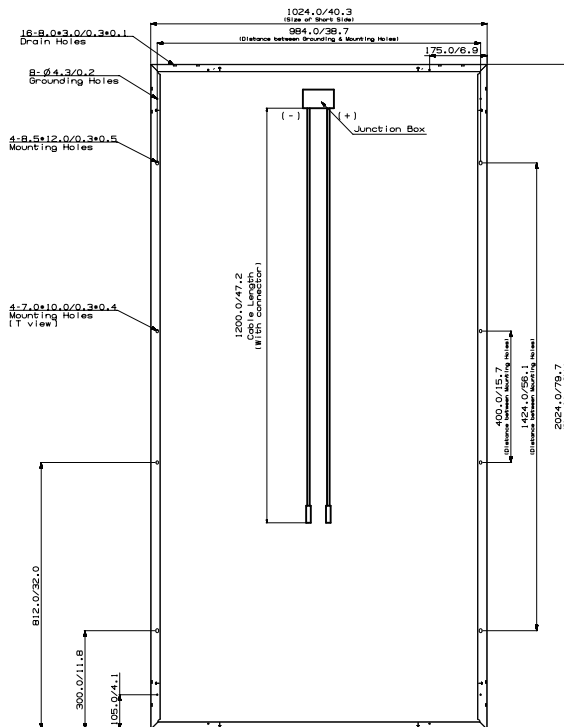

# APPENDIX

## Mechanical Installation : 60Cell Model

Fig.1 Bolting Type		Fig.2 Clamping Type	
① : 200mm(7.9 in) ② : 300mm(11.8 in)	Front : 5400Pa(113psf) Rear : 4000Pa(84psf)	A : 200mm(7.9 in) B : 400mm(15.7 in)	Front : 5400Pa(113psf) Rear : 4000Pa(84psf)
Fig.3 Clamping Type		Fig.4 Clamping Type	
A : 200mm(7.9 in) B : 400mm(15.7 in)	Front : 4000Pa(84psf) Rear : 4000Pa(84psf)	A : 120mm(4.7 in)	Front : 1800Pa(38psf) Rear : 1800Pa(38psf)
		B : 200mm(7.9 in)	Front : 2400Pa(50psf) Rear : 2400Pa(50psf)
Fig.5 Clamping Type		Fig.6 Clamping Type	
A : 200mm(7.9 in) B : 400mm(15.7 in)	Front : 5400Pa(113psf) Rear : 4000Pa(84psf)	A : 120mm (4.7 in)	*4point(①)
C : 120mm(4.7 in)	Front : 5400Pa(113psf) Rear : 1800Pa(38psf)	A : 120mm B : 843 ±100mm (33.2±3.9 in)	6point(①+②)

Note) All mechanical installation methods(Fig.1 to Fig.6) in this appendix were not tested by UL.  
(UL 1703, ULC 1703) It is evaluated by LG internal test.

# Mechanical Installation : 72Cell Model

Fig.1 Bolting Type		Fig.2 Clamping Type		
① : 300mm(11.8 in)	Front : 5400Pa(113psf) Rear : 3000Pa(63psf)	A : 250mm(9.8 in) B : 400mm(15.7 in)	Front : 5400Pa(113psf) Rear : 3000Pa(63psf)	
Fig.3 Clamping Type		Fig.4 Clamping Type		
A : 250mm(9.8 in) B : 400mm(15.7 in)	Front : 3000Pa(63psf) Rear : 3000Pa(63psf)	A : 120mm(4.7 in) B : 250mm(9.8 in)	Front : 1600Pa(33psf) Rear : 1600Pa(33psf)	
Fig.5 Clamping Type		Fig.6 Clamping Type		
A : 250mm(9.8 in) B : 400mm(15.7 in)	Front : 5400Pa(113psf) Rear : 3000Pa(63psf)	A : 120mm (4.7 in)	*4point(①)	Front : 1600Pa(33psf) Rear : 1600Pa(33psf)
C : 120mm(4.7in)	Front : 3600Pa(75psf) Rear : 1600Pa(33psf)	A : 120mm B : 1012±100mm (39.8±3.9 in)	6point(①+②)	Front : 5400Pa(113psf) Rear : 3000Pa(63psf)

Note) All mechanical installation methods(Fig.1 to Fig.7) and bolting method in this appendix were not tested by UL. (UL 1703, ULC 1703) It is evaluated by LG internal test.

**Fig7. Bolting Type**

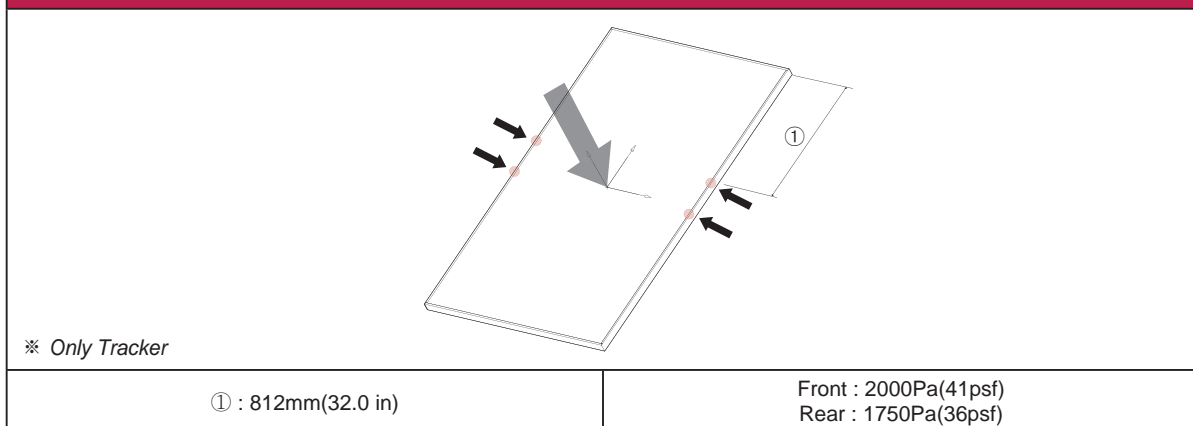

Note) When installed Fig.7, follow the tracker manufacturer's recommended applied torque and materials to fasten the modules.

## Bolting Method

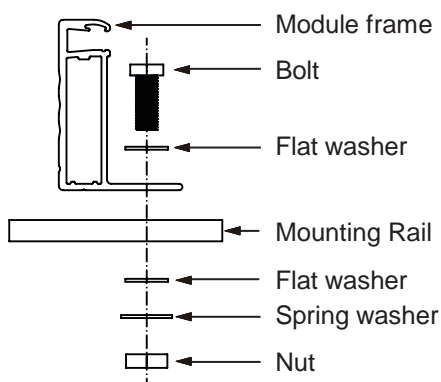

- Four M8(5/16inch) stainless steel bolts, four nuts, four spring washers, and eight flat washers are recommended per solar module.

## Clamp system requirements

- The clamp should not be touched with the module's glass.
- Use corrosion resistant material clamps and hardware.  
→ If you use a special clamp, it needs to test for compatibility by LGE.
- Use appropriate bolted connections as per clamp manufacturer's instructions.
- Follow the clamp manufacturer's recommended applied torque to fasten the clamps.

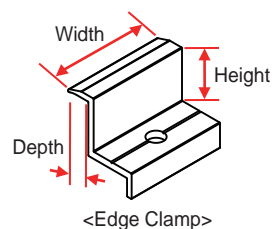
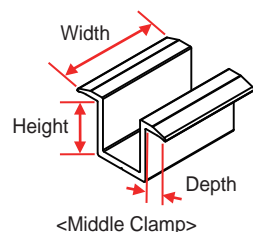

Note) All mechanical installation methods(Fig.1 to Fig.7) and bolting method in this appendix were not tested by UL. (UL 1703, ULC 1703) It is evaluated by LG internal test.

## Alternate Equipment Grounding Devices

This appendix defines alternative grounding methods for LG PV modules and applies to the LG Module Install manual and listed manufacture's installation guide. These alternative grounding devices indicated on this page has been evaluated and approved by LG, not by Intertek. If such devices want to be used to meet the requirement in UL1703, some adequate tests shall be conducted in accordance with UL1703 additionally.

### Line of Devices

Products		Remark
Manufacture	Ground Devices	
Everest	- Everest Solar Universal Bonding Clamp	
IronRidge	- IronRidge IG (Integrated Grounding) Clamp / UFO Mid Clamp	
Unirac	- Unirac Bonding Mid Clamp / SunFrame Micro Rail / Wire Bonding Clip w/ 8 AWG	
Panel Claw	- Standard Claw / Long Claw / PolaBear III Claw	
Quickmount PV	- Quick Rack Panel Clamp	
SnapNrack	- SnapNrack Bonding Mid Clamp / SnapLink for RL system	
Ecolibrium	- EcoX Clamp and Coupling assembly / EcoFoot Clamp	
Pegasus	- Pegasus LightSpeed Corners	
Schletter	- Rapid Grounding Module Clamps	
Dynorax	- DynoBond	
Roof Tech	- Roof Tech Bonding Plate	
ILSCO	- ILSCO SGB-4 Solar Grounding Lug	
TYCO	- TYCO 2058729 / 2106831 SolarLock Grounding Assy	
Wiley Burndy	WEEB LUG / WEEB KMC in combination with Everest clamp / WEEB DMC in combination with IronRidge clamp / Wiley WEEB UMC or UGC-1 in combination with Unirac clamp / WEEB PMC in combination with Pro Solar clamp / WEEB DPW in combination with DPW Solar clamp	

### Important Notes

1. The NEC section 690.43 states, "Exposed non-current carrying metal parts of module frame, equipment and conductor enclosures shall be grounded in accordance with 250.134 or 250.136(A) regardless of voltage"
2. Functionality will not be guaranteed if reused.

# Unloading Flow Guide

If you are unloading using heavy equipment such as a crane, please follow the procedure below.

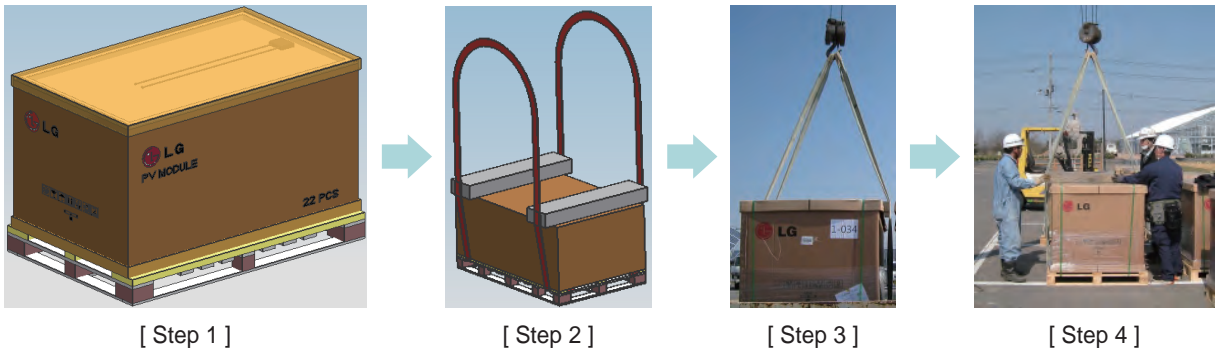

Step 1. Place the packaging on a flat surface.

Step 2. Put the safety timber bar on the packaging and fasten a rope as shown Fig. [ Step 2 ]

- To prevent module breakage, you should use safety timber bar bigger than packaging length.
- The position of rope have to be between block 1 and block 2 when you fasten a rope to pallet.
- Detailed view of the rope position is below.

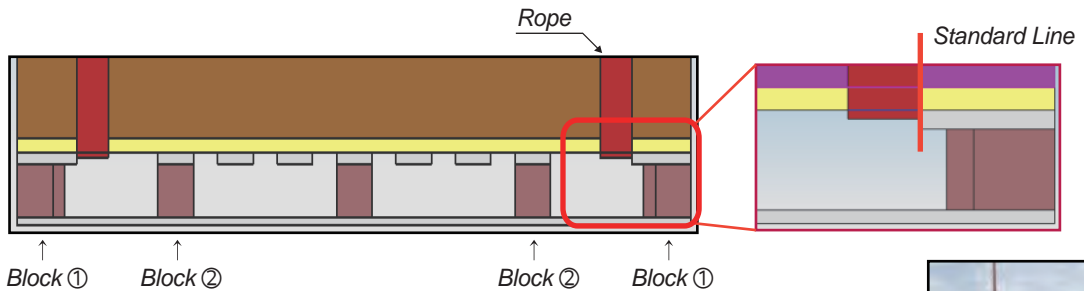

- If you have not timber bar, you can use a pallet which is longer than module size.

Step 3. Loading & unloading packaging.

- The crane hook have to be placed center of packaging.
- For the balance of packaging, the rope between the packaging and crane must be the same length.



Step 4. Landing packaging on a floor.

- A minimum of two operator is required to ensure that all four corners are seated at the same



► If you need some question or advice of this, please contact our sales manager.



LG Electronics U.S.A Inc.  
2000 Millbrook Dr., Lincolnshire, IL 60069  
Contact : [lg.solar@lge.com](mailto:lg.solar@lge.com)  
<http://www.lgsolarusa.com>

This document is subject to change without notice.

LG, LG logo and Life's Good are trademarks of LG Electronics, Inc. worldwide. Trademarks and intellectual properties of LG Electronics, Inc. are protected by international copyright laws.



# Enphase IQ Combiner 3

(X-IQ-AM1-240-3)

The **Enphase IQ Combiner 3™** with Enphase IQ Envoy™ consolidates interconnection equipment into a single enclosure and streamlines PV and storage installations by providing a consistent, pre-wired solution for residential applications. It offers up to four 2-pole input circuits and Eaton BR series busbar assembly.

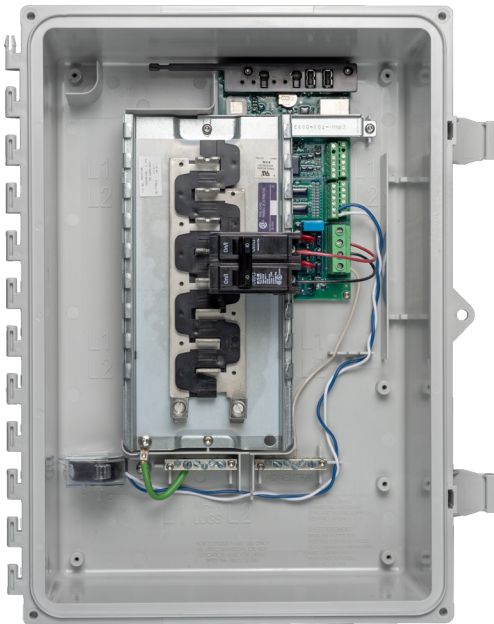

## Smart

- Includes IQ Envoy for communication and control
- Flexible networking supports Wi-Fi, Ethernet, or cellular
- Optional AC receptacle available for PLC bridge
- Provides production metering and optional consumption monitoring

## Simple

- Reduced size from previous combiner
- Centered mounting brackets support single stud mounting
- Supports back and side conduit entry
- Up to four 2-pole branch circuits for 240 VAC plug-in breakers (not included)
- 80 A total PV or storage branch circuits

## Reliable

- Durable NRTL-certified NEMA type 3R enclosure
- Five-year warranty
- UL listed



**LISTED**

To learn more about Enphase offerings, visit [enphase.com](https://enphase.com)

# Enphase IQ Combiner 3

## MODEL NUMBER

IQ Combiner 3 X-IQ-AM1-240-3	IQ Combiner 3 with Enphase IQ Envoy™ printed circuit board for integrated revenue grade PV production metering (ANSI C12.20 +/- 0.5%) and optional* consumption monitoring (+/- 2.5%).
------------------------------	--

## ACCESSORIES and REPLACEMENT PARTS (not included, order separately)

Enphase Mobile Connect™ CELLMODEM-03 (4G / 12-year data plan) CELLMODEM-01 (3G / 5-year data plan) CELLMODEM-M1 (4G based LTE-M / 5-year data plan)	Plug and play industrial grade cellular modem with data plan for systems up to 60 microinverters. (Available in the US, Canada, Mexico, Puerto Rico, and the US Virgin Islands, where there is adequate cellular service in the installation area.)
--	---

Consumption Monitoring* CT CT-200-SPLIT	Split core current transformers enable whole home consumption metering (+/- 2.5%).
--	--

Circuit Breakers BRK-10A-2-240 BRK-15A-2-240 BRK-20A-2P-240	Supports Eaton BR210, BR215, BR220, BR230, BR240, BR250, and BR260 circuit breakers. Circuit breaker, 2 pole, 10A, Eaton BR210 Circuit breaker, 2 pole, 15A, Eaton BR215 Circuit breaker, 2 pole, 20A, Eaton BR220
--	---

EPLC-01	Power line carrier (communication bridge pair), quantity 2
---------	--

XA-PLUG-120-3	Accessory receptacle for Power Line Carrier in IQ Combiner 3 (required for EPLC-01)
---------------	---

XA-ENV-PCBA-3	Replacement IQ Envoy printed circuit board (PCB) for Combiner 3
---------------	---

## ELECTRICAL SPECIFICATIONS

Rating	Continuous duty
System voltage	120/240 VAC, 60 Hz
Eaton BR series busbar rating	125 A
Max. continuous current rating (output to grid)	65 A
Max. fuse/circuit rating (output)	90 A
Branch circuits (solar and/or storage)	Up to four 2-pole Eaton BR series Distributed Generation (DG) breakers only (not included)
Max. continuous current rating (input from PV)	64 A
Max. total branch circuit breaker rating (input)	80A of distributed generation / 90A with IQ Envoy breaker included
Production Metering CT	200 A solid core pre-installed and wired to IQ Envoy

## MECHANICAL DATA

Dimensions (WxHxD)	49.5 x 37.5 x 16.8 cm (19.5" x 14.75" x 6.63"). Height is 21.06" (53.5 cm with mounting brackets).
Weight	7.5 kg (16.5 lbs)
Ambient temperature range	-40° C to +46° C (-40° to 115° F)
Cooling	Natural convection, plus heat shield
Enclosure environmental rating	Outdoor, NRTL-certified, NEMA type 3R, polycarbonate construction
Wire sizes	<ul style="list-style-type: none"><li>• 20 A to 50 A breaker inputs: 14 to 4 AWG copper conductors</li><li>• 60 A breaker branch input: 4 to 1/0 AWG copper conductors</li><li>• Main lug combined output: 10 to 2/0 AWG copper conductors</li><li>• Neutral and ground: 14 to 1/0 copper conductors</li></ul> Always follow local code requirements for conductor sizing.
Altitude	To 2000 meters (6,560 feet)

## INTERNET CONNECTION OPTIONS

Integrated Wi-Fi	802.11b/g/n
Ethernet	Optional, 802.3, Cat5E (or Cat 6) UTP Ethernet cable (not included)
Cellular	Optional, CELLMODEM-01 (3G) or CELLMODEM-03 (4G) or CELLMODEM-M1 (4G based LTE-M) (not included)

## COMPLIANCE

Compliance, Combiner	UL 1741 CAN/CSA C22.2 No. 107.1 47 CFR, Part 15, Class B, ICES 003 Production metering: ANSI C12.20 accuracy class 0.5 (PV production)
Compliance, IQ Envoy	UL 60601-1/CANCSA 22.2 No. 61010-1

\* Consumption monitoring is required for Enphase Storage Systems.

To learn more about Enphase offerings, visit [enphase.com](http://enphase.com)

© 2018 Enphase Energy. All rights reserved. All trademarks or brands in this document are registered by their respective owner.  
2018-09-13



# Installing the Enphase IQ Combiner 3

The Enphase IQ Combiner 3™ combines up to four AC branch circuits of Enphase IQ Series Microinverters and/or Enphase IQ Batteries. To install the IQ Combiner 3, read and follow all warnings and instructions in this guide. Safety warnings are listed on the back of this guide. If you do not fully understand any of the concepts, terminology, or hazards outlined in these instructions, refer installation to a qualified electrician or installer. These instructions are not meant to be a complete explanation of a renewable energy system. All installations must comply with national and local electrical codes. Professional installation is recommended.

The IQ Combiner 3 is an outdoor-rated, NRTL-certified NEMA type 3R enclosure containing an Enphase IQ Envoy™, circuit breakers, and wiring for IQ Envoy connections. Use the IQ Combiner 3 for single-phase applications and to support the AC connections needed for an Enphase residential solar installation.

**IMPORTANT: Enphase IQ Series Microinverters require the Q Cable and are not compatible with previous Enphase cabling. The IQ Envoy inside the Combiner is required to monitor performance of the IQ Microinverters. The Q Accessories work only with Enphase IQ Series Microinverters.**

## How It Works

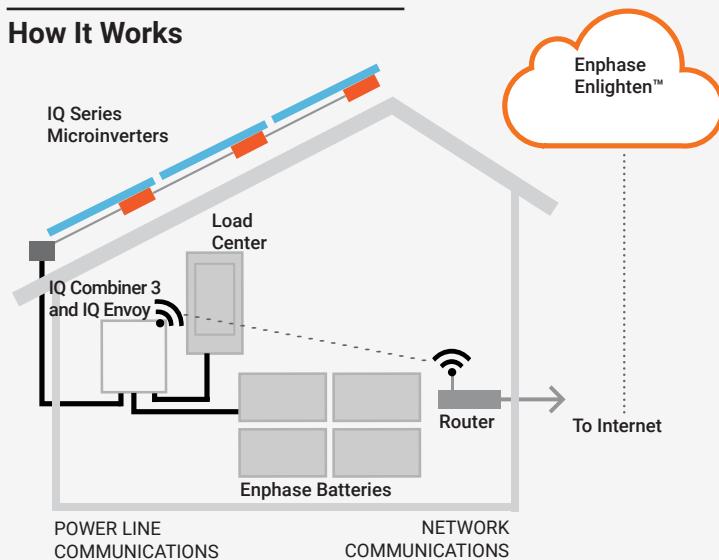











## PREPARATION



- Download the Enphase Installer Toolkit mobile app and open it to log in to your Enlighten account. With this app, you can connect to the IQ Envoy to track system installation progress. To download, go to [enphase.com/toolkit](http://enphase.com/toolkit) or scan the QR code at right.
- Check the box for the following items:
  - Enphase IQ Combiner 3 with IQ Envoy printed circuit board
  - Enphase IQ Combiner 3 Quick Install Guide** (this document)
- Make sure you have the following **required** items:
  - Tools: screwdriver, pliers, and torque wrench.
  - Up to four Eaton BR-style breakers (one for each DG branch circuit). You can install 10A, 15A, or 20A breaker(s) in the IQ Combiner 3 (order BRK-10A-2-240V, BRK-15A-2-240V, and/or BRK-20A-2P-240V).
  - Overcurrent protection in the load center in accordance with NFPA 70, §705.12.
  - Suitable mounting hardware: use #8 (or larger) screws that are long enough to secure the unit to the vertical mounting surface
  - Copper conductors rated for wet locations and sized to meet local code requirements and voltage drop/rise considerations. Wire sizes and torque values are listed on the door of the unit.
  - UL Listed rain-tight hubs for wire entry into the enclosure.
- If you plan to do consumption metering:
  - Make sure you have two split-core consumption metering CTs (order CT-200-SPLIT).
  - Check that there is enough space in the load center to install CTs. Do not install the CTs in a panel where they exceed 75% of the wiring space of any cross-sectional area within the load center.
- Decide how to connect the IQ Envoy to the Internet: Use Wi-Fi, an Enphase Mobile Connect modem, or Ethernet. Then, make sure you have the following optional items, if needed:
  - Enphase Mobile Connect modem
  - Ethernet over power line communication (PLC) bridge with Ethernet cables (order EPLC-01). If you choose this option, you will need to install an Enphase accessory receptacle (order XA-PLUG-120-3) inside the Combiner.
  - Ethernet cable: 802.3, Cat5E or Cat6, unshielded twisted pair (UTP). Do not use shielded twisted pair (STP) cable. You must install a ferrite bead (we recommend Fair-Rite 0431167281) as close as possible to the IQ Envoy on the Ethernet cable.
- Create a paper installation map to record device serial numbers and positions in the array. You will scan this map later using Installer Toolkit and your mobile device.
  - Write the IQ Envoy serial number on the paper installation map. Later, you will need to enter this number in Installer Toolkit. You can type it in manually or scan the label on the inside of the Combiner door.
  - Always keep a copy of the installation map for your records.
- Note that installation of the Combiner has two parts. To ensure successful device detection, complete Part 2 after installing any Enphase IQ Microinverters and/or Enphase AC Battery(ies).**

## IQ Envoy Display and Controls

Track system installation progress with the **Enphase Installer Toolkit** mobile app. The LEDs on the IQ Envoy PCB (printed circuit board) are solid green when a function is enabled or performing as expected, flashing when an operation is in progress, or solid amber when troubleshooting with Installer Toolkit is required. For a legend of all LED states, see [Troubleshooting](#) **a**.

-   — **Network Communications LED**  
Green when IQ Envoy is connected to Enlighten.
-   — **AP Mode LED**  
Green when IQ Envoy's AP Wi-Fi network is available.
-  — **AP Mode Button**  
Press to enable IQ Envoy's AP Mode for connecting with a mobile device. Hold for 5 seconds to start WPS connection to a router.
-   — **Power Production LED**  
Green when microinverters are producing power.
-   — **Device Communications LED**  
Green when devices are communicating with IQ Envoy.
-  — **Device Scan Button**  
Press to start/stop 15 minute scan for devices over the power line.

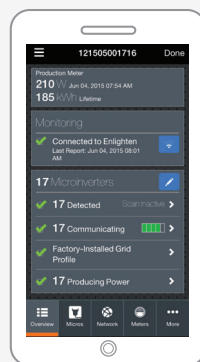

Enphase Installer Toolkit mobile app

**Note:** If needed, you can find an installation map at the back of any Enphase Microinverter Quick Install Guide.

## INSTALLATION – Part 1

It is a best practice to complete Installation Part 1 before installing Enphase Microinverters and/or Batteries.

### 1 Choose a location for the IQ Combiner 3

- A) Install the IQ Combiner 3 in a readily accessible location, at least three feet (91 cm) off the ground if outdoors. Install it at least 12 inches (30.5 cm) off the ground if installed indoors.
- B) Consider the dimensions of the IQ Combiner 3, easy access, box height, and length of cable when selecting the location. The IQ Combiner 3 is rainproof but not watertight.
- C) Mount the IQ Combiner 3 on a vertical surface.

**NOTE:** You must mount the Combiner within 15 degrees of vertical.

### 2 Install Circuit Breaker(s)

The combiner includes one two-pole 10A circuit breaker that feeds the IQ Envoy and the AC outlet (if present). You can install additional breakers, if needed. You must follow all NEC and local electrical codes.

- A) Open the enclosure door. Pinch the top of the hinge rod using a pair of needle-nosed pliers. Slide the door up and away to remove it. Set the door aside for later reattachment.

**NOTE:** Risk of equipment damage. Do not remove the pre-installed heat shield attached to the enclosure door.

- B) Remove the plastic deadfront. It is not necessary to completely remove the screws.



**Warning!** Risk of electric shock. To maintain the warranty, do not modify the dead-front other than to remove or replace filler plates, as needed.

- C) Remove a filler plate on the deadfront for each breaker position you will use. To remove the filler plate, press the single latch inward while gently pushing the filler plate out.
- D) Snap the breaker onto the busbar, using only the breaker positions indicated in the diagram on the door of the unit.

### 3 Drill Holes to Accept Conduit



**Warning!** Risk of equipment damage. Do not drill conduit holes on the top of the box or at any location that allows moisture ingress.

- A) The bottom and sides of the Combiner 3 are the best locations to drill holes for conduit fittings. Rear conduit entry below the busbar assembly is also supported.

**Note:** When drilling, consider the internal parts of the combiner. Make sure that the holes do not interfere with the internal workings, mechanics, or the deadfront legs in the corners of the Combiner.

**Best Practice:** Use a stepped drill bit for making the conduit holes. Using a hole saw may crack the plastic housing. As an alternative, use a sharp chassis punch with caution.

- B) Use a snap punch or other type of center punch to prevent the drill from wandering. Drill a pilot hole with a smaller drill before using a step drill bit.
- C) Use only UL-listed rain-tight hubs for wire entry into the enclosure.



**Warning!** Risk of equipment damage. Observe bend radius requirements when routing wires.

### 4 Wire the Output Connections

Refer to the diagram on the door of the IQ Combiner 3 and do the following:

- A) Use conductors sized per local code requirements taking into consideration the voltage drop/rise and upstream breaker or fuse.
- B) The two terminals below the circuit breaker(s) are the output connections. Install L1 into the left terminal and L2 into the right terminal.
- C) Connect the neutral (white) to the neutral busbar.

**Note:** Enphase IQ Series Microinverters use a two-wire system and do not use a Neutral. However, the IQ Envoy in the combiner still requires a Neutral from the load center.

- D) Connect the ground (green or green/yellow) to the Ground busbar.
- E) Torque all connections as indicated by the table below.

### 5 Wire Inputs from the AC Branch Circuits

You can install AC branch circuit breakers up to 80 A total (sum of handle ratings, excluding the 10 A breaker). With individual branch circuits, you will typically use up to four 20 A breakers. Refer to the diagram on the door of the IQ Combiner 3 and do the following:

- A) Use copper conductors sized to meet local code requirements and voltage drop/rise considerations.
- B) Bring in the wires from each AC branch circuit.
- C) Connect the ground (green or green/yellow) to the ground busbar.
- D) Pass the L1 conductors from each PV branch circuit through the production CT in the same direction as the arrow on the side of the CT.
- E) If you use the fourth (Battery/PV) breaker position for PV, you must route the L1 conductor through the production CT.

**Note:** Do not pass conductors from AC Battery branch circuits through the production CT. This will distort production readings.

- F) Connect L1 and L2 (usually one black and one red) from each AC branch circuit (PV and/or battery) to the circuit breaker(s). Observe the L1 and L2 polarity marking at each breaker position.
- G) Torque all connections as indicated by the following table.

CONNECTION	WIRE SIZES	TORQUE
Eaton BR series DG breaker(s)	14-10 AWG 8 AWG 6-4 AWG	2.2 Nm (20 in-lb) 2.8 Nm (25 in-lb) 3.0 Nm (27 in-lb)
60 A circuit breaker only	4-1/0 AWG	5.0 Nm (45 in-lb)
Neutral and ground		
Large screw	14-1/0 AWG	5.0 Nm (45 in-lb)
Small screw	14 - 6 AWG	2.2 Nm (20 in-lb)
Main lug	10-4 AWG 3-2/0 AWG	5.0 Nm (45 in-lb) 5.6 Nm (50 in-lb)
Copper conductors only, rated minimum 75°C. Follow NFPA 70 (NEC) or CSA C22.1 part 1 and all local codes.		
For DG breakers larger than 20 A, use wire insulated for 90°C based on 75°C ampacities.		

## 6 Install CTs for Consumption Metering (optional)

The IQ Envoy printed circuit board inside the IQ Combiner 3 is pre-wired at the terminal blocks for power and production metering connections. One solid-core current transformer (CT) is provided for revenue grade production metering. You can install two optional split-core CTs to provide consumption metering. To do this, you must create a protected route using conduit for the CT wires from the main load center to the IQ Envoy. If you need to extend the wires, refer to the *Enphase IQ Envoy Installation and Operation Manual* at: [enphase.com/support](http://enphase.com/support).

**Note:** Because of variance in load center design and main power feed, there may not always be enough space to install consumption metering CTs.

- Make sure that the main load center wires are de-energized until you have secured the CT wires in the terminal blocks.
- Before running the CT wires through the conduit, use colored tape to mark one of the CTs and the free end of its wires.
- For the marked CT wires, connect the white and blue wires to the white and blue "C1" terminals.
- For the unmarked CT wires, connect the white and blue wires to the white and blue "C2" terminals.
- Tighten all connections to 5 in-lbs.
- Clamp the marked CT on the load center feed wire Line 1 (matching the Envoy's "L1" voltage terminal) **with the CT arrow pointing toward the load (away from the grid)**.
- Clamp the unmarked CT on the load center feed wire Line 2 (matching the Envoy's "L2" voltage terminal) **with the CT arrow pointing toward the load (away from the grid)**.



**DANGER!** Risk of electric shock. Always de-energize the load center before beginning wiring.



**DANGER!** Risk of electrocution! Do not install CTs when current is flowing in the sensed circuit. Always install CT wires in the terminal blocks before energizing the sensed circuit.

**Notes:** It is important to match CT and sense voltage phases. To properly measure power and energy, CT inputs must align with the respective voltage inputs. Be sure to consistently identify and match the two AC lines at two points: the main load center feed and the Envoy. Wire colors (typically black and red) may not always consistently identify Lines 1 and 2. If in doubt, use a multimeter to check.

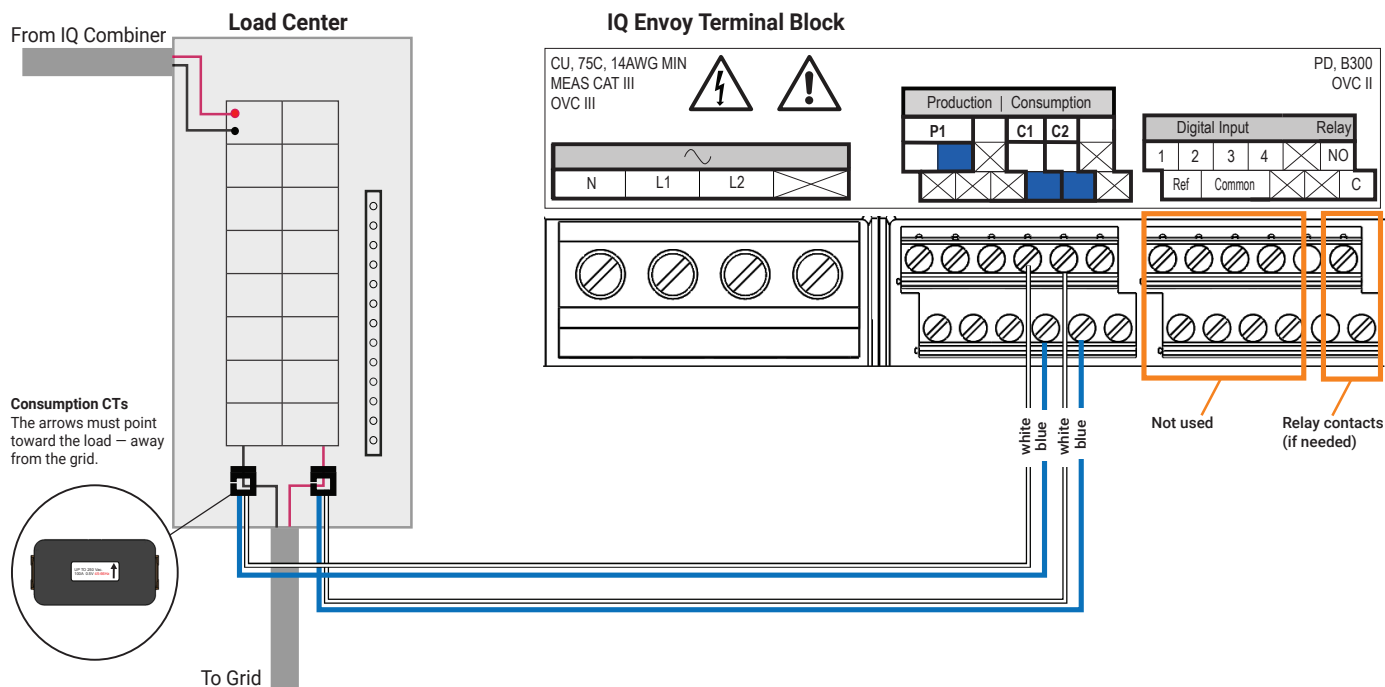

## 7 Energize and Update the IQ Envoy

- Re-install the plastic deadfront. Start all of the screws, but do not completely tighten them.
- Once all screws are partially tightened, go back and tighten each one completely.
- Turn off the DG breaker(s).
- Reinstall the IQ Combiner 3 door.
- Turn on the circuit feeding the combiner.
- On the IQ Envoy (inside the Combiner), if the AP Mode LED is not lit, press the AP Mode button.
- On your mobile device, go to Settings and join the Wi-Fi network "Envoy\_ nnnnnn" (where "nnnnnn" equals the final six digits of the Envoy serial number).
- The app informs you if the software on the Envoy is not the latest version by displaying the Envoy Software Update message. If the app displays this message, follow the on-screen instructions to update the Envoy.
- For a short period (5-10 minutes), you must keep your mobile device near the Combiner. Follow the on-screen instructions while the update takes place.

The update may take up to 20 minutes. The Envoy reboots several times during the update and the LEDs light up in varied sequences until the update is complete.

Once the update is finished and the PV system is installed, the Envoy is ready for Installation Part 2.

All four LEDs flash amber during boot up (approximately 3 minutes). When boot up is complete, the Device Communications LED  lights solid amber, indicating that devices are not yet detected.



## INSTALLATION – Part 2

You must complete Installation Part 2 after installing any Enphase IQ Microinverters and/or Enphase Battery(ies).

### 8 Detect Devices

- Turn on the DG breaker(s).
- Use one of the following methods to detect devices (Enphase IQ Microinverters and/or Enphase Batteries):

#### Method A // Provision devices with Installer Toolkit

Use the Installer Toolkit mobile app to configure the IQ Envoy with the serial numbers of the installed devices.

- Launch the Installer Toolkit app and tap **View Systems**.
- Select the system you are working with, or tap **[+]** to add a system.
- Connect to the IQ Envoy with your mobile device (smart phone or tablet). The AP Mode LED  lights solid green when the network is available.
  - On the Envoy, if the AP Mode LED is not lit, press the **AP Mode** button.
  - On your mobile device, go to Settings and join the Wi-Fi network "Envoy\_nnnnnn" (where "nnnnn" equals the final six digits of the IQ Envoy serial number).
- If the serial number for the Envoy you are installing is not displayed on the System Overview screen, tap the **[+]** next to the word "Envoys". When the app displays the serial number of the Envoy, tap it to add it to the system.
- Following the on-screen instructions to create the arrays and scan the serial numbers from the installation map.
- Tap the **Connect** button. This provisions the scanned devices on the Envoy.
- When prompted, confirm the number of devices that you installed.
- If your system is in Hawaii or in a region that does not use the **Factory-Installed Grid Profile**, select and apply a grid profile to the devices.

The Device Communications LED  lights solid green if all provisioned devices are communicating or solid amber if any devices are not communicating.

#### Method B // Discover devices with Installer Toolkit

Use the Installer Toolkit mobile app to set the number of devices the IQ Envoy should search for on the power line.

- Connect to the IQ Envoy with your mobile device (smart phone or tablet). The AP Mode LED  lights solid green when the network is available.
  - On the Envoy, if the AP Mode LED is not lit, press the AP Mode button.
  - On your mobile device, go to Settings and join the Wi-Fi network "Envoy\_nnnnnn" (where "nnnnn" equals the final six digits of the IQ Envoy serial number).
- Launch Installer Toolkit and tap **Connect to an Envoy**.
- When prompted, enter the number of devices that you installed.
- If your system is in Hawaii or in region that does not use the **Factory-Installed Grid Profile**, select and apply a grid profile to the devices.
- When prompted to start a device scan, tap **OK**.

The Device Communications LED  flashes green while scanning, solid green when all the devices you installed are communicating, or solid amber if any devices are not communicating.

#### With both methods



If the Device Communications LED remains solid amber, see *Troubleshooting* .

### 9 Verify System Configuration

While still connected to the IQ Envoy with Installer Toolkit, check the Overview screen for the following:

- Confirm that the expected number of devices are detected and communicating.
- Check that the new profile is set on all the devices. Setting the profile may take up to 5 minutes for a typical system.
- Tap the **Meters** button.

- Tap **Production Meter** and follow the on-screen instructions to enable the Production Meter.
- If you installed consumption metering CT(s), tap **Consumption Meter** and follow the on-screen instructions to enable the Consumption Meter.
- Return to the **Overview** screen and verify the meter reading(s).

If you used Installer Toolkit to detect devices, the Power Production LED  lights solid green when all **expected** microinverters are producing power. If you did not use Installer Toolkit, it lights solid green if all **communicating** microinverters are producing power. It flashes green when devices are upgrading. Check Installer Toolkit for production status details. If the Power Production LED remains solid amber, see *Troubleshooting* .

### 10 Connect to Enlighten

This step describes using the IQ Envoy integrated Wi-Fi or the Mobile Connect modem to connect to the Internet. For information about using Ethernet and/or PLC bridges, refer to the *Enphase IQ Envoy Installation and Operation Manual* at: [enphase.com/support](http://enphase.com/support).



#### Method A // Integrated Wi-Fi

Requires a wireless router with an Internet connection.

- On the Envoy, verify that no Ethernet cable is plugged into the RJ45 port.
- If the router supports WPS, press and hold the WPS button on the wireless router for a few seconds. On most routers, a WPS indicator begins flashing.

- If you are using the Installer Toolkit mobile app, tap the **Network** button, tap **Wi-Fi**, and then tap your network from the list of available networks. If the wireless router does not support WPS, you may be prompted to enter a password.



The Network Communications LED  begins **flashing** green. Within three minutes the same LED lights **solid** green, indicating a successful connection to Enlighten. If the Network Communications LED remains off or lights solid amber, see *Troubleshooting* .

#### Method B // Enphase Mobile Connect Modem

(Order CELLMODEM-01 or CELLMODEM-03 separately)

- Connect the antenna(s) to the modem, and mount the modem as described in the *Enphase Mobile Connect Installation Guide*.
- First, connect the USB cable to the IQ Envoy and then connect the mini-USB connector to the modem.

If receiving power from the IQ Envoy, the modem power LED lights.

Within three minutes the Network Communications LED  lights solid green, indicating a successful connection to Enlighten. If the Network Communications LED remains off or lights solid amber, see *Troubleshooting* in the *Enphase Mobile Connect Installation Guide*.

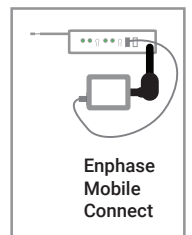

IQ Combiner 3

### 11 Send System Summary Report

When you have completed your system setup, you can generate and email a summary report.

- From Installer Toolkit, tap **Done** in the upper-right corner of the screen to disconnect from the Envoy. Installer Toolkit will ask if you want to view a summary report.
- Tap **View Report**. The report displays IQ Envoy and system information with a list of device serial numbers, their last power reports, and information about the grid profile applied to the microinverters.
- Tap  to email the report to your office as a record of successful system installation or to the utility for evidence of grid profile settings.

## 12 Activate Monitoring

Register the IQ Envoy in Enlighten ([enlighten.enphaseenergy.com](http://enlighten.enphaseenergy.com)).

### Method A // If the IQ Envoy is associated with a system in Installer Toolkit

- On your mobile device, go to Settings and disconnect from the Envoy's AP Wi-Fi network.
- Return to the Installer Toolkit app and tap the **Sync** button on the System Overview screen.
- When you have access to a computer, log in to Enlighten and select the system name from the Activation List on the dashboard.
- From the activation form, open Array Builder.

If you used Installer Toolkit to build arrays and scan device serial numbers, the array(s) are built. Make any necessary adjustments in Array Builder.

If you did NOT use Installer Toolkit to build arrays and scan device serial numbers, create the virtual array in Array Builder using the installation map as your reference.





### Method B // If the IQ Envoy is NOT associated with a system in Installer Toolkit

- Log into Enlighten and click **Add a New System** from the dashboard.
- Enter the System, Installer, Owner, and Location information.
- Enter the IQ Envoy serial number.
- Click **Save** to submit the form.
- After the devices have reported to Enlighten, open Array Builder from the activation form, and create the virtual array, using the installation map as your reference.

## TROUBLESHOOTING

Contact Enphase Customer Support ([enphase.com/en-us/support/contact](http://enphase.com/en-us/support/contact)) if you have any questions about troubleshooting your system.

### a LED overview

LED	State	Description
All	Flashing amber in unison	The IQ Envoy is booting up
	Flashing green sequentially	Software upgrade in progress
 Network communications	Solid green	Communicating with Enlighten
	Flashing green	WPS connection in progress, or IQ Envoy is attempting to connect to Enlighten
	Solid amber	Local network connection only
	Off	No network connection
 AP mode	Solid green	AP mode enabled: IQ Envoy Wi-Fi network available
	Off	AP mode disabled: IQ Envoy Wi-Fi network unavailable
 Power production	Solid green	All communicating microinverters are producing
	Flashing green	Microinverter upgrade in progress
	Solid Amber	At least one microinverter is not producing
	Off	Microinverters are not communicating (low light or night time)
 Device communications	Solid Green	All devices are communicating
	Flashing Green	Device scan in progress
	Solid Amber	At least one device is not communicating
	Off	Devices are not communicating (low light or night time)

### b Device detection issues

If the Device Communications LED  lights solid amber, it may be a result of low light levels. If there isn't enough sunlight to power up the microinverters, they can't communicate with the Envoy.

If there is sufficient daylight for the microinverters to power up, the issue may be that the Envoy is having difficulty communicating over the power lines. To troubleshoot this issue:

- Check the Installer Toolkit mobile app to see which devices are not communicating.
- Check that the circuit breaker(s) in the IQ Combiner 3 for the PV array are in the "ON" position.
- Verify that the PV modules are connected to the microinverters.
- Verify the PV module DC voltage is within the allowable range for the microinverter.

### c Power production issues

If the Power Production LED  lights solid amber, check the Installer Toolkit mobile app to see which microinverters are not producing:

- If none of the microinverters are producing power, there may be a grid or wiring issue. First, verify that there is proper input voltage and frequency from the utility. Next, check the breaker and wiring, starting at the load center.
- If all of the non-productive microinverters are on the same branch, check the breaker and wiring starting at the junction box for the affected branch.
- If only one or scattered microinverters are not producing power, first check to see that the AC connectors are fully seated. Next, check that each module is providing the required startup voltage for the microinverter (22V). A PV module that is failing or that is undersized may not generate enough power for AC conversion.

### d Internet connection issues

If you are using Wi-Fi and the Network Communications LED  remains off or solid amber:

- The WPS connection window may have timed out. Retry the connection steps.
- Make sure that the broadband router is connected and operational by checking that other devices at the site can access the network.
- Be aware that metal enclosures or obstructions impede wireless communication.
- If you don't see your router/access point in the list on the Envoy, or cannot maintain a connection, you may need to add a wireless repeater to extend the network range.

You can troubleshoot network issues with the Installer Toolkit mobile app by tapping the **Network** button, then **Diagnostic Tools**.

If you are using the Enphase Mobile Connect modem and the Network Communications LED remains off or lights solid amber, see Troubleshooting in the *Enphase Mobile Connect Installation Guide*.

If you replace your router, configure the IQ Envoy Wi-Fi settings for the new Wireless Network Name (SSID) and password, or use the WPS function described in Installation Step 10.

### e Loss of AC to a single branch of microinverters

If a single branch of microinverters is not producing, it may indicate loss of AC to the branch.

- Use a multi-meter set to AC to test the breaker lugs. The result should be around 240 VAC.
- If not, switch the breaker off and on to reset.

### f Inoperable IQ Envoy (all LEDs off)

If the IQ Envoy is not receiving power, all LEDs will be off.

- Use a multimeter set to AC to test line 1 on the Envoy breaker to the AC neutral busbar. The result should be around 120 VAC.

### g Inoperable IQ Envoy and no AC to branch

If a branch of microinverters is not producing and the IQ Envoy LEDs are off:



- Test at the main lugs for L-L and L-N voltages. The results should be around 240 VAC and 120 VAC respectively. If not, there may be a problem with the wiring from the panel.

# SAFETY

## IMPORTANT SAFETY INSTRUCTIONS SAVE THESE INSTRUCTIONS

Follow these important instructions during installation and maintenance of the IQ Combiner 3.

### Safety and Advisory Symbols

















	<b>DANGER:</b> This indicates a hazardous situation, which if not avoided, will result in death or serious injury.
	<b>WARNING:</b> This indicates a situation where failure to follow instructions may be a safety hazard or cause equipment malfunction. Use extreme caution and follow instructions carefully.
	<b>NOTE:</b> This indicates information particularly important for optimal system operation. Follow instructions carefully.









**FCC Statement:** This equipment has been tested and found to comply with the limits for a Class B digital device, pursuant to part 15 of the FCC Rules. These limits are designed to provide reasonable protection against harmful interference in a residential installation. This equipment generates, uses and can radiate radio frequency energy and, if not installed and used in accordance with the instructions, may cause harmful interference to radio communications. However, there is no guarantee that interference will not occur in a particular installation. If this equipment does cause harmful interference to radio or television reception, which can be determined by turning the equipment off and on, you are encouraged to try to correct the interference by one or more of the following measures:

- Reorient or relocate the receiving antenna.
  - Increase the separation between the equipment and the receiver.
  - Connect the equipment into an outlet on a circuit different from that to which the receiver is connected.
  - Consult the dealer or an experienced radio/TV technician for help.
- Changes or modifications not expressly approved by the party responsible for compliance may void the user's authority to operate the equipment.

This Class B digital apparatus complies with Industry Canada ICES-003.

### Safety Instructions

	<b>DANGER:</b> Risk of electric shock. Risk of fire. Do not attempt to repair the IQ Envoy; it contains no user-serviceable parts. Tampering with the IQ Envoy will void the warranty. If the IQ Envoy fails, contact Enphase Customer Support for assistance ( <a href="http://enphase.com/en-us/support/contact">enphase.com/en-us/support/contact</a> ).
	<b>DANGER:</b> Risk of electrocution! Do not install CTs when current flowing in the sensed circuit. Always install CT wires in the terminal blocks before energizing the sensed circuit.
	<b>DANGER:</b> Risk of electric shock. Do not use Enphase equipment in a manner not specified by the manufacturer. Doing so may cause death or injury to persons, or damage to equipment.
	<b>DANGER:</b> Risk of electric shock. Be aware that installation of this equipment includes risk of electric shock. Do not install the IQ Combiner 3 without first removing AC power from the Enphase System. Ensure the power coming from the microinverters is de-energized before servicing or installing.
	<b>DANGER:</b> Risk of electric shock. Risk of fire. Only qualified personnel should troubleshoot, install, or replace the IQ Combiner 3.
	<b>DANGER:</b> Risk of electric shock. Improper servicing of the IQ Combiner 3 or its components may result in a risk of shock, fire or explosion. To reduce these risks, disconnect all wiring before attempting any maintenance or cleaning.
	<b>DANGER:</b> Risk of electric shock. Always de-energize the AC branch circuit before servicing. While connectors are rated for disconnect under load, it is a best practice to de-energize before disconnecting.
	<b>DANGER:</b> Risk of electric shock. Risk of fire. Only use electrical system components approved for wet locations.
	<b>DANGER:</b> Risk of electric shock. Risk of fire. Ensure that all wiring is correct and that none of the wires are pinched or damaged.
	<b>DANGER:</b> Risk of electric shock. Risk of fire. Do not work alone. Someone should be in the range of your voice or close enough to come to your aid when you work with or near electrical equipment. Remove rings, bracelets, necklaces, watches etc. when working with batteries, photovoltaic modules or other electrical equipment.
	<b>DANGER:</b> Risk of electric shock. Risk of fire. Before making any connections verify that the circuit breaker(s) are in the off position. Double check all wiring before applying power.
	<b>DANGER:</b> Risk of electric shock. Risk of fire. Do not wire unused terminals or terminal blocks on the IQ Envoy.
	<b>WARNING:</b> Risk of electric shock. To maintain the warranty, do not modify the dead-front other than to remove filler plates, as needed.
	<b>WARNING:</b> Before installing or using the IQ Combiner 3, read all instructions and cautionary markings in the technical description and on the equipment.
	<b>WARNING:</b> Use the circuit breakers in the Enphase IQ Combiner 3 only for serving Enphase equipment. No other loads are allowed.
	<b>WARNING:</b> This unit is not provided with a GFDI device. This inverter or charge controller must be used with an external GFDI device as required by the Article 690 of the National Electrical Code for the installation location.

	<b>WARNING:</b> The IQ Combiner 3 has a pre-installed heat shield attached to the enclosure door. Do not remove the heat shield.
	<b>WARNING:</b> This product is intended for operation in an environment having a maximum ambient temperature of 46°C (115°F).
	<b>WARNING:</b> BONDING BETWEEN CONDUIT CONNECTIONS IS NOT AUTOMATIC AND MUST BE PROVIDED AS PART OF THE INSTALLATION.
	<b>NOTE:</b> Perform all wiring in accordance with all applicable local electrical codes, with the Canadian Electrical Code, Part I, and with the National Electrical Code (NEC), ANSI/NFPA 70.
	<b>NOTE:</b> Protection against lightning and resulting voltage surge must be in accordance with local standards.
	<b>NOTE:</b> Using unapproved attachments or accessories could result in damage or injury.
	<b>NOTE:</b> Install the IQ Combiner 3 in the field with 75°C or higher copper conductors sized per local code requirements and voltage drop/rise considerations.
	<b>NOTE:</b> Use Class 1 wiring methods for field wiring connections to terminals of a Class 2 circuit. Use 14 to 6 AWG wire for branch circuits and 14 to 3 AWG for output circuits. Select the wire gauge used based on the protection provided by the circuit breaker(s)/fuses. Overcurrent protection must be installed as part of the system installation.
	<b>NOTE:</b> To ensure optimal reliability and to meet warranty requirements, the Enphase IQ Combiner 3 must be installed according to the instructions in this manual.





# Enphase IQ 7A Microinverter

The high-powered smart grid-ready **Enphase IQ 7A Micro™** dramatically simplifies the installation process while achieving the highest system efficiency for systems with 60-cell and 72-cell modules.

Part of the Enphase IQ System, the IQ 7A Micro integrates with the Enphase IQ Envoy™, Enphase IQ Battery™, and the Enphase Enlighten™ monitoring and analysis software.

The IQ Series Microinverters extend the reliability standards set forth by previous generations and undergo over a million hours of power-on testing, enabling Enphase to provide an industry-leading warranty of up to 25 years.

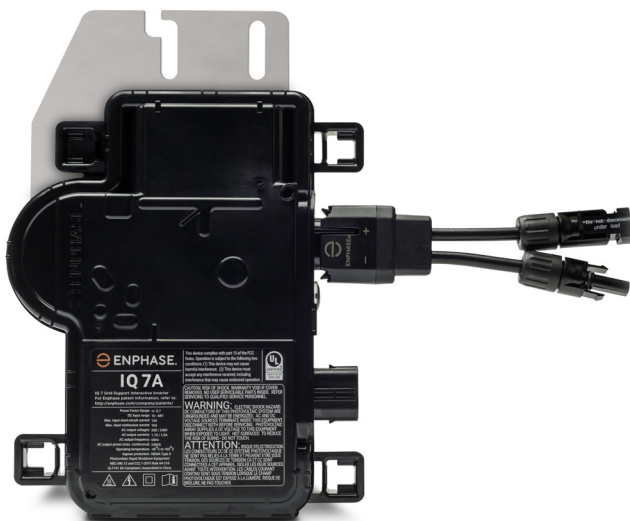

## High Power

- Peak output power 366 VA @ 240 VAC and 295 VA @ 208 VAC

## Easy to Install

- Lightweight and simple
- Faster installation with improved, lighter two-wire cabling
- Built-in rapid shutdown compliant (NEC 2014 & 2017)

## Efficient and Reliable

- Optimized for high powered 60-cell and 72-cell modules
- Highest CEC efficiency of 97%
- More than a million hours of testing
- Class II double-insulated enclosure
- UL listed

## Smart Grid Ready

- Complies with advanced grid support, voltage and frequency ride-through requirements
- Envoy and Internet connection required
- Configurable for varying grid profiles
- Meets CA Rule 21 (UL 1741-SA)



# Enphase IQ 7A Microinverter

<b>INPUT (DC)</b>		<b>IQ7A-72-2-US</b>	
Commonly used module pairings <sup>1</sup>	295 W–460 W +		
Module compatibility	60-cell, 66-cell, and 72-cell PV modules		
Maximum input DC voltage	58 V		
Power point tracking voltage range <sup>2</sup>	18 V–58 V		
Min/Max start voltage	30 V / 58 V		
Max DC short circuit current (module I <sub>sc</sub> ) <sup>3</sup>	15 A		
Overvoltage class DC port	II		
DC port backfeed current	0 A		
PV array configuration	1 x 1 ungrounded array; No additional DC side protection required; AC side protection requires max 20A per branch circuit		
<b>OUTPUT (AC)</b>		<b>@ 240 VAC</b>	<b>@ 208 VAC</b>
Peak output power	366 VA	295 VA	
Maximum continuous output power	349 VA	290 VA	
Nominal (L-L) voltage/range <sup>4</sup>	240 V / 211–264 V	208 V / 183–229 V	
Maximum continuous output current	1.45 A (240 VAC)	1.39 A (208 VAC)	
Nominal frequency	60 Hz		
Extended frequency range	47–68 Hz		
AC short circuit fault current over 3 cycles	5.8 Arms		
Maximum units per 20 A (L-L) branch circuit <sup>5</sup>	11 (240 VAC)	11 (208 VAC)	
Overvoltage class AC port	III		
AC port backfeed current	18 mA		
Power factor setting	1.0		
Power factor (adjustable)	0.85 leading ... 0.85 lagging		
<b>EFFICIENCY</b>		<b>@240 VAC</b>	<b>@208 VAC</b>
CEC weighted efficiency	97.0 %	96.5%	
<b>MECHANICAL</b>			
Ambient temperature range	-40°C to +60°C		
Relative humidity range	4% to 100% (condensing)		
Connector type: DC (IQ7A-72-2-US)	MC4		
Dimensions (WxHxD)	212 mm x 175 mm x 30.2 mm (without bracket)		
Weight	1.08 kg (2.38 lbs)		
Cooling	Natural convection – No fans		
Approved for wet locations	Yes		
Pollution degree	PD3		
Enclosure	Class II double-insulated, corrosion resistant polymeric enclosure		
Environmental category / UV exposure rating	NEMA Type 6 / outdoor		
<b>FEATURES</b>			
Communication	Power Line Communication (PLC)		
Monitoring	Enlighten Manager and MyEnlighten monitoring options Compatible with Enphase IQ Envoy		
Disconnecting means	The AC and DC connectors have been evaluated and approved by UL for use as the load-break disconnect required by NEC 690.		
Compliance	CA Rule 21 (UL 1741-SA) UL 62109-1, UL1741/IEEE1547, FCC Part 15 Class B, ICES-0003 Class B, CAN/CSA-C22.2 NO. 107.1-01 This product is UL Listed as PV Rapid Shut Down Equipment and conforms with NEC-2014 and NEC-2017 section 690.12 and C22.1-2015 Rule 64-218 Rapid Shutdown of PV Systems, for AC and DC conductors, when installed according manufacturer's instructions.		

1. No enforced DC/AC ratio. See the compatibility calculator at <https://enphase.com/en-us/support/module-compatibility>.

2. CEC peak power tracking voltage range is 38 V to 43 V.

3. Maximum continuous input DC current is 10.2A.

4. Voltage range can be extended beyond nominal if required by the utility.

5. Limits may vary. Refer to local requirements to define the number of microinverters per branch in your area.

To learn more about Enphase offerings, visit [enphase.com](https://enphase.com)

# Enphase IQ 7, IQ 7+, IQ 7X, and IQ 7A Micros



## Corporate Headquarters Contact Information

Enphase Energy Inc.  
1420 N. McDowell Blvd.  
Petaluma, CA 94954  
USA

[enphase.com/en-us/support/contact](https://enphase.com/en-us/support/contact)

## FCC Compliance

This equipment has been tested and found to comply with the limits for a Class B digital device, pursuant to part 15 of the FCC Rules. These limits are designed to provide reasonable protection against harmful interference in a residential installation. This equipment generates, uses and can radiate radio frequency energy and, if not installed and used in accordance with the instructions, may cause harmful interference to radio communications. However, there is no guarantee that interference will not occur in a particular installation. If this equipment does cause harmful interference to radio or television reception, which can be determined by turning the equipment off and on, you are encouraged to try to correct the interference by one or more of the following measures:

- Reorient or relocate the receiving antenna.
- Increase the separation between the equipment and the receiver.
- Connect the equipment into an outlet on a circuit different from that to which the receiver is connected.
- Consult the dealer or an experienced radio/TV technician for help.

Changes or modifications not expressly approved by the party responsible for compliance may void the user's authority to operate the equipment.

## Other Information

Product information is subject to change without notice. All trademarks are recognized as the property of their respective owners.

User documentation is updated frequently; Check the Enphase website ([enphase.com/support](https://enphase.com/support)) for the latest information.

To ensure optimal reliability and to meet warranty requirements, the Enphase Microinverter must be installed according to the instructions in this manual. For warranty text refer to [enphase.com/warranty](https://enphase.com/warranty).

For Enphase patent information refer to [enphase.com/company/patents/](https://enphase.com/company/patents/).

© 2020 Enphase Energy Inc. All rights reserved. Enphase, the Enphase logo, IQ 7, IQ 7+, IQ 7X, IQ 7A, IQ Envoy, IQ Combiner, IQ Microinverter, Installer Toolkit, Enlighten and other trademarks or service names are the trademarks of Enphase Energy, Inc. Data subject to change.

## Audience

This manual is intended for use by professional installation and maintenance personnel.

## Table of Contents

Important Safety Information .....	5
Read this First .....	5
Product Labels .....	5
Safety and Advisory Symbols.....	5
IQ 7 Microinverter Safety Instructions .....	5
PV Rapid Shutdown Equipment (PVRSE) .....	7
The Enphase IQ System.....	8
How the Enphase IQ Series Micros Work .....	9
System Monitoring .....	9
Optimal Reliability .....	9
Ease of Design.....	9
Planning for Microinverter Installation.....	10
Compatibility.....	10
Grounding Considerations.....	10
Branch Circuit Capacity.....	11
Utility Service Requirements .....	11
Wire Lengths and Voltage Rise.....	11
Lightning and Surge Suppression .....	12
Parts and Tools Required.....	12
Enphase Equipment.....	12
Other Items.....	12
Enphase Microinverter Installation.....	13
Step 1: Position the Enphase Q Cable.....	14
Step 2: Position the Enphase Q Aggregator or Junction Box .....	14
Step 3: Mount the Microinverters .....	15
Step 4: Create an Installation Map.....	16
Step 5: Manage the Cabling.....	17
Step 6: Connect the Microinverters .....	17
Step 7: Terminate the Unused End of the Cable.....	18
Step 8: Complete Installation of the Enphase Q Aggregator or Junction Box.....	19
Step 9: Connect the PV Modules .....	19
Step 10: Energize the System.....	20
Set Up and Activate Monitoring.....	20
Troubleshooting.....	21
Status LED Indications and Error Reporting .....	21
LED Operation .....	21
DC Resistance Low – Power Off Condition .....	21
Other Faults .....	22
Troubleshoot an Inoperable Microinverter.....	23
Disconnect a Microinverter.....	24
Install a Replacement Microinverter .....	25
Ordering Replacement Parts.....	27
Enphase Q Cable Planning and Ordering .....	27

Connector Spacing Options .....	27
Cabling Options.....	27
Enphase Q Cable Accessories.....	28
Technical Data.....	29
Technical Considerations .....	29
Specifications .....	30
IQ7-60-2-US Microinverter Specifications.....	30
IQ7PLUS-72-2-US Microinverter Specifications .....	33
IQ7X-96-2-US Microinverter Specifications .....	35
IQ7A-72-2-US Microinverter Specifications .....	37
Q Cable Specifications.....	39
Enphase Connector Ratings.....	39
Enphase Installation Map .....	40
Sample Wiring Diagram: .....	41

# Important Safety Information

## Read this First

This manual contains important instructions for use during installation and maintenance of the IQ 7™ Series Microinverters

**IMPORTANT:** Enphase IQ Series Microinverters require the Q Cable and are not compatible with previous Enphase cabling. An IQ Envoy is required to monitor performance of the IQ Microinverters. The Q Accessories work only with Enphase IQ Series Microinverters.

## Product Labels

The following symbols appear on the **product label** and are described here:



**WARNING:** Hot surface.



**DANGER:** Refer to safety instructions.



**DANGER:** Risk of electrical shock.







**Refer to manual**



**Double-insulated**

## Safety and Advisory Symbols



To reduce the risk of electric shock, and to ensure the safe installation and operation of the Enphase IQ System, the following safety symbols appear throughout this document to indicate dangerous conditions and important safety instructions.

	<b>DANGER:</b>	This indicates a hazardous situation, which if not avoided, will result in death or serious injury.
	<b>WARNING:</b>	This indicates a situation where failure to follow instructions may be a safety hazard or cause equipment malfunction. Use extreme caution and follow instructions carefully.
	<b>WARNING:</b>	This indicates a situation where failure to follow instructions may result in burn injury.
	<b>NOTE:</b>	This indicates information that is very important for optimal system operation. Follow instructions closely.







## IQ 7 Microinverter Safety Instructions

### General Safety

	<b>DANGER:</b> Risk of electric shock. Risk of fire.	Only use electrical system components approved for wet locations.
		Only qualified personnel should install, troubleshoot, or replace Enphase Microinverters or Enphase Q Cable and Accessories.
		Ensure that all AC and DC wiring is correct and that none of the AC or DC wires are pinched, shorted or damaged. Ensure that all AC junction boxes are properly closed.
		Do not exceed the maximum number of microinverters in an AC branch circuit as listed in the manual. You must protect each microinverter AC branch circuit with a 20 A maximum breaker or fuse as appropriate.











	<b>DANGER:</b> Risk of electric shock.	Do not use Enphase equipment in a manner not specified by the manufacturer. Doing so may cause death or injury to persons, or damage to equipment.
		Be aware that installation of this equipment includes risk of electric shock.
		The DC conductors of this photovoltaic system are ungrounded and may be energized.
		Always de-energize the AC branch circuit before servicing. While connectors are rated for disconnect under load, Enphase does not recommend disconnecting the DC connectors under load.
	<b>WARNINGS:</b>	Before installing or using the Enphase Microinverter, read all instructions and cautionary markings in the technical description, on the Enphase equipment and on the photovoltaic (PV) equipment.
		Do not connect Enphase Microinverters to the grid or energize the AC circuit(s) until you have completed all of the installation procedures and have received approval from the electrical utility.
		When the PV array is exposed to light, DC voltage is supplied to the power conversion equipment (PCE).
		Risk of equipment damage. Enphase male and female connectors must only be mated with the matching male/female connector.
	<b>NOTES:</b>	To ensure optimal reliability and to meet warranty requirements, install the Enphase equipment according to the instructions in this manual.
		The AC and DC connectors on the cabling are rated as a disconnect only when used with an Enphase Microinverter.
		Protection against lightning and resulting voltage surge must be in accordance with local standards.
		Perform all electrical installations in accordance with all applicable local electrical codes, such as: the Canadian Electrical Code, Part 1; ANSI requirements; and NPFA 70 (NEC).

### Microinverter Safety

	<b>WARNING:</b> Risk of skin burn.	The chassis of the Enphase Microinverter is the heat sink. Under normal operating conditions, the temperature could be 20° C above ambient, but under extreme conditions the microinverter can reach a temperature of 90° C. To reduce risk of burns, use caution when working with microinverters.
	<b>DANGER:</b> Risk of fire.	The DC conductors of the PV module must be labeled "PV Wire" or "PV Cable" when paired with the Enphase Microinverter.
	<b>DANGER:</b> Risk of electric shock. Risk of fire.	Only qualified personnel may connect the Enphase Microinverter to the utility grid. Do not attempt to repair the Enphase Microinverter; it contains no user-serviceable parts. If it fails, contact Enphase customer service to obtain a return merchandise authorization (RMA) number and start the replacement process. Tampering with or opening the Enphase Microinverter will void the warranty.
	<b>WARNING:</b> Risk of equipment damage	Install the microinverter under the PV module to avoid direct exposure to rain, UV, and other harmful weather events. Always install the microinverter bracket side up. Do not mount the microinverter upside down. Do not expose the AC or DC connectors (on the Enphase Q Cable, PV module, or the microinverter) to rain or condensation before the connectors are mated.
		The maximum open circuit voltage of the PV module must not exceed the specified maximum input DC voltage of the Enphase Microinverter.
	<b>WARNING:</b> Risk of equipment damage	You must match the DC operating voltage range of the PV module with the allowable input voltage range of the Enphase Microinverter.
		The Enphase Microinverter is not protected from damage due to moisture trapped in cabling systems. Never mate microinverters to cables that have been left disconnected and exposed to wet conditions. This voids the Enphase warranty.
		The Enphase Microinverter functions only with a standard, compatible PV module with appropriate fill-factor, voltage, and current ratings. Unsupported devices include smart PV modules, fuel cells, wind or water turbines, DC generators, and non-Enphase batteries, etc. These devices do not behave like standard PV modules, so operation and compliance are not guaranteed. These devices may also damage the Enphase Microinverter by exceeding its electrical rating, making the system potentially unsafe.
	<b>NOTES:</b>	The Enphase Microinverter has field-adjustable voltage and frequency trip points that may need to be set, depending upon local requirements. Only an authorized installer with the permission and following requirements of the local electrical authorities should make adjustments.



## Enphase Q Cable Safety

	<b>DANGER:</b> Risk of electric shock.	Do not install the Enphase Q Cable terminator while power is connected.
	<b>WARNING:</b> Risk of electric shock. Risk of fire.	When stripping the sheath from the Q Cable, make sure the conductors are not damaged. If the exposed wires are damaged, the system may not function properly.
	<b>WARNING:</b>	Do not leave AC connectors on the Q Cable uncovered for an extended period. You must cover any unused connector with a sealing cap.
	<b>WARNING:</b>	Make sure protective sealing caps have been installed on all unused AC connectors. Unused AC connectors are live when the system is energized.
	<b>WARNING:</b>	Use the terminator only once. If you open the terminator following installation, the latching mechanism is destroyed. If the latching mechanism is defective, do not use the terminator. Do not circumvent or manipulate the latching mechanism.
	<b>WARNING:</b>	When installing the Enphase Q Cable, secure any loose cable to minimize tripping hazard.
	<b>NOTES:</b>	When looping the Enphase Q Cable, do not form loops smaller than 4.75" (12 cm) in diameter.
	<b>NOTES:</b>	Provide support for the Enphase Q-Cable every 1.8m (6 feet).
	<b>NOTES:</b>	If you need to remove a sealing cap, you must use the Enphase disconnect tool.
	<b>NOTES:</b>	<p>When installing the Enphase Q Cable and accessories, adhere to the following:</p> <ul style="list-style-type: none"> <li>• Do not expose the terminator cap or cable connections to directed, pressurized liquid (water jets, etc.).</li> <li>• Do not expose the terminator or cable to continuous immersion.</li> <li>• Do not expose the terminator cap or cable connections to continuous tension (e.g., tension due to pulling or bending the cable near the connection).</li> <li>• Use only the connectors provided.</li> <li>• Do not allow contamination or debris in the connectors.</li> <li>• Use the terminator cap and cable connections only when all parts are present and intact.</li> <li>• Do not install or use in potentially explosive environments.</li> <li>• Do not allow the terminator to come into contact with open flame.</li> <li>• Fit the terminator cap using only the prescribed tools and in the prescribed manner.</li> <li>• Use the terminator to seal the conductor end of the Enphase Q Cable; no other method is allowed.</li> </ul>

## PV Rapid Shutdown Equipment (PVRSE)

This product is UL Listed as PV Rapid Shut Down Equipment and conforms with NEC-2014 and NEC-2017 section 690.12 and C22.1-2015 Rule 64-218 Rapid Shutdown of PV Systems, for AC and DC conductors, when installed according to the following requirements:

- Microinverters and all DC connections must be installed inside the array boundary. Enphase further requires that the microinverters and DC connections be installed under the PV module to avoid direct exposure to rain, UV, and other harmful weather events.
- The array boundary is defined as 305 mm (1 ft.) from the array in all directions, or 1 m (3 ft.) from the point of entry inside a building.

This rapid shutdown system must be provided with an initiating device and (or with) status indicator which must be installed in a location accessible to first responders, or it must be connected to an automatic system which initiates rapid shutdown upon the activation of a system disconnect or activation of another type of emergency system.

The initiator shall be listed and identified as a disconnecting means that plainly indicates whether it is in the "off" or "on" position. Examples are:

- Service disconnecting means
- PV system disconnecting means
- Readily accessible switch or circuit breaker

The handle position of a switch or circuit breaker is suitable for use as an indicator. Refer to NEC or CSA C22.1-2015 for more information.

Additionally, in a prominent location near the initiator device, a placard or label must be provided with a permanent marking including the following wording:

'PHOTOVOLTAIC SYSTEM EQUIPPED WITH RAPID SHUTDOWN' The term 'PHOTOVOLTAIC' may be replaced with 'PV.'

The placard, label, or directory shall be reflective, with all letters capitalized and having a minimum height of 9.5 mm (3/8") in white on red background.

## The Enphase IQ System

The Enphase IQ System includes:

- **Enphase IQ 7™<sub>V</sub>, IQ 7+™, IQ 7A™ and IQ 7X™ Micros** The smart grid ready IQ Series Micros convert the DC output of the PV module into grid-compliant AC power.
- **Enphase IQ Envoy™ (ENV-IQ-AM1-240)** The Enphase IQ Envoy is a communication device that provides network access to the PV array. The IQ Envoy collects production and performance data from the Enphase IQ Microinverters over on-site AC power lines and transmits the data to Enlighten through an Internet or cellular modem connection. The IQ Envoy is capable of monitoring up to 600 Enphase IQ Microinverters and up to 39 Enphase IQ Batteries. For details, refer to *Enphase IQ Envoy Installation and Operations Manual*.



**NOTE:** All 208 VAC installations require that you use the Enphase IQ Envoy to commission the Enphase Microinverters to propagate correct grid profile settings for 208 VAC trip points.

- **Enphase Enlighten™** web-based monitoring and management software. Installers can use Enlighten Manager to view detailed performance data, manage multiple PV systems, and remotely resolve issues that might impact system performance. Find out more at [enphase.com/enlighten](http://enphase.com/enlighten).
- **Enphase Installer Toolkit™** mobile app for iOS and Android devices. It allows installers to configure the system while onsite, eliminating the need for a laptop and improving installation efficiency. You can use the app to:
  - Connect to the IQ Envoy over a wireless network for faster system setup and verification
  - View and email a summary report that confirms a successful installation
  - Scan device serial numbers and sync system information with Enlighten monitoring software
- **Enphase Q Aggregator (Q-BA-3-1P-60)** Aggregates up to three fully populated 20A branch circuits and supports solar arrays of up to 11.5kWac with a single rooftop aggregator
- **Enphase IQ Battery™ (IQ6PLUS-B1200-LL-I-US00-RV1)**
- **Enphase Field Wireable connectors (Q-CONN-10F and Q-CONN-10M)** Make connections from any Q Cable, or open Field Wireable connector.

This manual describes the safe installation and operation of the Enphase Microinverter.



**NOTE:** To ensure optimal reliability and to meet warranty requirements, the Enphase Microinverter must be installed according to the instructions in this manual.

## How the Enphase IQ Series Micros Work

The Enphase Microinverter maximizes energy production by using a sophisticated Maximum Power Point Tracking (MPPT) algorithm. Each Enphase Microinverter individually connects to one PV module in your array. This configuration enables an individual MPPT to control each PV module, ensuring that maximum power available from each PV module is exported to the utility grid regardless of the performance of the other PV modules in the array. While an individual PV module in the array may be affected by shading, soiling, orientation, or PV module mismatch, each Enphase Microinverter ensures top performance for its associated PV module.

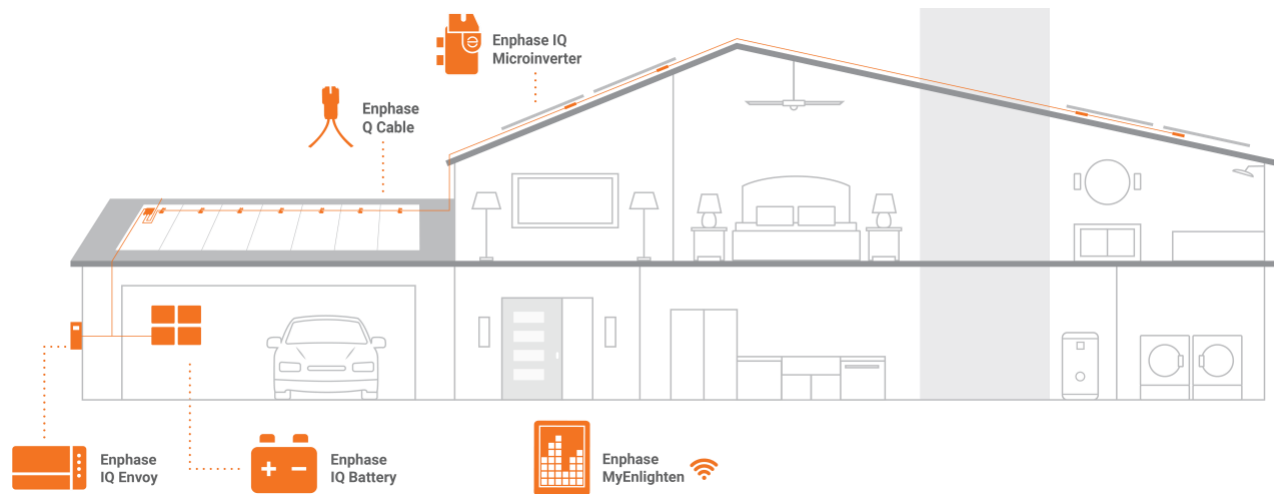

## System Monitoring

Once you install the Enphase IQ Envoy and provide an internet connection through a broadband router or modem, the Enphase IQ Microinverters automatically begin reporting to Enlighten. Enlighten presents current and historical system performance trends and informs you of PV system status.

## Optimal Reliability

Microinverter systems are inherently more reliable than traditional inverters. The distributed nature of a microinverter system ensures that there is no single point of system failure in the PV system. Enphase Microinverters are designed to operate at full power at ambient temperatures as high as 65° C (150° F).

## Ease of Design

PV systems using Enphase Microinverters are very simple to design and install. You will not need string calculations or cumbersome traditional inverters. You can install individual PV modules in any combination of PV module quantity, type, age and orientation. Each microinverter quickly mounts on the PV racking, directly beneath each PV module. Low voltage DC wires connect from the PV module directly to the co-located microinverter, eliminating the risk of personnel exposure to dangerously high DC voltage.

## Planning for Microinverter Installation

The Enphase IQ 7 Micro is compatible with 60-cell PV modules, and the IQ 7+ Micro and IQ 7A Micro support PV modules with 60 or 72 Cells. The IQ 7X requires a 96-cell PV module. All of them install quickly and easily. The microinverter housing is designed for outdoor installation and complies with the NEMA 250, type 6 environmental enclosure rating standard:



**NEMA 6 rating definition:** Indoor or outdoor use primarily to provide a degree of protection against hose-directed water, the entry of water during occasional temporary submersion at a limited depth, and damage from external ice formation

The Enphase Q Cable is available with connector spacing options to accommodate installation of PV modules in portrait or landscape orientation. For Enphase Q Cable ordering information, see “Enphase Q Cable Planning and Ordering” on page 27.

### Compatibility

The Enphase IQ Series Micros are **electrically compatible** with PV modules as listed in the following table. For specifications, see “Technical Data” on page 29 of this manual. You can refer to the Enphase Compatibility Calculator at: [enphase.com/en-us/support/module-compatibility](https://enphase.com/en-us/support/module-compatibility) to verify PV module electrical compatibility. To ensure **mechanical compatibility**, be sure to order the correct connector type for both microinverter and PV module from your distributor.



**WARNING:** Risk of fire. The PV module DC conductors must be labeled "PV Wire" or "PV Cable" to comply with NEC for Ungrounded PV Power Systems.

Microinverter model	Connector type	PV module cell count
IQ7A-72-2-US	MC-4 locking type	Pair with 60 or 72-cell modules. IQ7A installs are not recommended with bifacial modules and use of such may impact the limited warranty.
IQ7-60-2-US	MC-4 locking type	Pair only with 60-cell modules
IQ7PLUS-72-2-US	MC-4 locking type	Pair with 60 or 72-cell modules
IQ7X-96-2-US	MC-4 locking type	Pair only with 96-cell modules
IQ7A-72-2-US	MC-4 locking type	Pair with 60 or 72-cell modules

### Grounding Considerations

The Enphase Microinverter models listed in this guide do not require grounding electrode conductors (GEC), equipment grounding conductors (EGC), or grounded conductor (neutral). Your Authority Having Jurisdiction (AHJ) may require you to bond the mounting bracket to the racking. If so, use UL2703 hardware or star washers. The microinverter itself has a Class II double-insulated rating, which includes ground fault protection (GFP). To support GFP, use only PV modules equipped with DC cables labeled PV Wire or PV Cable.

## Branch Circuit Capacity

Plan your AC branch circuits to meet the following limits for maximum number of microinverters per branch when protected with a 20 amp (maximum) over current protection device (OCPD).

Maximum* IQ 7 Micros per AC branch circuit (240 VAC)	Maximum* IQ 7+ Micros per AC branch circuit (240 VAC)	Maximum* IQ 7X Micros per AC branch circuit (240 VAC)	Maximum* IQ 7A Micros per AC branch circuit (240 VAC)
16	13	12	11
Maximum* IQ 7 Micros per AC branch circuit (208 VAC)	Maximum* IQ 7+ Micros per AC branch circuit (208 VAC)	Maximum* IQ 7X Micros per AC branch circuit (208 VAC)	Maximum* IQ 7A Micros per AC branch circuit (208 VAC)
13	11	10	11



**NOTE:** \*Limits may vary. Refer to local requirements to define the number of microinverters per branch in your area.

## Utility Service Requirements

The Enphase IQ Series Micros work with single-phase service. Measure AC line voltages at the electrical utility connection to confirm that it is within the ranges shown:

240 Volt AC, Single Phase	
L1 to L2	211 to 264 VAC
L1, L2 to ground	106 to 132 VAC
208 Volt AC, Single Phase	
L1 to L2	183 to 229 VAC
L1, L2 to ground	106 to 132 VAC



**NOTE:** All 208 VAC installations require that you use the Enphase IQ Envoy to commission the Enphase Microinverters to propagate correct grid profile settings for 208 VAC trip points.

## Wire Lengths and Voltage Rise

When planning the system, you must select the appropriate AC conductor size to minimize voltage rise. Select the correct wire size based on the distance from the beginning of the microinverter AC branch circuit to the breaker in the load center. Enphase recommends a voltage rise total of less than 2% for the sections from the microinverter AC branch circuit to the breaker in the load center.

Enphase provides guidance about choosing wire size and maximum conductor lengths in the Voltage Rise Technical Brief at [enphase.com/support](http://enphase.com/support). Refer to this brief for voltage rise values in Enphase Q Cables and on how to calculate voltage rise in other wire sections of the system.

Standard guidelines for voltage rise on feeder and AC branch circuit conductors might not be sufficient for microinverter AC branch circuits that contain the maximum allowable microinverters. This is due to high inherent voltage rise on the AC branch circuit.



**Best practice:** Center-feed the branch circuit to minimize voltage rise in a fully-populated branch. This practice greatly reduces the voltage rise as compared with an end-fed branch. To center-feed a branch, divide the circuit into two sub-branch circuits protected by a single OCPD. Using the Q Aggregator is a convenient way to do this.

## Lightning and Surge Suppression

Enphase Microinverters have integral surge protection, greater than most traditional inverters. However, if the surge has sufficient energy, the protection built into the microinverter can be exceeded, and the equipment can be damaged. For this reason, Enphase recommends that you protect your system with a lightning and/or surge suppression device. In addition to having some level of surge suppression, it is also important to have insurance that protects against lightning and electrical surges. Enphase has tested the following devices:

- [Leviton 51110-SRG](#)
- [Schneider SquareD HEPD50](#)



**NOTE:** Protection against lightning and resulting voltage surge must be in accordance with local standards.

## Parts and Tools Required

In addition to the microinverters, PV modules, and racking, you will need the following:

### Enphase Equipment

- **Enphase IQ Envoy:** Required to monitor production. IQ Envoy (model ENV-IQ-AM1-240) communications gateway or IQ Combiner (model X-IQ-AM1-240-B, X-IQ-AM1-240-2, X-IQ-AM1-240-3, X-IQ-AM1-240-3C).
- **Enphase Installer Toolkit:** Download the Enphase Installer Toolkit mobile app, open it, and log in to your Enlighten account. Use it later to scan microinverter serial numbers and connect to the IQ Envoy to track system installation progress. To download, go to [enphase.com/toolkit](https://enphase.com/toolkit) or scan the QR code at right.
- **Tie wraps or Q Cable Clips** (Q-CLIP-100)
- **Enphase Sealing Caps** (Q-SEAL-10) for any unused drops on the Enphase Q Cable
- **Enphase Terminator** (Q-TERM-10) typically two needed per branch circuit
- **Enphase Disconnect Tool** (Q-DISC-10)
- **Enphase Field Wireable Connectors** (male and female: Q-CONN-10M and Q-CONN-10F)
- **Enphase Q Cable:**



Cable Model	Connector Spacing	PV Module Orientation	Connector Count per box
Q-12-10-240	1.3m	Portrait	240
Q-12-17-240	2.0m	Landscape (60-cell)	240
Q-12-20-200	2.3m	Landscape (72-cell)	200

### Other Items

- Enphase Q Aggregator or AC junction box
- Number 2 and 3 screwdrivers
- Wire cutters, voltmeter
- Torque wrench, sockets, wrenches for mounting hardware

# Enphase Microinverter Installation

Installing the Enphase IQ Series Micros involves several key steps. Each step listed here is detailed in the following pages.

- Step 1:** Position the Enphase Q Cable
- Step 2:** Position the Enphase Q Aggregator or Junction Box
- Step 3:** Mount the Microinverters
- Step 4:** Create an Installation Map
- Step 5:** Manage the Cabling
- Step 6:** Connect the Microinverters
- Step 7:** Terminate the Unused End of the Cable
- Step 8:** Complete Installation of the Enphase Q Aggregator or Junction Box
- Step 9:** Connect the PV Modules
  
- Step 10:** Energize the System

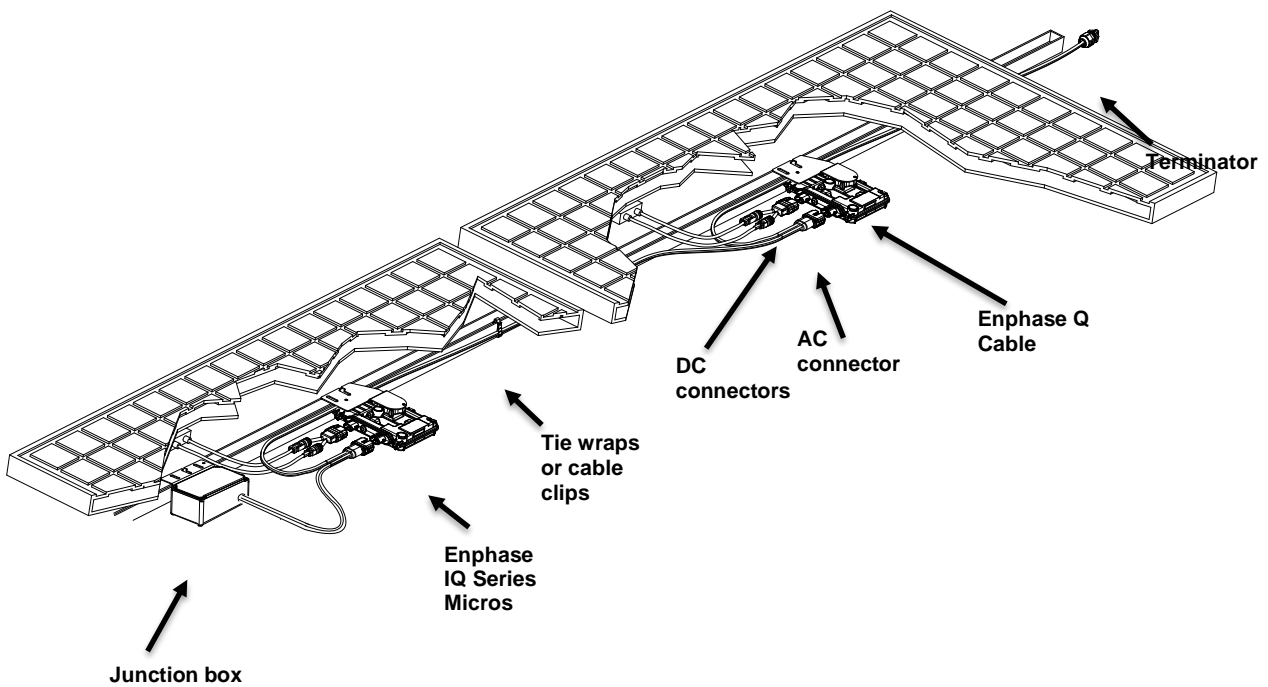

## Step 1: Position the Enphase Q Cable

- A. Plan each cable segment to allow drop connectors on the Enphase Q Cable to align with each PV module. Allow extra length for slack, cable turns, and any obstructions.
- B. Mark the approximate centers of each PV module on the PV racking.
- C. Lay out the cabling along the installed racking for the AC branch circuit.
- D. Cut each segment of cable to meet your planned needs.



**WARNING:** When transitioning between rows, secure the cable to the rail to prevent cable damage or connector damage. Do not count on connector to withstand tension.

## Step 2: Position the Enphase Q Aggregator or Junction Box

- A. Verify that AC voltage at the site is within range.

Service Type and Voltage: L1-L2	
240 VAC Split-Phase	211 to 264 VAC
208 VAC Single-Phase	183 to 229 VAC



**NOTE:** All 208 VAC installations require that you use the Enphase IQ Envoy to commission the Enphase Microinverters to propagate correct grid profile settings for 208 VAC trip points.

- B. Install an Enphase Q Aggregator or junction box at a suitable location on the racking.
- C. Provide an AC connection from the junction box back to the electricity network using equipment and practices as required by local jurisdictions.



### Step 3: Mount the Microinverters

- A. **Mount the microinverter bracket side up (as shown) and under the PV module, away from rain and sun.** Allow a minimum of 1.9 cm (3/4") between the roof and the microinverter. Also allow 1.3 cm (1/2") between the back of the PV module and the top of the microinverter.



**WARNING:** Install the microinverter under the PV module to avoid direct exposure to rain, UV and other harmful weather events. Do not mount the microinverter upside down.

**WARNING:** IQ7A installs are not recommended with bi-facial modules, and use of such may impact the limited warranty.

- B. Torque the microinverter fasteners as follows. **Do not over torque.**
- 6 mm (1/4") mounting hardware: 5 N m (45 to 50 in-lbs.)
  - 8 mm (5/16") mounting hardware: 9 N m (80 to 85 in-lbs.)
  - When using UL 2703 mounting hardware, use the manufacturer's recommended torque value

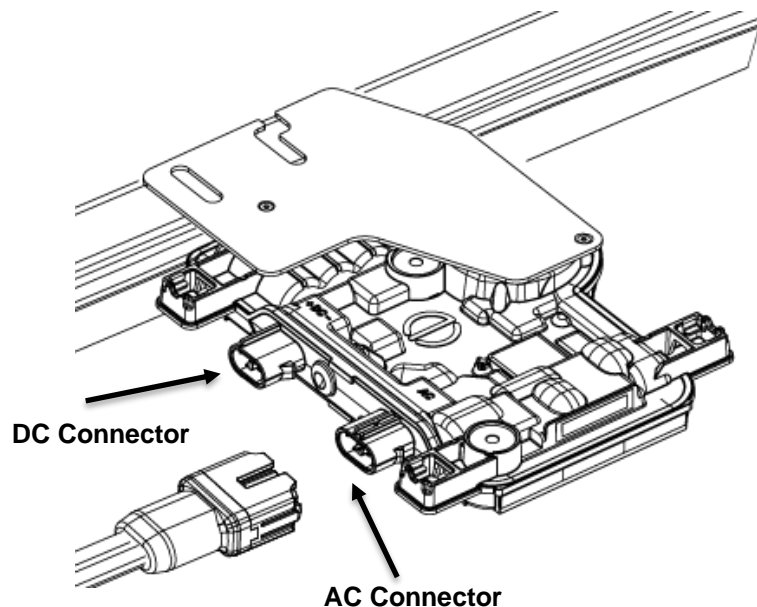

## Step 4: Create an Installation Map

The Enphase Installation Map is a diagram of the physical location of each microinverter in your PV installation. Copy or use the blank map on page 39 to record microinverter placement for the system or provide your own layout if you require a larger or more intricate installation map.

Each Enphase Microinverter, Envoy, and Battery have a removable serial number label. Build the installation map by peeling the serial number labels from the microinverter mounting plates and placing the labels on the map. You will also place the Enphase IQ Envoy and IQ Battery serial number on the map after installation.

After you have created the installation map, use the Enphase Installer Toolkit mobile app to record serial numbers and configure the system.

For details, refer to “Detect the Microinverters” in the help topics of the Installer Toolkit app.

- A. Peel the removable serial number label from each microinverter and affix it to the respective location on the paper installation map.
- B. Peel the label from the IQ Envoy and any Enphase Battery, if installed) and affix it to the installation map.
- C. Always keep a copy of the installation map for your records.

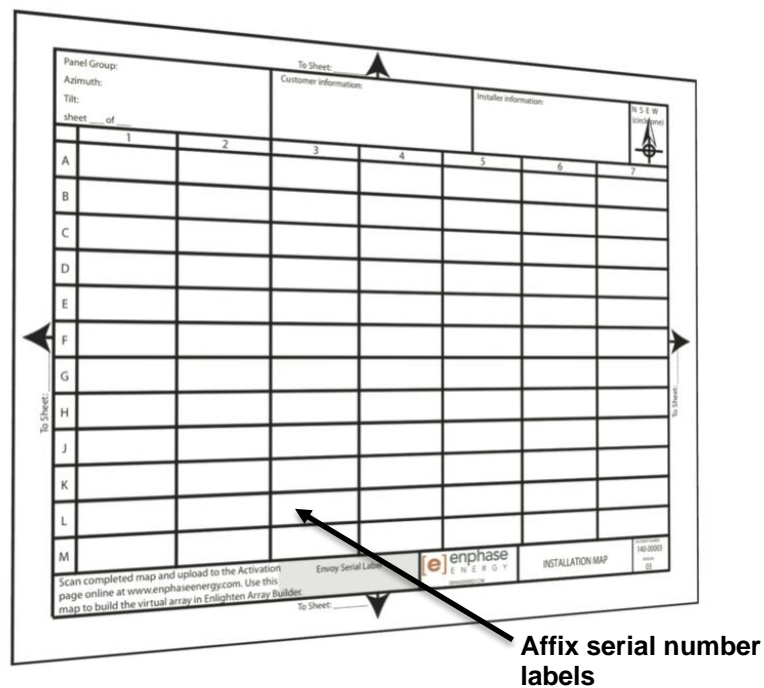

## Step 5: Manage the Cabling

- A. Use cable clips or tie wraps to attach the cable to the racking. Leave no more than 1.8 m (six feet) between cable clips or tie wraps.

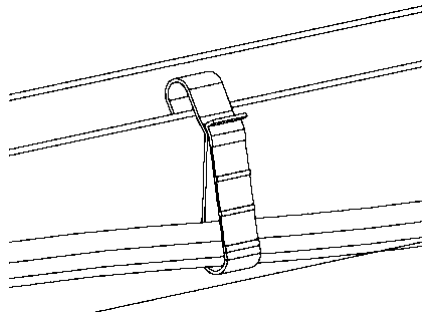

**Cable clip**

- B. Dress any excess cabling in loops so that it does not contact the roof. Do not form loops smaller than 12 cm (4¾ ") in diameter.



**WARNING:** Tripping Hazard. Loose cables can become a tripping hazard. Dress the Enphase Q Cable to minimize this potential.

## Step 6: Connect the Microinverters

- A. Connect the microinverter. Listen for a click as the connectors engage.
- B. Cover any unused connector with Enphase Sealing Caps. Listen for a click as the connectors engage.



**WARNING:** Risk of electric shock. Risk of fire. Install sealing caps on all unused AC connectors as these connectors become live when the system is energized. Sealing caps are required for protection against moisture ingress.



**NOTE:** If you need to remove a sealing cap, you must use the Enphase Disconnect Tool. See "Disconnect a Microinverter" on page 24.

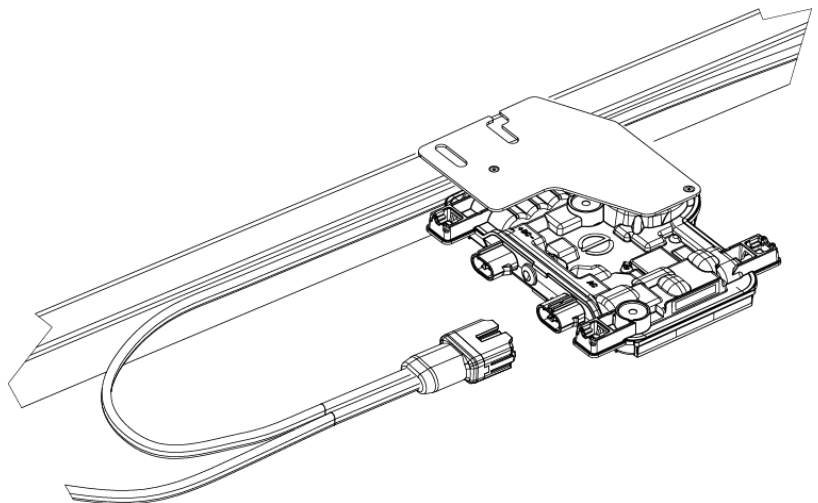

## Step 7: Terminate the Unused End of the Cable

Terminate the unused end of the Enphase Q Cable as follows.

- A. Remove 13 mm (½ inch) of the cable sheath from the conductors. Use the terminator loop to measure 13 mm.
- B. Slide the hex nut onto the cable. There is a grommet inside of the hex nut that should remain in place.
- C. Insert the cable into the terminator body so that each of the two wires land on opposite sides of the internal separator.

**Terminator Body**      **13mm**

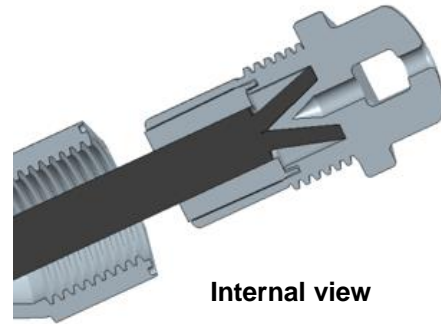
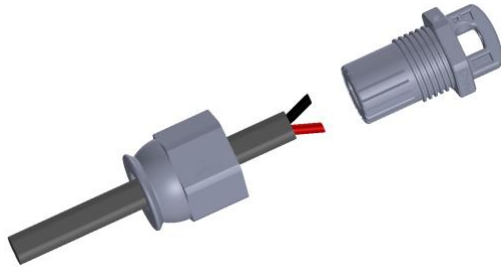
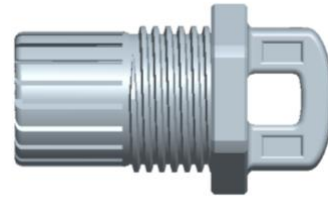

**Internal view**

- D. Insert a screwdriver into the slot on the top of the terminator to hold it in place, and torque the nut to 7 Nm.
- E. Hold the terminator body stationary with the screwdriver and turn only the hex nut to prevent the conductors from twisting out of the separator.



**NOTE:** Turn only the hex nut to prevent conductors from twisting out of the separator.

- F. Attach the terminated cable end to the PV racking with a cable clip or tie wrap so that the cable and terminator do not touch the roof.



**WARNING:** The terminator cannot be re-used. If you unscrew the nut, you must discard the terminator.

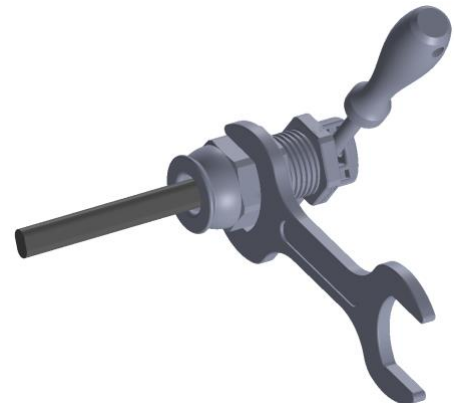

## Step 8: Complete Installation of the Enphase Q Aggregator or Junction Box

- Connect the Enphase Q Cable into the Enphase Q Aggregator or junction box.
- Use the ground lug on the Q Aggregator for module, rack, and balance of system grounding, if needed.
- Refer to the wiring diagrams on page 41 for more information. Wire colors are listed in the following table.

Wire Colors
L1 – Black
L2 – Red

## Step 9: Connect the PV Modules



**WARNING:** Electrical shock hazard. The DC conductors of this photovoltaic system are ungrounded and may be energized.

- If required, attach the Enphase DC bulkhead adaptors to the microinverters. Make sure they are fully seated. **Do not reverse the adaptor connections.**
- Connect the DC leads of each PV module to the DC input connectors of the corresponding microinverter.
- Check the LED on the connector side of the microinverter. The LED flashes six times when DC power is applied.
- Mount the PV modules above the microinverters.

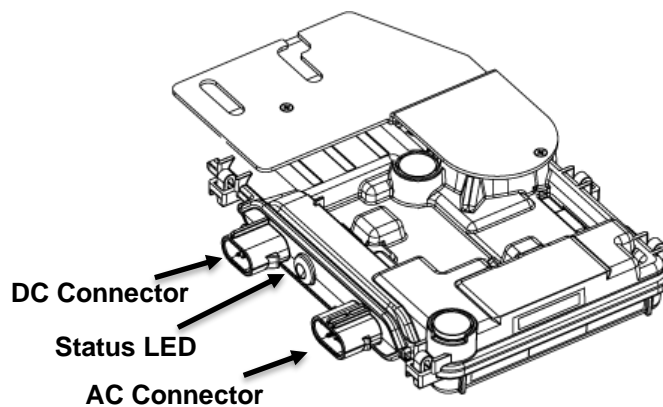

## Step 10: Energize the System

- A. Turn ON the AC disconnect or circuit breaker for the branch circuit.
- B. Turn ON the main utility-grid AC circuit breaker. Your system starts producing power **after a five-minute wait time.**
- C. Check the LED on the connector side of the microinverter:

LED color	Indicates
Flashing green	Normal operation. AC grid function is normal there is communication with the IQ Envoy.
Flashing orange	The AC grid is normal but there is no communication with the IQ Envoy.
Flashing Red	The AC grid is either not present or not within specification.
Solid Red	There is an active "DC Resistance Low, Power Off Condition." To reset, see "DC Resistance Low – Power Off Condition" on page 21.

## Set Up and Activate Monitoring

Refer to the *Enphase IQ Envoy Quick Install Guide* to install the IQ Envoy and set up system monitoring and grid management functions. This guide leads you through the following:

- Connecting the Envoy
- Detect devices
- Connecting to Enlighten
- Registering the system
- Building the virtual array



**NOTE:** When the utility requires a profile other than the default IEEE 1547 (for example grids managed by Hawaii Electric Industries [HEI] including HECO) you must select an appropriate grid profile for your installation. You can set the grid profile through Enlighten, during system registration, or through Installer Toolkit at any time. You must have an Enphase Envoy communications gateway to set or change the grid profile. For more information on setting or changing the grid profile, refer to the *Enphase IQ Envoy Installation and Operation Manual* at [enphase.com/support](https://enphase.com/support).

## Troubleshooting

Follow all the safety measures described throughout this manual. Qualified personnel can use the following troubleshooting steps if the PV system does not operate correctly.



**WARNING:** Risk of electric shock. Do not attempt to repair the Enphase Microinverter; it contains no user-serviceable parts. If it fails, contact Enphase customer service to obtain an RMA (return merchandise authorization) number and start the replacement process.

## Status LED Indications and Error Reporting

The following section describes LED indications.

### LED Operation

LED color	Indicates
Flashing green	Normal operation. AC grid function is normal there is communication with the Envoy.
Flashing orange	The AC grid is normal but there is no communication with the Envoy.
Flashing red	The AC grid is either not present or not within specification.
Solid red	There is an active “DC Resistance Low, Power Off Condition.” To reset, see “DC Resistance Low – Power Off Condition” on page 21.

The status LED on each microinverter lights green about six seconds after DC power is applied. It remains lit solid for two minutes, followed by six green blinks. After that, red blinks indicate that no grid is present if the system is not yet energized.

Any short red blinks after DC power is first applied to the microinverter indicate a failure during microinverter startup.

### DC Resistance Low – Power Off Condition

For all **IQ Series models**, a solid red status LED when DC power has been cycled indicates the microinverter has detected a DC Resistance Low – Power Off event. The LED will remain red and the fault will continue to be reported by the Envoy until the error has been cleared.

An insulation resistance (IR) sensor in the microinverter measures the resistance between the positive and negative PV inputs to ground. If either resistance drops below a threshold, the microinverter stops power production and raises this condition. This may indicate defective module insulation, defective wiring or connectors, moisture ingress, or a similar problem. Although the cause may be temporary, this microinverter condition persists until the sensor is manually reset.

**An IQ Envoy is required to clear this condition.** The condition clears on operator command unless its cause is still present.

If a microinverter registers a “DC Resistance Low - Power Off” condition, you can attempt to clear this condition. If the condition does not clear after you perform the following procedure, contact Enphase Energy customer support at [enphase.com/en-us/support/contact](https://enphase.com/en-us/support/contact).



There are two ways to send a clear message to the microinverter. Note that the condition will not clear after sensor reset if the cause of the failure is still present. If the condition persists, contact your installer.

**Method 1: Clear this Error Using Enlighten**

- Log in to Enlighten and access the system.
- Click the **Events** tab. The next screen shows a current “DC Resistance Low - Power Off” condition for the system.
- Click **DC Resistance Low - Power Off**.
- Where “n” is the number of affected devices, click **n devices (show details)**.
- Click the serial number of the affected microinverter.
- Click **Reset DC Resistance Low - Power Off Sensor**.  
The system displays, “A DC Resistance Low- Power Off reset task was issued on [date and time] for this microinverter and is still pending.”

**Method 2: Use Installer Toolkit to Clear the Condition**

On the list of detected microinverters, a green dot or red square appears to the left of each microinverter serial number. A green dot indicates Status OK. A red square indicates an event for that microinverter.

- Tap the  to the left of the serial number to view details for a microinverter event.
- If the microinverter status shows that there is an active **DC Resistance Low – Power Off** condition, tap the  to send the clear message to the affected microinverter. The app then indicates that a clear message was sent.

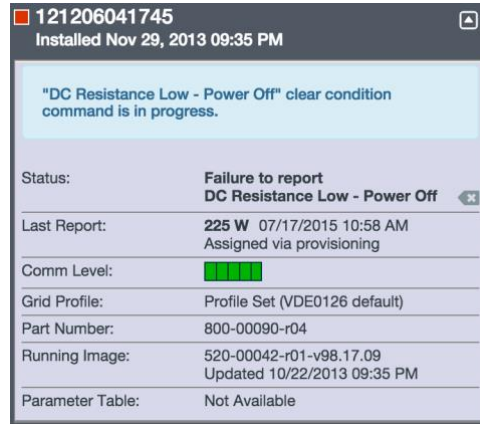
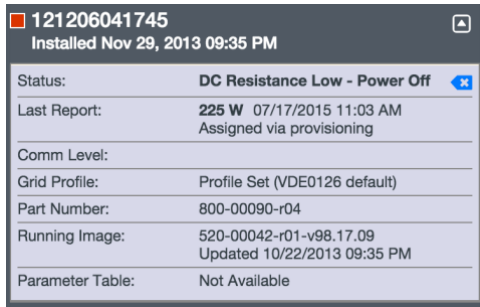

**Other Faults**

All other faults are reported to the Envoy. Refer to the *Enphase IQ Envoy Installation and Operation Manual* at [enphase.com/support](http://enphase.com/support) for troubleshooting procedures.



## Troubleshoot an Inoperable Microinverter

To troubleshoot an inoperable microinverter, follow the steps in the order shown.



**WARNING:** Risk of electric shock. Always de-energize the AC branch circuit before servicing. Never disconnect the DC connectors under load.



**WARNING:** The Enphase Microinverters are powered by DC power from the PV modules. Make sure you disconnect the DC connections and reconnect DC power and then watch for the solid green about six seconds after connection to DC power.

- A. Make sure AC breakers and disconnects are closed.
- B. Check the connection to the utility grid and verify that the utility voltage is within allowable ranges.
- C. Verify that AC line voltages at all solar power circuit breakers at the load center and subpanels are within the ranges shown in the following table.
- D. Verify that AC line voltage at the junction box for each AC branch circuit is within the ranges shown in the following table:

240 Volt AC, Single Phase	
L1 to L2	211 to 264 VAC
L1, L2 to ground	106 to 132 VAC
208 Volt AC, Single Phase	
L1 to L2	183 to 229 VAC
L1, L2 to ground	106 to 132 VAC

- E. Using an Enphase disconnect tool, disconnect the AC cable for the microinverter in question from the Enphase Q Cable.
- F. Verify that utility power is present at the microinverter by measuring line to line and line to ground at the Enphase Q Cable connector.
- G. Visually check that the AC branch circuit connections (Enphase Q Cable and AC connections) are properly seated. Reseat if necessary. Check also for damage, such as rodent damage.
- H. Make sure that any upstream AC disconnects, as well as the dedicated circuit breakers for each AC branch circuit, are functioning properly and are closed.
- I. Disconnect and re-connect the DC PV module connectors. The status LED of each microinverter will light solid green a few seconds after connection to DC power and then blink green six times to indicate normal start-up operation about two minutes after connecting to DC power. The LED subsequently resumes normal operation if the grid is present. See page 21 for normal LED operation.
- J. Attach an ammeter clamp to one conductor of the DC cables from the PV module to measure microinverter current. This will be under one amp if AC is disconnected.
- K. Verify the PV module DC voltage is within the allowable range shown in “Specifications” on page 30 of this manual.
- L. Swap DC leads with a known good, adjacent PV module. If after checking Enlighten periodically (this may take up to 30 minutes), the problem moves to the adjacent module, this

indicates that the PV module isn't functioning correctly. If it stays in place, the problem is with the original microinverter. Contact [Enphase Customer Support](#) for help in reading the microinverter data and for help in obtaining a replacement microinverter, if needed.

- M. Check the DC connections between the microinverter and the PV module. The connection may need to be tightened or reseated. If the connection is worn or damaged, it may need replacement.
- N. Verify with your utility that line frequency is within range.
- O. If the problem persists, contact Customer Support at [enphase.com/en-us/support/contact](https://enphase.com/en-us/support/contact).

## Disconnect a Microinverter

If problems remain after following the troubleshooting steps listed previously, contact Enphase at [enphase.com/en-us/support/contact](https://enphase.com/en-us/support/contact). If Enphase authorizes a replacement, follow the steps below. To ensure the microinverter is not disconnected from the PV modules under load, follow the disconnection steps in the order shown:

- A. De-energize the AC branch circuit breaker.
- B. Enphase AC connectors are tool-removable only. To disconnect the microinverter from the Enphase Q Cable, insert the disconnect tool and remove the connector.
- C. Cover the PV module with an opaque cover.
- D. Using a clamp-on meter, verify there is no current flowing in the DC wires between the PV module and the microinverter. If current is still flowing, check that you have completed steps one and two above.



**NOTE:** Take care when measuring DC current as most clamp-on meters must be zeroed first and tend to drift with time.

- E. Disconnect the PV module DC wire connectors from the microinverter using the Enphase disconnect tool.
- F. If present, loosen and/or remove any bonding hardware.
- G. Remove the microinverter from the PV racking.



**WARNING:** Risk of electric shock. Risk of fire. Do not leave any connectors on the PV system disconnected for an extended period. If you do not plan to replace the microinverter immediately, you must cover any unused connector with a sealing cap.

## Install a Replacement Microinverter

- A. When the replacement microinverter is available, verify that the AC branch circuit breaker is de-energized.
- B. Mount the microinverter bracket side up and under the PV module, away from rain and sun. Allow a minimum of 1.9cm (0.75") between the roof and the microinverter. Also allow 1.3cm (0.50") between the back of the PV module and the top of the microinverter



**WARNING: Risk of equipment damage. Mount the microinverter under the PV module.**

- Install the microinverter under the PV module to avoid direct exposure to rain, UV, and other harmful weather events.
  - Always install the microinverter bracket side up.
  - Do not mount the microinverter upside down.
  - Do not expose the AC or DC connectors (on the Enphase Q Cable connection, PV module, or the microinverter) to rain or condensation before the connectors are mated.
- C. Torque the mounting fasteners to the values shown. **Do not over torque.**
    - 6 mm (1/4") mounting hardware: 5 N m (45 to 50 in-lbs.)
    - 8 mm (5/16") mounting hardware: 9 N m (80 to 85 in-lbs.)
    - When using UL 2703 mounting hardware, use the manufacturer's recommended torque value
  - D. If you are using bonding hardware, the old bonding hardware should be discarded, and new bonding hardware must be used when installing the replacement microinverter.
  - E. Connect the microinverter to the Q Cable connector. Listen for a click as connectors engage.
  - F. Connect the DC leads of each PV module to the DC input connector of the microinverter.
  - G. Re-mount the PV module above the microinverter.
  - H. Energize the AC branch circuit breaker, and verify operation of the replacement microinverter by checking the Status LED on the connector side of the microinverter.
  - I. Use the Installer Toolkit mobile app to delete the old microinverter serial number from the Enphase IQ Envoy database. In Installer Toolkit, once connected to the Envoy:
    - a. Tap **Micros > Manage**.
    - b. Tap the checkbox  to the right of the microinverter serial number that you replaced.
    - c. Tap  to delete the microinverter from the IQ Envoy database.

- J. Add the new microinverter serial number to the Envoy database by initiating a device scan using one of the following methods:
- a. **Method 1: Initiate a scan using the Installer Toolkit mobile app**
    - In Installer Toolkit, once connected to the IQ Envoy, navigate to the Overview screen.
    - From the Overview screen, tap **Detected > Start Device Scan** to start a new 30-minute device scan.
    - If device scanning on the IQ Envoy is inhibited, the app displays **Scan Inhibited**. If you need to add more microinverters to the system when device scanning is inhibited on the IQ Envoy, you must use the Installer Toolkit scanning tool to provision them on the IQ Envoy, rather than using the IQ Envoy's device scanning function to discover them. If this is not possible and you need to enable device scanning on the IQ Envoy, contact Enphase Customer Support at [enphase.com/en-us/support/contact](https://enphase.com/en-us/support/contact).
  - b. **Method 2: Use an IQ Envoy**
    - Press the **Device Scan** button on the IQ Envoy. The IQ Envoy begins a 15-minute scan to identify all of the microinverters deployed at the site. The Microinverter Communications LED  $\leftrightarrow$  flashes green during the scan.

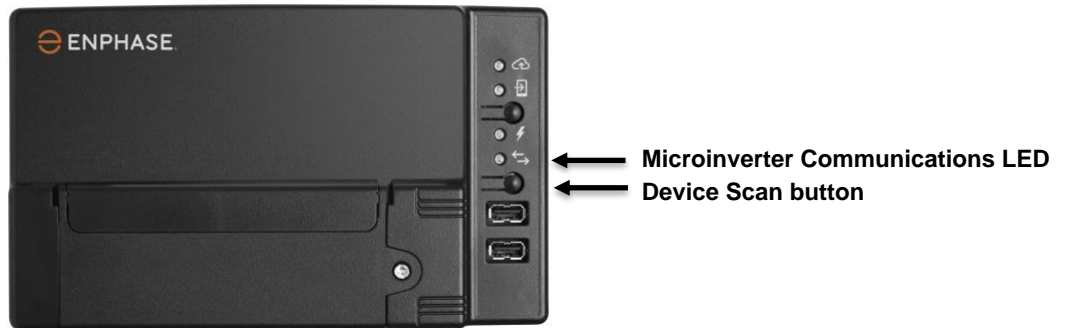

- K. Log in to Enlighten to use Enlighten's Array Builder to add the newly detected microinverter to the virtual array.
- L. Ship the old microinverter to Enphase using the supplied return-shipping label.

## Ordering Replacement Parts

Replacement adaptors for Microinverters **with MC-4 DC** connectors include:

- **Q-DCC-2:** Cable Assembly, DC adaptor to MC-4
- **Q-DCC-5:** Cable Assembly, DC adaptor to Amphenol UTX

These parts are available from your Enphase distributor.

## Enphase Q Cable Planning and Ordering

The Enphase Q Cable is a continuous length of 12 AWG, double insulated, outdoor-rated cable with integrated connectors for microinverters. These connectors are preinstalled along the Q Cable at intervals to accommodate varying PV module widths. The microinverters plug directly into the cable connectors.

The cabling is compatible with a variety of PV racking systems. For a list of approved PV racking systems, refer to the PV Racking Compatibility document on the Enphase website at [enphase.com/support](http://enphase.com/support).

## Connector Spacing Options

Q Cable is available in three connector spacing options. The gap between connectors on the cable can be 1.3 meters, 2.0 meters, or 2.3 meters. The 1.3 meter spacing is best suited for connecting PV modules installed in portrait orientation, while the 2.0 meter and 2.3 meter spacing allows you to install 60-cell and 72-cell PV modules in landscape orientation, respectively.

## Cabling Options

Ordering options include:

Cable Model	Connector spacing	PV module orientation	Connector count per box
Q-12-10-240	1.3m (50")	Portrait	240
Q-12-17-240	2.0m (78")	Landscape (60-cell)	240
Q-12-20-200	2.3m (90")	Landscape (72-cell)	200

The Cabling System is flexible enough to adapt to almost any solar design. To determine the cable type, you need, apply the following considerations:

- When mixing PV modules in both portrait and landscape orientation, you may need to transition between cable types. See the preceding table for available cable types.
- To transition between cable types, install a Field Wireable connector pair.
- In situations where portrait modules are widely spaced, you may need to use landscape spaced cables for the portrait-oriented PV modules and create loops of excess cable, if needed.



**WARNING:** Do not form loops smaller than 12 cm (4.75") in diameter.

## Enphase Q Cable Accessories

The Enphase Q Cable is available with several accessory options for ease of installation, including:

- **Field wireable connectors (male):** (Q-CONN-10M) Make connections from any Field Wireable female connector
- **Field wireable connectors (female):** (Q-CONN-10F) Make connections from any Q Cable open connector or Field Wireable male connector
- **Enphase Q Aggregator:** (Q-BA-3-1P-60) Aggregates up to three fully populated 20A branch circuits and supports solar arrays of up to 11.5kWac with a single rooftop aggregator
- **Cable clips:** (Q-CLIP-100) Used to fasten cabling to the racking or to secure looped cabling
- **Disconnect tool:** (Q-DISC-10) Disconnect tool for Q Cable connectors, DC connectors, and AC module mount
- **Q Cable sealing caps (female):** (Q-SEAL-10) One needed to cover each unused connector on the cabling
- **Terminator:** (Q-TERM-10) Terminator cap for cut cable ends

# Technical Data

## Technical Considerations

Be sure to apply the following when installing the Enphase IQ 7 Series Micro System:



**WARNING:** Risk of equipment damage. You must match the DC operating voltage range of the PV module with the allowable input voltage range of the Enphase Microinverter.



**WARNING:** Risk of equipment damage. The maximum open circuit voltage of the PV module must not exceed the specified maximum input voltage of the Enphase Microinverter.

- PV modules must have conductors labeled "PV Wire" or "PV Cable" to comply with NEC for Ungrounded PV Power Systems.
- Verify that the voltage and current specifications of the PV module match those of the microinverter.
- The maximum short circuit current rating of the PV module must be equal to or less than the maximum input DC short circuit current rating of the microinverter.

The output voltage and current of the PV module depends on the quantity, size and temperature of the PV cells, as well as the insolation on each cell. The highest PV module output voltage occurs when the temperature of the cells is the lowest and the PV module is at open circuit (not operating).

## Specifications

See specifications in the following tables for:

- Enphase IQ7-60-2-US Microinverters
- Enphase IQ7PLUS-72-2-US Microinverters
- Enphase IQ7X-96-2-US Microinverters
- Enphase IQ7A-72-2-US Microinverters
- Enphase Q Cable

### IQ7-60-2-US Microinverter Specifications

Enphase IQ7-60-2-US Microinverter Parameters				
Topic	Unit	Min	Typical	Max
<b>DC Parameters</b>				
Commonly used module pairings <sup>1</sup>		235 W – 350+ W		
Peak power tracking voltage	V	27		37
Operating voltage range	V	16		48
Maximum input DC voltage	V			48
Minimum / maximum start voltage	V	22		48
Maximum DC input short circuit current (module I <sub>sc</sub> )	A			15
Overvoltage class DC port			II	
DC Port backfeed under single fault	A			0
PV array configuration	1x1 ungrounded array; No additional DC side protection required; AC side protection requires max 20A per branch circuit			
<b>AC Parameters</b>				
Maximum continuous AC output power (-40°C to +65°C)	VA	240		
Peak output power	VA	250		
Power factor (adjustable)		0.85 leading 0.85 lagging		
Nominal AC output voltage range <sup>2</sup>				
240 VAC (single phase)	V <sub>rms</sub>	211		264
208 VAC (single phase)	V <sub>rms</sub>	183		229
Nominal output current				
240 VAC (single phase)	A <sub>rms</sub>		1.0	
208 VAC (single phase)	A <sub>rms</sub>		1.15	
Nominal frequency	Hz		60	
Extended frequency range	Hz	47		68
Maximum AC output over current protection device	A	20		
AC short circuit fault current over 3 cycles	A rms for over 3 cycles	5.8 Arms		

<sup>1</sup> No enforced DC/AC ratio. See the compatibility calculator at [enphase.com/en-us/support/module-compatibility](https://enphase.com/en-us/support/module-compatibility)

<sup>2</sup> Nominal Voltage Range can be extended if required by the utility.



Enphase IQ7-60-2-US Microinverter Parameters				
Topic	Unit	Min	Typical	Max
High AC voltage trip limit accuracy	mVrms			280
Low AC voltage trip limit accuracy	mVrms	179		
Frequency trip limit accuracy	%	±0.1		
Trip time accuracy	milliseconds	±0.1% or 2 cycles		
Overvoltage class AC port			III	
AC port backfeed under single fault	A		0	
Power factor setting			1.0	
Miscellaneous Parameters				
Maximum <sup>3</sup> microinverters per 20A (max) AC branch circuit				
240 VAC (single phase)				16
208 VAC (single phase)				13
CEC weighted efficiency	%			
240 VAC (single phase)			97.0	
208 VAC (single phase)			96.5	
Static MPPT efficiency (weighted, ref EN 50530)	%		99.0	
Total harmonic distortion	%			5
Ambient temperature range	°C	-40		+65
Night tare loss	mW			50
Storage temperature range	°C	-40		+85
Features and Specifications				
Compatibility	Pairs with most 60-cell PV modules (the PV module DC conductors must be labeled "PV Wire" or "PV Cable" to be compliant with NEC for Ungrounded PV Power Systems)			
Dimensions not including mounting bracket	212 mm x 175 mm x 30.2 mm (approximate)			
Connector type	IQ7-60-2-US has an MC-4 connector			
Weight	1.08 kg (2.38 lbs.)			
Environmental category / UV exposure rating	NEMA type 6 / outdoor			
Torque specifications for fasteners (Do not over torque)	<ul style="list-style-type: none"> <li>• 6 mm (1/4") mounting hardware: 5 N m (45 to 50 in-lbs.)</li> <li>• 8 mm (5/16") mounting hardware: 9 N m (80 to 85 in-lbs.)</li> <li>• When using UL 2703 mounting hardware, use the manufacturer's recommended torque value</li> </ul>			
Cooling	Natural convection - no fans			
Relative humidity range	4% to 100% condensing			
Approved for wet locations	Yes			
Pollution degree	PD3			

<sup>3</sup> Limits may vary. Refer to local requirements to define the number of microinverters per branch in your area.

Enphase IQ7-60-2-US Microinverter Parameters				
Topic	Unit	Min	Typical	Max
Standard warranty term	<a href="http://enphase.com/warranty">enphase.com/warranty</a>			
Compliance	CA Rule 21 (UL 1741-SA) UL 62109-1, UL1741/IEEE1547, FCC Part 15 Class B, ICES-0003 Class B, CAN/CSA-C22.2 NO. 107.1-01  This product is UL Listed as PV Rapid Shut Down Equipment and conforms with NEC-2014 and NEC-2017 section 690.12 and C22.1-2015 Rule 64-218 Rapid Shutdown of PV Systems, for AC and DC conductors, when installed according manufacturer's instructions.			
Grounding	The DC circuit meets the requirements for ungrounded PV arrays in NEC. Ground fault protection (GFP) is integrated into the class II double insulated microinverter.			
Monitoring	Enlighten Manager and MyEnlighten monitoring options. Both options require an Enphase IQ Envoy			
Communication	Power line communication (PLC)			
Integrated DC disconnect/ Integrated AC disconnect	The DC and AC connectors have been evaluated and approved for use as the load-break disconnect required by NEC 690.			

**IQ7PLUS-72-2-US Microinverter Specifications**

IQ7PLUS-72-2-US Microinverter Parameters				
Topic	Unit	Min	Typical	Max
<b>DC Parameters</b>				
Commonly used module pairings <sup>4</sup>	W	235 W - 440+ W		
Peak power tracking voltage	V	27	36	45
Operating range	V	16		60
Maximum DC input voltage	V			60
Minimum / maximum start voltage	V	22		60
Maximum DC input short circuit current (module I <sub>sc</sub> )	A			15
Overvoltage class DC port			II	
DC Port backfeed under single fault	A			0
PV array configuration	1x1 ungrounded array; No additional DC side protection required; AC side protection requires max 20A per branch circuit			
<b>AC Parameters</b>				
Maximum continuous AC output power (-40 to +65°C)	VA	290		
Peak output power	VA	295		
Power factor (adjustable)		0.85 leading 0.85 lagging		
Nominal AC output voltage ranges 240 VAC (single phase) 208 VAC (single phase)	V <sub>rms</sub> V <sub>rms</sub>	211 183		264 229
Nominal output current 240 VAC (single phase) 208 VAC (single phase)	A <sub>rms</sub> A <sub>rms</sub>		1.21 1.39	
Nominal frequency	Hz		60	
Extended frequency range	Hz	47		68
Maximum AC output over current protection device	A	20		
AC short circuit fault current over 3 cycles	A rms for over 3 cycles	5.8 Arms		
High AC voltage trip limit accuracy	%	±1.0		
Low AC voltage trip limit accuracy	%	±1.0		
Frequency trip limit accuracy	%	±0.1		
Trip time accuracy	milliseconds	±0.1% or 2 cycles		
Overvoltage class AC port			III	
AC port backfeed under single fault	A		0	
Power factor setting			1.0	

<sup>4</sup> No enforced DC/AC ratio. See the compatibility calculator at [enphase.com/en-us/support/module-compatibility](http://enphase.com/en-us/support/module-compatibility)

<sup>5</sup> Nominal Voltage Range can be extended if required by the utility.

IQ7PLUS-72-2-US Microinverter Parameters				
Topic	Unit	Min	Typical	Max
<b>Miscellaneous Parameters</b>				
Maximum <sup>6</sup> microinverters per 20A (max) AC branch circuit				13
240 VAC (single phase)				11
208 VAC (single phase)				
CEC weighted efficiency	%			
240 VAC (single phase)		97.0		
208 VAC (single phase)		96.5		
Static MPPT efficiency (weighted, ref EN 50530)	%	99.0		
Total harmonic distortion	%			5
Ambient temperature range	°C	-40		+65
Night tare loss	mW			50
Storage temperature range	°C	-40		+85
<b>Features and Specifications</b>				
Compatibility	Pairs with most 60 and 72-cell PV modules			
Dimensions not including mounting bracket	212 mm x 175 mm x 30.2 mm (approximate)			
Connector type	IQ7PLUS-72-2-US has an MC-4 connector			
Weight	1.08 kg (2.38 lbs.)			
Environmental category / UV exposure rating	NEMA type 6 / outdoor			
Torque specifications for fasteners (Do not over torque)	<ul style="list-style-type: none"> <li>• 6 mm (1/4") mounting hardware: 5 N m (45 - 50 in-lbs.)</li> <li>• 8 mm (5/16") mounting hardware: 9 N m (80 - 85 in-lbs.)</li> <li>• When using UL 2703 mounting hardware, use the manufacturer's recommended torque value</li> </ul>			
Cooling	Natural convection - no fans			
Relative humidity range	4% to 100% condensing			
Approved for wet locations	Yes			
Pollution degree	PD3			
Communication	Power line communication (PLC)			
Standard warranty term	<a href="http://enphase.com/warranty">enphase.com/warranty</a>			
Compliance	CA Rule 21 (UL 1741-SA) UL 62109-1, UL1741/IEEE1547, FCC Part 15 Class B, ICES-0003 Class B, CAN/CSA-C22.2 NO. 107.1-01 This product is UL Listed as PV Rapid Shut Down Equipment and conforms with NEC-2014 and NEC-2017 section 690.12 and C22.1-2015 Rule 64-218 Rapid Shutdown of PV Systems, for AC and DC conductors, when installed according manufacturer's instructions.			
Grounding	The DC circuit meets the requirements for ungrounded PV arrays in NEC. Ground fault protection (GFP) is integrated into the class II double insulated microinverter.			
Monitoring	Enlighten Manager and MyEnlighten monitoring options. Both options require an Enphase IQ Envoy			
Integrated DC disconnect/ Integrated AC disconnect	The DC and AC connectors have been evaluated and approved for use as the load-break disconnect required by NEC 690.			

<sup>6</sup> Limits may vary. Refer to local requirements to define the number of microinverters per branch in your area.

**IQ7X-96-2-US Microinverter Specifications**

IQ7X-96-2-US Microinverter Parameters				
Topic	Unit	Min	Typical	Max
<b>DC Parameters</b>				
Commonly used module pairings <sup>7</sup>	W	320 W - 460+ W		
Peak power tracking voltage	V	53		64
Operating range	V	25		79.5
Maximum DC input voltage	V			79.5
Minimum / maximum start voltage	V	33		79.5
Maximum DC input short circuit current (module Isc)	A			10
Overvoltage class DC port			II	
DC Port backfeed under single fault	A			0
PV array configuration	1x1 ungrounded array; No additional DC side protection required; AC side protection requires max 20A per branch circuit			
<b>AC Parameters</b>				
Maximum continuous AC output power (-40 to +65°C)	VA	315		
Peak output power	VA	320		
Power factor (adjustable)		0.85 leading 0.85 lagging		
Nominal AC output voltage ranges <sup>8</sup> 240 VAC (single phase) 208 VAC (single phase)	Vrms Vrms	211 183		264 229
Nominal output current 240 VAC (single phase) 208 VAC (single phase)	Arms Arms		1.31 1.51	
Nominal frequency	Hz		60	
Extended frequency range	Hz	47		68
Maximum AC output over current protection device	A	20		
AC short circuit fault current over 3 cycles	A rms for over 3 cycles	5.8 Arms		
High AC voltage trip limit accuracy	%	±1.0		
Low AC voltage trip limit accuracy	%	±1.0		
Frequency trip limit accuracy	%	±0.1		
Trip time accuracy	milliseconds	±0.1% or 2 cycles		
Overvoltage class AC port			III	
AC port backfeed under single fault	A		0	
Power factor setting			1.0	

<sup>7</sup> No enforced DC/AC ratio. See the compatibility calculator at [enphase.com/en-us/support/module-compatibility](https://enphase.com/en-us/support/module-compatibility)

<sup>8</sup> Nominal Voltage Range can be extended if required by the utility.

IQ7X-96-2-US Microinverter Parameters				
Topic	Unit	Min	Typical	Max
<b>Miscellaneous Parameters</b>				
Maximum <sup>9</sup> microinverters per 20A (max) AC branch circuit 240 VAC (single phase) 208 VAC (single phase)				12 10
CEC weighted efficiency 240 VAC (single phase) 208 VAC (single phase)	%	97.5 97.0		
Static MPPT efficiency (weighted, ref EN 50530)	%	99.0		
Total harmonic distortion	%			5
Ambient temperature range	°C	-40		+60
Night tare loss	mW			50
Storage temperature range	°C	-40		+85
<b>Features and Specifications</b>				
Compatibility	Pairs with 96-cell PV modules			
Dimensions not including mounting bracket	212 mm x 175 mm x 30.2 mm (approximate)			
Connector type	IQ7X-96-2-US has an MC-4 connector			
Weight	1.08 kg (2.38 lbs.)			
Environmental category / UV exposure rating	NEMA type 6 / outdoor			
Torque specifications for fasteners (Do not over torque)	<ul style="list-style-type: none"> <li>• 6 mm (1/4") mounting hardware: 5 N m (45 - 50 in-lbs.)</li> <li>• 8 mm (5/16") mounting hardware: 9 N m (80 - 85 in-lbs.)</li> <li>• When using UL 2703 mounting hardware, use the manufacturer's recommended torque value</li> </ul>			
Cooling	Natural convection - no fans			
Relative humidity range	4% to 100% condensing			
Approved for wet locations	Yes			
Pollution degree	PD3			
Communication	Power line communication (PLC)			
Standard warranty term	<a href="http://enphase.com/warranty">enphase.com/warranty</a>			
Compliance	CA Rule 21 (UL 1741-SA) UL 62109-1, UL1741/IEEE1547, FCC Part 15 Class B, ICES-0003 Class B, CAN/CSA-C22.2 NO. 107.1-01 This product is UL Listed as PV Rapid Shut Down Equipment and conforms with NEC-2014 and NEC-2017 section 690.12 and C22.1-2015 Rule 64-218 Rapid Shutdown of PV Systems, for AC and DC conductors, when installed according manufacturer's instructions.			
Grounding	The DC circuit meets the requirements for ungrounded PV arrays in NEC. Ground fault protection (GFP) is integrated into the class II double insulated microinverter.			
Monitoring	Enlighten Manager and MyEnlighten monitoring options. Both options require an Enphase IQ Envoy			
Integrated DC disconnect/ Integrated AC disconnect	The DC and AC connectors have been evaluated and approved for use as the load-break disconnect required by NEC 690.			

<sup>9</sup> Limits may vary. Refer to local requirements to define the number of microinverters per branch in your area.

**IQ7A-72-2-US Microinverter Specifications**

IQ7A-72-2-US Microinverter Parameters				
Topic	Unit	Min	Typical	Max
<b>DC Parameters</b>				
Commonly used module pairings <sup>10</sup>	W	295 W - 460+ W		
Peak power tracking voltage	V	38		43
Operating range	V	18		58
Maximum DC input voltage	V			58
Minimum / maximum start voltage	V	30		58
Maximum DC input short circuit current (module I <sub>sc</sub> )	A			15
Overvoltage class DC port			II	
DC Port backfeed under single fault	A			0
PV array configuration	1x1 ungrounded array; No additional DC side protection required; AC side protection requires max 20A per branch circuit			
<b>AC Parameters</b>				
Maximum continuous AC output power (-40 to +60°C)	VA	349 VA @ 240 VAC	290 VA @ 208 VAC	
Peak output power	VA	366 VA @ 240 VAC	295 VA @ 208 VAC	
Power factor (adjustable)		0.85 leading 0.85 lagging		
Nominal AC output voltage range <sup>11</sup>				
240 VAC (single phase)	V <sub>rms</sub>	211		264
208 VAC (single phase)	V <sub>rms</sub>	183		229
Nominal output current				
240 VAC (single phase)	A <sub>rms</sub>		1.45	
208 VAC (single phase)	A <sub>rms</sub>		1.39	
Nominal frequency	Hz		60	
Extended frequency range	Hz	47		68
Maximum AC output over current protection device	A	20		
AC short circuit fault current over 3 cycles	A rms for over 3 cycles	5.8 A <sub>rms</sub>		
High AC voltage trip limit accuracy	%	±1.0		
Low AC voltage trip limit accuracy	%	±1.0		
Frequency trip limit accuracy	%	±0.1		
Trip time accuracy	milliseconds	±0.1% or 2 cycles		
Overvoltage class AC port			III	
AC port backfeed under single fault	A		0	
Power factor setting			1.0	

<sup>10</sup> No enforced DC/AC ratio. See the compatibility calculator at [enphase.com/en-us/support/module-compatibility](https://enphase.com/en-us/support/module-compatibility)

<sup>11</sup> Nominal Voltage Range can be extended if required by the utility.

IQ7A-72-2-US Microinverter Parameters				
Topic	Unit	Min	Typical	Max
<b>Miscellaneous Parameters</b>				
Maximum <sup>12</sup> microinverters per 20A (max) AC branch circuit				11
240 VAC (single phase)				11
208 VAC (single phase)				11
CEC weighted efficiency	%			
240 VAC (single phase)		97.0		
208 VAC (single phase)		96.5		
Static MPPT efficiency (weighted, ref EN 50530)	%	99.0		
Total harmonic distortion	%			5
Ambient temperature range	°C	-40		+60
Night tare loss	mW			60
Storage temperature range	°C	-40		+85
<b>Features and Specifications</b>				
Compatibility	Pairs with most 60 and 72-cell PV modules			
Dimensions not including mounting bracket	212 mm x 175 mm x 30.2 mm (approximate)			
Connector type	MC-4 connector			
Weight	1.08 kg (2.38 lbs.)			
Environmental category / UV exposure rating	NEMA type 6 / outdoor			
Torque specifications for fasteners (Do not over torque)	<ul style="list-style-type: none"> <li>• 6 mm (1/4") mounting hardware: 5 N m (45 - 50 in-lbs.)</li> <li>• 8 mm (5/16") mounting hardware: 9 N m (80 - 85 in-lbs.)</li> <li>• When using UL 2703 mounting hardware, use the manufacturer's recommended torque value</li> </ul>			
Cooling	Natural convection - no fans			
Relative humidity range	4% to 100% condensing			
Approved for wet locations	Yes			
Pollution degree	PD3			
Communication	Power line communication (PLC)			
Standard warranty term	<a href="http://enphase.com/warranty">enphase.com/warranty</a>			
Compliance	CA Rule 21 (UL 1741-SA) UL 62109-1, UL1741/IEEE1547, FCC Part 15 Class B, ICES-0003 Class B, CAN/CSA-C22.2 NO. 107.1-01 This product is UL Listed as PV Rapid Shut Down Equipment and conforms with NEC-2014 and NEC-2017 section 690.12 and C22.1-2015 Rule 64-218 Rapid Shutdown of PV Systems, for AC and DC conductors, when installed according manufacturer's instructions.			
Grounding	The DC circuit meets the requirements for ungrounded PV arrays in NEC. Ground fault protection (GFP) is integrated into the class II double insulated microinverter.			
Monitoring	Enlighten Manager and MyEnlighten monitoring options. Both options require an Enphase IQ Envoy			
Integrated DC disconnect/ Integrated AC disconnect	The DC and AC connectors have been evaluated and approved for use as the load-break disconnect required by NEC 690.			

<sup>12</sup> Limits may vary. Refer to local requirements to define the number of microinverters per branch in your area.



## Q Cable Specifications

Specification	Value
Voltage rating	600V
Voltage withstand test (kV/1min)	AC 3.0
Max DC conductor resistance (20°C) (Ω/km)	5.433
Insulation resistance (20°C)	≥20M (Ω/km)
System temperature range (ambient)	-40°C to +65°C (-40°F to 149°F)
Cable temperature rating	90°C Dry / 90°C Wet
Cable rating	DG
Certification	UL 3003, TC-ER equivalent
Flame test rating	FT4
Cable conductor insulator rating	THHN/THWN-2
Environmental protection rating	IEC 60529 IP67 NEMA 6
UV resistance	720h
Compliance	RoHS, OIL RES I, CE, UV Resistant, combined UL for Canada and United States
Conductor size	12 AWG
Maximum loop size	12 cm (4.75 ")
Flat cable dimensions	6 mm x 9.5 mm (0.2" x 0.37")
Sealing cap dimensions	38.6 mm x 20 mm (1.5" x 0.7")
Cable connector dimensions	20 mm x 1.1 mm x 6.5 mm (0.7" x 0.04" x 0.25")

## Enphase Connector Ratings

Enphase connectors in the following table have a maximum current of 20A, a maximum OCPD of 20 A, and an ambient temperature range of -40° to +79° C (-40° to +174.2° F).

Part Number	Model	Maximum Voltage
840-00387	Q-12-10-240	277 VAC
840-00388	Q-12-17-240	277 VAC
840-00389	Q-12-20-200	277 VAC
840-00385	Q-DCC-2	100 VDC
840-00386	Q-DCC-5	100 VDC

# Enphase Installation Map

To Sheet / A la hoja de:

Panel Group/Grupo de los paneles: Azimuth/Azimut: Tilt/Inclinación: Sheet/Hoja _____ of/de _____		Customer/Ciente:					Installer/Instalador:		N S E W N S E O
1	2	3	4	5	6	7			
A									
B									
C									
D									
E									
F									
G									
H									
J									
K									
L									
M									

To Sheet / A la hoja de:

Scan completed map and upload it to Enphase. Click "Add a New System" at <https://enlighten.enphaseenergy.com>. Use this map to build the virtual array in Enlighten's Array Builder. /

Escanee el mapa completo y cárguelo en Enphase. Haga clic en "Añadir nuevo sistema" en <https://enlighten.enphaseenergy.com>. Utilice este mapa para crear el conjunto de paneles virtual en el Creador de conjuntos de paneles de Enlighten.

Envoy Serial Number Label /  
Número de serie de Envoy

To Sheet / A la hoja de:

# Sample Wiring Diagram

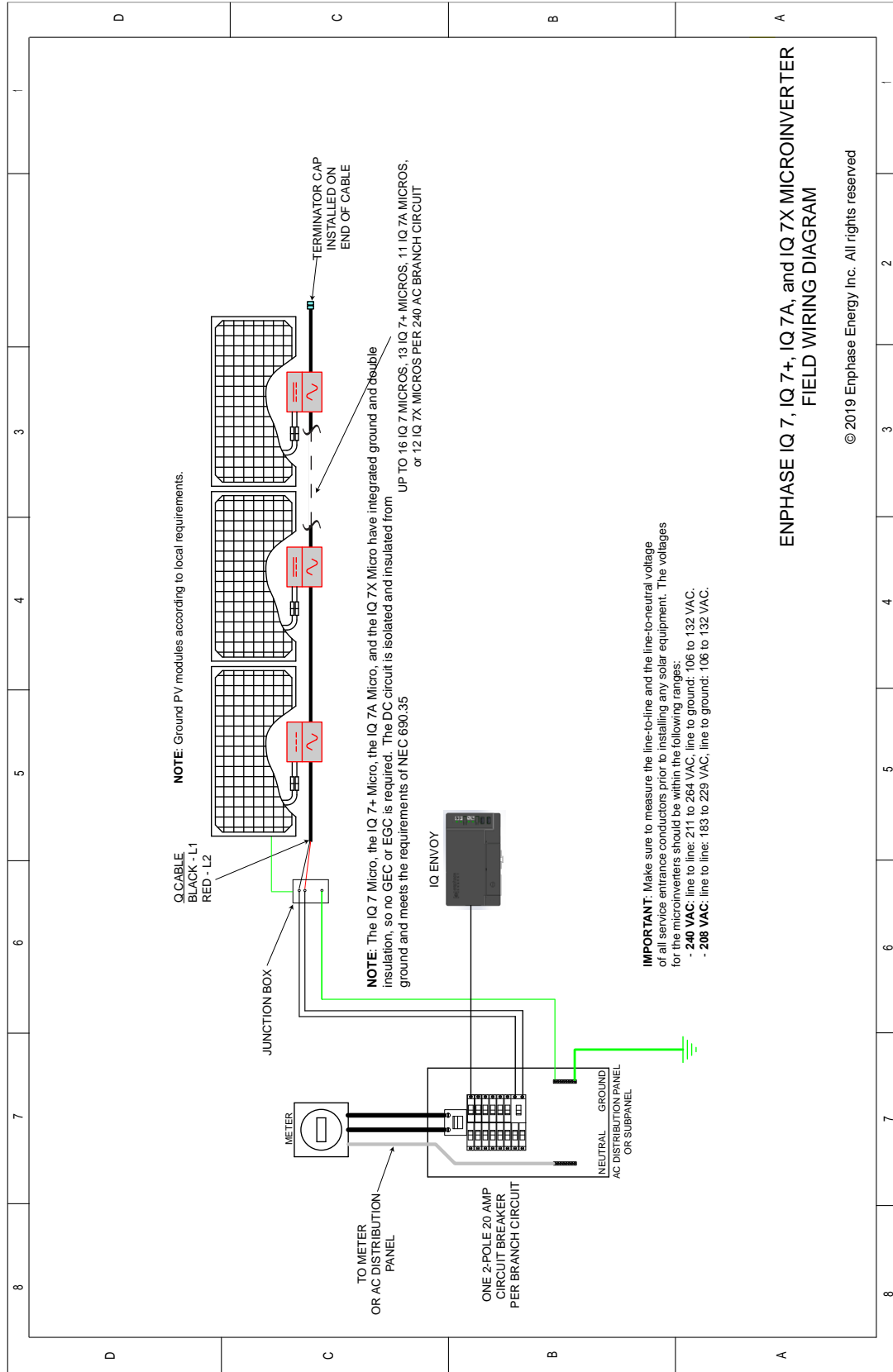

# Rapid shutdown is built-in

The 2014 and 2017 editions of the National Electrical Code (NEC 2014/NEC 2017) added new rapid shutdown requirements for PV systems installed on buildings. Enphase Microinverters fully meet rapid shutdown requirements in the new code without the need to install any additional electrical equipment.

**What's new in Section 690.12?**  
NEC 2014/2017, Section 690.12 applies to PV conductors over 10 feet from the PV array and requires that the conductors power down to 30 volts and 240 volt-amperes within 10 seconds of rapid shutdown initiation.

## String inverters require work arounds for rapid shutdown

**Work around.**

Specialized Rapid Shutdown electrical box installed on the roof within 10 feet of array.

**Work around.**

Shutoff switch that is easily accessible to first responders on the ground.

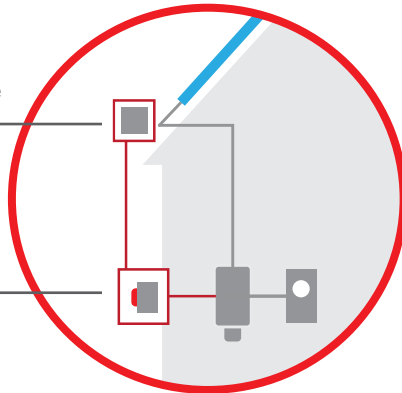

**Residential String Inverter**

**Work around.**

Extra conduit in installation.

**Work around.**

String inverter installed on roof, a hostile environment that string inverters are not built to live in.

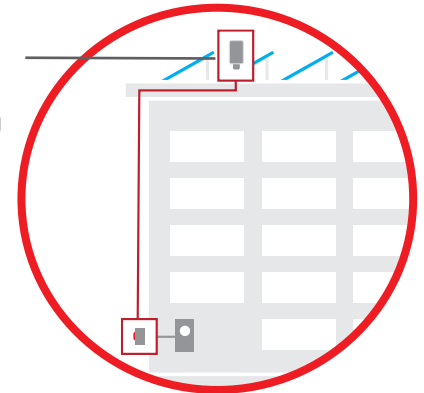

**Commercial String Inverter**

## Enphase comes standard with rapid shutdown capability

All Enphase microinverters, even those that were previously installed, inherently meet rapid shutdown requirements, no additional equipment or workarounds needed

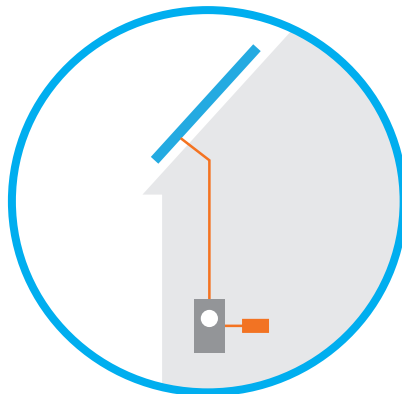

**Residential Microinverter**

Enphase microinverters can safely shut down automatically, leaving only low-voltage DC electricity isolated to the PV module

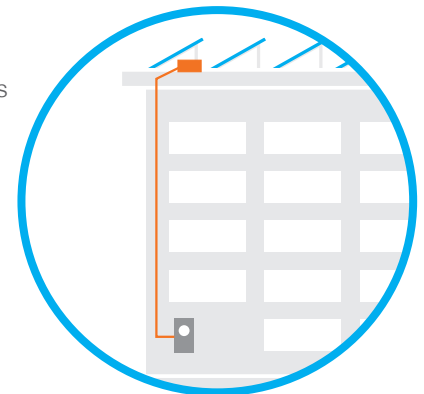

**Commercial Microinverter**

# CERTIFICATE OF COMPLIANCE

**Certificate Number** 20200212-E341165  
**Report Reference** E341165-20171030  
**Issue Date** 2020-FEB-12  
**Issued to:** Enphase Energy Inc.  
1420 N. McDowell Blvd. Petaluma, CA 94954-6515

**This is to certify that  
representative samples of**

Photovoltaic Grid Support Utility Interactive Inverter with Rapid Shutdown  
Functionality

Models IQ7-60, IQ7PLUS-72, IQ7X-96, IQ7XS-96, may be f/b -2, 5 or -E, may be f/b ACM, f/b US+, may be f/b -NM, may be f/b -RMA, may be f/b -&, where "&" designates additional characters.

Models IQ7A, may be f/b S, may be f/b 66 or -72, may be f/b -2, 5, -E, or ACM, f/b -US+, may be f/b -NM, may be f/b -RMA, may be f/b -&, where "&" designates additional characters.

Have been investigated by UL in accordance with the  
Standard(s) indicated on this Certificate.

**Standard(s) for Safety:**

UL 1741, Standard for Safety for Inverters, Converters, Controllers and Interconnection System Equipment for Use With Distributed Energy Resources, UL 1741, Second Edition, dated January 28, 2010. Including the requirements in UL 1741 Supplement SA, sections as noted in the Technical considerations.  
IEEE 1547, IEEE Standard for Interconnecting Distributed Resources with Electric Power Systems.  
IEEE 1547.1, IEEE Standard for Conformance Test Procedures for Equipment Interconnecting Distributed Resources with Electric Power Systems.  
UL 62109-1, Safety of Converters for Use in Photovoltaic Power Systems - Part 1: General Requirements; IEC 62109-2, Safety of Power Converters for use in Photovoltaic Power Systems - Part 2: Particular Requirements for Inverters.  
CSA C22.2 No. 107.1-01, General Use Power Supplies.

**Additional Information:**

See the UL Online Certifications Directory at [www.ul.com/database](http://www.ul.com/database) for additional information

Only those products bearing the UL Certification Mark should be considered as being covered by UL's Certification and Follow-Up Service.

Look for the UL Certification Mark on the product.



Bruce Mahrenholz, Director North American Certification Program

UL LLC

Any information and documentation involving UL Mark services are provided on behalf of UL LLC (UL) or any authorized licensee of UL. For questions, please contact a local UL Customer Service Representative at <http://ul.com/aboutul/locations/>



# CERTIFICATE OF COMPLIANCE

**Certificate Number** 20200212-E341165  
**Report Reference** E341165-20171030  
**Issue Date** 2020-FEB-12

This is to certify that representative samples of the product as specified on this certificate were tested according to the current UL requirements.

**Standards for Safety:**

UL 1741, Standard for Safety for Inverters, Converters, Controllers and Interconnection System Equipment for Use With Distributed Energy Resources, UL 1741, Second Edition, dated January 28, 2010. Including the requirements in UL 1741 Supplement SA, sections as noted in the Technical considerations.

IEEE 1547, IEEE Standard for Interconnecting Distributed Resources with Electric Power Systems.  
IEEE 1547.1, IEEE Standard for Conformance Test Procedures for Equipment Interconnecting Distributed Resources with Electric Power Systems.

UL 62109-1, Safety of Converters for Use in Photovoltaic Power Systems - Part 1: General Requirements; IEC 62109-2, Safety of Power Converters for use in Photovoltaic Power Systems - Part 2: Particular Requirements for Inverters.

CSA C22.2 No. 107.1-01, General Use Power Supplies.



Bruce Mahrenholz, Director North American Certification Program

UL LLC

Any information and documentation involving UL Mark services are provided on behalf of UL LLC (UL) or any authorized licensee of UL. For questions, please contact a local UL Customer Service Representative at <http://ul.com/aboutul/locations/>





# CERTIFICATE OF COMPLIANCE

**Certificate Number** 20200212-E341165  
**Report Reference** E341165-20171030  
**Issue Date** 2020-FEB-12

Components covered by this certificate provide functionality in compliance with UL 1741 Supplement A (SA) when used in a UL Listed end product which has been evaluated by UL for its intended purpose. Compliance testing was conducted on samples of the products according to the test methods in the following sections of UL 1741 with compliant results:

Certified functions. Cross Reference table – UL 1741 SA to SRD	Source Requirement Document(s)	Test Standard(s) and Section(s)	Report Date
ANTI-ISLANDING PROTECTION - UNINTENTIONAL ISLANDING WITH GRID SUPPORT FUNCTIONS ENABLED	Electric Rule No. 21 Hh.1a	UL 1741 SA 8	2019-09-17
LOW/HIGH VOLTAGE RIDE THROUGH	Electric Rule No. 21 Table Hh.1	UL 1741 SA 9	2017-09-17
LOW/HIGH FREQUENCY RIDE THROUGH	Electric Rule No. 21 Table Hh.2	UL 1741 SA10	2017-09-17
RAMP RATES	Electric Rule No. 21 Table Hh.2k	UL 1741 SA 11	2017-09-17
RECONNECT BY "SOFT START"	Electric Rule No. 21 Hh.2k	UL 1741 SA 11	2017-09-17
SPECIFIED POWER FACTOR	Electric Rule No. 21 Hh.2i	UL 1741 SA 12	2017-09-17
DYNAMIC VOLT/VAR OPERATIONS	Electric Rule No. 21 Hh.2J	UL 1741 SA 13	2017-09-17
FREQUENCY-WATT	Electric Rule No. 21 Hh.2.L	UL 1741 SA 14	2017-09-17
VOLT-WATT	Electric Rule No. 21 Hh.2.m	UL 1741 SA 15	2017-09-17
Disable Permit Service	--	UL 1741 SA 17	2017-09-17
Limit Active Power	--	UL 1741 SA 18	2017-09-17

Testing conducted to the requirements of UL 1741 SA corresponds to the minimum requirements for CA Rule 21, 2015. An enumeration of functions tested, including complete ratings, and available certified settings for the Grid Support functions, are recorded in the appendix to this document. Test data and detailed results of compliance testing are retained in the complete UL Report for this product.

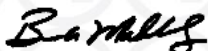

Bruce Mahrenholz, Director North American Certification Program

UL LLC

Any information and documentation involving UL Mark services are provided on behalf of UL LLC (UL) or any authorized licensee of UL. For questions, please contact a local UL Customer Service Representative at <http://ul.com/aboutul/locations/>



# CERTIFICATE OF COMPLIANCE

**Certificate Number** 20200212-E341165  
**Report Reference** E341165-20171030  
**Issue Date** 2020-FEB-12

## Appendix

Detailed Testing Summary	Test Standard(s) and Section(s)	Fixed / Adjustable	Pass / Fail
UNINTENTIONAL ISLANDING WITH GRID SUPPORT FUNCTIONS ENABLED	UL 1741 SA 8	Adjustable	Pass
HIGH VOLTAGE RIDE-THROUGH DURATION	UL 1741 SA 9.1	Adjustable	Pass
HIGH VOLTAGE RIDE-THROUGH / MUST TRIP MAGNITUDES	UL 1741 SA 9.2	Adjustable	Pass
HIGH VOLTAGE MUST TRIP CLEARING TIMES	UL 1741 SA 9.2	Adjustable	Pass
LOW VOLTAGE RIDE-THROUGH DURATION	UL 1741 SA 9.1	Adjustable	Pass
LOW VOLTAGE RIDE-THROUGH / MUST TRIP MAGNITUDES	UL 1741 SA 9.2	Adjustable	Pass
LOW VOLTAGE MUST TRIP CLEARING TIMES	UL 1741 SA 9.2	Adjustable	Pass
HIGH FREQUENCY RIDE-THROUGH DURATION	UL 1741 SA10.1	Adjustable	Pass
HIGH FREQUENCY RIDE-THROUGH / MUST TRIP MAGNITUDES	UL 1741 SA10.2	Adjustable	Pass
HIGH FREQUENCY MUST TRIP CLEARING TIMES	UL 1741 SA10.2	Adjustable	Pass
LOW FREQUENCY RIDE-THROUGH DURATION	UL 1741 SA10.1	Adjustable	Pass
LOW FREQUENCY RIDE-THROUGH / MUST TRIP MAGNITUDES	UL 1741 SA10.2	Adjustable	Pass
LOW FREQUENCY MUST TRIP CLEARING TIMES	UL 1741 SA10.2	Adjustable	Pass
NORMAL RAMP RATE	UL 1741 SA 11.2	Adjustable	Pass
"SOFT START" RAMP RATE	UL 1741 SA 11.4	Adjustable	Pass
SPECIFIED POWER FACTOR	UL 1741 SA 12	Adjustable	Pass
VOLT/VAR MODE (Q(V))	UL 1741 SA 13	Adjustable	Pass
FREQUENCY-WATT (FW)	UL 1741 SA 14	Adjustable	Pass
VOLT-WATT (VW)	UL 1741 SA 15	Adjustable	Pass
Disable Permit Service	UL 1741 SA 17	N/A	Pass
Limit Active Power	UL 1741 SA 18	Adjustable	Pass



Bruce Mahrenholz, Director North American Certification Program

UL LLC

Any information and documentation involving UL Mark services are provided on behalf of UL LLC (UL) or any authorized licensee of UL. For questions, please contact a local UL Customer Service Representative at <http://ul.com/aboutul/locations/>





# CERTIFICATE OF COMPLIANCE

**Certificate Number** 20200212-E341165  
**Report Reference** E341165-20171030  
**Issue Date** 2020-FEB-12

Inverter Firmware Version:		
UL 1998 (grid support)	Date	Version/Revision
N/A	09/01/2017	V02.10.00
Yes	12/19/2017	V02.12.00
Yes	06/22/2018	V02.14.02
Yes	12/26/2018	V04.17.01
Yes	8/20/2019	V04.18.02

Inverter Ratings - Output	Model IQ7-60	
	Single phase	Split phase
Output phase configuration	Single phase	Split phase
Nominal (line to line) output voltage V ac	208 V	240 V
Operating voltage range V ac	183-229 V	211-264 V
Normal out frequency Hz	47-68 Hz	47-68 Hz
Rated output current (A ac)	1.15 A	1.00 A
Rated output power, (kW)	240 VA	240 VA
Max. Branch Circuit overcurrent protection (A ac)	20 A	20 A
Maximum Air Ambient (°C)	65°C	65°C

Inverter Ratings - Output	Model IQ7Plus-72	
	Single phase	Split phase
Output phase configuration	Single phase	Split phase
Nominal (line to line) output voltage V ac	208 V	240 V
Operating voltage range V ac	183-229 V	211-264 V
Normal out frequency Hz	47-68 Hz	47-68 Hz
Rated output current (A ac)	1.42 A	1.23 A
Rated output power, (kW)	290 VA	290 VA
Max. Branch Circuit overcurrent protection (A ac)	20 A	20 A
Maximum Air Ambient (°C)	65°C	65°C

Inverter Ratings - Output	Model IQ7X-96, IQ7XS	
	Single phase	Split phase
Output phase configuration	Single phase	Split phase
Nominal (line to line) output voltage V ac	208 V	240 V
Operating voltage range V ac	183-229 V	211-264 V
Normal out frequency Hz	47-68 Hz	47-68 Hz
Rated output current (A ac)	1.51	1.31
Rated output power, (kW)	0.315	0.315
Max. Branch Circuit overcurrent protection (A ac)	20 A	20 A
Maximum Air Ambient (°C)	60°C	60°C

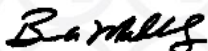

Bruce Mahrenholz, Director North American Certification Program

UL LLC

Any information and documentation involving UL Mark services are provided on behalf of UL LLC (UL) or any authorized licensee of UL. For questions, please contact a local UL Customer Service Representative at <http://ul.com/aboutul/locations/>



# CERTIFICATE OF COMPLIANCE

**Certificate Number** 20200212-E341165  
**Report Reference** E341165-20171030  
**Issue Date** 2020-FEB-12

Inverter Ratings - Output	Model IQ7A, IQ7AS	
Output phase configuration	Single phase	Split phase
Nominal (line to line) output voltage V ac	208 V	240 V
Operating voltage range V ac	183-229 V	211-264 V
Normal out frequency Hz	47-68 Hz	47-68 Hz
Rated output current (A ac)	1.45	1.39
Rated output power, (kW)	0.349	0.290
Max. Branch Circuit overcurrent protection (A ac)	20 A	20 A
Maximum Air Ambient (°C)	60°C	60°C

Inverter Ratings - Output	IQ7PD-72-2-US	
Output phase configuration	Single phase	Split phase
Nominal (line to line) output voltage V ac	208 V	240 V
Operating voltage range V ac	183-229 V	211-264 V
Normal out frequency Hz	47-68 Hz	47-68 Hz
Rated output current (A ac)	0.92	0.80
Rated output power, (kW)	0.190	0.190
Max. Branch Circuit overcurrent protection (A ac)	20 A	20 A
Maximum Air Ambient (°C)	65°C	65°C

Inverter Ratings - Output	IQ7PD-84-2-US	
Output phase configuration	Single phase	Split phase
Nominal (line to line) output voltage V ac	208 V	240 V
Operating voltage range V ac	183-229 V	211-264 V
Normal out frequency Hz	47-68 Hz	47-68 Hz
Rated output current (A ac)	1.06	0.88
Rated output power, (kW)	0.210	0.210
Max. Branch Circuit overcurrent protection (A ac)	20 A	20 A
Maximum Air Ambient (°C)	65°C	65°C

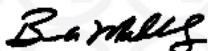

Bruce Mahrenholz, Director North American Certification Program

UL LLC

Any information and documentation involving UL Mark services are provided on behalf of UL LLC (UL) or any authorized licensee of UL. For questions, please contact a local UL Customer Service Representative at <http://ul.com/aboutul/locations/>



# CERTIFICATE OF COMPLIANCE

**Certificate Number** 20200212-E341165  
**Report Reference** E341165-20171030  
**Issue Date** 2020-FEB-12

Other ratings:	
Max. output fault current (A) / duration (ms)	5.8 A rms for 100 ms
Max. utility backfeed current to PV input (A)	0.08 A
Line Synchronization Characteristics / In-rush current	Method 2 / 0.9 A
Limits of accuracy of voltage measurement	+/- 1 % (of Volts nominal)
Limits of accuracy of frequency measurement	+ /- 0.1 Hz
Manufacturers stated accuracy of time response for voltage trips	+/- 2 line cycles or 0.1%
Manufacturers stated accuracy of time response for frequency trips	+/- 2 line cycles or 0.1%
Enclosure Ratings	Type 6

<b>INTERCONNECTION INTEGRITY TEST CATEGORIES:</b>	
C62.42.2 Ring Wave Surge Category	Category B (6kV, 500A)
C62.42.2 Combination Wave Surge Category	Category B (6kV, 3kA)
C37.90.1 RF Immunity - compliance	Yes
C37.90.2 Communication circuit - compliance	N/A

<u>Magnitude and time Limits</u> - Utility interconnection voltage magnitude limits, Ride Through time limits and trip times:						
Nominal voltage	Single / Split phase					
UL 1741 SA9:	Magnitudes (% of nominal)		Ride Through (Seconds) (+)		Must Trip (Seconds)	
Boundary designation (++)	Min	Max	Min	Max	Min	Max
HV3	106 %	122 %	N/A	N/A	0.1	0.5
HV2	104 %	120 %	0.3	19.8	0.5	20.0
HV1	102 %	115 %	0.8	299.8	1.0	300.0
LV1	70 %	98 %	0.3	299.8	0.5	300.0
LV2	50 %	96 %	0.1	149.8	0.2	150.0
LV3	48 %	94 %	0.06	29.8	0.1	30.0



Bruce Mahrenholz, Director North American Certification Program

UL LLC

Any information and documentation involving UL Mark services are provided on behalf of UL LLC (UL) or any authorized licensee of UL. For questions, please contact a local UL Customer Service Representative at <http://ul.com/aboutul/locations/>





# CERTIFICATE OF COMPLIANCE

**Certificate Number** 20200212-E341165  
**Report Reference** E341165-20171030  
**Issue Date** 2020-FEB-12

Magnitude and time Limits - Utility interconnection Frequency magnitude limits, Ride Through time limits and trip times:

Nominal Frequency:	60 Hz					
UL 1741 SA10:	Magnitudes (Frequency)		Ride Through (Seconds) (+)		Must Trip (Seconds)	
Boundary designation	Min	Max	Min	Max	Min	Max
HF3	N/A	N/A	N/A	N/A	N/A	N/A
HF2	60.1	65	N/A	N/A	0.1	0.5
HF1	60.1	65	0.3	599.8	0.5	600
LF1	50	59.9	0.3	599.8	0.5	600
LF2	49.9	57.0	N/A	N/A	0.1	0.5
LF3	N/A	N/A	N/A	N/A	N/A	N/A

SA11 Ramp Rate test ratings (RR/SSRR)

Minimum <b>normal</b> ramp-up rate	1.0 %	%Irated/SEC
Maximum <b>normal</b> ramp-up rate	100 %	%Irated/SEC
Minimum <b>soft start</b> ramp-up rate	0.1 %	%Irated /SEC
Maximum <b>soft start</b> ramp-up rate	100 %	%Irated /SEC

SA12 SPF Specified Power Factor (INV3)

Minimum Inductive (Underexcited) Power Factor (<0)	- 0.85
Minimum Capacitive (Overexcited) Power Factor (>0)	+ 0.85



Bruce Mahrenholz, Director North American Certification Program

UL LLC

Any information and documentation involving UL Mark services are provided on behalf of UL LLC (UL) or any authorized licensee of UL. For questions, please contact a local UL Customer Service Representative at <http://ul.com/aboutul/locations/>



# CERTIFICATE OF COMPLIANCE

**Certificate Number** 20200212-E341165  
**Report Reference** E341165-20171030  
**Issue Date** 2020-FEB-12

SA13 Volt/Var Mode (VV) extent of curve range settings
--

Units operating at 208V:

Settings		Qmax Values - Maximums	Qmin Values - Minimums	Units
Reactive power production setting	Q <sub>1</sub>	154	0.00	VAR
Reactive power absorption setting at the left edge of the deadband	Q <sub>2</sub>	154	-154	VAR
Reactive power absorption setting at the right edge of the deadband	Q <sub>3</sub>	154	-154	VAR
Reactive power absorption setting	Q <sub>4</sub>	0.00	-154	VAR

Functional in the following priority modes:  active power  reactive power

Units operating at 240V:

Settings		Qmax Values - Maximums	Qmin Values - Minimums	Units
Reactive power production setting	Q <sub>1</sub>	185	0.00	VAR
Reactive power absorption setting at the left edge of the deadband	Q <sub>2</sub>	185	-185	VAR
Reactive power absorption setting at the right edge of the deadband	Q <sub>3</sub>	185	-185	VAR
Reactive power absorption setting	Q <sub>4</sub>	0.00	-185	VAR

Functional in the following priority modes:  active power  reactive power

Settings		Maximum	Minimum	Units
The voltage at Q <sub>1</sub>	V <sub>1</sub>	97 %	80 %	%Vnom
The voltage at Q <sub>2</sub>	V <sub>2</sub>	99 %	90 %	%Vnom
The voltage at Q <sub>3</sub>	V <sub>3</sub>	110 %	101 %	%Vnom
The voltage at Q <sub>4</sub>	V <sub>4</sub>	119 %	103 %	%Vnom



Bruce Mahrenholz, Director North American Certification Program  
UL LLC

Any information and documentation involving UL Mark services are provided on behalf of UL LLC (UL) or any authorized licensee of UL. For questions, please contact a local UL Customer Service Representative at <http://ul.com/aboutul/locations/>



# CERTIFICATE OF COMPLIANCE

**Certificate Number** 20200212-E341165  
**Report Reference** E341165-20171030  
**Issue Date** 2020-FEB-12

SA14 Frequency-Watt (FW) extent of curve range settings				
Settings	Frequency		Power level	
	Low end of the adjustment range of the start of the curtailment function	F <sub>start_min</sub>	60.1	100 %
High end of the adjustment range of the start of the curtailment function	F <sub>start_max</sub>	62.0	100 %	%Watts
Low end of the adjustment range of the endpoint of the curtailment function	F <sub>stop_min</sub>	62.5	0 %	%Watts
High end of the adjustment range of the endpoint of the curtailment function	F <sub>stop_max</sub>	65.0	0 %	%Watts

SA15 Volt-Watt (VW) extent of curve range settings				
Settings	Volts		Power level	
	Low end of the adjustment range of the start of the curtailment function	V <sub>start_min</sub>	101 %	100%
High end of the adjustment range of the start of the curtailment function	V <sub>start_max</sub>	108 %	100 %	%Watts
Low end of the adjustment range of the endpoint of the curtailment function	V <sub>stop_min</sub>	103%	0 %	%Watts
High end of the adjustment range of the endpoint of the curtailment function	V <sub>stop_max</sub>	115 %	0 %	%Watts



Bruce Mahrenholz, Director North American Certification Program

UL LLC

Any information and documentation involving UL Mark services are provided on behalf of UL LLC (UL) or any authorized licensee of UL. For questions, please contact a local UL Customer Service Representative at <http://ul.com/aboutul/locations/>

