

## Eaton general duty cartridge fuse safety switch

DG222NRB

UPC:782113144221

### Dimensions:

- **Height:** 14.37 IN
- **Length:** 7.35 IN
- **Width:** 8.4 IN

**Weight:** 10 LB

**Notes:** Maximum hp ratings apply only when dual element fuses are used. 3-Phase hp rating shown is a grounded B phase rating, UL listed.

### Warranties:

- Eaton Selling Policy 25-000, one (1) year from the date of installation of the Product or eighteen (18) months from the date of shipment of the Product, whichever occurs first.

### Specifications:

- **Type:** General duty, cartridge fused
- **Amperage Rating:** 60A
- **Enclosure:** NEMA 3R
- **Enclosure Material:** Painted galvanized steel
- **Fuse Class Provision:** Class H fuses
- **Fuse Configuration:** Fusible with neutral
- **Number Of Poles:** Two-pole
- **Number Of Wires:** Three-wire
- **Product Category:** General duty safety switch
- **Voltage Rating:** 240V

### Supporting documents:

- Eatons Volume 2-Commercial Distribution
- Eaton Specification Sheet - DG222NRB

### Certifications:

- UL Listed

**Product compliance:** No Data

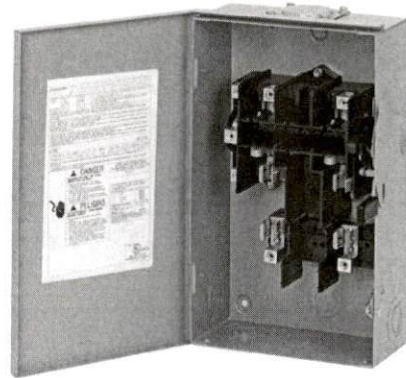



# SunPower® InvisiMount™ | Residential Mounting System

## InvisiMount Component Images

Module\* / Mid Clamp and Rail

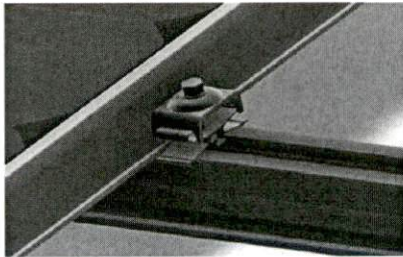

Module\* / End Clamp and Rail

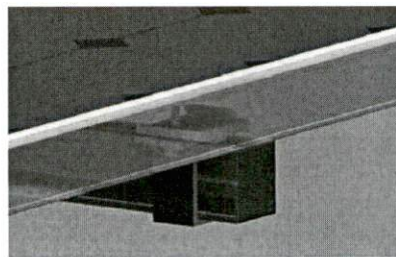

Mid Clamp



End Clamp



Rail & Rail Splice

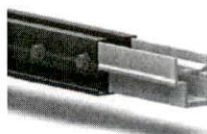

Ground Lug Assembly



End Cap



InvisiMount Component Details		
Component	Material	Weight
Mid Clamp	Black oxide stainless steel AISI 304	63 g (2.2 oz)
End Clamp	Black anodized aluminum alloy 6063-T6	110 g (3.88 oz)
Rail	Black anodized aluminum alloy 6005-T6	830 g/m (9 oz/ft)
Rail Splice	Aluminum alloy 6005-T5	830 g/m (9 oz/ft)
Ground Lug Assembly	304 stainless (A2-70 bolt; tin-plated copper lug)	106.5 g/m (3.75 oz)
End Cap	Black acetal (POM) copolymer	10.4 g (0.37 oz)

InvisiMount Operating Conditions	
Temperature	-40° C to 90° C (-40° F to 194° F)
Max. Load	2400 Pa uplift 5400 Pa downforce

InvisiMount Warranties And Certifications	
Warranties	25-year product warranty 5-year finish warranty
Certifications	UL 2703 Listed Class A fire rating when distance between roof surface and bottom of SunPower module frame is ≤ 3.5"

Roof Attachment Hardware Supported by InvisiMount System Design Tool	
Application	<ul style="list-style-type: none"> <li>• Composition Shingle Rafter Attachment</li> <li>• Composition Shingle Roof Decking Attachment</li> <li>• Curved and Flat Tile Roof Attachment</li> <li>• Universal Interface for Other Roof Attachments</li> </ul>

Roof Attachment Hardware Warranties	
Refer to roof attachment hardware manufacturer's documentation	

\*Module frame that is compatible with the InvisiMount system required for hardware interoperability.

© 2015 SunPower Corporation. All Rights Reserved. SUNPOWER, the SUNPOWER logo, and INVISIMOUNT are trademarks or registered trademarks of SunPower Corporation. All other trademarks are the property of their respective owners. Specifications included in this datasheet are subject to change without notice.

sunpower.com  
Document #509506 Rev B



## SunPower® InvisiMount™ | Residential Mounting System

### Simple and Fast Installation

- Integrated module-to-rail grounding
- Pre-assembled mid and end clamps
- Levitating mid clamp for easy placement
- Mid clamp width facilitates even module spacing
- Simple, pre-drilled rail splice
- UL 2703 Listed integrated grounding

### Flexible Design

- Addresses nearly all sloped residential roofs
- Design in landscape and portrait
- Rails enable easy obstacle management

### Customer-Preferred Aesthetics

- #1 module and #1 mounting aesthetics
- Best-in-class system aesthetics
- Premium, low-profile design
- Black anodized components
- Hidden mid clamps and end clamps hardware, and capped, flush rails

### Part of Superior System

- Built for use with SunPower DC and AC modules
- Best-in-class system reliability and aesthetics
- Combine with SunPower modules and monitoring app

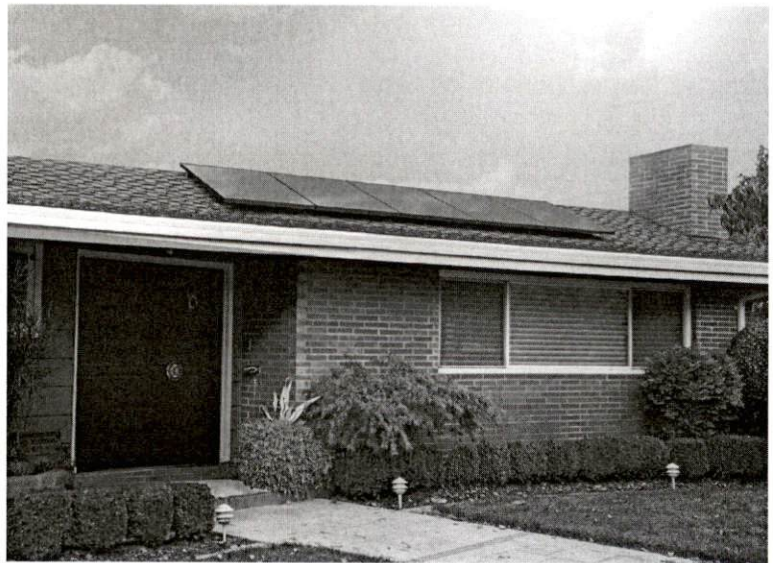

### Elegant Simplicity

SunPower® InvisiMount™ is a SunPower-designed rail-based mounting system. The InvisiMount system addresses residential sloped roofs and combines faster installation time, design flexibility, and superior aesthetics. The InvisiMount product was specifically envisioned and engineered to pair with SunPower modules. The resulting system-level approach will amplify the aesthetic and installation benefits for both homeowners and installers.

[sunpower.com](http://sunpower.com)



SUNPOWER®

## Enphase IQ 7A Microinverter

INPUT (DC)		IQ7A-72-2-US	
Commonly used module pairings <sup>1</sup>	295 W–460 W +		
Module compatibility	60-cell, 66-cell, and 72-cell PV modules		
Maximum input DC voltage	58 V		
Power point tracking voltage range <sup>2</sup>	18 V–58 V		
Min/Max start voltage	33 V / 58 V		
Max DC short circuit current (module I <sub>sc</sub> ) <sup>3</sup>	15 A		
Overvoltage class DC port	II		
DC port backfeed current	0 A		
PV array configuration	1 x 1 ungrounded array; No additional DC side protection required; AC side protection requires max 20A per branch circuit		
OUTPUT (AC)		@ 240 VAC	@ 208 VAC
Peak output power	366 VA	295 VA	
Maximum continuous output power	349 VA	290 VA	
Nominal (L-L) voltage/range <sup>4</sup>	240 V / 211–264 V	208 V / 183–229 V	
Maximum continuous output current	1.45 A (240 VAC)	1.39 A (208 VAC)	
Nominal frequency	60 Hz		
Extended frequency range	47–68 Hz		
AC short circuit fault current over 3 cycles	5.8 Arms		
Maximum units per 20 A (L-L) branch circuit <sup>5</sup>	11 (240 VAC)	11 (208 VAC)	
Overvoltage class AC port	III		
AC port backfeed current	18 mA		
Power factor setting	1.0		
Power factor (adjustable)	0.85 leading ... 0.85 lagging		
EFFICIENCY		@240 VAC	@208 VAC
CEC weighted efficiency	97.0 %		96.5%
MECHANICAL			
Ambient temperature range	-40°C to +60°C		
Relative humidity range	4% to 100% (condensing)		
Connector type: DC (IQ7A-72-2-US)	MC4		
Dimensions (HxWxD)	212 mm x 175 mm x 30.2 mm (without bracket)		
Weight	1.08 kg (2.38 lbs)		
Cooling	Natural convection – No fans		
Approved for wet locations	Yes		
Pollution degree	PD3		
Enclosure	Class II double-insulated, corrosion resistant polymeric enclosure		
Environmental category / UV exposure rating	NEMA Type 6 / outdoor		
FEATURES			
Communication	Power Line Communication (PLC)		
Monitoring	Enlighten Manager and MyEnlighten monitoring options Compatible with Enphase IQ Envoy		
Disconnecting means	The AC and DC connectors have been evaluated and approved by UL for use as the load-break disconnect required by NEC 690.		
Compliance	CA Rule 21 (UL 1741-SA) UL 62109-1, UL1741/IEEE1547, FCC Part 15 Class B, ICES-0003 Class B, CAN/CSA-C22.2 NO. 107.1-01 This product is UL Listed as PV Rapid Shut Down Equipment and conforms with NEC-2014 and NEC-2017 section 690.12 and C22.1-2015 Rule 64-218 Rapid Shutdown of PV Systems, for AC and DC conductors, when installed according manufacturer's instructions.		

1. No enforced DC/AC ratio. See the compatibility calculator at <https://enphase.com/en-us/support/module-compatibility>.

2. CEC peak power tracking voltage range is 38 V to 43 V.

3. Maximum continuous input DC current is 10.2A.

4. Voltage range can be extended beyond nominal if required by the utility.

5. Limits may vary. Refer to local requirements to define the number of microinverters per branch in your area.

To learn more about Enphase offerings, visit [enphase.com](https://enphase.com)

# Enphase IQ 7A Microinverter

The high-powered smart grid-ready Enphase IQ 7A Micro™ dramatically simplifies the installation process while achieving the highest system efficiency for systems with 60-cell and 72-cell modules.

Part of the Enphase IQ System, the IQ 7A Micro integrates with the Enphase IQ Envoy™, Enphase IQ Battery™, and the Enphase Enlighten™ monitoring and analysis software.

The IQ Series Microinverters extend the reliability standards set forth by previous generations and undergo over a million hours of power-on testing, enabling Enphase to provide an industry-leading warranty of up to 25 years.



## High Power

- Peak output power 366 VA @ 240 VAC and 295 VA @ 208 VAC

## Easy to Install

- Lightweight and simple
- Faster installation with improved, lighter two-wire cabling
- Built-in rapid shutdown compliant (NEC 2014 & 2017)

## Efficient and Reliable

- Optimized for high powered 60-cell and 72-cell modules
- Highest CEC efficiency of 97%
- More than a million hours of testing
- Class II double-insulated enclosure
- UL listed

## Smart Grid Ready

- Complies with advanced grid support, voltage and frequency ride-through requirements
- Envoy and Internet connection required
- Configurable for varying grid profiles
- Meets CA Rule 21 (UL 1741-SA)



To learn more about Enphase offerings, visit [enphase.com](https://enphase.com)



**A-Series: A420 | A415 | A410 | A400 | A390 SunPower® Residential AC Module**

AC Electrical Data	
Inverter Model: Type G / SPWR-A4 (IQ 7AS)	@240 VAC
Peak Output Power	366 VA
Max. Continuous Output Power	349 VA
Nom. (L-L) Voltage/Range <sup>2</sup> (V)	240 / 211-264
Max. Continuous Output Current (A)	1.45
Max. Units per 20 A (L-L) Branch Circuit <sup>3</sup>	11
CEC Weighted Efficiency	97.0%
Nom. Frequency	60 Hz
Extended Frequency Range	47-68 Hz
AC Short Circuit Fault Current Over 3 Cycles	5.8 A rms
Overvoltage Class AC Port	III
AC Port Backfeed Current	18 mA
Power Factor Setting	1.0
Power Factor (adjustable)	0.7 lead. / 0.7 lag.

DC Power Data					
	A420-G-AC	A415-G-AC	A410-G-AC	A400-G-AC	A390-G-AC
Nom. Power <sup>5</sup> (P <sub>nom</sub> ) W	420	415	410	400	390
Power Tol.	+5/-0%				
Module Efficiency	22.5	22.3	22.0	21.5	20.9
Temp. Coef. (Power)	-0.29%/°C				
Shade Tol.	Integrated module-level max. power point tracking				

Tested Operating Conditions	
Operating Temp.	-40°F to +185°F (-40°C to +85°C)
Max. Ambient Temp.	122°F (50°C)
Max. Test Load <sup>7</sup>	Wind: 125 psf, 6000 Pa, 611 kg/m <sup>2</sup> back Snow: 187 psf, 9000 Pa, 917 kg/m <sup>2</sup> front
Design Load	Wind: 75 psf, 3600 Pa, 367 kg/m <sup>2</sup> back Snow: 125 psf, 6000 Pa, 611 kg/m <sup>2</sup> front
Impact Resistance	1 inch (25 mm) diameter hail at 52 mph (23 m/s)

Mechanical Data	
Solar Cells	66 Monocrystalline Maxeon Gen 5
Front Glass	High-transmission tempered glass with anti-reflective coating
Environmental Rating	Outdoor rated
Frame	Class 1 black anodized (highest AAMA rating)
Weight	46.5 lbs (21.1 kg)
Recommended Max. Module Spacing	1.3 in. (33 mm)

- SunPower 415 W, 22.3% efficient, compared to a Conventional Panel on same-sized arrays (260 W, 16% efficient, approx. 1.6 m<sup>2</sup>), 7.9% more energy per watt (based on PVsyst pan files for avg. US climate), 0.5%/yr slower degradation rate (Jordan, et. al. "Robust PV Degradation Methodology and Application." PVSC 2018).
- Based on search of datasheet values from websites of top 10 manufacturers per IHS, as of January 2019.
- #1 rank in "Fraunhofer PV Durability Initiative for Solar Modules: Part 3." PVTech Power Magazine, 2015. Campeau, Z. et al. "SunPower Module Degradation Rate," SunPower white paper, 2013.
- Factory set to 1547a-2014 default settings. CA Rule 21 default settings profile set during commissioning.
- Standard Test Conditions (1000 W/m<sup>2</sup> irradiance, AM 1.5, 25°C). NREL calibration standard: SOMS current, LACCS FF and voltage. All DC voltage is fully contained within the module.
- This product is UL Listed as PVRE and conforms with NEC 2014 and NEC 2017 690.12; and C22.1-2015 Rule 64-218 Rapid Shutdown of PV Systems, for AC and DC conductors; when installed according to manufacturer's instructions.
- Please read the safety and installation instructions for more information regarding load ratings and mounting configurations.

See [www.sunpower.com/facts](http://www.sunpower.com/facts) for more reference information.  
 For more details, see extended datasheet [www.sunpower.com/datasheets](http://www.sunpower.com/datasheets) Specifications included in this datasheet are subject to change without notice.  
 ©2020 SunPower Corporation. All Rights Reserved. SUNPOWER, the SUNPOWER logo, Equinox, and MAXEON are registered trademarks of SunPower Corporation in the U.S. and other countries as well. 1-800-SUNPOWER.

Warranties, Certifications, and Compliance	
Warranties	<ul style="list-style-type: none"> <li>• 25-year limited power warranty</li> <li>• 25-year limited product warranty</li> </ul>
Certifications and Compliance	<ul style="list-style-type: none"> <li>• UL 1703</li> <li>• UL 1741 / IEEE-1547</li> <li>• UL 1741 AC Module (Type 2 fire rated)</li> <li>• UL 62109-1 / IEC 62109-2</li> <li>• FCC Part 15 Class B</li> <li>• ICES-0003 Class B</li> <li>• CAN/CSA-C22.2 NO. 107.1-01</li> <li>• CA Rule 21 (UL 1741 SA)<sup>4</sup> (includes Volt/Var and Reactive Power Priority)</li> <li>• UL Listed PV Rapid Shutdown Equipment<sup>4</sup></li> </ul> <p>Enables installation in accordance with:</p> <ul style="list-style-type: none"> <li>• NEC 690.6 (AC module)</li> <li>• NEC 690.12 Rapid Shutdown (inside and outside the array)</li> <li>• NEC 690.15 AC Connectors, 690.33(A)-(E)(1)</li> </ul> <p>When used with InvisiMount racking and InvisiMount accessories (UL 2703):</p> <ul style="list-style-type: none"> <li>• Module grounding and bonding through InvisiMount</li> <li>• Class A fire rated</li> </ul> <p>When used with AC module Q Cables and accessories (UL 6703 and UL 2238)<sup>6</sup>:</p> <ul style="list-style-type: none"> <li>• Rated for load break disconnect</li> </ul>
PID Test	Potential-induced degradation free

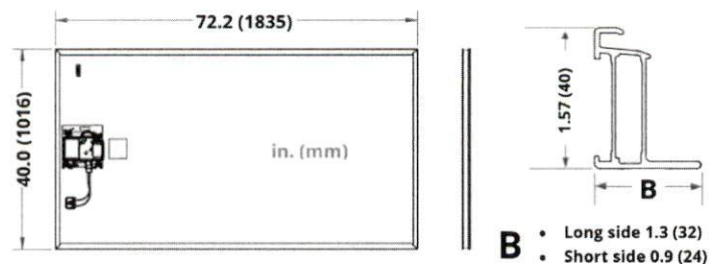

**SUNPOWER®**

Please read the Safety and Installation Instructions 532628 for additional details.

534092 RevB



## 420-390 W Residential AC Module

SunPower® Maxeon® Technology

Built specifically for use with the SunPower Equinox™ system, the only fully integrated solution designed, engineered, and warranted by one manufacturer.

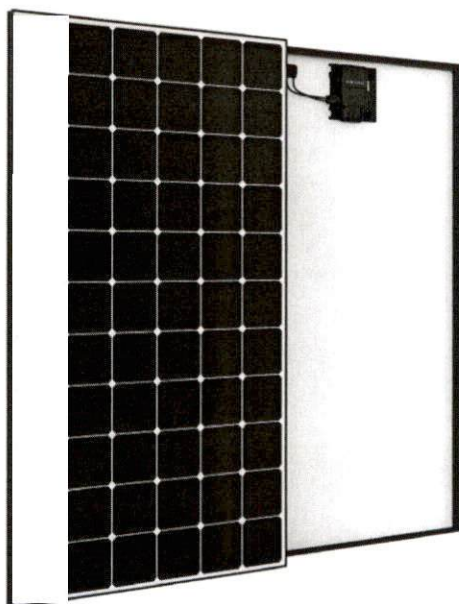

**Fundamentally Different.  
And Better.**

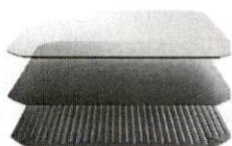

SunPower® Maxeon® Technology

- Most powerful cell in home solar <sup>2</sup>
- Delivers unmatched reliability <sup>3</sup>
- Patented solid metal foundation prevents breakage and corrosion

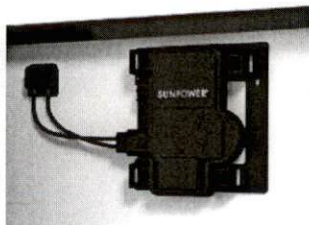

Factory-integrated Microinverter (MI)

- Highest-power integrated AC module in solar
- 60% lighter than prior SunPower MIs
- Engineered and calibrated by SunPower for SunPower AC modules



### Highest Power Density Available.

SunPower's new Maxeon® Gen 5 cell is 65% larger than prior generations, delivering the most powerful cell and highest-efficiency module in residential solar. The result is more power per square meter than any commercially available solar.

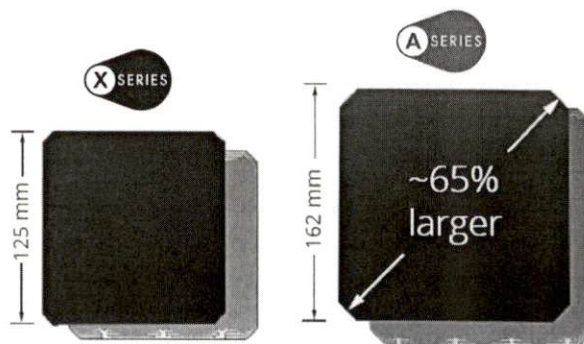

### Highest Lifetime Energy and Savings.

Designed to deliver 60% more energy over 25 years in real-world conditions like partial shade and high temperatures.<sup>1</sup>

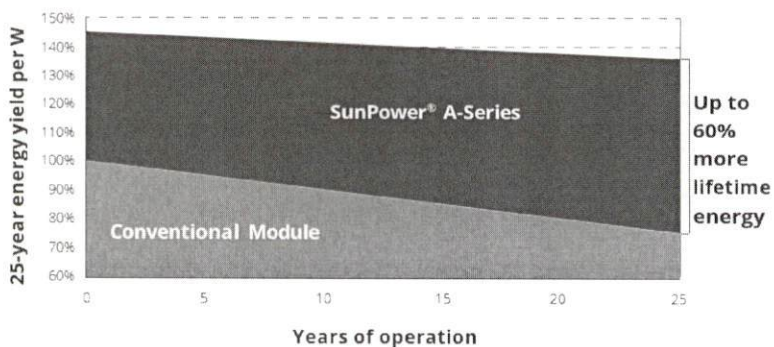

### Best Reliability. Best Warranty.

With more than 25 million modules deployed around the world, SunPower technology is proven to last. That's why we stand behind our module and microinverter with the industry's best 25-year Combined Power and Product Warranty, including the highest Power Warranty in solar.



Roof Structural Assessment

CDR+A Structural Engineers



- **Analysis of Roof Structure A:**
  - Additional dead load 15 psf (12 psf from roof + 3 psf for panels)
  - Roof Live Load - 20 psf. (Allowable Residential Code w/o reductions)
  - The 2x4 SPF trusses spaced 24" apart were analyzed (worst case).
  - Roof Pitch 8.4/12
  - The maximum unbraced span: 7' 4" measured horizontal.
  - Analysis with the additional roof load determined that the roof trusses are 85% stressed. The trusses are in compliance with the current Residential Building Code.
  
- **Analysis of Roof Structure B:**
  - Additional dead load 15 psf (12 psf from roof + 3 psf for panels)
  - Roof Live Load - 20 psf. (Allowable Residential Code w/o reductions)
  - The 2x6 SPF trusses spaced 24" apart were analyzed (worst case).
  - Roof Pitch 15/12
  - The maximum unbraced span: 5' 10" measured horizontal.
  - Analysis with the additional roof load determined that the roof trusses are 41% stressed. The trusses are in compliance with the current Residential Building Code.
  
- **Wind Speed:** Components and cladding 118 mph wind load uplift of -40 psf.
- **Total Wind Load Uplift:** -40 psf x 432 sf = 17,280 lbs total uplift for solar array.
- **Number of Attachment Anchors:** Use a minimum of two (2) bracket per panel (one top and bottom) = 48 total attachment brackets.
- **Wind Load Uplift per Anchor:** 17,280 lbs total uplift / 48 = 360 lbs for solar array.
- **Strength of Hold-down Anchors:** The SunPower InvisiMount is reported to be used with the Pegasus Solar L-Foot. The L-Foot is attached directly into the top of the truss/truss members with a 5/16" stainless steel lag screw with at least 3" of embedment into the wood member. The load testing results determined an average pullout failure load of 556 lbs per screw, exceeding the required 360 lbs per anchor. The loading proposed creates a safety factor of 1.54 or greater for the attachment.

### Conclusions & Recommendations

Based on the information provided, it was determined that the roof truss members were adequate for the addition load of the solar panel array.

The installation of the solar panel array using Pegasus Solar L-Foot attachment bracket lagged directly into the top of the wood truss member is adequate for the loads imposed on them.

### Closure

We appreciate the opportunity to provide structural assessment services to you. Please contact us should you have any questions.

Sincerely,

Roof Assessment for Solar Panel Installation

**CDR+A**

Structural Engineers

**Date:** August 10, 2021  
**Prepared for:** C&S Jin 24p T  
**Project Number:** 210678  
**Assessment Date:** August 9, 2021  
**Site Address:** 12 Hillandale Rd Spring Lake NC 28390  
**Purpose:** Structural Roof Assessment for installation of 24 panel solar array.  
**Prepared by:** Landon Wilson & Clay Medlin, PE, NC #048735  
**NC COL:** C-3298, CDR & Assoc., Inc.



CDR & Assoc., Inc. thanks you for the opportunity to provide you with a letter for the inspection of the roof framing for the installation of solar panel system on the roof of the foresaid property hereafter referred to as "house". All references to directions or locations indicated in this report are by facing the front of the house.

**Observations and Analysis of Roof**

- **Basis of Evaluation:** The engineering analysis is based on measurements and photographs taken onsite by CDR+A technician, Brady Jarvis.
- **Roof Construction:** A layer of asphalt shingles over wood decking on roof truss members.
- **Roof Pitch:** Multiple Slopes
- **Solar Panel Array:** 24 panels.
- **Total Array Square Footage:** The panels are approximately 39.37" x 64.57" or 17.65 sf each, round up to 18 sf x 24 panels = total surface area of 432 sf.
- **Total weight of Array:** Panel weighs approximately 40 lbs. ea. X 24 = 960 lbs. for the Array.
- **Total Additional Weight on Roof:** 960 lbs / 432 sf = 2.22 psf add for rail mount system, assume 3 psf additional load on roof structure.
- **Rail Mount System:** The panels are mounted on aluminum rails at top and bottom of the panels for each row of panels.

PROJECT NAME: JIN, IGNIS

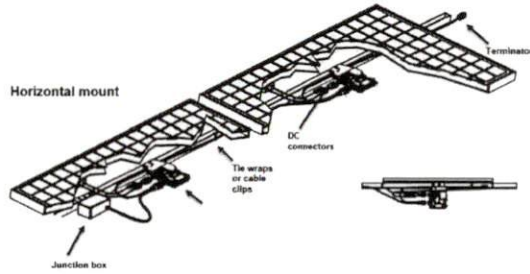

1  
04 MODULE AND MICROINVERTER CONNECTION DETAIL  
NO SCALE



2  
04 SUNPOWER INVISIMOUNT ROOF FLASHING DETAIL  
NO SCALE

SYSTEM AC DISCONNECT AT SERVICE

PHOTOVOLTAIC SYSTEM AC DISCONNECT  
 MAXIMUM OPERATING AC CURRENT: 34.80 AMPS  
 NOMINAL OPERATING AC VOLTAGE: 120/240 VAC

3  
04 PHOTOVOLTAIC MARKING AND LABELING  
NO SCALE

CODE REVIEW & CALCULATIONS

**SOLAR PHOTOVOLTAIC (PV) SYSTEM WITH SUNPOWER**

Inverter Type: Type G (IQ7AS) MicroInverter  
 Minimum String Length: N/A  
 Maximum String Length: 11  
 Nominal String AC Voltage: 240V (AC)  
 Nominal Output Current (Per MicroInverter): 1.45A

**SunPower SPR-A400-G-AC 400W**

**NEC 690.7 MAXIMUM VOLTAGE**

690.7(A): Maximum Photovoltaic System Voltage  
 SPR-A400-G-AC 400W Module  $V_{oc} = 48.10V$   
 Module  $V_{max} = ((-40^{\circ}C) - 25^{\circ}C)(-0.0029/^{\circ}C)(48.10V) + (48.10V) = 57.17V$  (DC)  
 Module  $V_{max}$  Output = 57.17V (DC) < TYPE G (IQ7AS) MAX Input = 80V (DC)

**NEC 690.8 CIRCUIT SIZING AND CURRENT**

690.8(A)(1): Photovoltaic Source Circuit Currents  
 Module to MicroInverter  $I_{max} = 1.45A \times 24 \times 125\% = 43.50A$

690.8(A)(3): Inverter Output Circuit Current.  
 MicroInverter Rated Continuous Output Power = 349W  
 MicroInverter rated Continuous Output Current = 1.45A  
 System  $I_{max} = 43.50A$

**NEC 690.9 OVERCURRENT PROTECTION**

690.9(B): Overcurrent Device Ratings  
 Disconnect Fuse:  $1.45A \times 24 \times 125\% = 43.50A \rightarrow 50A$  OCPD

**NEC 690.12 RAPID SHUTDOWN OF PV SYSTEMS ON BUILDINGS**

PLAN: Rapid Shutdown enabled disconnect shall be located next to the service and be labeled in accordance with 690.56(B) and (C).



**MOXIE**  
 AMERICA'S SOLAR COMPANY

CONTRACTOR

**MOXIE SOLAR**

(855) 669-4387  
 INFO@MOXIESOLAR.COM  
 323 W CHERRY ST  
 NORTH LIBERTY, IA 52317

OWNER

**INGIS JIN**

(929) 391-1130  
 IGNISJIN@GMAIL.COM  
 12 HILLDALE RD  
 SPRING LAKE, NC 28390

A H J

**TOWN OF SPRING LAKE**

(910) 985-1810

300 RUTH ST  
 SPRING LAKE, NC 28390

UTILITY

**SOUTH RIVER ELECTRIC COOP**

(910) 230-2993 EXT. 2152

REVISIONS

08/02/21 PLAN SET CL

DETAILS & CALCULATIONS

04

PROJECT NAME: JIN, IGNIS

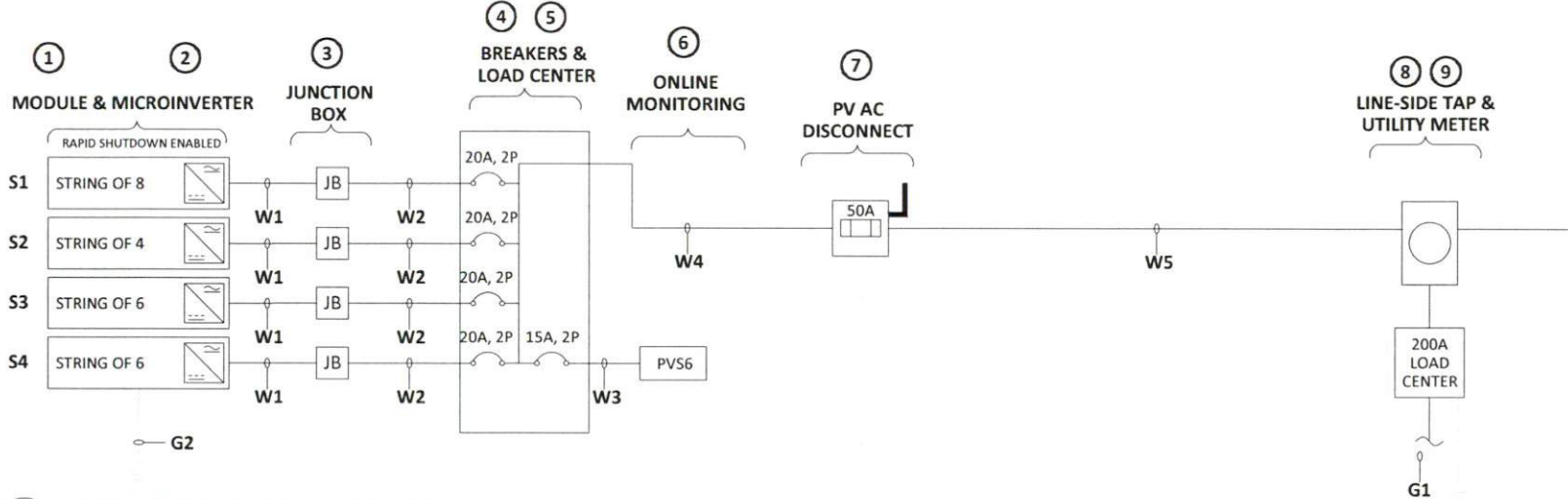

1 ONE-LINE ELECTRICAL DIAGRAM - 9.600 KW (DC)  
03 NO SCALE

EQUIPMENT SCHEDULE						
TAG	ITEM	MAKE	MODEL	VOLTAGE	QTY	LOCATION
1	MODULE	SUNPOWER	SPR-A400-G-AC 400W	DC	24	ROOF TOP
2	MICROINVERTER	SUNPOWER	TYPE G (IQ7XS) 349W (AC)	120/240V, 1Φ	24	ROOF TOP
3	JUNCTION BOX	SUNPOWER	XL-530167	120/240V, 1Φ	4	ROOF TOP
4	BREAKERS	EATON	20A, 2-POLE BR220	120/240V, 1Φ	4	LOAD CENTER
4	BREAKERS	EATON	15A, 2-POLE BR215	120/240V, 1Φ	1	LOAD CENTER
5	LOAD CENTER	EATON	125A ENCLOSURE LUG ONLY BR816L125RP	120/240V, 1Φ	1	BLD EXTERIOR
6	ONLINE MONITORING	SUNPOWER	PV SUPERVISOR 6	120/240V, 1Φ	1	BLD EXTERIOR
7	DISCONNECT	EATON	60A ENCLOSURE 50A FUSED DG222NRB	120/240V, 1Φ	1	BLD EXTERIOR
8	LINE-SIDE TAP	ILSCO	IPC-4/0-6	120/240V, 1Φ	3	UTILITY METER
10	UTILITY METER	ITRON	CL200	120/240V, 1Φ	1	BLD EXTERIOR

WIRE SCHEDULE					
TAG	RUN	CONDUCTOR TYPE	GAUGE	CONDUIT	RUN LENGTH
W1	PV HOMERUNS	Q-CABLE Q-12-10-240-PORT	#12	-	60 FT
W2	JUNCTION BOX TO LOAD CENTER	THWN-2, Cu	#10	¾"	30 FT
W3	LOAD CENTER TO PVS6	THWN-2, Cu	#12	¾"	10 FT
W4	LOAD CENTER TO DISCONNECT	THWN-2, Cu	#8	1"	5 FT
W5	DISCONNECT TO LINE-SIDE TAP	THWN-2, Cu	#8	1"	5 FT
G1	GROUND ELECTRODE	BARE, Cu	#6	-	-
G2	EQUIPMENT GROUND (as per NEC 250.122)	THWN-2, Cu	#10 - #6	-	100 FT

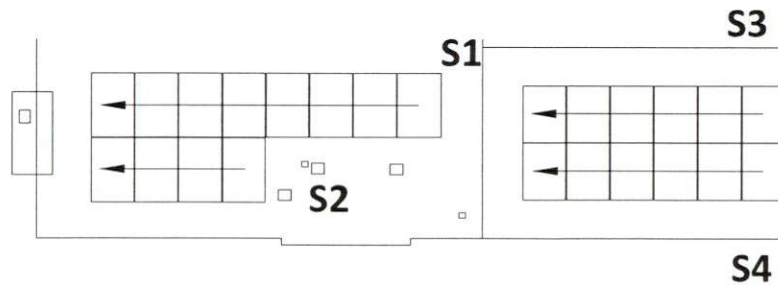

CONTRACTOR

MOXIE SOLAR

(855) 669-4387  
INFO@MOXIESOLAR.COM

323 W CHERRY ST  
NORTH LIBERTY, IA 52317

OWNER

INGIS JIN

(929) 391-1130  
IGNISJIN@GMAIL.COM

12 HILLDALE RD  
SPRING LAKE, NC 28390

A H J

TOWN OF SPRING LAKE

(910) 985-1810

300 RUTH ST  
SPRING LAKE, NC 28390

UTILITY

SOUTH RIVER ELECTRIC COOP

(910) 230-2993 EXT. 2152

REVISIONS

08/02/21 PLAN SET CL

ELECTRICAL

03

# PROJECT NAME: JIN, IGNIS

## BUILD SUMMARY

- **MODULE:** QTY (24) SPR-A400-G-AC 400W, 72.2"x 40"x 1.3" thick, 46.5 lbs
- **STRUCTURE:** Wood prefabricated 2"x 4" trusses @ 24" OC
- **RACKING:** SunPower Invisimount with composite shingle roof flashing. Run rails across the trusses. Penetrate every 4ft or less into trusses. Installer must verify all penetrations are secure and centered in wood members. Any damaged wood members must be repaired immediately by scab, sister, or full replacement. Max Rail Overhang = 19" from last attachment point. Module Overhang = 18"
- **ACCESS:** 2-story residence
- **INVERTERS:** Factory installed microinverters
- **MONITORING:** Online mySunPower Monitoring utilizing existing wireless router
- **ADDITIONAL WORK:** None

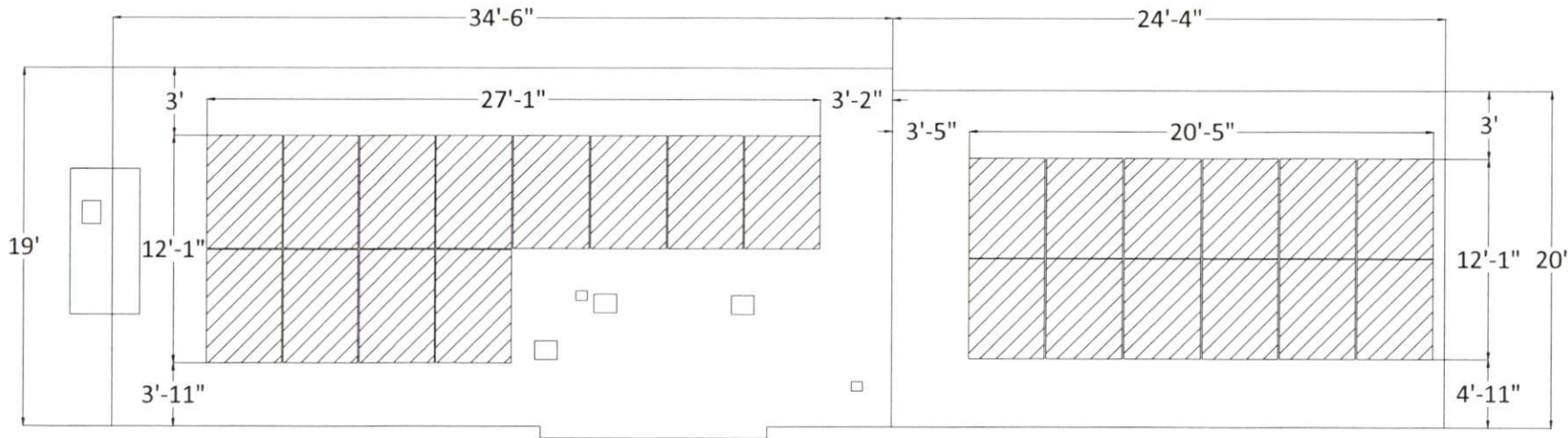

1 ARRAY DESIGN  
02 NO SCALE



**MOXIE**  
AMERICA'S SOLAR COMPANY

## CONTRACTOR

### MOXIE SOLAR

(855) 669-4387  
INFO@MOXIESOLAR.COM  
323 W CHERRY ST  
NORTH LIBERTY, IA 52317

## OWNER

### INGIS JIN

(929) 391-1130  
IGNISJIN@GMAIL.COM  
12 HILLANDALE RD  
SPRING LAKE, NC 28390

## A H J

### TOWN OF SPRING LAKE

(910) 985-1810  
300 RUTH ST  
SPRING LAKE, NC 28390

## UTILITY

**SOUTH RIVER ELECTRIC COOP**  
(910) 230-2993 EXT. 2152

## REVISIONS

08/02/21 PLAN SET CL

## BUILD SUMMARY







02

# PROJECT NAME: JIN, IGNIS

## DESIGN SUMMARY

- **SIZE:** 9.600 kW PV Solar System (24 modules)
- **STYLE:** Residential, asphalt shingle roof, flush mount, grid tied, net-metered
- **LOCATION:** South facing roof of home
- **ORIENTATION:** Portrait, 34°/43° pitch, 135° azimuth
- **MODULE:** SunPower SPR-A400-G-AC 400W, 72.2"x 40"x 1.3" thick, 46.5 lbs
- **RACKING:** SunPower Invisimount with composite shingle roof flashings
- **INVERTER:** SunPower Type G (IQ7AS) Integrated Microinverter
- **VOLTAGE:** 120/240V, 1Φ
- **MONITORING:** Online mySunPower Monitoring
- **ADDITIONAL WORK:** None

THIS DISTRIBUTED GENERATION FACILITY WAS INSTALLED  
IN ACCORDANCE WITH THE CURRENT STATE ADOPTED  
NATIONAL ELECTRICAL CODE

-  **PV Solar Array**  
Roof of building
-  **SunPower Integrated Microinverter**  
Array
-  **PV Solar Dedicated Load Center**  
Building Exterior
-  **AC Solar Disconnect**  
Building Exterior
-  **Utility Meter**  
Building Exterior
-  **Main Service Panel**  
Building Exterior

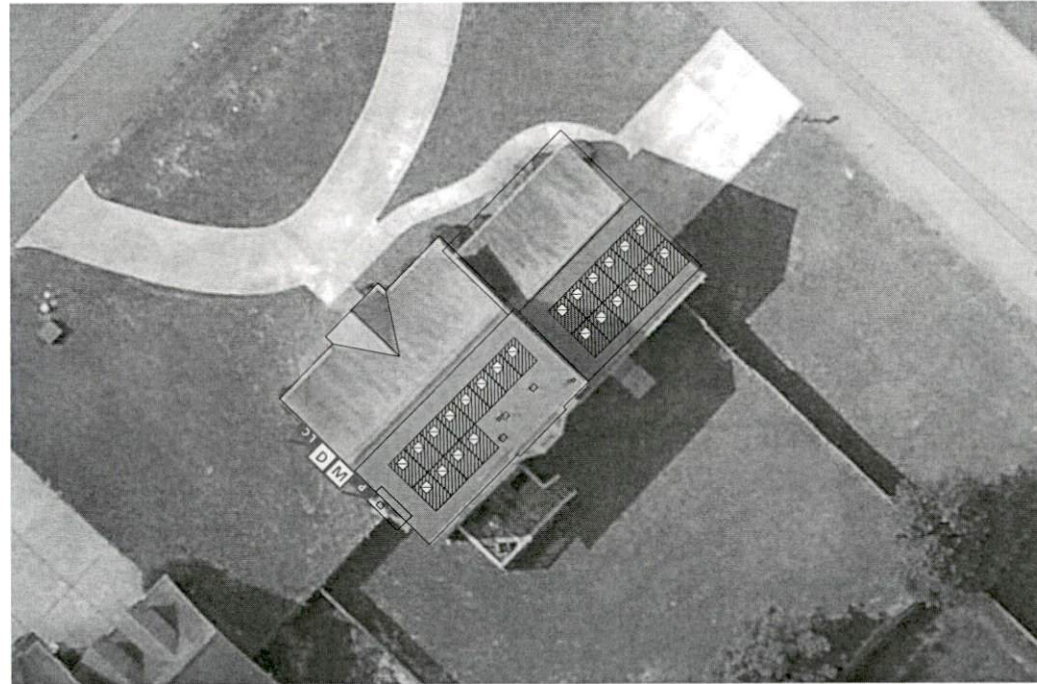

1 SITE MAP  
01 NO SCALE



### CONTRACTOR

#### MOXIE SOLAR

(855) 669-4387  
INFO@MOXIESOLAR.COM  
323 W CHERRY ST  
NORTH LIBERTY, IA 52317

### OWNER

#### INGIS JIN

(929) 391-1130  
IGNISJIN@GMAIL.COM  
12 HILLANDALE RD  
SPRING LAKE, NC 28390

### A H J

#### TOWN OF SPRING LAKE

(910) 985-1810  
300 RUTH ST  
SPRING LAKE, NC 28390

### UTILITY

#### SOUTH RIVER ELECTRIC COOP

(910) 230-2993 EXT. 2152

### REVISIONS

08/02/21 PLAN SET CL

### DESIGN SUMMARY

# 01