

**PROJECT DETAILS**

PV Modules	52 x Q.PEAK DUO BLK G6+ 340
Optimizers	52 x P340
Inverter	1 x SE10000H-US 1 x SE6000H-US
Roof Type	Asphalt Shingles
Racking	IronRidge XR10
Mounting Type	Flashfoot2
DC SIZE	17.68 kW
AC SIZE	16.0 kVA

**DRAWING INDEX**

Item	Drawing #	Rev	Description
1	2185JU00-0	A	Drawing Index
2	2185JU00-1	A	Site Layout
3	2185JU00-2	A	String Mapping
4	2185JU00-3	A	Electrical One Line Diagram
5	2185JU00-4	A	Detailed Electrical Wiring Schematic
6	2185JU00-5	A	PV Labels
7	2185JU00-6	A	Bill of Materials



1600 Heritage Commerce Ct Ste 104,  
Wake Forest NC 27587  
O: 919.948.6474  
E: info@8msolar.com

Jamie Urtz  
128 Canterbury Rd.,  
Sanford NC 27332

**TOP VIEW OF BUILDING**



**FRONT VIEW OF BUILDING**



Item	Date	Rev
1	05/06/2021	A

JOB NUMBER  
21-85-JU00

DATE ISSUED  
05/06/2021

PROJECT STATUS  
PERMITTING

SHEET  
**DRAWING INDEX**

**DRAWING INDEX**  
SCALE: NTS



JU  
2185JU00-0

**PV System Dead Load  
(Panel + Racking weight) / PV System Area**  
 (52 modules x 43.9 lbs./panel + 369 ft. of racking x 1.15 lb.ft) /  
 (52 panels x 68.5" x 40.6") = 2.70 psf

The roof is located in 115mph wind zone

There is one layer of shingles  
 Roofing material is asphalt shingles

Utility  
 Meter



Module  
 Dimension

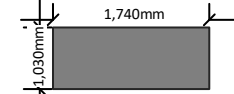

Roofs	Pitch	Azimuth
A	35°	122°
B	35°	122°
C	35°	305°



1600 Heritage Commerce Ct Ste 104,  
 Wake Forest NC 27587  
 O: 919.948.6474  
 E: info@8msolar.com

**SYSTEM DETAILS**

NUMBER OF PANELS : 52  
 PANELS MODEL : Q.PEAK DUO BLK G6+ 340  
 DC SIZE : 17.68 kW  
 AC SIZE : 16.0 kVA

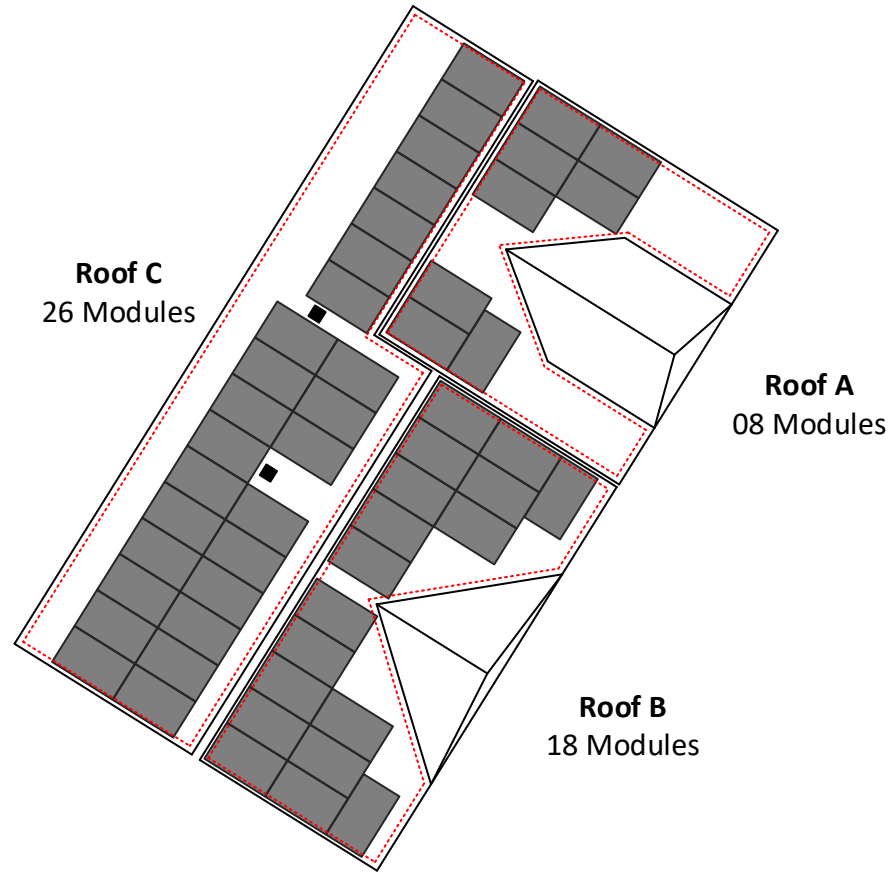

6" clearance  
 from each side  
 of the roof

**Jamie Urtz**  
 128 Canterbury Rd.,  
 Sanford NC 27332



1	05/06/2021	A
—	—	—
—	—	—
—	—	—
—	—	—

JOB NUMBER  
 21-85-JU00  
 DATE ISSUED  
 05/06/2020  
 PROJECT STATUS  
 PERMITTING

SHEET  
**SITE LAYOUT**

JU  
 2185JU00-1

SITE LAYOUT  
 SCALE: 13/200" - 1' 0"



String Layout

Inverter A: SE10000H-US			Inverter B: SE6000H-US		
Strings #	No. of Modules	Color Code	Strings #	No. of Modules	Color Code
String 1	16	Blue	String 3	12	Green
String 2	16	Orange	String 4	08	Purple
		Brown			Light Blue

Utility Meter



Module Dimension

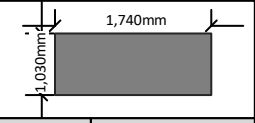

Roofs	Pitch	Azimuth
A	35°	122°
B	35°	122°
C	35°	305°



1600 Heritage Commerce Ct Ste 104,  
Wake Forest NC 27587  
O: 919.948.6474  
E: info@8msolar.com

SYSTEM DETAILS

NUMBER OF PANELS : 52  
 PANELS MODEL : Q.PEAK DUO BLK G6+ 340  
 DC SIZE : 17.68 kW  
 AC SIZE : 16.0 kVA

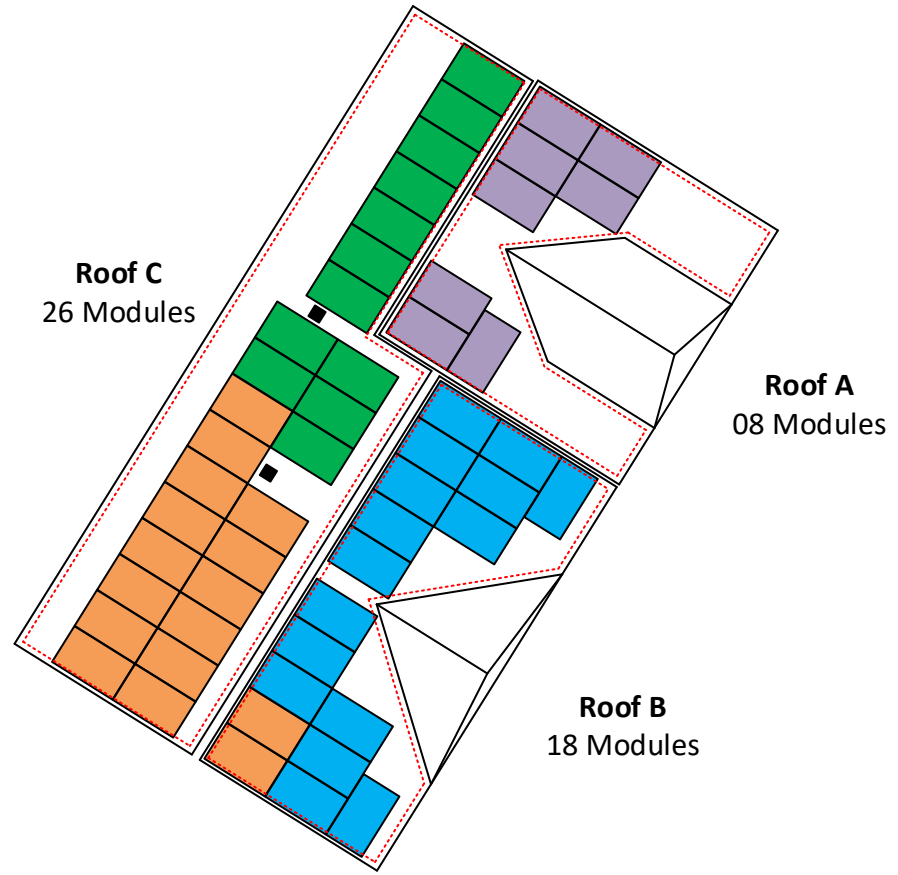

6" clearance  
from each side  
of the roof

Jamie Urtz  
128 Canterbury Rd.,  
Sanford NC 27332



1	05/06/2021	A

JOB NUMBER: 21-85-JU00  
 DATE ISSUED: 05/06/2020  
 PROJECT STATUS: PERMITTING

SHEET  
STRING MAPPING

JU  
2185JU00-2

STRING MAPPING  
SCALE: 13/200" - 1' 0"



Jamie Urtz  
128 Canterbury Rd.,  
Sanford NC 27332



1	05/06/2021	A

JOB NUMBER  
21-85-JU00  
DATE ISSUED  
05/06/2021  
PROJECT STATUS  
PERMITTING

SHEET  
**ELECTRICAL ONE LINE  
DIAGRAM**

JU  
2185JU00-3

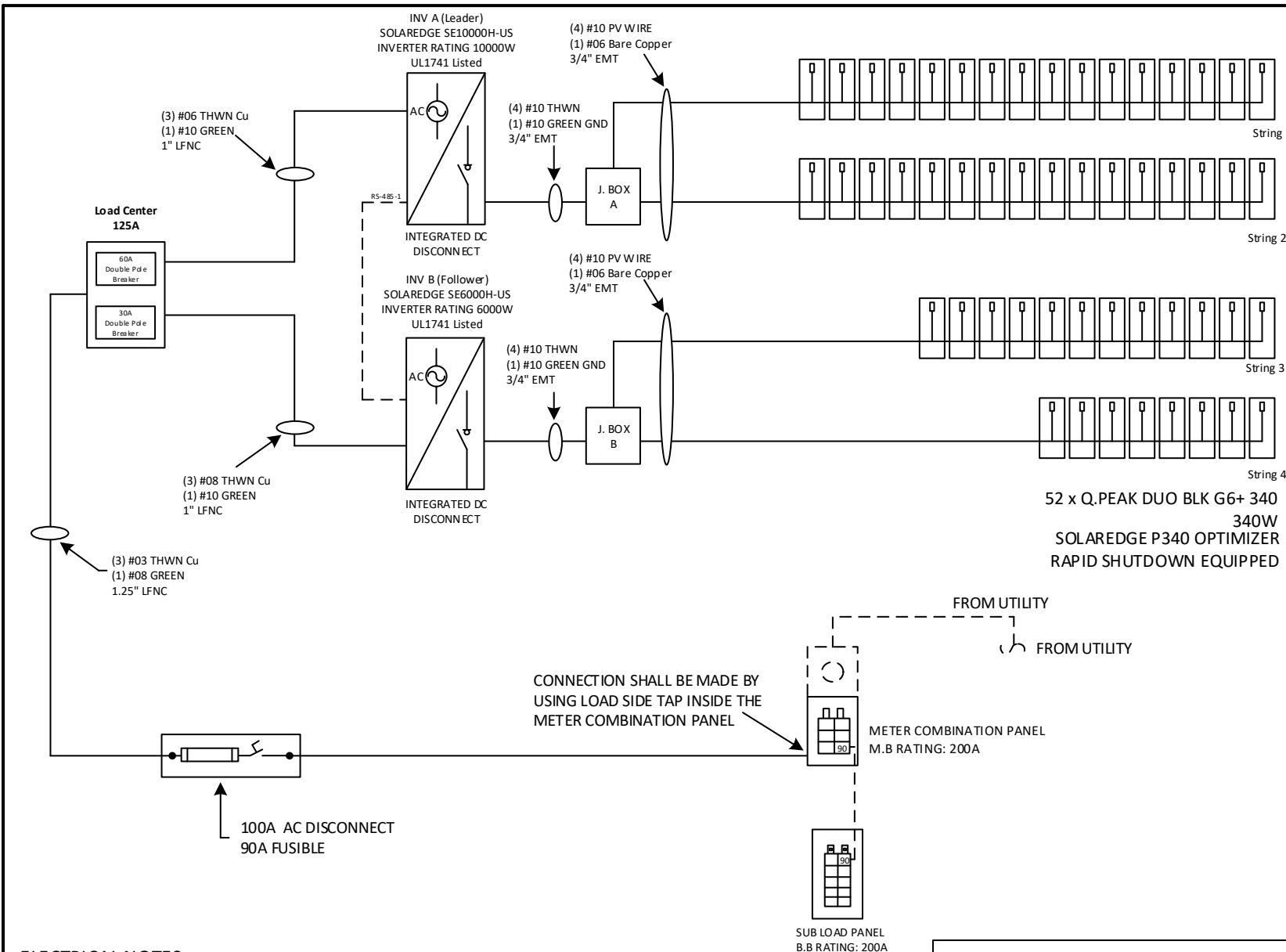

### ELECTRICAL NOTES

- System Size: 17,680 W DC
- (52) Q.PEAK DUO BLK G6+ 340
- (52) SOLAREdge P340 OPTIMIZERS
- (01) SOLAREdge SE10000H-US Inverter
- (01) SOLAREdge SE6000H-US Inverter
- SE10000H-US Output: 42A max @ 240 VAC
- SE6000H-US Output: 25A max @ 240 VAC
- Combined AC output max: 16.0 kVA

STRING 1 & 2:  
16 x 340W = 5,440W ea  
I<sub>mpp</sub> = 13.6 Adc  
I<sub>max</sub> = 23.4 Adc  
V<sub>mpp</sub> = 400 Vdc  
V<sub>oc</sub> = 16 Vdc

STRING 3:  
12 x 340W = 4,080W ea  
I<sub>mpp</sub> = 10.73 Adc  
I<sub>max</sub> = 23.4 Adc  
V<sub>mpp</sub> = 380 Vdc  
V<sub>oc</sub> = 12 Vdc

STRING 4:  
08 x 340W = 2,720W ea  
I<sub>mpp</sub> = 7.15 Adc  
I<sub>max</sub> = 23.4 Adc  
V<sub>mpp</sub> = 380 Vdc  
V<sub>oc</sub> = 08 Vdc

- Grounding will be done via IronRidge grounding mid-clamps and WEEB bonding jumpers to ensure the rail and panels are continuously grounded.
- Rapid Shutdown is included in the inverter, refer to inverter & optimizer attached datasheets.
- The load center / disconnect will be visible, lockable accessible to utility linesmen and will be properly labelled as per NEC requirements. It will be located on the exterior wall of the building, next to the utility meter.

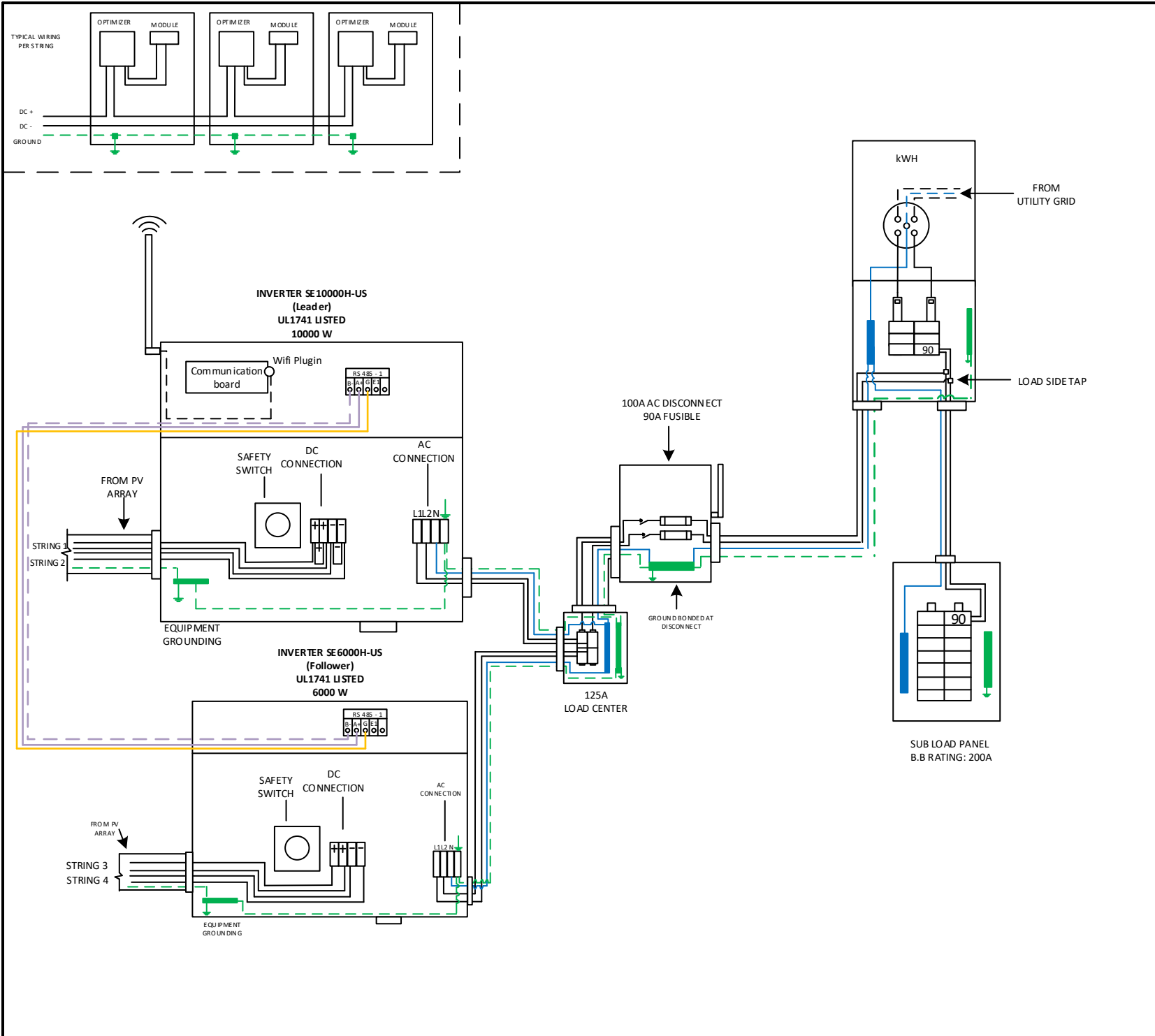

**Jamie Urtz**  
128 Canterbury Rd.,  
Sanford NC 27332



1	05/06/2021	A

JOB NUMBER: 21-85-JU00  
DATE ISSUED: 05/06/2021  
PROJECT STATUS: PERMITTING

**SHEET  
DETAILED ELECTRICAL WIRING  
SCHEMATIC**

Jamie Urtz  
128 Canterbury Rd.,  
Sanford NC 27332



1	05/06/2021	A

JOB NUMBER 21-85-JU00  
DATE ISSUED 05/06/2021  
PROJECT STATUS PERMITTING

SHEET  
**PV LABELS**

JU  
2185JU00-5

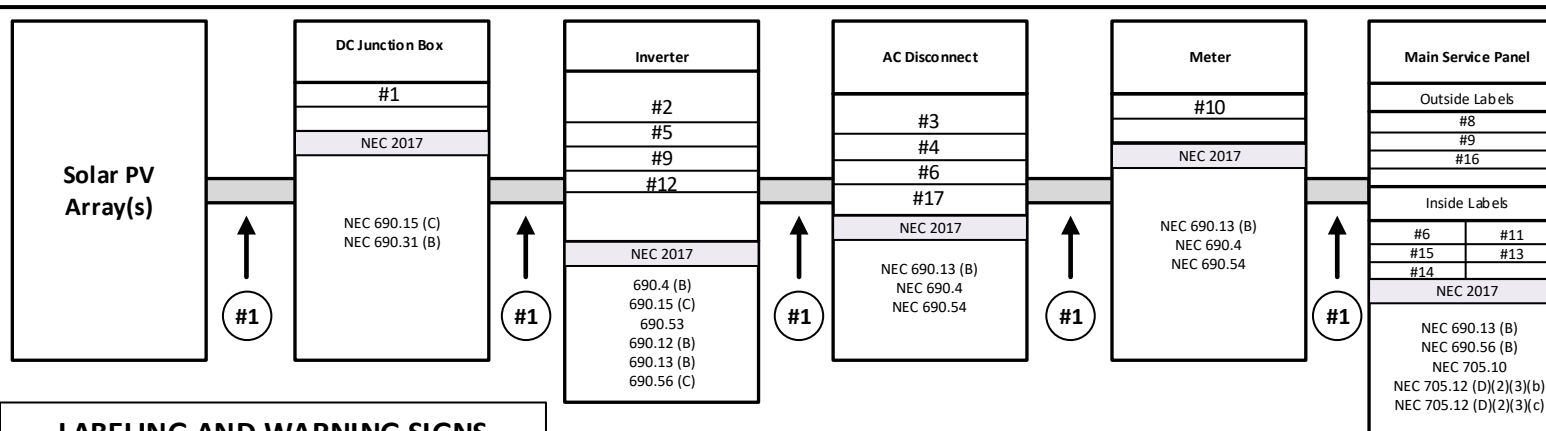

## LABELING AND WARNING SIGNS

### A. PURPOSE

PROVIDE EMERGENCY RESPONDERS WITH APPROPRIATE WARNING AND GUIDANCE WITH RESPECT TO ISOLATING THE SOLAR ELECTRIC SYSTEM. THIS CAN FACILITATE IDENTIFYING ENERGIZED ELECTRICAL LINES THAT CONNECT THE SOLAR PANELS TO THE INVERTER, AS SHOULD NOT BE CUT WHEN VENTING FOR SMOKE REMOVAL.

### B. MAIN SERVICE DISCONNECT:

1. RESIDENTIAL BUILDINGS- THE MARKING MAY BE PLACED WITHIN THE MAIN SERVICE DISCONNECT. THE MARKING SHALL BE PLACED ON THE OUTSIDE COVER IF THE MAIN SERVICE DISCONNECT IS OPERABLE WITH THE SERVICE PANEL CLOSED.

2. COMMERCIAL BUILDINGS- THE MARKINGS SHALL BE PLACED ADJACENT TO THE MAIN SERVICE DISCONNECT CLEARLY VISIBLE FROM THE LOCATION WHERE THE LEVER IS OPERATED

### 3. MARKINGS, VERBIAGE, FORMAT AND TYPE OF MATERIAL

- a. VERBIAGE: CAUTION; SOLAR ELECTRIC SYSTEM CONNECTED  
b. FORMAT:

- (1) WHITE LETTERING ON A RED BACKGROUND  
(2) MINIMUM 3/8 INCH LETTER HEIGHT  
(3) ALL LETTERS SHALL BE CAPITALIZED  
(4) ARIAL OR SIMILAR FONT, NON-BOLD

### c. MATERIAL:

- (1) REFLECTIVE, WEATHER RESISTANT MATERIAL SUITABLE FOR THE ENVIRONMENT (USE UL-969) AS STANDARD FOR WEATHER RATING); DURABLE ADHESIVE MATERIALS MEET THIS REQUIREMENT.

### C. MARKING REQUIREMENTS ON DC CONDUIT, RACEWAYS, ENCLOSURES, CABLE ASSEMBLIES, DC COMBINERS AND JUNCTION BOXES;

#### 1. MARKING: PLACEMENT, VERBIAGE, FORMAT AND TYPE OF MATERIAL.

- a. PLACEMENT: MARKINGS SHALL BE PLACED EVERY 10 (TEN) FEET ON ALL INTERIOR AND EXTERIOR DC CONDUITS, RACEWAYS, ENCLOSURES AND CABLE ASSEMBLIES, AT TURNS ABOVE AND/OR BELOW PENETRATIONS, ALL DC COMBINERS AND JUNCTION BOXES.  
b. VERBIAGE: CAUTION SOLAR CIRCUIT  
c. THE FORMAT AND TYPE OF MATERIAL SHALL ADHERE TO SECTION B-3.B & C ABOVE

### D. INVERTERS ARE NOT REQUIRED TO HAVE CAUTION MARKINGS

#1 **WARNING: PHOTOVOLTAIC POWER SOURCE**

#2 **PHOTOVOLTAIC DC DISCONNECT**

#3 **PHOTOVOLTAIC AC DISCONNECT**

#4 **RAPID SHUTDOWN SWITCH FOR SOLAR PV SYSTEM**

#5 **MAXIMUM VOLTAGE MAXIMUM CIRCUIT CURRENT MAX. RATED OUTPUT CURRENT OF THE CHARGE CONTROLLER OR DC-TO-DC CONVERTER (IF INSTALLED)**

#6 **PHOTOVOLTAIC POWER SOURCE OPERATING AC VOLTAGE MAXIMUM OPERATING AC OUTPUT CURRENT**

#7 **AC DISCONNECT PHOTOVOLTAIC SYSTEM POWER SOURCE RATED AC OUTPUT CURRENT NOMINAL OPERATING AC VOLTAGE**

#8 **WARNING ELECTRIC SHOCK HAZARD TERMINALS ON THE LINE AND LOAD SIDES MAY BE ENERGIZED IN THE OPEN POSITION**

#9 **WARNING DUAL POWER SUPPLY SOURCES: UTILITY GRID AND PV SOLAR ELECTRIC SYSTEM**

#10 **WARNING THIS SERVICE METER IS ALSO SERVED BY A PHOTOVOLTAIC SYSTEM**

#11 **WARNING TURN OFF PHOTOVOLTAIC AC DISCONNECT PRIOR TO WORKING INSIDE PANEL**

#12 **WARNING BIPOLAR PHOTOVOLTAIC ARRAY DISCONNECTION OF NEUTRAL GROUNDED CONDUCTORS MAY RESULT IN OVERVOLTAGE ON ARRAY OR INVERTER**

#13 **WARNING SOLAR ELECTRIC CIRCUIT BREAKER IS BACKFED**

#14 **WARNING THIS EQUIPMENT FED BY MULTIPLE SOURCES. TOTAL RATING OF ALL OVERCURRENT DEVICES, EXCLUDING MAIN SUPPLY OVERCURRENT DEVICE, SHALL NOT EXCEED AMPACITY OF BUSBAR**

#15 **SOLAR PV SYSTEM EQUIPPED WITH RAPID SHUTDOWN**  
TURN RAPID SHUTDOWN SWITCH TO THE "OFF" POSITION TO SHUT DOWN PV SYSTEM AND REDUCE SHOCK HAZARD IN THE ARRAY

#16 **SOLAR AC DISCONNECT LOCATED AT NORTH-EAST SIDE WALL OF THE HOUSE BESIDE THE UTILITY METER**

#17 **SERVICE DISCONNECT LOCATED IN METER COMBINATION PANEL**

Rails and Splices : XR10	Roof Attachment : Flashfoot2
Rafter Spacing : 16 in	There is one layer of shingles Roofing material is asphalt shingles
Attachment Span: 4ft	The roof is located in 116mph wind zone

Utility Meter



Module Dimension		
Roofs	Pitch	Azimuth
A	35°	122°
B	35°	122°
C	35°	305°

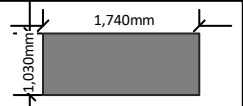

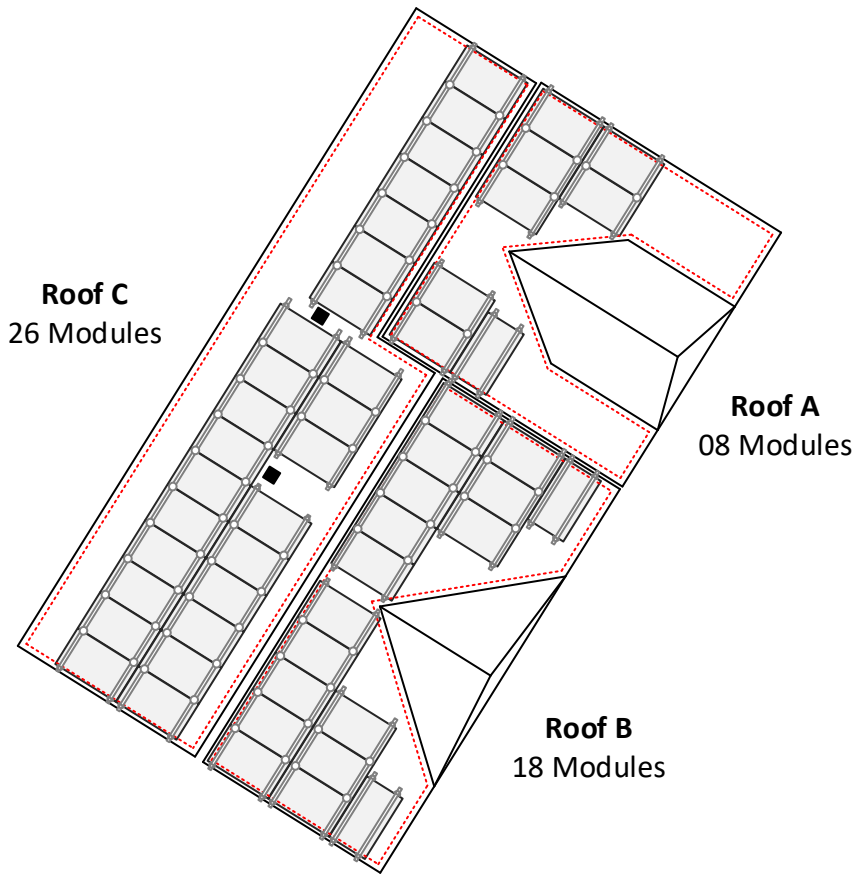

1600 Heritage Commerce Ct Ste 104,  
Wake Forest NC 27587  
O: 919.948.6474  
E: info@8msolar.com

**Jamie Urtz**  
128 Canterbury Rd.,  
Sanford NC 27332

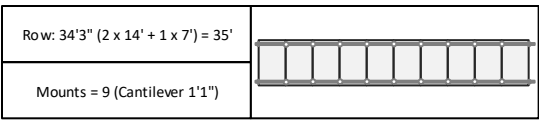

- RAILS AND SPLICES**
- 05 x XR-10-204B: XR10, Rail 204" (17 Feet) Black
  - 25 x XR-10-168B: XR10, Rail 168" (14 Feet) Black
  - 12 x XR-10-BOSS-01-M1: XR10 Bonded Splice (Incl. Self-tapping Screws)
- CLAMPS & GROUNDING**
- 76 x UFO-CL-01-B1: Universal Module Clamp, Black
  - 56 x CAMO-01-M1: Hidden End Cam (universal clamp)
  - 16 x XR-LUG-03-A1: Grounding Lug, Low Profile
- ATTACHMENTS**
- 108 x FF2-01-M2: FlashFoot2, Mill
  - 108 x BHW-SQ-02-A1: Square-Bolt Bonding Hardware
- ACCESSORIES**
- 03 x XR-10-CAP: Kit, End Cap XR10 (10 sets per bag)
  - 52 x BHW-MI-01-A1: Microinverter Bonding Hardware, T-Bolt

- SOLAR MODULES**
- 52 x Q. Peel Duo Blk G6+ 340
- INVERTER & SUPPORTING ITEMS**
- 01 x SolarEdge SE10000H-US
  - 01 x SolarEdge SE6000H-US
  - 52 x SolarEdge Power Optimizer P340
  - 01 x SE-WFGW-B-S1-NA with Antenna kit
  - 02 x PV Labels kit
- WIRE & DISCONNECTS**
- 500 ft x PV WIRE BLK (Cu)



6" clearance  
from each side  
of the roof

Row: 17'2" (1 x 14' + 1 x 7') = 21'		Row: 5' 11" (1 x 7') = 7'	
Mounts = 5 (Cantilever 7")		Mounts = 02 (Cantilever 11")	
Row: 20'7" (1 x 14' + 1 x 7') = 21'		Row: 6' 11" (1 x 8') = 8'	
Mounts = 6 (Cantilever 4")		Mounts = 02 (Cantilever 1'6")	
Row: 24' (1 x 17' + 1 x 8') = 25'		Cut one 17' rail into half and use	
Mounts = 6 (Cantilever 0")		Row: 10'4" (1 x 14') = 14'	
		Mounts = 03 (Cantilever 1'2")	

**BILL OF MATERIAL**  
SCALE: 13/200" - 1' 0"

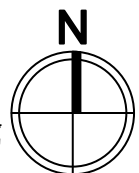

1	05/06/2021	A
—	—	—
—	—	—
—	—	—
—	—	—
—	—	—

JOB NUMBER  
21-85-JU00

DATE ISSUED  
05/06/2020

PROJECT STATUS  
PERMITTING

SHEET  
**BILL OF MATERIAL**

JU  
2185JU00-6

# Q.PEAK DUO BLK-G6+ 330-345

ENDURING HIGH  
PERFORMANCE



### Q.ANTUM TECHNOLOGY: LOW LEVELIZED COST OF ELECTRICITY

Higher yield per surface area, lower BOS costs, higher power classes, and an efficiency rate of up to 19.5%.



### INNOVATIVE ALL-WEATHER TECHNOLOGY

Optimal yields, whatever the weather with excellent low-light and temperature behavior.



### ENDURING HIGH PERFORMANCE

Long-term yield security with Anti LID and Anti PID Technology<sup>1</sup>, Hot-Spot Protect and Traceable Quality Tra.Q™.



### EXTREME WEATHER RATING

High-tech aluminum alloy frame, certified for high snow (5400 Pa) and wind loads (4000 Pa).



### A RELIABLE INVESTMENT

Inclusive 25-year product warranty and 25-year linear performance warranty<sup>2</sup>.



### STATE OF THE ART MODULE TECHNOLOGY

Q.ANTUM DUO combines cutting edge cell separation and innovative wiring with Q.ANTUM Technology.

<sup>1</sup> APT test conditions according to IEC/TS 62804-1:2015, method B (-1500 V, 168h)

<sup>2</sup> See data sheet on rear for further information

### THE IDEAL SOLUTION FOR:



Rooftop arrays on residential buildings



## MECHANICAL SPECIFICATION

Format	68.5 × 40.6 × 1.26 in (including frame) (1740 × 1030 × 32 mm)
Weight	43.9 lbs (19.9 kg)
Front Cover	0.13 in (3.2 mm) thermally pre-stressed glass with anti-reflection technology
Back Cover	Composite film
Frame	Black anodized aluminum
Cell	6 × 20 monocrystalline Q.ANTUM solar half cells
Junction Box	2.09-3.98 × 1.26-2.36 × 0.59-0.71 in (53-101 × 32-60 × 15-18 mm), Protection class IP67, with bypass diodes
Cable	4 mm <sup>2</sup> Solar cable; (+) ≥ 45.3 in (1150 mm), (-) ≥ 45.3 in (1150 mm)
Connector	Stäubli MC4, Hanwha Q CELLS HQC4, Amphenol UTX, Renhe 05-6, Tongling TL-Cable01S, JMTHY JM601; IP68 or Friends PV2e; IP67

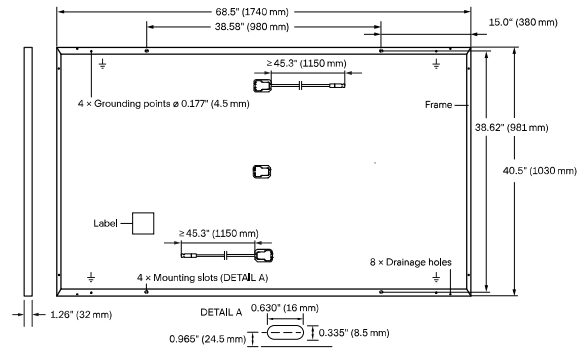

## ELECTRICAL CHARACTERISTICS

POWER CLASS			330	335	340	345
MINIMUM PERFORMANCE AT STANDARD TEST CONDITIONS, STC <sup>1</sup> (POWER TOLERANCE +5 W / -0 W)						
Minimum	Power at MPP <sup>1</sup>	P <sub>MPP</sub> [W]	330	335	340	345
	Short Circuit Current <sup>1</sup>	I <sub>SC</sub> [A]	10.41	10.47	10.52	10.58
	Open Circuit Voltage <sup>1</sup>	V <sub>OC</sub> [V]	40.15	40.41	40.66	40.92
	Current at MPP	I <sub>MPP</sub> [A]	9.91	9.97	10.02	10.07
	Voltage at MPP	V <sub>MPP</sub> [V]	33.29	33.62	33.94	34.25
	Efficiency <sup>1</sup>	η [%]	≥ 18.4	≥ 18.7	≥ 19.0	≥ 19.3
MINIMUM PERFORMANCE AT NORMAL OPERATING CONDITIONS, NMOT <sup>2</sup>						
Minimum	Power at MPP	P <sub>MPP</sub> [W]	247.0	250.7	254.5	258.2
	Short Circuit Current	I <sub>SC</sub> [A]	8.39	8.43	8.48	8.52
	Open Circuit Voltage	V <sub>OC</sub> [V]	37.86	38.10	38.34	38.59
	Current at MPP	I <sub>MPP</sub> [A]	7.80	7.84	7.89	7.93
	Voltage at MPP	V <sub>MPP</sub> [V]	31.66	31.97	32.27	32.57

<sup>1</sup>Measurement tolerances P<sub>MPP</sub> ± 3%; I<sub>SC</sub>; V<sub>OC</sub> ± 5% at STC: 1000 W/m<sup>2</sup>, 25 ± 2°C, AM 1.5 according to IEC 60904-3 • 800 W/m<sup>2</sup>, NMOT, spectrum AM 1.5

### Q CELLS PERFORMANCE WARRANTY

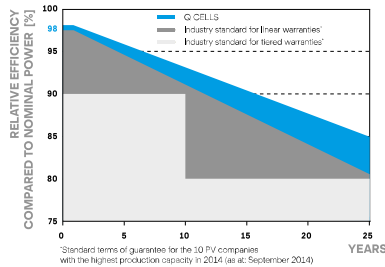

At least 98% of nominal power during first year. Thereafter max. 0.54% degradation per year. At least 93.1% of nominal power up to 10 years. At least 85% of nominal power up to 25 years.

All data within measurement tolerances. Full warranties in accordance with the warranty terms of the Q CELLS sales organization of your respective country.

### PERFORMANCE AT LOW IRRADIANCE

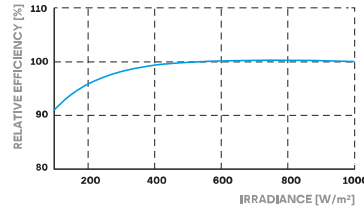

Typical module performance under low irradiance conditions in comparison to STC conditions (25°C, 1000 W/m<sup>2</sup>)

### TEMPERATURE COEFFICIENTS

Temperature Coefficient of I <sub>SC</sub>	α [%/K]	+0.04	Temperature Coefficient of V <sub>OC</sub>	β [%/K]	-0.27
Temperature Coefficient of P <sub>MPP</sub>	γ [%/K]	-0.36	Normal Module Operating Temperature	NMOT [°F]	109 ± 5.4 (43 ± 3°C)

## PROPERTIES FOR SYSTEM DESIGN

Maximum System Voltage V <sub>sys</sub>	[V]	1000 (IEC)/1000 (UL)	Safety Class	II
Maximum Series Fuse Rating	[A DC]	20	Fire Rating based on ANSI / UL 1703	C (IEC)/TYPE 2 (UL)
Max. Design Load, Push / Pull <sup>3</sup>	[lbs / ft <sup>2</sup> ]	75 (3600 Pa) / 55 (2667 Pa)	Permitted Module Temperature on Continuous Duty	-40°F up to +185°F (-40°C up to +85°C)
Max. Test Load, Push / Pull <sup>3</sup>	[lbs / ft <sup>2</sup> ]	113 (5400 Pa) / 84 (4000 Pa)		

<sup>3</sup>See Installation Manual

## QUALIFICATIONS AND CERTIFICATES

UL 1703, VDE Quality Tested, CE-compliant, IEC 61215:2016, IEC 61730:2016, Application Class II, U.S. Patent No. 9,893,215 (solar cells)



## PACKAGING INFORMATION

Number of Modules per Pallet	32
Number of Pallets per 53' Trailer	28
Number of Pallets per 40' HC-Container	24
Pallet Dimensions (L × W × H)	71.5 × 45.3 × 48.0 in (1815 × 1150 × 1220 mm)
Pallet Weight	1505 lbs (683 kg)

**Note:** Installation instructions must be followed. See the installation and operating manual or contact our technical service department for further information on approved installation and use of this product.

Hanwha Q CELLS America Inc.

400 Spectrum Center Drive, Suite 1400, Irvine, CA 92618, USA | TEL +1 949 748 59 96 | EMAIL inquiry@us.q-cells.com | WEB www.q-cells.us

# Single Phase Inverter with HD-Wave Technology

for North America

SE3000H-US / SE3800H-US / SE5000H-US / SE6000H-US /  
SE7600H-US / SE10000H-US / SE11400H-US



## Optimized installation with HD-Wave technology

- / Specifically designed to work with power optimizers
- / Record-breaking 99% weighted efficiency
- / Quick and easy inverter commissioning directly from a smartphone using the SolarEdge SetApp
- / Fixed voltage inverter for longer strings
- / Integrated arc fault protection and rapid shutdown for NEC 2014 and 2017, per article 690.11 and 690.12
- / UL1741 SA certified, for CPUC Rule 21 grid compliance
- / Small, lightweight, and easy to install both outdoors or indoors
- / Built-in module-level monitoring
- / Optional: Faster installations with built-in consumption metering (1% accuracy) and production revenue grade metering (0.5% accuracy, ANSI C12.20)

# / Single Phase Inverter with HD-Wave Technology for North America

SE3000H-US / SE3800H-US / SE5000H-US / SE6000H-US/  
SE7600H-US / SE10000H-US / SE11400H-US

MODEL NUMBER	SE3000H-US	SE3800H-US	SE5000H-US	SE6000H-US	SE7600H-US	SE10000H-US	SE11400H-US	
APPLICABLE TO INVERTERS WITH PART NUMBER	SEXXXXH-XXXXXBXX4							
<b>OUTPUT</b>								
Rated AC Power Output	3000	3800 @ 240V 3300 @ 208V	5000	6000 @ 240V 5000 @ 208V	7600	10000	11400 @ 240V 10000 @ 208V	VA
Maximum AC Power Output	3000	3800 @ 240V 3300 @ 208V	5000	6000 @ 240V 5000 @ 208V	7600	10000	11400 @ 240V 10000 @ 208V	VA
AC Output Voltage Min.-Nom.-Max. (211 - 240 - 264)	✓	✓	✓	✓	✓	✓	✓	Vac
AC Output Voltage Min.-Nom.-Max. (183 - 208 - 229)	-	✓	-	✓	-	-	✓	Vac
AC Frequency (Nominal)	59.3 - 60 - 60.5 <sup>(1)</sup>							Hz
Maximum Continuous Output Current @240V	12.5	16	21	25	32	42	47.5	A
Maximum Continuous Output Current @208V	-	16	-	24	-	-	48.5	A
Power Factor	1, Adjustable - 0.85 to 0.85							
GFDI Threshold	1							A
Utility Monitoring, Islanding Protection, Country Configurable Thresholds	Yes							
<b>INPUT</b>								
Maximum DC Power @240V	4650	5900	7750	9300	11800	15500	17650	W
Maximum DC Power @208V	-	5100	-	7750	-	-	15500	W
Transformer-less, Ungrounded	Yes							
Maximum Input Voltage	480							Vdc
Nominal DC Input Voltage	380				400			Vdc
Maximum Input Current @240V <sup>(2)</sup>	8.5	10.5	13.5	16.5	20	27	30.5	Adc
Maximum Input Current @208V <sup>(2)</sup>	-	9	-	13.5	-	-	27	Adc
Max. Input Short Circuit Current	45							Adc
Reverse-Polarity Protection	Yes							
Ground-Fault Isolation Detection	600k $\Omega$ Sensitivity							
Maximum Inverter Efficiency	99	99.2						%
CEC Weighted Efficiency	99						99 @ 240V 98.5 @ 208V	%
Nighttime Power Consumption	< 2.5							W

<sup>(1)</sup> For other regional settings please contact SolarEdge support

<sup>(2)</sup> A higher current source may be used; the inverter will limit its input current to the values stated

# / Single Phase Inverter with HD-Wave Technology for North America

SE3000H-US / SE3800H-US / SE5000H-US / SE6000H-US/  
SE7600H-US / SE10000H-US / SE11400H-US

MODEL NUMBER	SE3000H-US	SE3800H-US	SE5000H-US	SE6000H-US	SE7600H-US	SE10000H-US	SE11400H-US		
<b>ADDITIONAL FEATURES</b>									
Supported Communication Interfaces	RS485, Ethernet, ZigBee (optional), Cellular (optional)								
Revenue Grade Metering, ANSI C12.20	Optional <sup>(3)</sup>								
Consumption metering									
Inverter Commissioning	With the SetApp mobile application using Built-in Wi-Fi Access Point for Local Connection								
Rapid Shutdown - NEC 2014 and 2017 690.12	Automatic Rapid Shutdown upon AC Grid Disconnect								
<b>STANDARD COMPLIANCE</b>									
Safety	UL1741, UL1741 SA, UL1699B, CSA C22.2, Canadian AFCl according to T.I.L. M-07								
Grid Connection Standards	IEEE1547, Rule 21, Rule 14 (HI)								
Emissions	FCC Part 15 Class B								
<b>INSTALLATION SPECIFICATIONS</b>									
AC Output Conduit Size / AWG Range	1" Maximum / 14-6 AWG				1" Maximum /14-4 AWG				
DC Input Conduit Size / # of Strings / AWG Range	1" Maximum / 1-2 strings / 14-6 AWG				1" Maximum / 1-3 strings / 14-6 AWG				
Dimensions with Safety Switch (HxWxD)	17.7 x 14.6 x 6.8 / 450 x 370 x 174				21.3 x 14.6 x 7.3 / 540 x 370 x 185				in / mm
Weight with Safety Switch	22 / 10	25.1 / 11.4	26.2 / 11.9	38.8 / 17.6					lb / kg
Noise	< 25				<50				dBA
Cooling	Natural Convection								
Operating Temperature Range	-40 to +140 / -40 to +60 <sup>(4)</sup>								°F / °C
Protection Rating	NEMA 4X (Inverter with Safety Switch)								

<sup>(3)</sup> Inverter with Revenue Grade Meter P/N: SExxxxH-US000BNC4; Inverter with Revenue Grade Production and Consumption Meter P/N: SExxxxH-US000BN14 . For consumption metering, current transformers should be ordered separately: SEACT0750-200NA-20 or SEACT0750-400NA-20. 20 units per box

<sup>(4)</sup> Full power up to at least 50°C / 122°F; for power de-rating information refer to: <https://www.solaredge.com/sites/default/files/se-temperature-derating-note-na.pdf>

## How to Enable Consumption Monitoring

By simply wiring current transformers through the inverter's existing AC conduits and connecting them to the service panel, homeowners will gain full insight into their household energy usage helping them to avoid high electricity bills

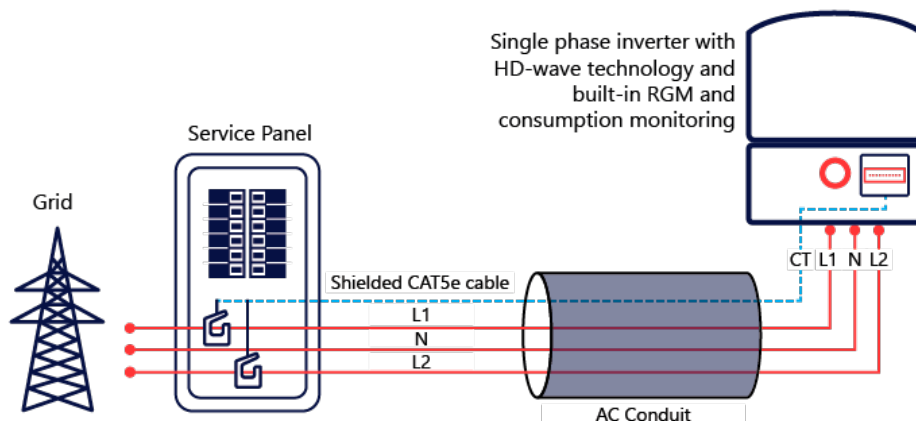

---

# Power Optimizer

For North America

P320 / P340 / P370 / P400 / P401 / P405 / P485 / P505

POWER OPTIMIZER



## PV power optimization at the module-level

- Specifically designed to work with SolarEdge inverters
- Up to 25% more energy
- Superior efficiency (99.5%)
- Mitigates all types of module mismatch losses, from manufacturing tolerance to partial shading
- Flexible system design for maximum space utilization
- Fast installation with a single bolt
- Next generation maintenance with module-level monitoring
- Meets NEC requirements for arc fault protection (AFCI) and Photovoltaic Rapid Shutdown System (PVRSS)
- Module-level voltage shutdown for installer and firefighter safety

# Power Optimizer

## For North America

P320 / P340 / P370 / P400 / P401 / P405 / P485 / P505

Optimizer model (typical module compatibility)	P320 (for 60-cell modules)	P340 (for high-power 60-cell modules)	P370 (for higher-power 60 and 72-cell modules)	P400 (for 72 & 96-cell modules)	P401 (for high power 60 and 72 cell modules)	P405 (for high-voltage modules)	P485 (for high-voltage modules)	P505 (for higher current modules)		
<b>INPUT</b>										
Rated Input DC Power <sup>(1)</sup>	320	340	370	400		405	485	505	W	
Absolute Maximum Input Voltage (Voc at lowest temperature)	48		60	80	60	125 <sup>(2)</sup>		83 <sup>(2)</sup>	Vdc	
MPPT Operating Range	8 - 48		8 - 60	8 - 80	8-60	12.5 - 105		12.5 - 83	Vdc	
Maximum Short Circuit Current (Isc)	11			10.1	11.75	11		14	Adc	
Maximum DC Input Current	13.75			12.5	14.65	12.5		17.5	Adc	
Maximum Efficiency	99.5								%	
Weighted Efficiency	98.8							98.6	%	
Overvoltage Category	II									
<b>OUTPUT DURING OPERATION (POWER OPTIMIZER CONNECTED TO OPERATING SOLAREEDGE INVERTER)</b>										
Maximum Output Current	15								Adc	
Maximum Output Voltage	60					85			Vdc	
<b>OUTPUT DURING STANDBY (POWER OPTIMIZER DISCONNECTED FROM SOLAREEDGE INVERTER OR SOLAREEDGE INVERTER OFF)</b>										
Safety Output Voltage per Power Optimizer	1 ± 0.1								Vdc	
<b>STANDARD COMPLIANCE</b>										
EMC	FCC Part15 Class B, IEC61000-6-2, IEC61000-6-3									
Safety	IEC62109-1 (class II safety), UL1741									
Material	UL94 V-0, UV Resistant									
RoHS	Yes									
<b>INSTALLATION SPECIFICATIONS</b>										
Maximum Allowed System Voltage	1000								Vdc	
Compatible inverters	All SolarEdge Single Phase and Three Phase inverters									
Dimensions (W x L x H)	129 x 153 x 27.5 / 5.1 x 6 x 1.1			129 x 153 x 33.5 / 5.1 x 6 x 1.3	129 x 153 x 29.5 / 5.1 x 6 x 1.16	129 x 159 x 49.5 / 5.1 x 6.3 x 1.9		129 x 162 x 59 / 5.1 x 6.4 x 2.3	mm / in	
Weight (including cables)	630 / 1.4			750 / 1.7	655 / 1.5	845 / 1.9		1064 / 2.3	gr / lb	
Input Connector	MC4 <sup>(3)</sup>						Single or dual MC4 <sup>(3)(4)</sup>	MC4 <sup>(3)</sup>		
Input Wire Length	0.16 / 0.52								m / ft	
Output Wire Type / Connector	Double Insulated / MC4									
Output Wire Length	0.9 / 2.95			1.2 / 3.9						m / ft
Operating Temperature Range <sup>(5)</sup>	-40 - +85 / -40 - +185								°C / °F	
Protection Rating	IP68 / NEMA6P									
Relative Humidity	0 - 100								%	

(1) Rated power of the module at STC will not exceed the optimizer "Rated Input DC Power". Modules with up to +5% power tolerance are allowed

(2) NEC 2017 requires max input voltage be not more than 80V

(3) For other connector types please contact SolarEdge

(4) For dual version for parallel connection of two modules use P485-4NMDMRM. In the case of an odd number of PV modules in one string, installing one P485 dual version power optimizer connected to one PV module. When connecting a single module seal the unused input connectors with the supplied pair of seals.

(5) For ambient temperature above +85°C / +185°F power de-rating is applied. Refer to Power Optimizers Temperature De-Rating Technical Note for more details.

PV System Design Using a SolarEdge Inverter <sup>(6)(7)</sup>	Single Phase HD-Wave	Single phase	Three Phase for 208V grid	Three Phase for 277/480V grid	
Minimum String Length (Power Optimizers)	P320, P340, P370, P400, P401	8	10	18	
	P405, P485, P505	6	8	14	
Maximum String Length (Power Optimizers)		25	25	50 <sup>(8)</sup>	
Maximum Power per String	5700 (6000 with SE7600-US - SE11400-US)	5250	6000 <sup>(9)</sup>	12750 <sup>(10)</sup>	W
Parallel Strings of Different Lengths or Orientations	Yes				

(6) For detailed string sizing information refer to: [http://www.solaredge.com/sites/default/files/string\\_sizing\\_na.pdf](http://www.solaredge.com/sites/default/files/string_sizing_na.pdf)

(7) It is not allowed to mix P405/P485/P505 with P320/P340/P370/P400/P401 in one string

(8) A string with more than 30 optimizers does not meet NEC rapid shutdown requirements; safety voltage will be above the 30V requirement

(9) For 208V grid: it is allowed to install up to 6,500W per string when the maximum power difference between each string is 1,000W

(10) For 277/480V grid: it is allowed to install up to 15,000W per string when the maximum power difference between each string is 2,000W

Subject: ETL Evaluation of SolarEdge Products to NEC 2017 Rapid Shutdown Requirements

To, whom it may concern

This letter represents the testing results of the below listed products to the requirements contained in the following standards:

The evaluation was done on the PV Rapid Shutdown System (PVRSS), and covers installations consisting of optimizers and inverters with part numbers listed below.

The testing done has verified that controlled conductors are limited to:

- Not more than 30 volts and 240 voltamperes within 30 seconds of rapid shutdown initiation outside the array.
- Not more than 80 volts and 240 voltamperes within 30 seconds of rapid shutdown initiation inside the array.

The rapid shutdown initiation is performed by either disconnecting the AC feed to the inverter, or – if the inverter DC Safety switch is readily accessible – by turning off the DC Safety switch.

**Applicable products:**

(1) Power optimizers:

PB followed by 001 to 350; followed by -AOB or -TFI.

OP followed by 001 to 500; followed by -LV, -MV, -IV or -EV.

P followed by 001 to 860.

SP followed by 001 to 350.

When optimizers are connected to 2 or more modules in series, the max input voltage may exceed 80V. Following the implementation of the NEC 2017 rapid shutdown value of 80V max inside of the array at the beginning of 2019, modules exceeding this combined input max voltage will be required to use optimizers with parallel inputs.

(2) 1 -PH Inverters

SE3000A-US / SE3800A-US / SE5000A-US / SE6000A-US / SE7600A-US / SE10000A-US / SE11400A-US / SE3000H-US / SE3800H-US / SE5000H-US / SE6000H-US / SE7600H-US / SE10000H-US / SE11400H-US when the following label is labeled on the side of the inverter:

Inverter part number may be followed by a suffix.

(3) 3 -PH Inverters

SE9KUS / SE10KUS / SE14.4KUS / SE20KUS / SE30KUS / SE33.3KUS / SE43.2KUS / SE66.6KUS / SE100KUS; when the following label is labeled on the side of the inverter:

Please note, this Letter Report does not represent authorization for the use of any Intertek certification marks.

<b>Brand Name(s)</b>	SolarEdge
<b>Relevant Standard(s)</b>	UL 1741, UL 1741 CRD for rapid shutdown  National Electric Code, 2017, Section 690.12 requirement for rapid shutdown
<b>Verification Issuing Office</b>	3933 US Route 11, Cortland, NY 13045

*NRTL Disclaimer, Different for each NRTL – Example: "This Verification is for the exclusive use of NRTL's Client and is provided pursuant to the agreement between NRTL and its Client. NRTL's responsibility and liability are limited to the terms and conditions of the agreement. NRTL assumes no liability to any party, other than to the Client in accordance with the agreement, for any loss, expense or damage occasioned by the use of this Verification. Only the Client is authorized to copy or distribute this Verification. Any use of the NRTL name or one of its marks for the sale or advertisement of the tested material, product or service must first be approved in writing by NRTL. The observations and test results referenced from this Verification are relevant only to the sample tested. This Verification by itself does not imply that the material, product, or service is or has ever been under an NRTL certification program."*

Signature: 

Name: Mukund Rana  
Position: Engineering Team Leader  
Date: 2/11/2020



## Solar Is Not Always Sunny

Over their lifetime, solar panels experience countless extreme weather events. Not just the worst storms in years, but the worst storms in 40 years. High winds capable of ripping panels from a roof, and snowfalls weighing enough to buckle a panel frame.

XR Rails are the structural backbone preventing these results. They resist uplift, protect against buckling and safely and efficiently transfer loads into the building structure. Their superior spanning capability requires fewer roof attachments, reducing the number of roof penetrations and the amount of installation time.

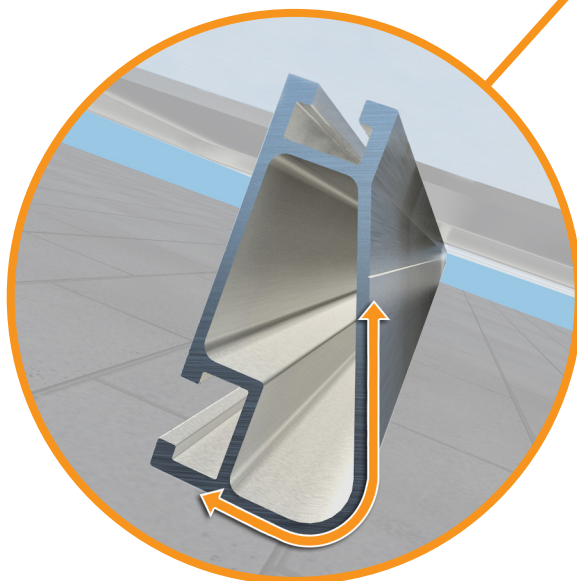
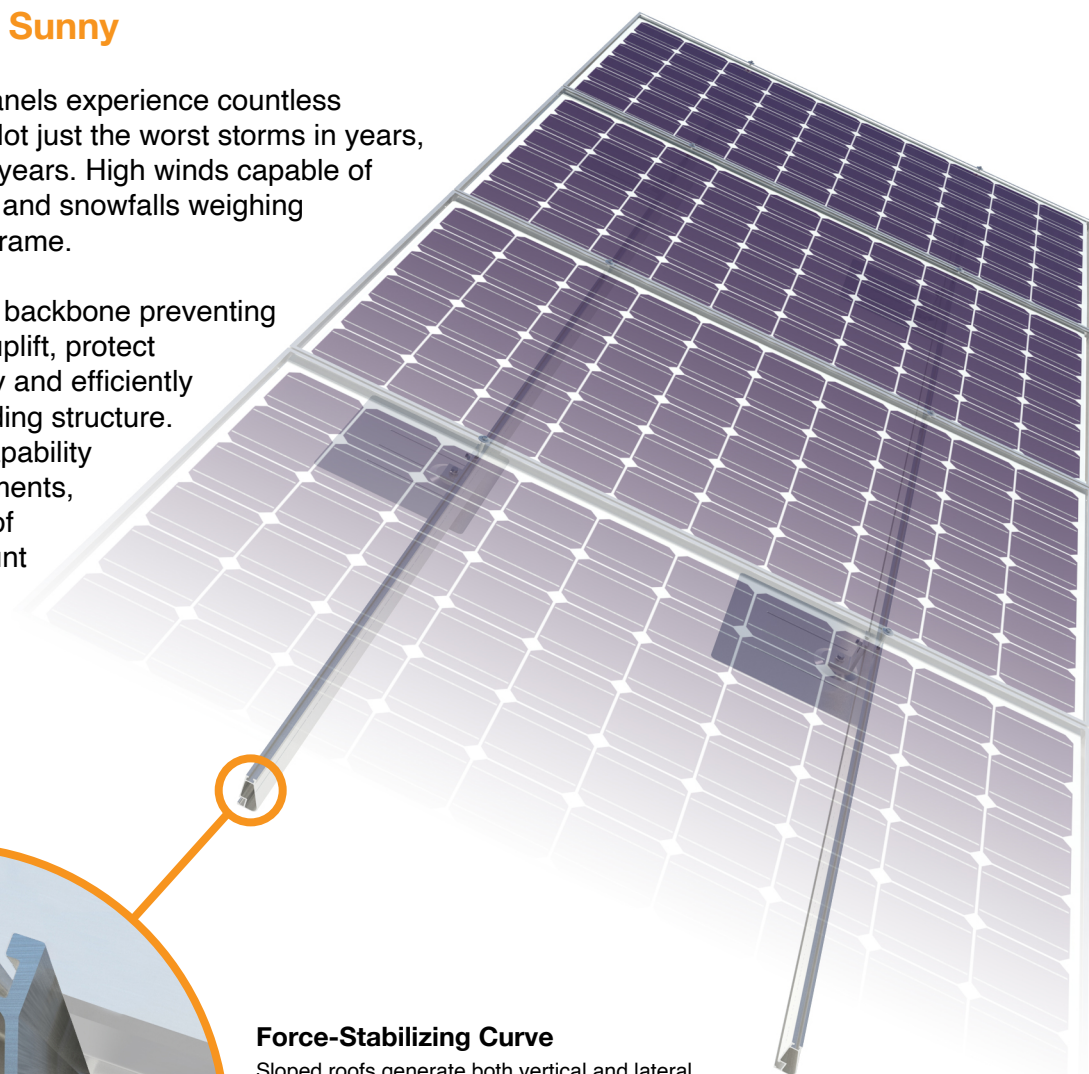

### Force-Stabilizing Curve

Sloped roofs generate both vertical and lateral forces on mounting rails which can cause them to bend and twist. The curved shape of XR Rails is specially designed to increase strength in both directions while resisting the twisting. This unique feature ensures greater security during extreme weather and a longer system lifetime.

### Compatible with Flat & Pitched Roofs



XR Rails are compatible with FlashFoot and other pitched roof attachments.



IronRidge offers a range of tilt leg options for flat roof mounting applications.

### Corrosion-Resistant Materials

All XR Rails are made of 6000-series aluminum alloy, then protected with an anodized finish. Anodizing prevents surface and structural corrosion, while also providing a more attractive appearance.

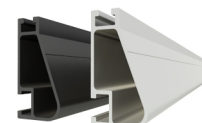

## XR Rail Family

The XR Rail Family offers the strength of a curved rail in three targeted sizes. Each size supports specific design loads, while minimizing material costs. Depending on your location, there is an XR Rail to match.



### XR10

XR10 is a sleek, low-profile mounting rail, designed for regions with light or no snow. It achieves spans up to 6 feet, while remaining light and economical.

- 6' spanning capability
- Moderate load capability
- Clear & black anodized finish
- Internal splices available



### XR100

XR100 is the ultimate residential mounting rail. It supports a range of wind and snow conditions, while also maximizing spans up to 10 feet.

- 10' spanning capability
- Heavy load capability
- Clear & black anodized finish
- Internal splices available

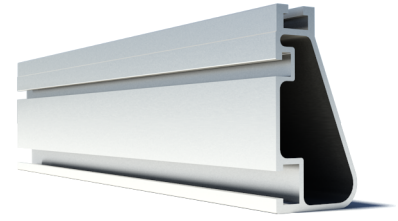

### XR1000

XR1000 is a heavyweight among solar mounting rails. It's built to handle extreme climates and spans up to 12 feet for commercial applications.

- 12' spanning capability
- Extreme load capability
- Clear anodized finish
- Internal splices available

## Rail Selection

The table below was prepared in compliance with applicable engineering codes and standards.\* Values are based on the following criteria: ASCE 7-16, Gable Roof Flush Mount, Roof Zones 1 & 2e, Exposure B, Roof Slope of 8 to 20 degrees and Mean Building Height of 30 ft. Visit [IronRidge.com](http://IronRidge.com) for detailed certification letters.

Load		Rail Span					
Snow (PSF)	Wind (MPH)	4'	5' 4"	6'	8'	10'	12'
None	90						
	120						
	140	XR10		XR100		XR1000	
	160						
20	90						
	120						
	140						
	160						
30	90						
	160						
40	90						
	160						
80	160						
120	160						

\*Table is meant to be a simplified span chart for conveying general rail capabilities. Use approved certification letters for actual design guidance.

## The Strongest Attachment in Solar

IronRidge FlashFoot2 raises the bar in solar roof protection. The unique water seal design is both elevated and encapsulated, delivering redundant layers of protection against water intrusion. In addition, the twist-on Cap perfectly aligns the rail attachment with the lag bolt to maximize mechanical strength.

### Twist-On Cap

FlashFoot2's unique Cap design encapsulates the lag bolt and locks into place with a simple twist. The Cap helps FlashFoot2 deliver superior structural strength, by aligning the rail and lag bolt in a concentric load path.

### Single Socket Size

A custom-design lag bolt allows you to install FlashFoot2 with the same 7/16" socket size used on other Flush Mount System components.

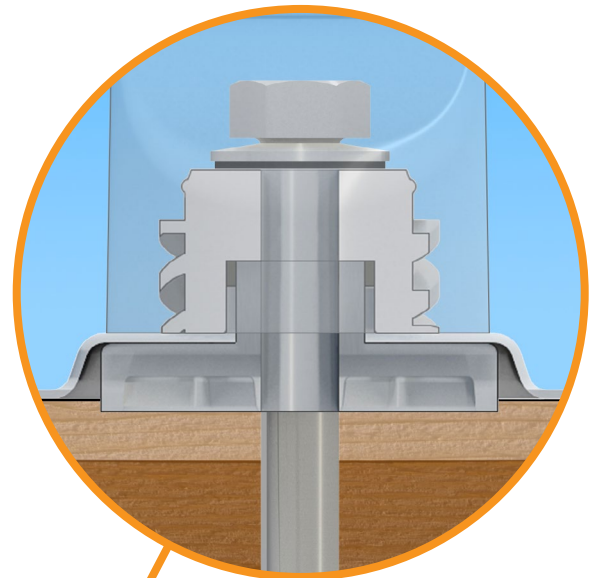

### Three-Tier Water Seal

FlashFoot2's seal architecture utilizes three layers of protection. An elevated platform diverts water away, while a stack of rugged components raises the seal an entire inch. The seal is then fully-encapsulated by the Cap. FlashFoot2 is the first solar attachment to pass the TAS-100 Wind-Driven Rain Test.

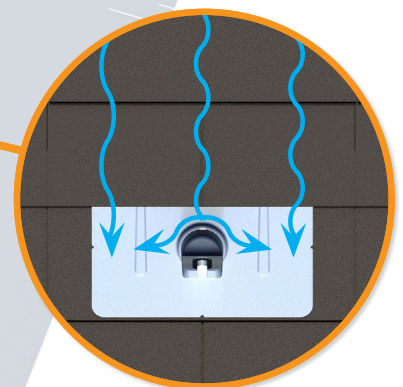
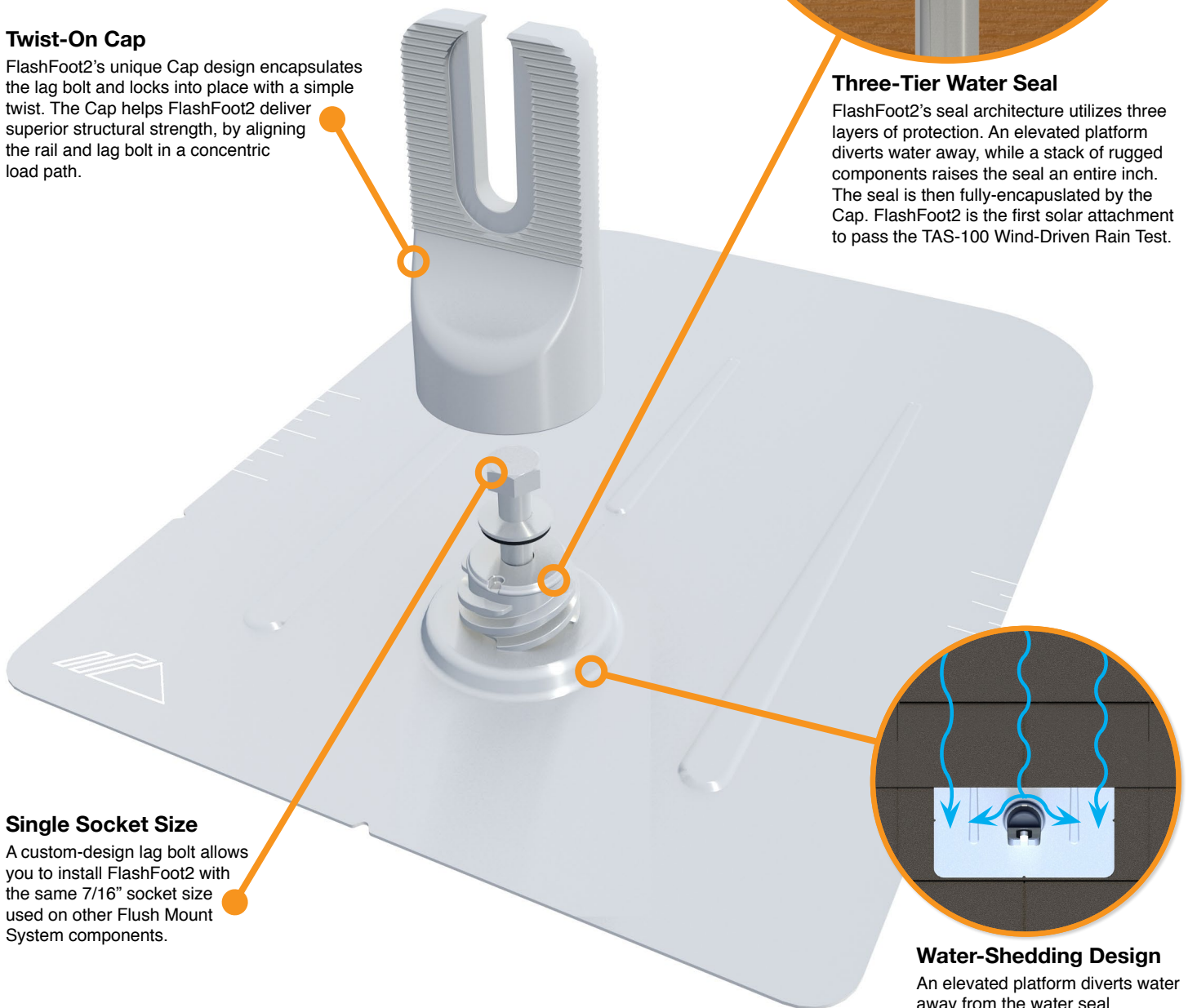

### Water-Shedding Design

An elevated platform diverts water away from the water seal.

## Installation Features

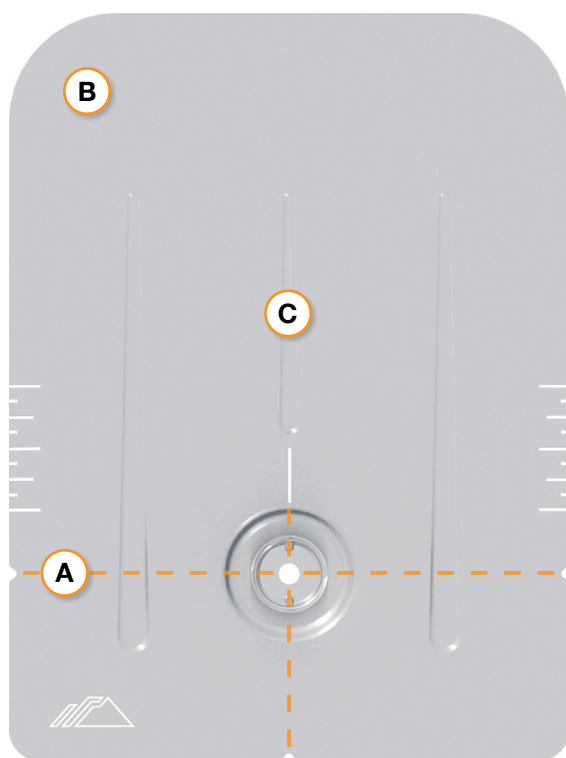

### A Alignment Markers

Quickly align the flashing with chalk lines to find pilot holes.

### B Rounded Corners

Makes it easier to handle and insert under the roof shingles.

### C Reinforcement Ribs

Help to stiffen the flashing and prevent any bending or crinkling during installation.

## Benefits of Concentric Loading

Traditional solar attachments have a horizontal offset between the rail and lag bolt, which introduces leverage on the lag bolt and decreases uplift capacity.

FlashFoot2 is the only product to align the rail and lag bolt. This concentric loading design results in a stronger attachment for the system.

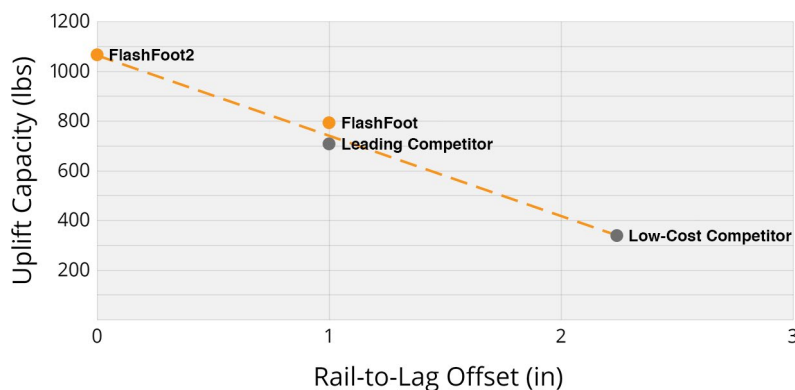

## Testing & Certification

### Structural Certification

Designed and Certified for Compliance with the International Building Code & ASCE/SEI-7.

### Water Seal Ratings

Water Sealing Tested to UL 441 Section 27 "Rain Test" and TAS 100-95 "Wind Driven Rain Test" by Intertek. Ratings applicable for composition shingle roofs having slopes between 2:12 and 12:12.

### UL 2703

Conforms to UL 2703 Mechanical and Bonding Requirements. See Flush Mount Install Manual for full ratings.

# CHECKLIST

## PRE-INSTALLATION

- Verify module compatibility. See [Page 13](#) for info.

## TOOLS REQUIRED

- Cordless Drill (non-impact)
- Impact Driver (for lag bolts)
- Torque Wrench (0-250 in-lbs)
- 5/16" Socket
- 7/16" Socket
- 1/2" Socket
- String Line

## TORQUE VALUES

- FlashFoot2 Lag Bolts (7/16" Socket): Fully Seat
- Bonded Splice Screws (5/16" Socket): 20 in-lbs
- Grounding Lug Nuts (7/16" Socket): 80 in-lbs
- Grounding Lug Terminal Screws (7/16" Socket): 20 in-lbs
- Universal Fastening Object (7/16" Socket): 80 in-lbs
- Expansion Joint Nuts (7/16" Socket): 80 in-lbs
- Flush Standoffs (1/2" Socket): 132 in-lbs
- Microinverter Kit Nuts (7/16" Socket): 80 in-lbs
- Frameless Module Kit Nuts (7/16" Socket): 80 in-lbs
- 3/8" Bonding Hardware Nuts (7/16" Socket): 250 in-lbs
- All Tile Hook Lags (7/16" Socket): Fully Seat
- All Tile Hook Carriage Bolts (7/16" Socket): 132 in-lbs
- Knockout Tile Lags (1/2" Socket): Fully Seat
- Knockout Tile Nuts (1/2" Socket): 132 in-lbs
- Flat Roof Attachment Nuts (9/16" Socket): 250 in-lbs

💡 If using FlashVue or previous version of: FlashFoot, Integrated Grounding Mid Clamps, Grounding Lug, End Clamps, and Expansion Joints please refer to Alternate Components Addendum (Version 1.3).

## IRONRIDGE COMPONENTS

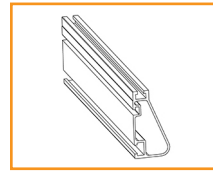

XR Rail

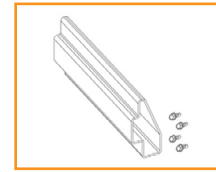

Bonded Splice

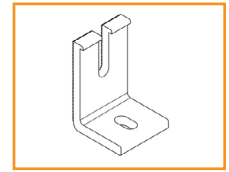

L-Foot

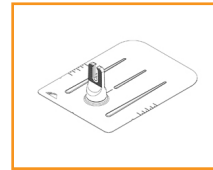

FlashFoot2

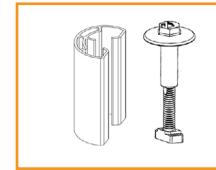

UFO and Stopper Sleeve

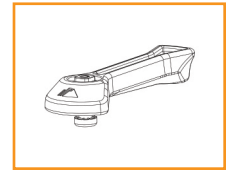

CAMO

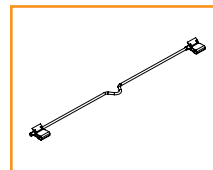

8" Bonding Jumper

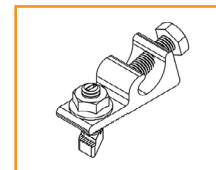

Grounding Lug

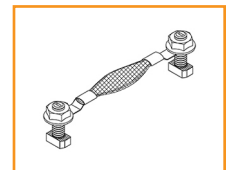

Expansion Joint



End Cap



Wire Clip

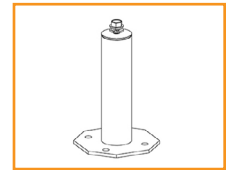

Flush Standoff

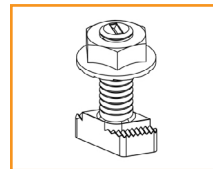

Microinverter Kit

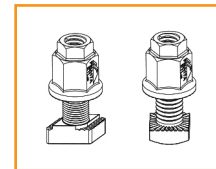

3/8" Bonding Hardware

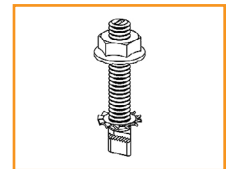

Frameless Module Kit

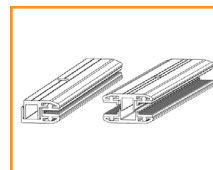

Frameless End/Mid Clamp

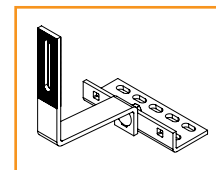

All Tile Hook

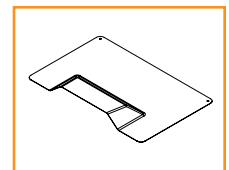

All Tile Hook Flashing

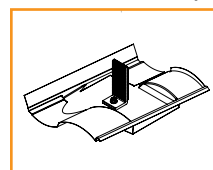

Knockout Tile

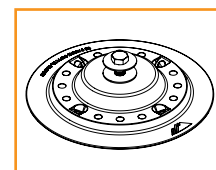

Flat Roof Attachment

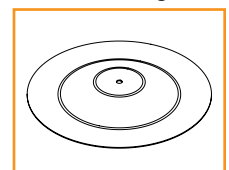

Membrane Flashing

# D223NRB

Safety Switch , 100A, Fusible, Cartridge (Class H, K or R), 2-Pole



by Schneider Electric

List Price \$480.00 USD

Availability **Stock Item: This item is normally stocked in our distribution facility.**

## Technical Characteristics

Terminal Type	Lugs
Type of Duty	General Duty
Maximum Voltage Rating	240VAC
Wire Size	#12 to #1/0 AWG(Al) - #14 to #1/0 AWG(Cu)
Depth	6.50 Inches
Height	17.50 Inches
Width	8.50 Inches
Action	Single Throw
Ampere Rating	100A
Approvals	UL Listed File: E2875
Enclosure Rating	NEMA 3R
Enclosure Type	Rainproof and Sleet/Ice proof (Indoor/Outdoor)
Enclosure Material	Galvannealed Steel
Factory Installed Neutral	Yes
Fuse Type	Cartridge (Class H, K or R)
Disconnect Type	Fusible
Short Circuit Current Rating	100kA (max. depending on fuse type)
Mounting Type	Surface
Number of Poles	2-Pole

## Shipping and Ordering

Category	00106 - Safety Switch, General Duty, 30 - 200 Amp, NEMA3R
Discount Schedule	DE1A
GTIN	00785901460701
Package Quantity	1
Weight	15.46 lbs.
Availability Code	Stock Item: This item is normally stocked in our distribution facility.
Returnability	Y
Country of Origin	US

As standards, specifications, and designs change from time to time, please ask for confirmation of the information given in this document.

# Product data sheet

## Characteristics

# QO112L125PG

QO LoadCenter, PoN, main lugs, 125 A, 1 PH,  
12 SP, NEMA1, gndbar

Product availability: Stock - Normally stocked in distribution facility

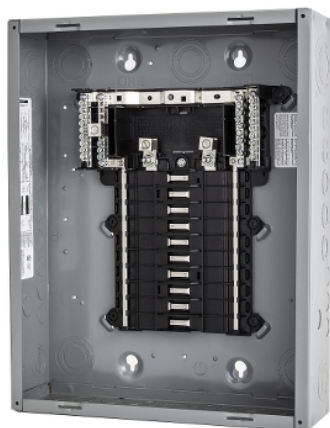

### Main

Product	Load Center
Marketing Trade Name	QO
Provided equipment	Grounding bar

### Complementary

Load Center Type	Main lugs
Line Rated Current	125 A
Number of spaces	12
Short Circuit Current Rating	65 kA
Maximum Number of Single Pole Circuits	12
Maximum Number of Tandem Breakers	12
Number of Phases	1 phase
Box number	6
Height	455.17 mm (17.92 in)
Width	361.95 mm (14.25 in)
Depth	95.25 mm (3.75 in)

### Environment

Enclosure Rating	NEMA 1
Ambient air temperature for operation	23 °F (-5 °C) 104 °F (40 °C)

### Ordering and shipping details

Category	10003 - QO PON 1PH LC,12-60 CKT, ML N1
Discount Schedule	DE3A
GTIN	00785901588382
Package weight(Lbs)	0.45 kg (1 lb(US))
Returnability	Yes
Country of origin	US

The information provided in this documentation contains general descriptions and/or technical characteristics of the performance of the products contained herein. This documentation is not intended as a substitute for and is not to be used for determining suitability or reliability of these products for specific user applications. It is the duty of any such user or integrator to perform the appropriate and complete risk analysis, evaluation and testing of the products with respect to the relevant specific application or use thereof. Neither Schneider Electric Industries SAS nor any of its affiliates or subsidiaries shall be responsible or liable for misuse of the information contained herein.



Product availability: Stock - Normally stocked in distribution facility



### Main

Product or component type	Miniature circuit-breaker
Range of product	QOU
Circuit breaker type	Standard
Circuit breaker application	HACR and Switching Duty rated

### Complementary

Line Rated Current	30 A
Number of Poles	2P
Interrupt Rating	10 KA 120/240 V AC 10 KA 120 V AC 5 kA 48 V DC
Electrical connection	Slotted box lugs, line side Slotted box lugs, load side
[Ue] rated operational voltage	120/240 V AC 120 V AC 48 V DC
Mounting mode	Unit mount
AWG gauge	AWG 14...AWG 2 aluminium/copper
Height	102.87 mm (4.05 in)
Depth	74.93 mm (2.95 in)
Width	38.10 mm (1.5 in)
Tightening torque	5.08 N.m (45 lbf.in) AWG 14...AWG 2)

### Environment

Product certifications	IEC CSA UL listed
------------------------	-------------------------

### Ordering and shipping details

Category	00900 - QOU BREAKERS & SWITCH
Discount Schedule	DE2
GTIN	00785901418719
Package weight(Lbs)	0.34 kg (0.76 lb(US))
Returnability	Yes
Country of origin	MX



## Offer Sustainability

Sustainable offer status	Green Premium product
REACH Regulation	<a href="#">REACH Declaration</a>
EU RoHS Directive	Compliant <a href="#">EU RoHS Declaration</a>
Mercury free	Yes
RoHS exemption information	<a href="#">Yes</a>
China RoHS Regulation	<a href="#">China RoHS Declaration</a>
Environmental Disclosure	<a href="#">Product Environmental Profile</a>
Circularity Profile	No need of specific recycling operations
Halogen content performance	Halogen free product

## Contractual warranty

Warranty	18 months
----------	-----------



Product availability: Stock - Normally stocked in distribution facility



### Main

Product or component type	Miniature circuit-breaker
Range of product	QOU
Circuit breaker type	Standard
Circuit breaker application	HACR and Switching Duty rated

### Complementary

Line Rated Current	60 A
Number of Poles	2P
Interrupt Rating	10 KA 120/240 V AC 10 KA 120 V AC 5 kA 48 V DC
Electrical connection	Slotted box lugs, line side Slotted box lugs, load side
[Ue] rated operational voltage	120/240 V AC 120 V AC 48 V DC
Mounting mode	Unit mount
AWG gauge	AWG 14...AWG 2 aluminium/copper
Height	102.87 mm (4.05 in)
Depth	74.93 mm (2.95 in)
Width	38.10 mm (1.5 in)
Tightening torque	5.08 N.m (45 lbf.in) AWG 14...AWG 2)

### Environment

Product certifications	UL listed CSA IEC
------------------------	-------------------------

### Ordering and shipping details

Category	00900 - QOU BREAKERS & SWITCH
Discount Schedule	DE2
GTIN	00785901418801
Package weight(Lbs)	0.36 kg (0.8 lb(US))
Returnability	Yes
Country of origin	MX

## Offer Sustainability

Sustainable offer status	Green Premium product
REACH Regulation	<a href="#">REACH Declaration</a>
EU RoHS Directive	Compliant <a href="#">EU RoHS Declaration</a>
Mercury free	Yes
RoHS exemption information	<a href="#">Yes</a>
China RoHS Regulation	<a href="#">China RoHS Declaration</a>
Environmental Disclosure	<a href="#">Product Environmental Profile</a>
Circularity Profile	No need of specific recycling operations
Halogen content performance	Halogen free product

## Contractual warranty

Warranty	18 months
----------	-----------

# SolaDeck

PV ROOF-MOUNT ENCLOSURE

**INTRODUCED AT  
*SOLAR POWER 2007***



**UL50 Type 3R Enclosure • Stamped 18 gauge gal. steel • Powder coated finish • Weather tight**



## **Enclosure Includes:**

- Dual ground lug
- Universal DIN rail
- 1/2", 3/4" & 1" knockouts
- Wire strain relief clip
- Complete hardware package

## **PV Roof-Mount Combiner/Enclosure**

### **Benefits**

- The ability to prep the building is now possible
- Replaces several parts used today
- Provides professional looking install
- Saves time on install
- Allows for easy access
- Guaranteed seal to roof
- Low profile design

***For product information contact us at  
(866) 367-7782***

**[www.commdeck.com](http://www.commdeck.com)**



RSTC Enterprises, Inc  
2219 Heimstead Road  
Eau Claire, WI 54703  
1 (866) 367 - 7782



## **SolaDeck Part # 780**

### **Specifications:**

**18 Gauge Steel Base (1) and Cover (2)**  
**Pre Punched 7 holes in base (1) for roof deck**  
**Pre Punched 4 holes in base (1) and cover (2) for match**  
**Draw Process both parts**  
**Powder Coated to withstand 1000 hours Salt Spray (Primer Gray)**  
**High UV resistance**  
**15" x 15" flashing dimension**  
**Cavity dimension 8"W x 9" L x 2.5"D**  
**Approx. 162 Cubic inch equipment cavity**  
**Norloked steel base plate (3) to drawn base (2)**  
**Three knockout locations .5", .75" and 1"**  
**3" DIN rail installed**  
**Grounding Lug- Installed (In Equipment Cavity)**  
**Wire Strain Relief Clip –Installed (In Equipment Cavity)**  
**Hardware pack withstands 500 hours Salt Spray**  
**7 - 2" Trusshead Screws**  
**4 - .5" 8-32 thread cutting screws**  
**4 - #10 Bonded Seal washers**  
**1 – Foam closed Cell Seal**  
**ETL Listed UL50 Type 3R**

**Total Weight 6.9 pounds each**

### **Packaging:**

**Individually bagged and boxed**  
**Box dimension 15.5"w x 16" L x 3" D**  
**White Carton labeled with Cut out template**  
**Print One Color - Black**

**Master Cartons of 6 Units each**  
**Master Carton dimension 18.75"x16"x16.375"**  
**Master Carton Weight – 42 pounds**  
**18 Master Cartons per skid Approx 800 pounds with skid**