



Scott E. Wyssling, PE, PP, CME

Wyssling Consulting
76 North Meadowbrook Drive
Alpine, UT 84004
office (201) 874-3483
swyssling@wysslingconsulting.com

September 28, 2020

1505 King Street Ext. #114
Suite 114
Palmetto State Solar
Charleston, NC 29405

Re: Engineering Services
Sharpe Residence
641 Avery Pond Drive, Fuquay-Varina, NC
7.600 kW System

To Whom it May Concern,

Pursuant to your request, we have reviewed the following information regarding solar panel installation on the roof of the above referenced home:

1. Site Visit/Verification Form prepared by a Palmetto State Solar representative identifying specific site information including size and spacing of rafters for the existing roof structure.
2. Design drawings of the proposed system including a site plan, roof plan and connection details for the solar panels. This information was prepared by Palmetto State Solar and will be utilized for approval and construction of the proposed system.
3. Photographs of the interior and exterior of the roof system identifying existing structural members and their conditions.

Based on the above information we have evaluated the structural capacity of the existing roof system to support the additional loads imposed by the solar panels and have the following comments related to our review and evaluation:

Description of Residence:

The existing residence is typical wood framing construction with the roof system consisting of truss system with all chords constructed of 2 x 4 dimensional lumber at 24" on center. The attic space is unfinished and photos indicate that there was free access to visually inspect the size and condition of the roof rafters. All wood material utilized for the roof system is assumed to be Doug-Fir #2 or better with standard construction components. The existing roofing material consists of composite asphalt shingles. Photos of the dwelling also indicate that there is a permanent foundation.

A. Loading Criteria Used

- 117 MPH wind loading based on ASCE 7-10 Exposure Category "C" at a slope of 22 degrees
- 7 PSF = Dead Load roofing/framing Live Load = 20 PSF Snow Load = 15 PSF
- 3 PSF = Dead Load solar panels/mounting hardware

Total Dead Load = 10 PSF

The above values are within acceptable limits of recognized industry standards for similar structures in accordance with the North Carolina Residential Code (2018 IRC). Analysis performed of the existing roof structure utilizing the above loading criteria indicates that the existing rafters will support the additional panel loading without damage, if installed correctly.

B. Solar Panel Anchorage

1. The solar panels shall be mounted in accordance with the most recent "*Unirac Installation Manual*", which can be found on the UniRac website (<http://unirac.com/>). If during solar panel installation, the roof framing members appear unstable or deflect non-uniformly, our office should be notified before proceeding with the installation.
2. Maximum allowable pullout per lag screw is 235 lbs/inch of penetration as identified in the National Design Standards (NDS) of timber construction specifications for Doug-Fir (North Lumber) *assumed*. Based on our evaluation, the pullout value, utilizing a penetration depth of 2 ½", is less than what is allowable per connection and therefore is adequate. Based on the variable factors for the existing roof framing and installation tolerances, using a thread depth of 2 ½" with a minimum size of 5/16" lag screw per attachment point for panel anchor mounts should be adequate with a sufficient factor of safety.
3. Considering the roof slopes, the size, spacing, condition of roof, the panel supports shall be placed no greater than 48" o/c.
4. Panel supports connections shall be staggered to distribute load to adjacent trusses.

Based on the above evaluation, it is the opinion of this office that with appropriate panel anchors being utilized the roof system will adequately support the additional loading imposed by the solar panels. This evaluation is in conformance with the North Carolina Residential Code and the 2018 IRC, current industry and standards, and based on information supplied to us at the time of this report.

Should you have any questions regarding the above or if you require further information do not hesitate to contact me.

Very truly yours,

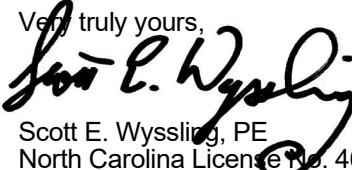

Scott E. Wyssling, PE
North Carolina License No. 46546





CONTRACTOR INFORMATION:
 PALMETTO
 Address: 1505 King St,
 EXT ST 114
 Charleston SC 29405

SITE INFORMATION:
 Chris Sharpe
 641 Avery Pond Dr, Fuquay-varina, NC 27526
 MAX CONTINUOUS AC SYSTEM SIZE: 7.6 kW AC
 DC SYSTEM SIZE: 8.04 kW DC
 Lat, Long: 35.4965269351312, -78.8217472042297
 (24) LG LG335N1K-V5 PV MODULES
 (1) SolarEdge SE7600H-US (240V) INVERTER
 Duke Energy NC

DATE: September 25, 2020
 PAGE: PV01 SHEET NAME: COVER PAGE
 DRAWN BY: SoloCAD

AERIAL VIEW:

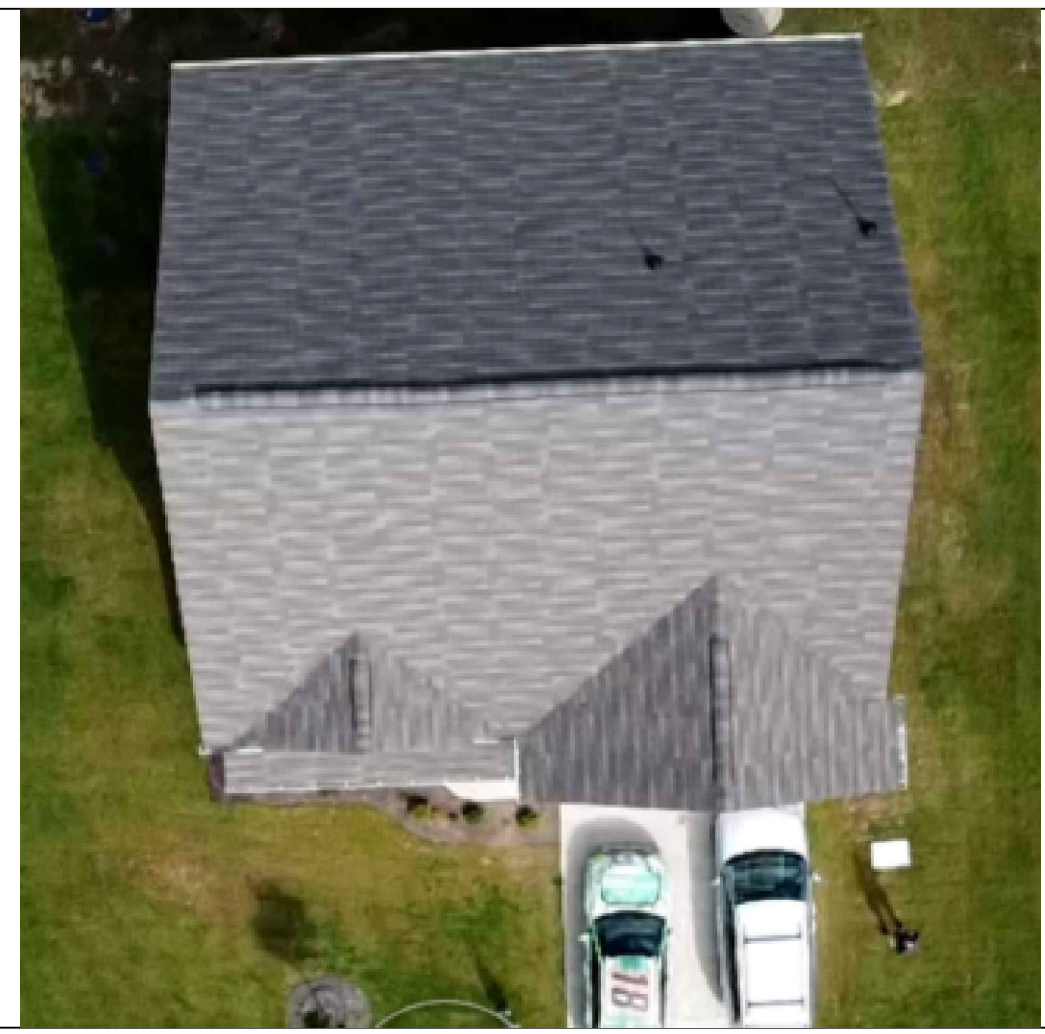

MAPS VIEW:



SHEET INDEX:

- PV01 COVER PAGE
- PV02 PROPERTY PLAN
- PV03 ROOF PLAN
- PV04 ROOF ATTACHMENTS + BOM
- PV05 MOUNTING DETAIL
- PV06 ELECTRICAL DIAGRAM
- PV07 LABELS
- PV08 PLACARD
- PV09 SITE PHOTOS



GENERAL NOTES:

1. INSTALLATION OF SOLAR PHOTOVOLTAIC SYSTEM SHALL BE IN ACCORDANCE WITH NEC ARTICLE 690, AND ALL OTHER APPLICABLE NEC CODES WHERE NOTED OR EXISTING.
2. PROPER ACCESS AND WORKING CLEARANCE AROUND EXISTING AND PROPOSED ELECTRICAL EQUIPMENT WILL COMPLY WITH NEC ARTICLE 110.
3. ALL WIRES, INCLUDING THE GROUNDING ELECTRODE CONDUCTOR SHALL BE PROTECTED FROM PHYSICAL DAMAGE IN ACCORDANCE WITH NEC ARTICLE 250
4. THE PV MODULES ARE CONSIDERED NON-COMBUSTIBLE; THIS SYSTEM IS UTILITY INTERACTIVE PER UL 1741 AND DOES NOT INCLUDE STORAGE BATTERIES OR OTHER ALTERNATIVE STORAGE SOURCES.
5. ALL DC WIRES SHALL BE SIZED ACCORDING TO [NEC 690.8]
6. DC CONDUCTORS SHALL BE WITHIN PROTECTED RACEWAYS IN ACCORDANCE WITH [NEC 690.31]
7. ALL SIGNAGE TO BE PLACED IN ACCORDANCE WITH LOCAL JURISDICTIONAL BUILDING CODE.

DESCRIPTION OF DESIGN:

INSTALLATION OF GRID -TIED, UTILITY INTERACTIVE PHOTOVOLTAIC SYSTEM

EQUIPMENT:

MAX CONTINUOUS AC SYSTEM SIZE: 7.6 kW AC
 DC SYSTEM SIZE: 8.04 kW DC
 (24) LG LG335N1K-V5 PV MODULES
 (1) SolarEdge SE7600H-US (240V) INVERTER
 RACKING: Unirac - 48" O.C.



APPLICABLE GOVERNING CODES:

- 2017 NEC
- 2018 IRC
- 2018 IFC
- 2018 IBC
- 2018 NC RBC

SITE SPECIFICATIONS:

OCCUPANCY: R-3
 ZONING: RESIDENTIAL









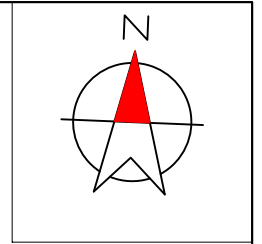



CONTRACTOR INFORMATION:
PALMETTO
 Address: 1505 King St,
 EXT ST 114
 Charleston SC 29405

SITE INFORMATION:
 Chris Sharpe
 641 Avery Pond Dr, Fuquay-varina, NC 27526
 MAX CONTINUOUS AC SYSTEM SIZE: 7.6 kW AC
 DC SYSTEM SIZE: 8.04 kW DC
 Lat, Long: 35.4965269351312, -78.8217472042297
 (24) LG LG335N1K-V5 PV MODULES
 (1) SolarEdge SE7600H-US (240V) INVERTER
 Duke Energy NC

DATE: September 25, 2020
 PAGE: PV02 SHEET NAME: PROPERTY PLAN
 DRAWN BY: SoloCAD SCALE: 1" = 25.75'



EQUIPMENT LEGEND:

-  UTILITY METER
-  MAIN SERVICE PANEL
-  VISIBLE, LOCKABLE, LABELED AC DISCONNECT
-  METER SOCKET (FOR UTILITY PV METER)
-  INVERTER
-  COMBINER BOX
-  LOAD CENTER
-  FIRE ACCESS PATHWAY (3' TYP)
-  PROPERTY LINE
-  BATTERY(IES)

VISIBLE, LOCKABLE,
 LABELED AC DISCONNECT
 LOCATED WITHIN 10'
 OF UTILITY METER

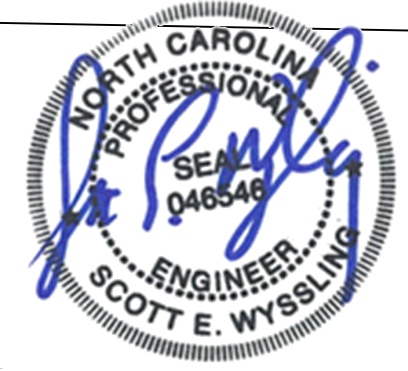
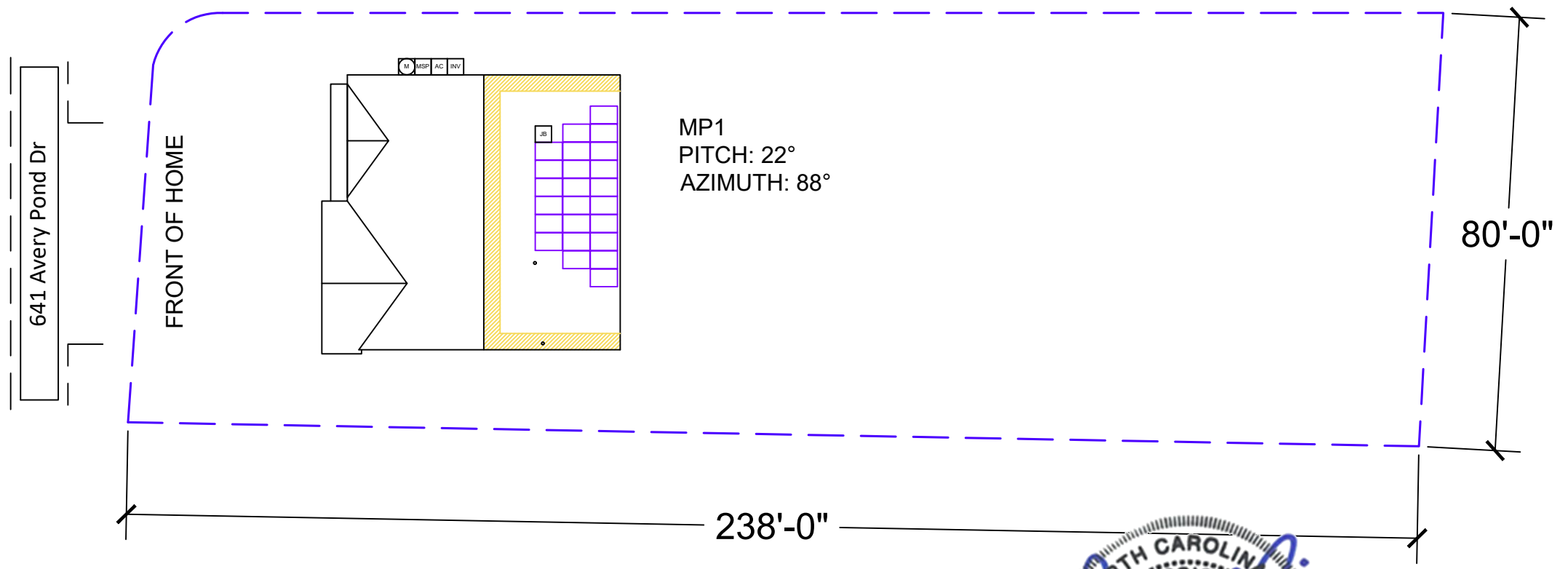



CONTRACTOR INFORMATION:
 PALMETTO
 Address: 1505 King St,
 EXT ST 114
 Charleston SC 29405

SITE INFORMATION:
 Chris Sharpe
 641 Avery Pond Dr, Fuquay-varina, NC 27526
 MAX CONTINUOUS AC SYSTEM SIZE: 7.6 kW AC
 DC SYSTEM SIZE: 8.04 kW DC
 Lat, Long: 35.4965269351312, -78.8217472042297
 (24) LG LG335N1K-V5 PV MODULES
 (1) SolarEdge SE7600H-US (240V) INVERTER
 Duke Energy NC

DATE: September 25, 2020
 PAGE: PV03 SHEET NAME: ROOF PLAN
 DRAWN BY: SoloCAD

EQUIPMENT LEGEND:

	UTILITY METER
	MAIN SERVICE PANEL
	VISIBLE, LOCKABLE, LABELED AC DISCONNECT
	METER SOCKET (FOR UTILITY PV METER)
	INVERTER
	COMBINER BOX
	LOAD CENTER
	FIRE ACCESS PATHWAY (3' TYP)
	BATTERY(IES)

VISIBLE, LOCKABLE, LABELED AC DISCONNECT LOCATED WITHIN 10' OF UTILITY METER

FRONT OF HOME

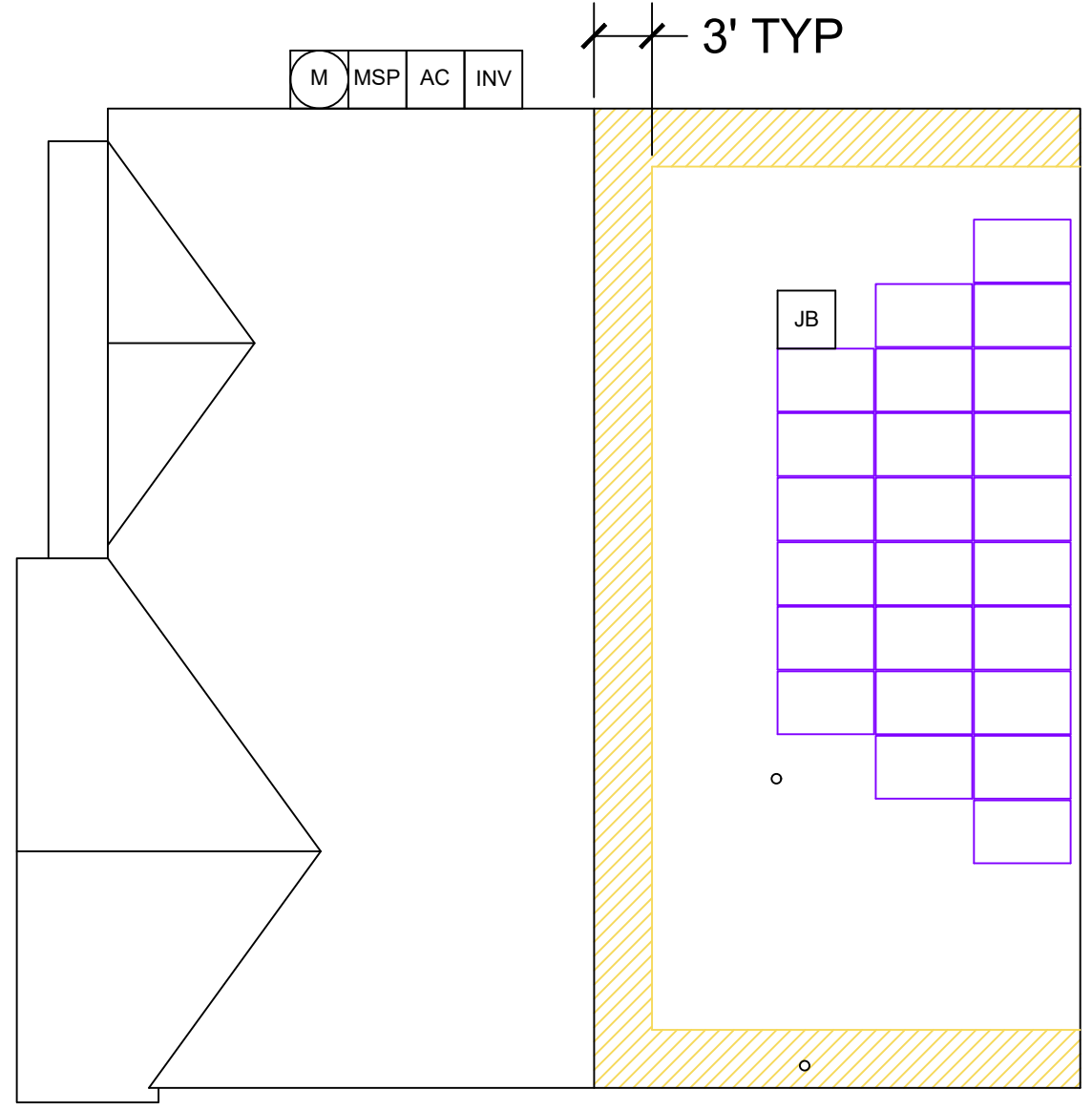

MP1
 PITCH: 22°
 AZIMUTH: 88°



CONTRACTOR INFORMATION:
PALMETTO
 Address: 1505 King St,
 EXT ST 114
 Charleston SC 29405

SITE INFORMATION:
 Chris Sharpe
 641 Avery Pond Dr, Fuquay-varina, NC 27526
 MAX CONTINUOUS AC SYSTEM SIZE: 7.6 kW AC
 DC SYSTEM SIZE: 8.04 kW DC
 Lat, Long: 35.4965269351312, -78.8217472042297
 (24) LG LG335N1K-V5 PV MODULES
 (1) SolarEdge SE7600H-US (240V) INVERTER
 Duke Energy NC

M MSP AC INV

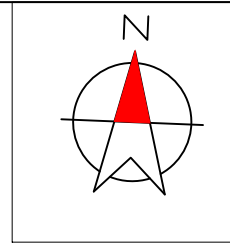
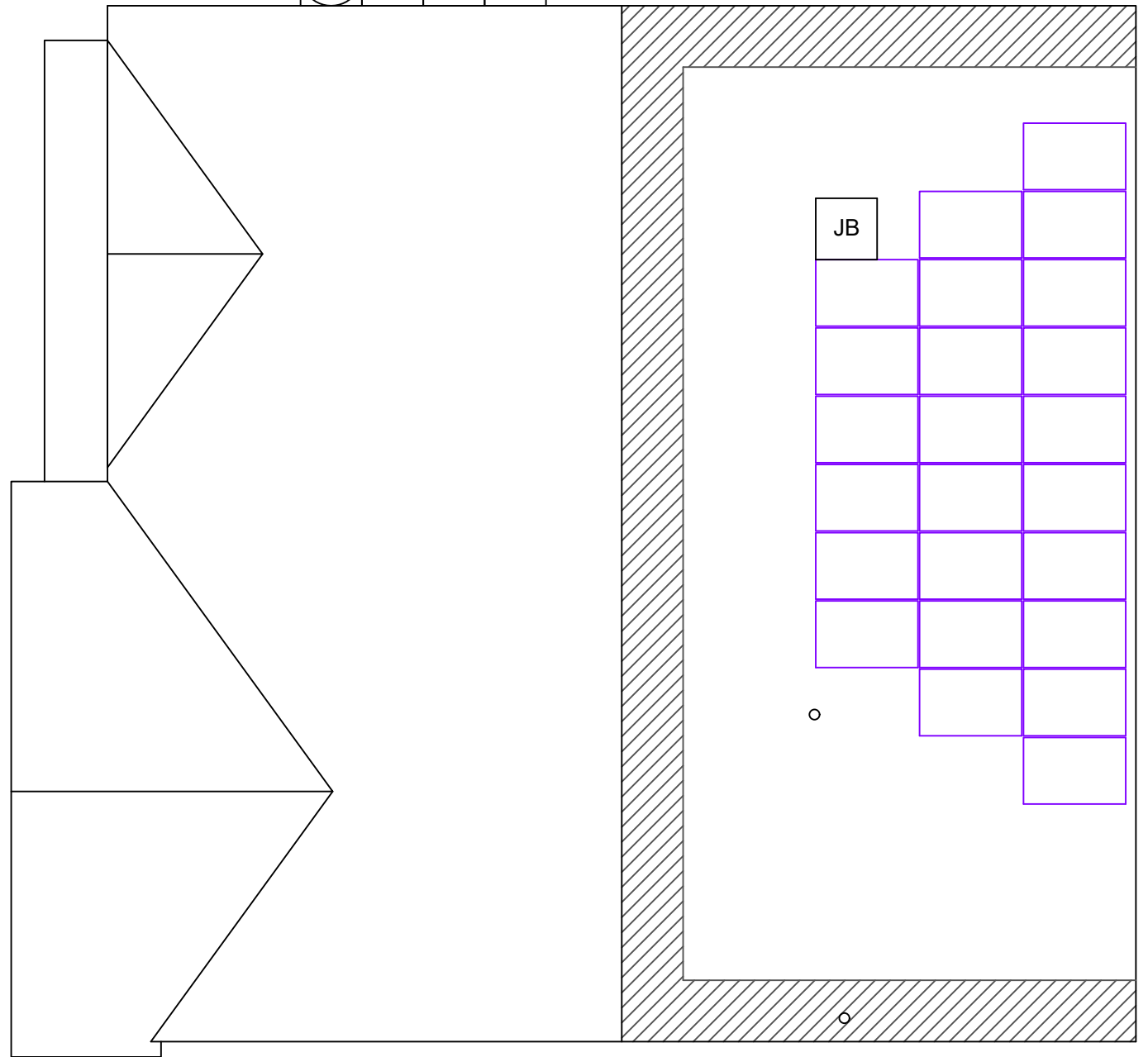

EQUIPMENT INFORMATION:		ROOF INFO:		PHOTOVOLTAIC ARRAY STRUCTURAL CRITERIA:	
RAIL MANUFACTURER	Unirac	ROOF TYPE	asphalt_shingle	ROOF ATTACHMENT COUNT:	46
RAIL PART NUMBER	SM	ROOF FRAMING	traditional_framing	PV MODULE COUNT:	24
ATTACHMENTS	Unirac - FLASHKIT PRO	RAFTER/TOP CHORD SIZE	2x4	ARRAY AREA:	MODULE COUNT * 18.06ft ² = 433.44
ATTACHMENT QTY	46	RAFTER/TOP CHORD SPACING	24	ROOF AREA:	2740 ft ²
MIDCLAMP QTY	42	ATTACHMENT SPACING	48	PERCENT OF ROOF COVERED:	16%
ENDCLAMP QTY	12			ARRAY WEIGHT:	MODULE COUNT * 50lbs = 1200
SPLICE QTY	8			DISTRIBUTED LOAD:	ARRAY LBS/ATTACHMENTS = 26.09
				POINT LOAD: (lbs/ft ²)	(ARRAY) WEIGHT/AREA = 2.77 lbs/ft ²

DATE: September 25, 2020
 PAGE: PV04 SHEET NAME: ROOF ATTACHMENTS + BOM
 DRAWN BY: SoloCAD



CONTRACTOR INFORMATION:
PALMETTO
 Address: 1505 King St,
 EXT ST 114
 Charleston SC 29405

SITE INFORMATION:
 Chris Sharpe
 641 Avery Pond Dr, Fuquay-varina, NC 27526
 MAX CONTINUOUS AC SYSTEM SIZE: 7.6 kW AC
 DC SYSTEM SIZE: 8.04 kW DC
 Lat, Long: 35.4965269351312, -78.8217472042297
 (24) LG LG335N1K-V5 PV MODULES
 (1) SolarEdge SE7600H-US (240V) INVERTER
 Duke Energy NC

DATE: September 25, 2020
 PAGE: PV05 SHEET NAME: MOUNTING DETAIL
 DRAWN BY: SoloCAD

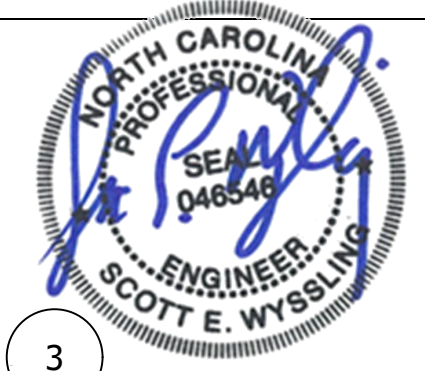
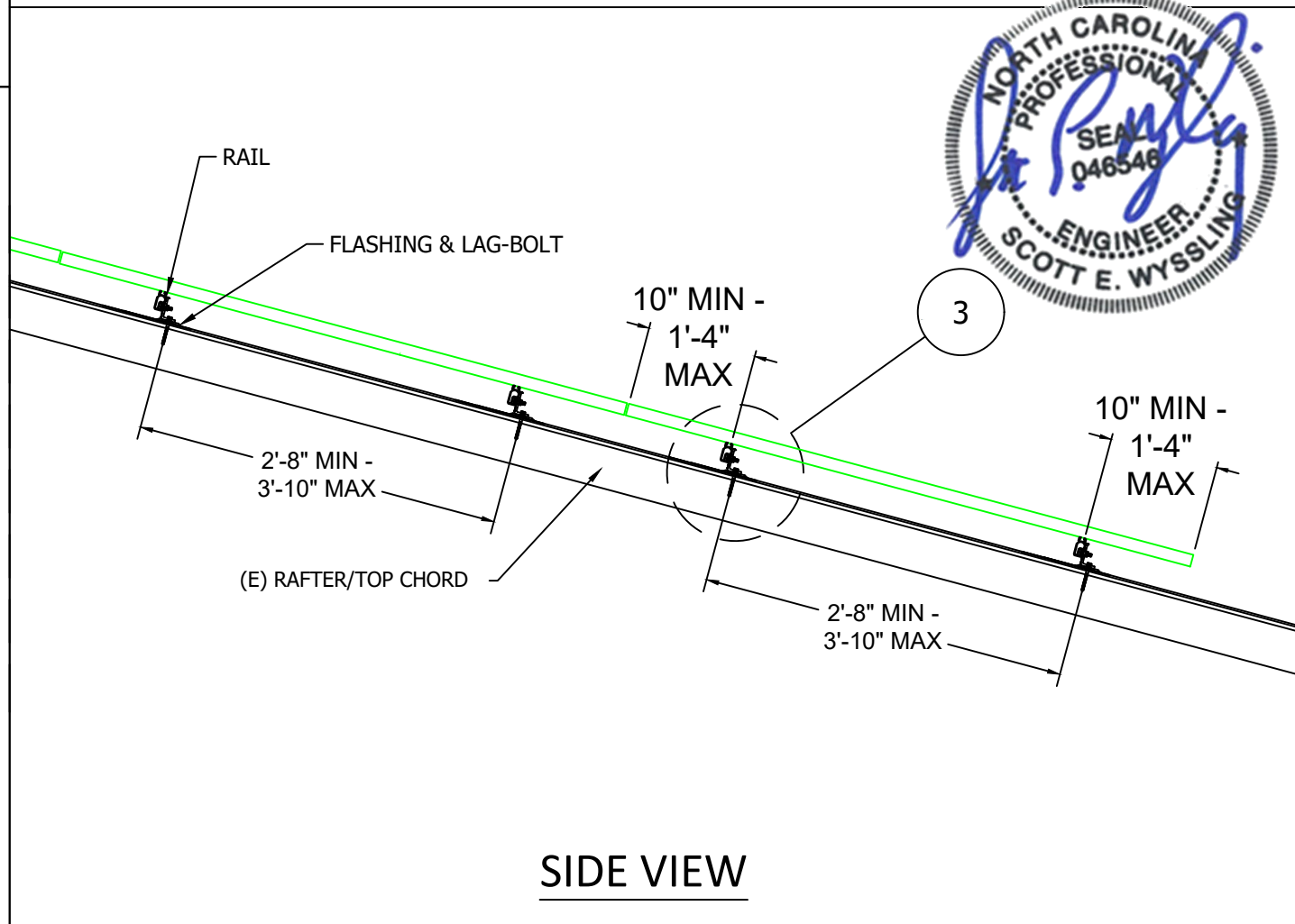
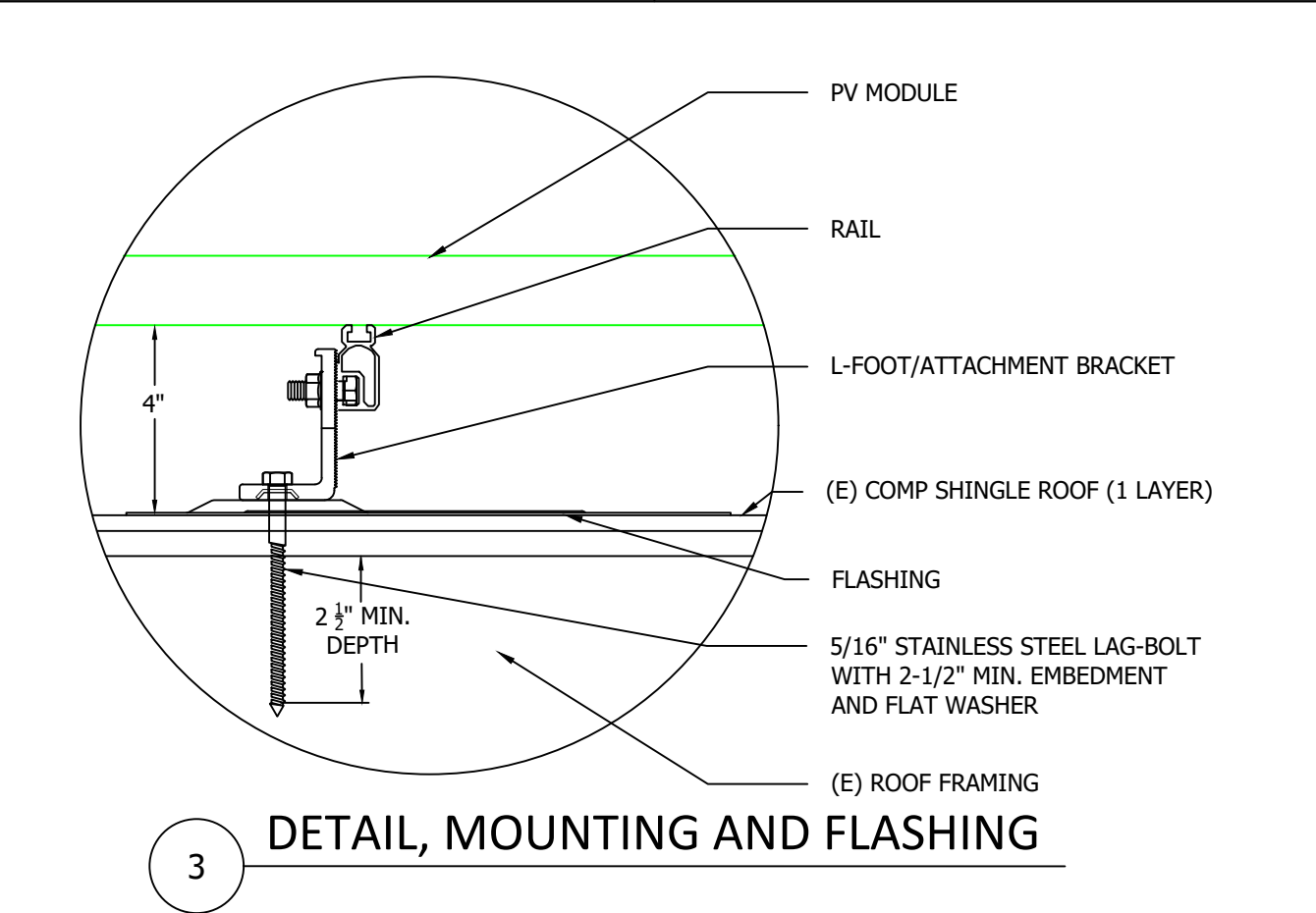
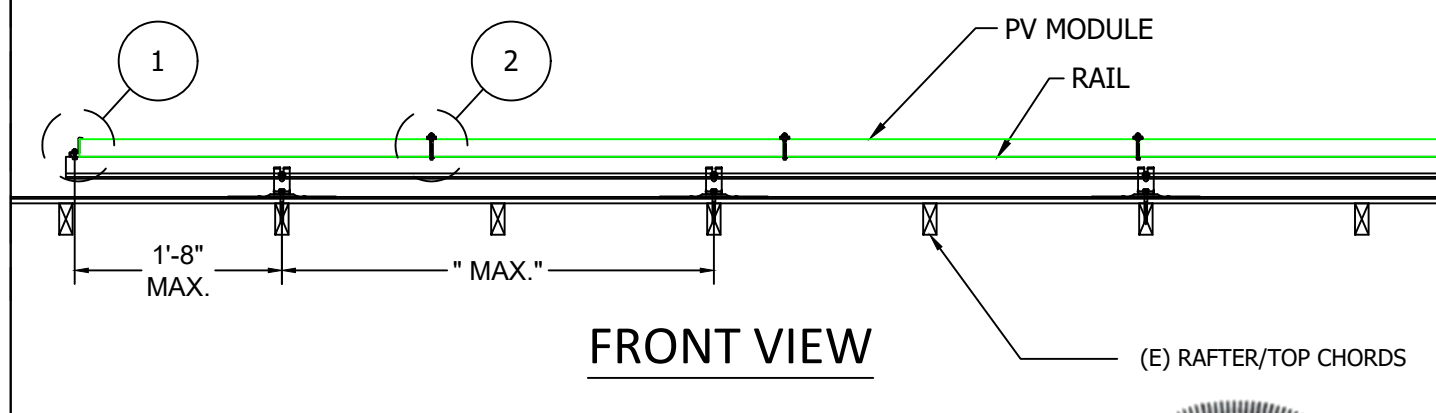
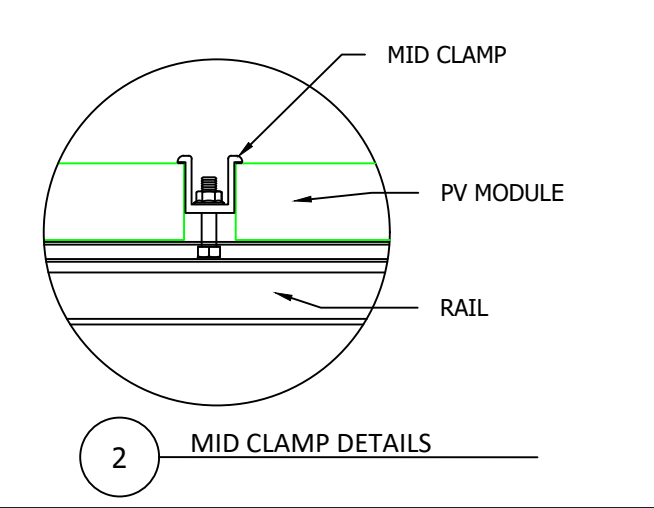
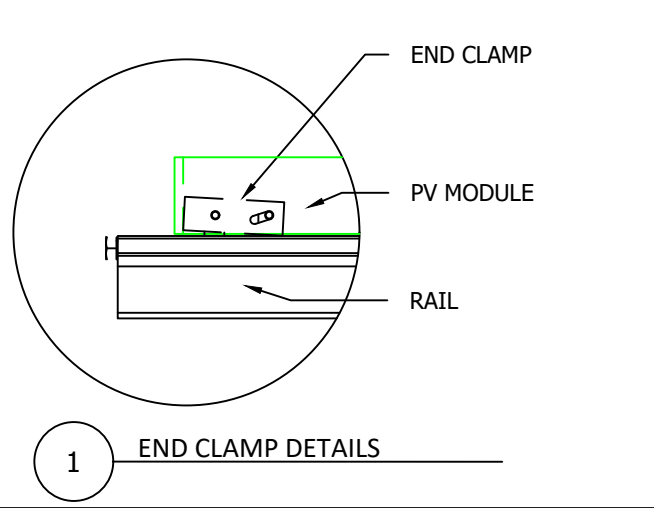

EQUIPMENT INFORMATION:		ROOF INFO:		PHOTOVOLTAIC ARRAY STRUCTURAL CRITERIA:	
RAIL MANUFACTURER	Unirac	ROOF TYPE	asphalt_shingle	ROOF ATTACHMENT COUNT:	46
RAIL PART NUMBER	SM	ROOF FRAMING	traditional_framing	PV MODULE COUNT:	24
ATTACHMENTS	Unirac - FLASHKIT PRO	RAFTER/TOP CHORD SIZE	2x4	ARRAY AREA:	MODULE COUNT * 18.06ft ² = 433.44
ATTACHMENT QTY	46	RAFTER/TOP CHORD SPACING	24	ROOF AREA:	2740 ft ²
MIDCLAMP QTY	42	ATTACHMENT SPACING	48	PERCENT OF ROOF COVERED:	16%
ENDCLAMP QTY	12			ARRAY WEIGHT:	MODULE COUNT * 50lbs = 1200
SPLICE QTY	8			DISTRIBUTED LOAD:	ARRAY LBS/ATTACHMENTS = 26.09
				POINT LOAD: (lbs/ft ²)	(ARRAY) WEIGHT/AREA = 2.77 lbs/ft ²



CONTRACTOR INFORMATION:

PALMETTO
 Address: 1505 King St,
 EXT ST 114
 Charleston SC 29405

SITE INFORMATION:

Chris Sharpe
 641 Avery Pond Dr, Fuquay-varina, NC 27526
 MAX CONTINUOUS AC SYSTEM SIZE: 7.6 kW AC
 DC SYSTEM SIZE: 8.04 kW DC
 Lat, Long: 35.4965269351312, -78.8217472042297
 (24) LG LG335N1K-V5 PV MODULES
 (1) SolarEdge SE7600H-US (240V) INVERTER
 Duke Energy NC

DATE: September 25, 2020

PAGE: PV06 SHEET NAME: ELECTRICAL DIAGRAM

DRAWN BY: SoloCAD

WIRE SCHEDULE

1	(2) PV-WIRE - 10 AWG, USE-2, COPPER (OR CODE APPROVED EQUIVALENT) (1) 6 AWG BARE, COPPER (GROUND)	2	(1) 10 AWG THWN-2, or THHN, or 10/2 NM-B COPPER - (POSITIVE) (1) 10 AWG THWN-2, or THHN, or 10/2 NM-B COPPER - (NEGATIVE) (1) 10 AWG THWN-2, or THHN, or 10/2 NM-B COPPER - (GROUND) (1) 3/4" LIQUID TIGHT OR EMT OR FMC (OR CODE APPROVED EQUIVALENT)	3	(2) 10 AWG THHN/THWN-2, COPPER - (POSITIVE) (2) 10 AWG THHN/THWN-2 COPPER - (NEGATIVE) (1) 10 AWG THHN/THWN-2 (GROUND) CONDUIT: 3/4" LIQUID TIGHT OR EMT (OR CODE APPROVED EQUIVALENT)	4	(1) 8 AWG THWN-2 COPPER - (L1) (1) 8 AWG THWN-2 COPPER - (L2) (1) 8 AWG THWN-2 COPPER - (NEUTRAL) (1) 10 AWG THWN-2 COPPER - (GROUND) (1) CONDUIT: 3/4" LIQUID TIGHT OR EMT (OR CODE APPROVED EQUIVALENT)
----------	--	----------	---	----------	---	----------	---

STRINGS:		SERVICE EQUIPMENT & PV OCPD RATINGS	
STRING 1	12 PV MODULES	MAIN BREAKER RATING	0A
STRING 2	12 PV MODULES	MAIN SERVICE BUS RATING	225A
		PV OCPD RATING	40A
		AC VOLTAGE	240V
		AC DISCONNECT RATING	60A

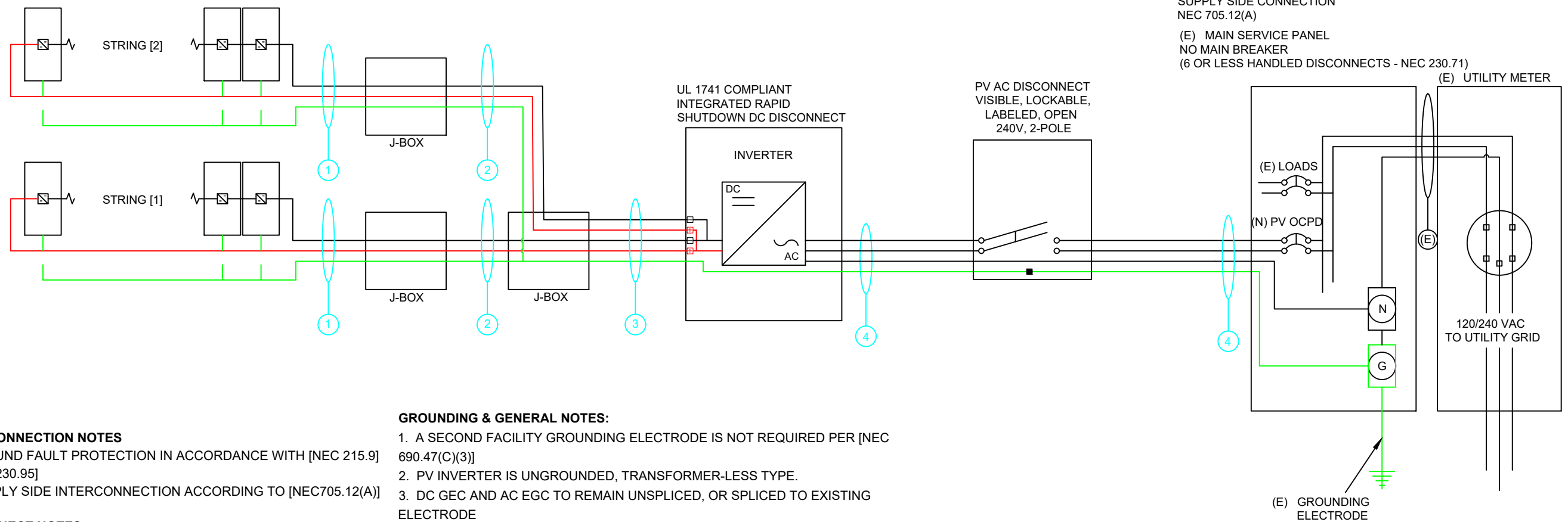

INTERCONNECTION NOTES

- GROUND FAULT PROTECTION IN ACCORDANCE WITH [NEC 215.9] & [NEC 230.95]
- SUPPLY SIDE INTERCONNECTION ACCORDING TO [NEC705.12(A)]

DISCONNECT NOTES

- DISCONNECTING SWITCHES SHALL BE WIRED SUCH THAT WHEN THE SWITCH IS OPENED THE CONDUCTORS REMAINING LIVE ARE CONNECTED TO THE TERMINALS MARKED "LINE SIDE" (TYPICALLY THE UPPER TERMINALS)
- AC DISCONNECT MUST BE ACCESSIBLE TO QUALIFIED UTILITY PERSONNEL, BE LOCKABLE, AND BE A VISIBLE-BREAK SWITCH.

GROUNDING & GENERAL NOTES:

- A SECOND FACILITY GROUNDING ELECTRODE IS NOT REQUIRED PER [NEC 690.47(C)(3)]
- PV INVERTER IS UNGROUNDED, TRANSFORMER-LESS TYPE.
- DC GEC AND AC EGC TO REMAIN UNSPLICED, OR SPLICED TO EXISTING ELECTRODE
- ANY EXISTING WIRING INVOLVED WITH PV SYSTEM CONNECTION THAT IS FOUND TO BE INADEQUATE PER CODE SHALL BE CORRECTED PRIOR TO FINAL INSPECTION.
- JUNCTION BOX QUANTITIES, AND PLACEMENT SUBJECT TO CHANGE IN THE FIELD - JUNCTION BOXES DEPICTED ON ELECTRICAL DIAGRAM REPRESENT WIRE TYPE TRANSITIONS.
- AC DISCONNECT NOTED IN EQUIPMENT SCHEDULE OPTIONAL IF OTHER AC DISCONNECTING MEANS IS LOCATED WITHIN '10' OF SERVICE DISCONNECT.

EQUIPMENT SCHEDULE:

TYPE:	QTY:	DESCRIPTION:	RATING:
MODULES:	(24)	LG LG335N1K-V5	335 W
INVERTERS:	(1)	SolarEdge SE7600H-US (240V)	7600 W
AC DISCONNECT(S):	(1)	PV AC DISCONNECT, 240V, 2-POLE	60 A
DC OPTIMIZERS:	(24)	SolarEdge P340	15 Adc



CONTRACTOR INFORMATION:
 PALMETTO
 Address: 1505 King St,
 EXT ST 114
 Charleston SC 29405

SITE INFORMATION:
 Chris Sharpe
 641 Avery Pond Dr, Fuquay-varina, NC 27526
 MAX CONTINUOUS AC SYSTEM SIZE: 7.6 kW AC
 DC SYSTEM SIZE: 8.04 kW DC
 Lat, Long: 35.4965269351312, -78.8217472042297
 (24) LG LG335N1K-V5 PV MODULES
 (1) SolarEdge SE7600H-US (240V) INVERTER
 Duke Energy NC

DATE: September 25, 2020
 PAGE: PV07 SHEET NAME: LABELS
 DRAWN BY: SoloCAD

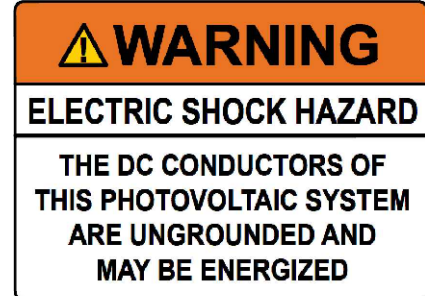

LABEL 1
 AT EACH JUNCTION BOX, COMBINER BOX, DISCONNECT, AND DEVICE WHERE ENERGIZED UNGROUNDED CONDUCTORS MAY BE EXPOSED DURING SERVICE. NEC. 690.35(F)

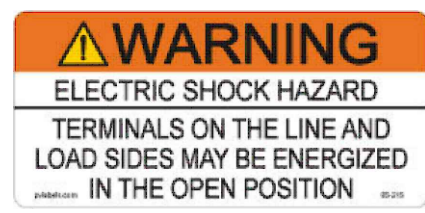

LABEL 2
 FOR PV DISCONNECTING MEANS WHERE ALL TERMINALS OF THE DISCONNECTING MEANS MAY BE ENERGIZED IN THE OPEN POSITION. NEC 690.17(E), NEC 705.22

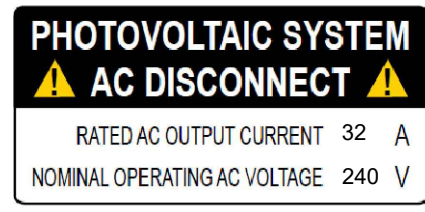

LABEL 4
 AT POINT OF INTERCONNECTION, MARKED AT AC DISCONNECTING MEANS. NEC 690.54, NEC 690.13 (B)

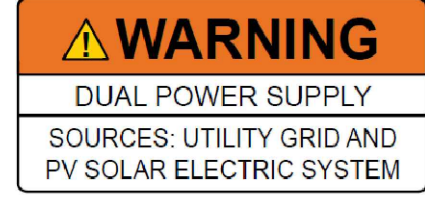

LABEL 5
 AT POINT OF INTERCONNECTION FOR EQUIPMENT CONTAINING OVERCURRENT DEVICES IN CIRCUITS SUPPLYING POWER TO A BUSBAR OR CONDUCTOR SUPPLIED FORM MULTIPLE SOURCES, EACH SERVICE EQUIPMENT AND ALL ELECTRIC POWER PRODUCTION SOURCE LOCATIONS. NEC 705.12(D)(3)

LABEL VALUES:	
DESCRIPTION	VALUE:
DC IMP:	9.72
DC VMP:	34.5
DC VOC:	41.1
DC ISC:	SEE DATASHEET
DC SYSTEM SIZE (W):	8040
AC OPERATING CURRENT:	SEE DATASHEET
AC VOLTAGE:	240

LABEL 6
 AT DIRECT-CURRENT EXPOSED RACEWAYS, CABLE TRAYS, COVERS AND ENCLOSURES OF JUNCTION BOXES, AND OTHER WIRING METHODS; SPACED AT MAXIMUM 10FT SECTION OR WHERE SEPARATED BY ENCLOSURES, WALLS, PARTITIONS, CEILINGS, OR FLOORS. NEC 690.31(G)(3&4)

LABELING NOTES:

1. LABELS CALLED OUT ACCORDING TO ALL COMMON CONFIGURATIONS. ELECTRICIAN TO DETERMINE EXACT REQUIREMENTS IN THE FIELD PER CURRENT NEC AND LOCAL CODES AND MAKE APPROPRIATE ADJUSTMENTS.
2. LABELING REQUIREMENTS BASED ON THE 2017 NATIONAL ELECTRIC CODE, OSHA STANDARD 19010.145, ANSI Z535.
3. MATERIAL BASED ON THE REQUIREMENTS OF THE AUTHORITY HAVING JURISDICTION.
4. LABELS TO BE OF SUFFICIENT DURABILITY TO WITHSTAND THE ENVIRONMENT INVOLVED [NEC 110.21]
5. LABELS TO BE A MINIMUM LETTER HEIGHT OF 3/8", WHITE ON RED BACKGROUND; REFLECTIVE, AND PERMANENTLY AFFIXED [IFC 605.11.1.1]



LABEL 7
 PLACED ADJACENT TO THE BACK-FED BREAKER FROM THE INVERTER IF TIE IN CONSISTS OF LOAD SIDE CONNECTION TO BUSBAR. NEC 705.12(D)(2)(3)(B)

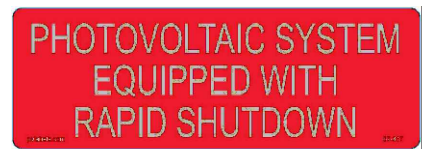

LABEL 8
 SIGN LOCATED AT UTILITY SERVICE EQUIPMENT. NEC 690.56(C)



LABEL 9 (ONLY IF 3 OR MORE SUPPLY SOURCES TO A BUSBAR)
 SIGN LOCATED AT LOAD CENTER IF CONTAINS 3 OR MORE POWER SOURCES. NEC 705.12(D)(2)(3)(C)

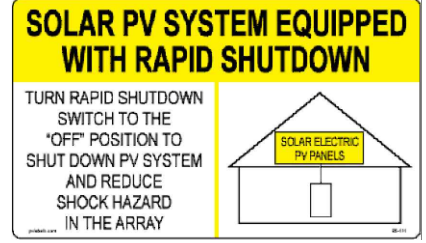

LABEL 10
 FOR PV SYSTEMS THAT SHUT DOWN THE ARRAY AND CONDUCTORS LEAVING THE ARRAY: SIGN TO BE LOCATED ON OR NO MORE THAN 3 FT AWAY FROM SERVICE DISCONNECTING MEANS TO WHICH THE PV SYSTEMS ARE CONNECTED AND SHALL INDICATE THE LOCATION OF ALL IDENTIFIED RAPID SHUTDOWN SWITCHES IF NOT AT THE SAME LOCATION. [NEC 690.56(C)(1)(A)]

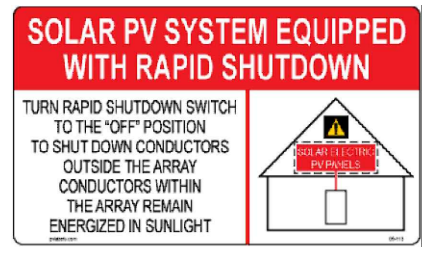

LABEL 11
 FOR PV SYSTEMS THAT ONLY SHUT DOWN CONDUCTORS LEAVING THE ARRAY: SIGN TO BE LOCATED ON OR NO MORE THAN 3 FT AWAY FROM SERVICE DISCONNECTING MEANS TO WHICH THE PV SYSTEMS ARE CONNECTED AND SHALL INDICATE THE LOCATION OF ALL IDENTIFIED RAPID SHUTDOWN SWITCHES IF NOT AT THE SAME LOCATION. [NEC 690.56(C)(1)(B)]

LABELING DIAGRAM:

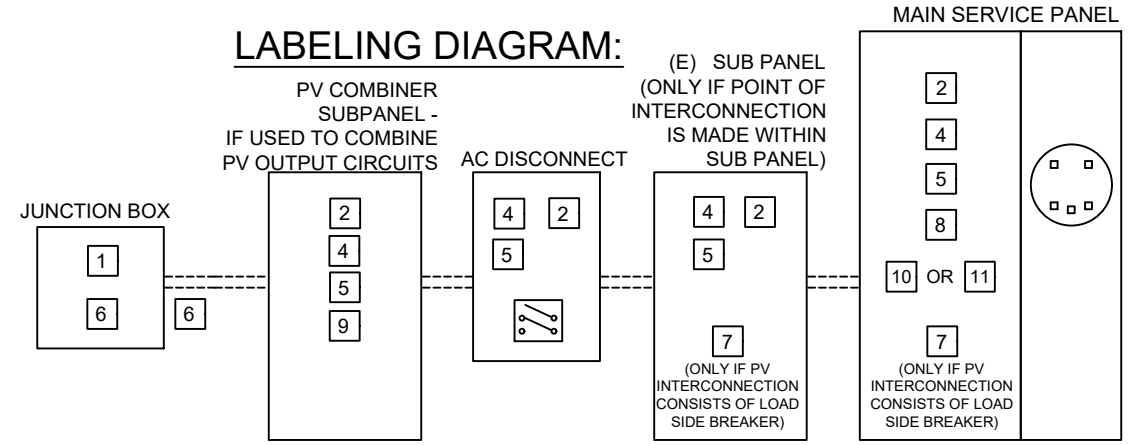

** ELECTRICAL DIAGRAM SHOWN ABOVE IS FOR LABELING PURPOSES ONLY. NOT AN ACTUAL REPRESENTATION OF EQUIPMENT AND CONNECTIONS TO BE INSTALLED. LABEL LOCATIONS PRESENTED MAY VARY DEPENDING ON TYPE OF INTERCONNECTION METHOD AND LOCATION PRESENTED ELECTRICAL DIAGRAM PAGE. **



CONTRACTOR INFORMATION:
PALMETTO
 Address: 1505 King St,
 EXT ST 114
 Charleston SC 29405

SITE INFORMATION:
 Chris Sharpe
 641 Avery Pond Dr, Fuquay-varina, NC 27526
 MAX CONTINUOUS AC SYSTEM SIZE: 7.6 kW AC
 DC SYSTEM SIZE: 8.04 kW DC
 Lat, Long: 35.4965269351312, -78.8217472042297
 (24) LG LG335N1K-V5 PV MODULES
 (1) SolarEdge SE7600H-US (240V) INVERTER
 Duke Energy NC

DATE: September 25, 2020

PAGE: PV08 SHEET NAME: PLACARD

DRAWN BY: SoloCAD

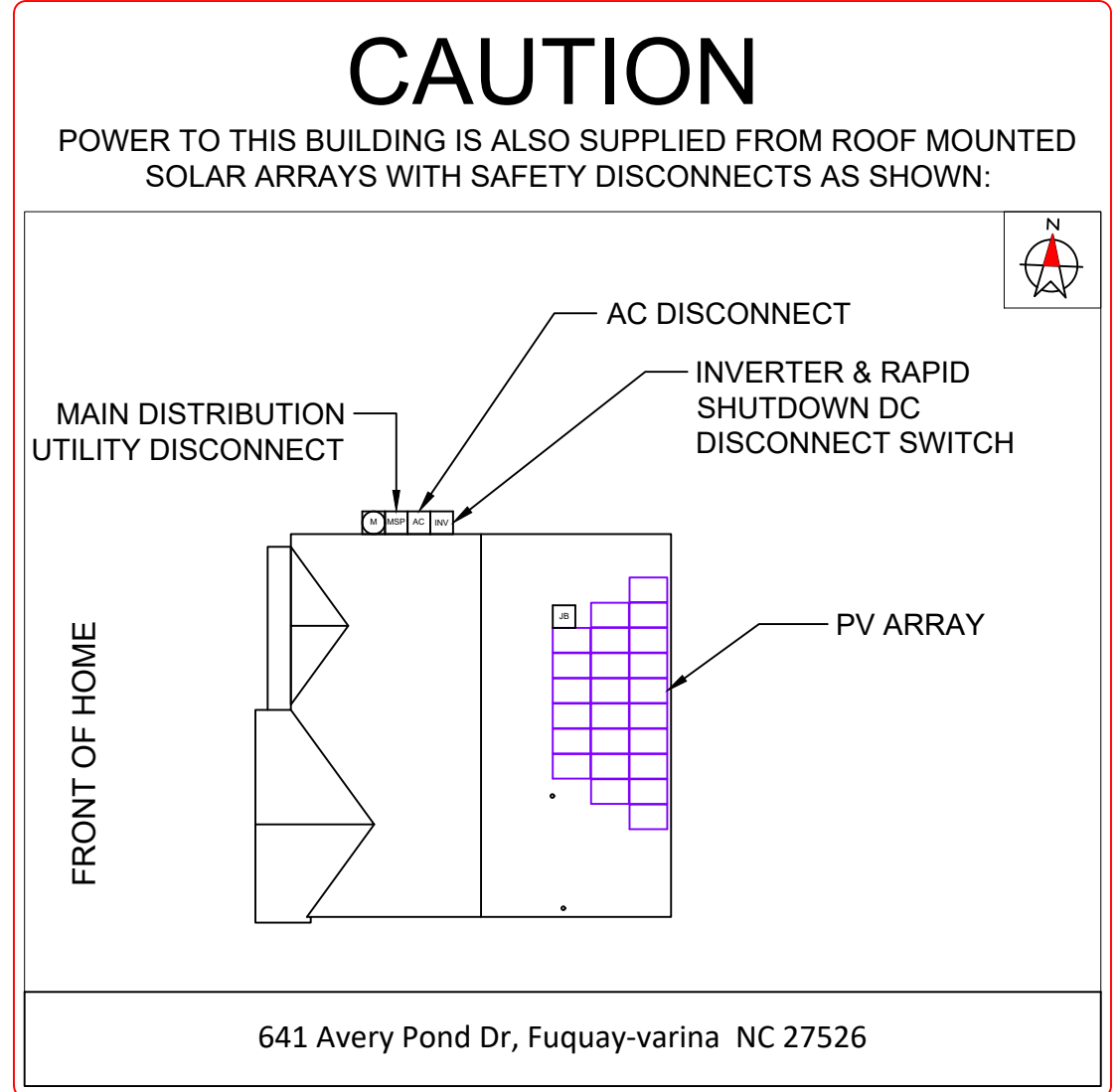

DIRECTORY
 PERMANENT PLAQUE OR DIRECTORY PROVIDING THE LOCATION OF THE SERVICE DISCONNECTING MEANS AND THE PHOTOVOLTAIC SYSTEM.

(ALL PLAQUES AND SIGNAGE WILL BE INSTALLED AS OUTLINED WITHIN:
 NEC 690.56(B)&(C), [NEC 705.10])



CONTRACTOR INFORMATION:

PALMETTO
Address: 1505 King St,
EXT ST 114
Charleston SC 29405

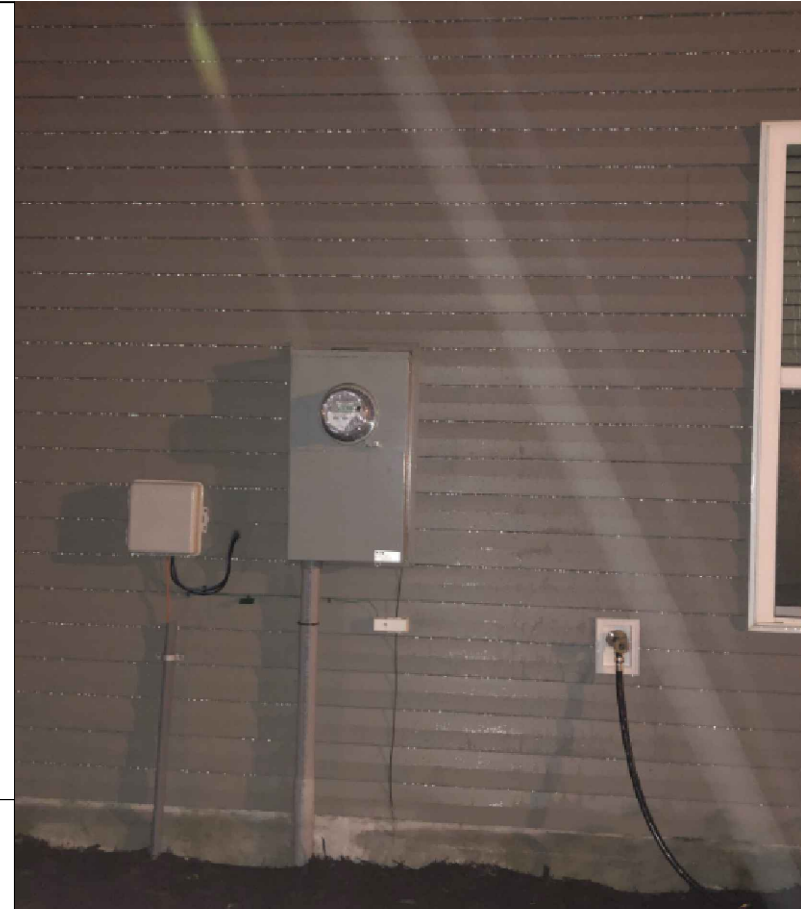

SITE INFORMATION:

Chris Sharpe
641 Avery Pond Dr, Fuquay-varina, NC 27526
MAX CONTINUOUS AC SYSTEM SIZE: 7.6 kW AC
DC SYSTEM SIZE: 8.04 kW DC
Lat, Long: 35.4965269351312, -78.8217472042297
(24) LG LG335N1K-V5 PV MODULES
(1) SolarEdge SE7600H-US (240V) INVERTER
Duke Energy NC

DATE: September 25, 2020

PAGE: PV09 SHEET NAME: SITE PHOTOS

DRAWN BY: SoloCAD

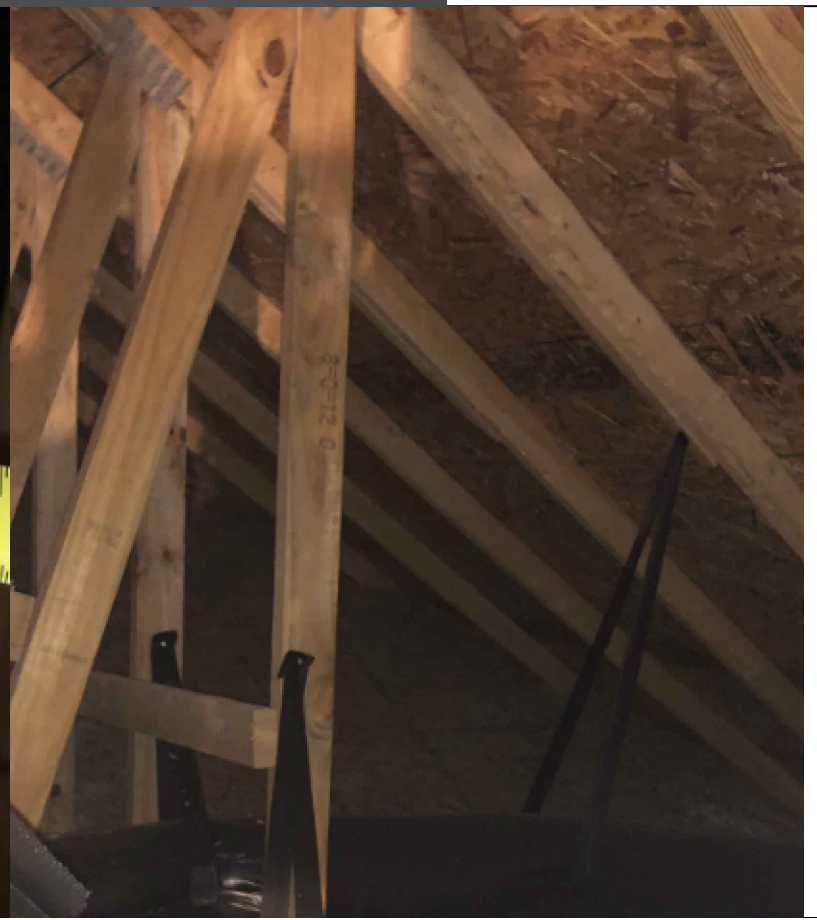

LG NeON[®] 2 Black

LG335N1K-V5

335W

The LG NeON[®] 2 is LG's best selling solar module, and is one of the most powerful and versatile modules on the market today. Featuring LG's Cello Technology, the LG NeON[®] 2 increases power output. New updates include an extended performance warranty from 86% to 90.08% to give customers higher performance and reliability.

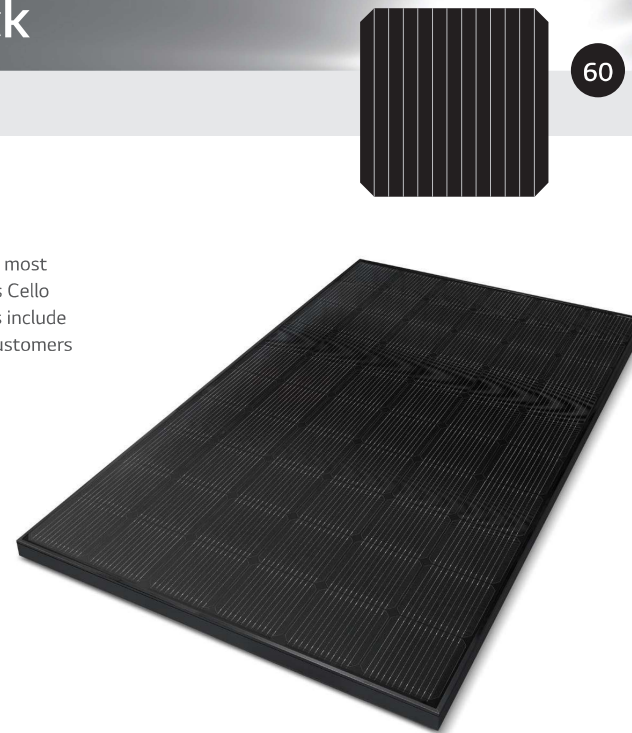

60

Features



Enhanced Performance Warranty

LG NeON[®] 2 Black has an enhanced performance warranty. After 25 years, LG NeON[®] 2 Black is guaranteed at least 90.08% of initial performance.



25-Year Limited Product Warranty

The NeON[®] 2 Black is covered by a 25-year limited product warranty. In addition, up to \$450 of labor costs will be covered in the rare case that a module needs to be repaired or replaced.



Solid Performance on Hot Days

LG NeON[®] 2 Black performs well on hot days due to its low temperature coefficient.



Roof Aesthetics

LG NeON[®] 2 Black has been designed with aesthetics in mind using thinner wires that appear all black at a distance.



Bifacial Energy Yield

LG NeON[®] 2 modules use a highly efficient bifacial solar cell, "NeON" applied Cello technology for better energy production than standard monofacial PV module.

When you go solar, ask for the brand you can trust: LG Solar

About LG Electronics USA, Inc.

LG Electronics is a global leader in electronic products in the clean energy markets by offering solar PV panels and energy storage systems. The company first embarked on a solar energy source research program in 1985, supported by LG Group's vast experience in the semi-conductor, LCD, chemistry and materials industries. In 2010, LG Solar successfully released its first Mono[®] series to the market, which is now available in 32 countries. The NeON[®] (previous Mono[®] NeON), NeON[®]2, NeON[®]2 BiFacial won the "Intersolar AWARD" in 2013, 2015 and 2016, which demonstrates LG's leadership and innovation in the solar industry.



LG NeON[®] 2 Black

LG335N1K-V5

General Data

Cell Properties (Material/Type)	Monocrystalline/N-type
Cell Maker	LG
Cell Configuration	60 Cells (6 x 10)
Number of Busbars	12EA
Module Dimensions (L x W x H)	1,686mm x 1,016mm x 40 mm
Weight	17.1 kg
Glass (Material)	Tempered Glass with AR Coating
Backsheet (Color)	Black
Frame (Material)	Anodized Aluminium
Junction Box (Protection Degree)	IP 68 with 3 Bypass Diodes
Cables (Length)	1,000mm x 2EA
Connector (Type/Maker)	MC 4/MC

Certifications and Warranty

Certifications	IEC 61215-1/-1-1/2:2016, IEC 61730-1/2:2016, UL 1703 ISO 9001, ISO 14001, ISO 50001 OHSAS 18001
Salt Mist Corrosion Test	IEC 62701:2012 Severity 6
Ammonia Corrosion Test	IEC 62716:2013
Module Fire Performance	Type 2 (UL 1703)
Fire Rating	Class C (UL 790, UL/C/ORD C 1703)
Solar Module Product Warranty	25 Year Limited
Solar Module Output Warranty	Linear Warranty*

*Improved: 1st year 98%, from 2-24th year: 0.33%/year down, 90.08% at year 25

Temperature Characteristics

NMOT*	[°C]	42 ± 3
Pmax	[%/°C]	-0.36
Voc	[%/°C]	-0.27
Isc	[%/°C]	0.03

*NMOT (Nominal Module Operating Temperature): Irradiance 800 W/m², Ambient temperature 20°C, Wind speed 1 m/s, Spectrum AM 1.5

Electrical Properties (NMOT)

Model	LG335N1K-V5	
Maximum Power (Pmax)	[W]	250
MPP Voltage (Vmpp)	[V]	32.3
MPP Current (Impp)	[A]	7.75
Open Circuit Voltage (Voc)	[V]	38.6
Short Circuit Current (Isc)	[A]	8.29

I-V Curves

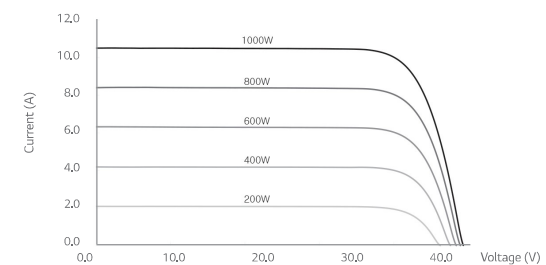

Electrical Properties (STC*)

Model	LG335N1K-V5	
Maximum Power (Pmax)	[W]	335
MPP Voltage (Vmpp)	[V]	34.5
MPP Current (Impp)	[A]	9.72
Open Circuit Voltage (Voc ± 5%)	[V]	41.1
Short Circuit Current (Isc ± 5%)	[A]	10.31
Module Efficiency	[%]	19.6
Bifaciality Coefficient of Power	[%]	10
Power Tolerance	[%]	0 ~ +3

*STC (Standard Test Condition): Irradiance 1000 W/m², Cell temperature 25°C, AM 1.5, Measure Tolerance: ±3%

Operating Conditions

Operating Temperature	[°C]	-40 ~ +90
Maximum System Voltage	[V]	1,000(U.L.), 1000(IEC)
Maximum Series Fuse Rating	[A]	20
Mechanical Test Load (Front)	[Pa/psf]	5,400/113
Mechanical Test Load (Rear)	[Pa/psf]	4,000/84

*Manufacturer Declaration according to IEC 61215:2005 Mechanical Test Loads 5,400 Pa/4,000 Pa based on IEC 61215-2:2016 (Test Load = Design Load x Safety Factor (1.5))

Packaging Configuration

Number of Modules per Pallet	[EA]	25
Number of Modules per 40' Container	[EA]	650
Number of Modules per 53' Container	[EA]	850
Packaging Box Dimensions (L x W x H)	[mm]	1750 x 1,120 x 1,221
Packaging Box Dimensions (L x W x H)	[in]	69 x 44.25 x 48.25
Packaging Box Gross Weight	[kg]	485
Packaging Box Gross Weight	[lb]	1,070

Dimensions (mm/inch)

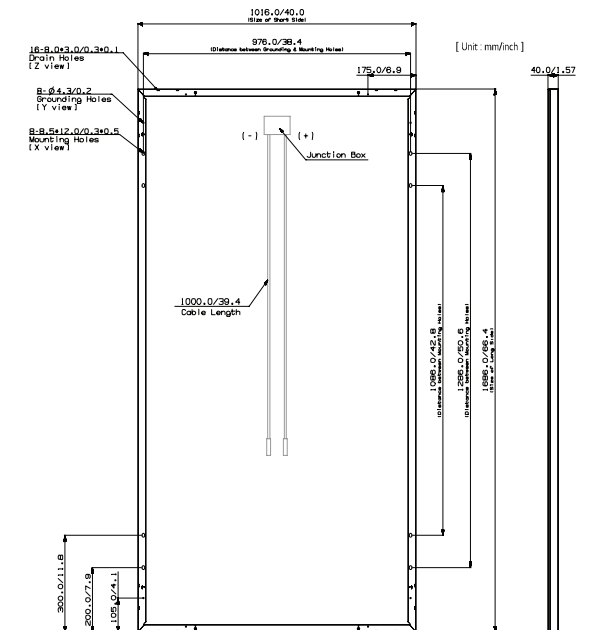

LG Electronics USA, Inc.
Solar Business Division
2000 Millbrook Drive
Lincolnshire, IL 60069
www.lg-solar.com

Product specifications are subject to change without notice.
LG335N1K-V5.pdf
051520

© 2020 LG Electronics USA, Inc. All rights reserved.

Single Phase Inverter with HD-Wave Technology

for North America

SE3000H-US / SE3800H-US / SE5000H-US / SE6000H-US / SE7600H-US / SE10000H-US / SE11400H-US

12-25
YEAR
WARRANTY



INVERTERS

Optimized installation with HD-Wave technology

- Specifically designed to work with power optimizers
- Record-breaking efficiency
- Fixed voltage inverter for longer strings
- Integrated arc fault protection and rapid shutdown for NEC 2014 and 2017, per article 690.11 and 690.12
- UL1741 SA certified, for CPUC Rule 21 grid compliance
- Extremely small
- Built-in module-level monitoring
- Outdoor and indoor installation
- Optional: Revenue grade data, ANSI C12.20 Class 0.5 (0.5% accuracy)

solaredge.com



Single Phase Inverter with HD-Wave Technology for North America

SE3000H-US / SE3800H-US / SE5000H-US / SE6000H-US / SE7600H-US / SE10000H-US / SE11400H-US

	SE3000H-US	SE3800H-US	SE5000H-US	SE6000H-US	SE7600H-US	SE10000H-US	SE11400H-US		
OUTPUT									
Rated AC Power Output	3000	3800 @ 240V 3300 @ 208V	5000	6000 @ 240V 5000 @ 208V	7600	10000	11400 @ 240V 10000 @ 208V	VA	
Maximum AC Power Output	3000	3800 @ 240V 3300 @ 208V	5000	6000 @ 240V 5000 @ 208V	7600	10000	11400 @ 240V 10000 @ 208V	VA	
AC Output Voltage Min.-Nom.-Max. (211 - 240 - 264)	✓	✓	✓	✓	✓	✓	✓	Vac	
AC Output Voltage Min.-Nom.-Max. (183 - 208 - 229)	-	✓	-	✓	-	-	✓	Vac	
AC Frequency (Nominal)	59.3 - 60 - 60.5 ¹⁾							Hz	
Maximum Continuous Output Current @240V	12.5	16	21	25	32	42	47.5	A	
Maximum Continuous Output Current @208V	-	16	-	24	-	-	48.5	A	
GFDI Threshold	1							A	
Utility Monitoring, Islanding Protection, Country Configurable Thresholds	Yes								
INPUT									
Maximum DC Power @240V	4650	5900	7750	9300	11800	15500	17650	W	
Maximum DC Power @208V	-	5100	-	7750	-	-	15500	W	
Transformer-less, Ungrounded	Yes								
Maximum Input Voltage	480							Vdc	
Nominal DC Input Voltage	380				400			Vdc	
Maximum Input Current @240V ²⁾	8.5	10.5	13.5	16.5	20	27	30.5	Adc	
Maximum Input Current @208V ²⁾	-	9	-	13.5	-	-	27	Adc	
Max. Input Short Circuit Current	45							Adc	
Reverse-Polarity Protection	Yes								
Ground-Fault Isolation Detection	600ka Sensitivity								
Maximum Inverter Efficiency	99	99.2						%	
CEC Weighted Efficiency	99						99 @ 240V 98.5 @ 208V	%	
Nighttime Power Consumption	< 2.5							W	
ADDITIONAL FEATURES									
Supported Communication Interfaces	RS485, Ethernet, ZigBee (optional), Cellular (optional)								
Revenue Grade Data, ANSI C12.20	Optional ³⁾								
Rapid Shutdown - NEC 2014 and 2017 690.12	Automatic Rapid Shutdown upon AC Grid Disconnect								
STANDARD COMPLIANCE									
Safety	UL1741, UL1741 SA, UL1699B, CSA C22.2, Canadian AFCI according to T.I.L. M-07								
Grid Connection Standards	IEEE1547, Rule 21, Rule 14 (H)								
Emissions	FCC Part 15 Class B								
INSTALLATION SPECIFICATIONS									
AC Output Conduit Size / AWG Range	1" Maximum / 14-6 AWG				1" Maximum / 14-4 AWG				
DC Input Conduit Size / # of Strings / AWG Range	1" Maximum / 1-2 strings / 14-6 AWG				1" Maximum / 1-3 strings / 14-6 AWG				
Dimensions with Safety Switch (HxWxD)	17.7 x 14.6 x 6.8 / 450 x 370 x 174				21.3 x 14.6 x 7.3 / 540 x 370 x 185				in / mm
Weight with Safety Switch	22 / 10	25.1 / 11.4	26.2 / 11.9	38.8 / 17.6				lb / kg	
Noise	< 25				< 50				dBA
Cooling	Natural Convection								
Operating Temperature Range	-13 to +140 / -25 to +60 ⁴⁾ (-40°F / -40°C option) ⁵⁾							°F / °C	
Protection Rating	NEMA 4X (Inverter with Safety Switch)								

¹⁾ For other regional settings please contact SolarEdge support

²⁾ A higher current source may be used; the inverter will limit its input current to the values stated

³⁾ Revenue grade inverter P/N: SExxxxH-US000NNC2

⁴⁾ For power de-rating information refer to: <https://www.solaredge.com/sites/default/files/se-temperature-derating-note-na.pdf>

⁵⁾ -40 version P/N: SExxxxH-US000NNU4

Power Optimizer

For North America

P320 / P340 / P370 / P400 / P405 / P505



POWER OPTIMIZER

PV power optimization at the module-level

- Specifically designed to work with SolarEdge inverters
- Up to 25% more energy
- Superior efficiency (99.5%)
- Mitigates all types of module mismatch losses, from manufacturing tolerance to partial shading
- Flexible system design for maximum space utilization
- Fast installation with a single bolt
- Next generation maintenance with module-level monitoring
- Meets NEC requirements for arc fault protection (AFCI) and Photovoltaic Rapid Shutdown System (PVRSS)
- Module-level voltage shutdown for installer and firefighter safety

solaredge.com



Power Optimizer For North America

P320 / P340 / P370 / P400 / P405 / P505

Optimizer model (typical module compatibility)	P320 (for 60-cell modules)	P340 (for high-power 60-cell modules)	P370 (for higher-power 60 and 72-cell modules)	P400 (for 72 & 96-cell modules)	P405 (for thin film modules)	P505 (for higher current modules)	
INPUT							
Rated Input DC Power ⁽¹⁾	320	340	370	400	405	505	W
Absolute Maximum Input Voltage (Voc at lowest temperature)	48		60	80	125 ⁽²⁾	87 ⁽²⁾	Vdc
MPPT Operating Range	8 - 48		8 - 60	8 - 80	12.5 - 105	12.5 - 87	Vdc
Maximum Short Circuit Current (Isc)	11			10.1		14	Adc
Maximum DC Input Current	13.75			12.5		17.5	Adc
Maximum Efficiency	99.5						%
Weighted Efficiency	98.8					98.6	%
Overvoltage Category	II						
OUTPUT DURING OPERATION (POWER OPTIMIZER CONNECTED TO OPERATING SOLAREEDGE INVERTER)							
Maximum Output Current	15						Adc
Maximum Output Voltage	60			85			Vdc
OUTPUT DURING STANDBY (POWER OPTIMIZER DISCONNECTED FROM SOLAREEDGE INVERTER OR SOLAREEDGE INVERTER OFF)							
Safety Output Voltage per Power Optimizer	1 ± 0.1						Vdc
STANDARD COMPLIANCE							
EMC	FCC Part15 Class B, IEC61000-6-2, IEC61000-6-3						
Safety	IEC62109-1 (class II safety), UL1741						
Material	UL94 V-0, UV Resistant						
RoHS	Yes						
INSTALLATION SPECIFICATIONS							
Maximum Allowed System Voltage	1000						Vdc
Compatible inverters	All SolarEdge Single Phase and Three Phase inverters						
Dimensions (W x L x H)	129 x 153 x 27.5 / 5.1 x 6 x 1.1		129 x 153 x 33.5 / 5.1 x 6 x 1.3	129 x 159 x 49.5 / 5.1 x 6.3 x 1.9	129 x 162 x 59 / 5.1 x 6.4 x 2.3		mm / in
Weight (including cables)	630 / 1.4		750 / 1.7	845 / 1.9	1064 / 2.3		gr / lb
Input Connector	Single or dual MC4 ⁽³⁾						
Input Wire Length	0.16 / 0.52						m / ft
Output Wire Type / Connector	Double Insulated / MC4						
Output Wire Length	0.9 / 2.95		1.2 / 3.9				m / ft
Operating Temperature Range	-40 - +85 / -40 - +185						°C / °F
Protection Rating	IP68 / NEMA6P						
Relative Humidity	0 - 100						%

⁽¹⁾ Rated power of the module at STC will not exceed the optimizer "Rated Input DC Power". Modules with up to +5% power tolerance are allowed

⁽²⁾ NEC 2017 requires max input voltage be not more than 80V

⁽³⁾ For other connector types please contact SolarEdge

PV System Design Using a SolarEdge Inverter ⁽⁴⁾⁽⁵⁾	Single Phase HD-Wave	Single phase	Three Phase 208V	Three Phase 480V	
Minimum String Length (Power Optimizers)	P320, P340, P370, P400 P405 / P505	8	10	18	
Maximum String Length (Power Optimizers)		6	13 (12 with SE3K)	14	
Maximum String Length (Power Optimizers)		25	25	50 ⁽⁶⁾	
Maximum Power per String	5700 (6000 with SE7600-US - SE11400-US)	5250	6000 ⁽⁷⁾	12750 ⁽⁸⁾	W
Parallel Strings of Different Lengths or Orientations	Yes				

⁽⁴⁾ For detailed string sizing information refer to: http://www.solaredge.com/sites/default/files/string_sizing_na.pdf

⁽⁵⁾ It is not allowed to mix P405/P505 with P320/P340/P370/P400 in one string

⁽⁶⁾ A string with more than 30 optimizers does not meet NEC rapid shutdown requirements; safety voltage will be above the 30V requirement

⁽⁷⁾ For SE14.4KUS/SE43.2KUS: It is allowed to install up to 6,500W per string when 3 strings are connected to the inverter (3 strings per unit for SE43.2KUS) and when the maximum power difference between the strings is up to 1,000W

⁽⁸⁾ For SE30KUS/SE33.3KUS/SE66.6KUS/SE100KUS: It is allowed to install up to 15,000W per string when 3 strings are connected to the inverter (3 strings per unit for SE66.6KUS/SE100KUS) and when the maximum power difference between the strings is up to 2,000W

© SolarEdge Technologies Ltd. All rights reserved. SOLAREEDGE, the SolarEdge logo, OPTIMIZED BY SOLAREEDGE are trademarks or registered trademarks of SolarEdge Technologies, Inc. All other trademarks mentioned herein are trademarks of their respective owners. Date: 07/2019/V01/ENG NAM. Subject to change without notice.

CE RoHS

SOLARMOUNT



SOLARMOUNT is the professionals' choice for residential PV mounting applications. Every aspect of the system is designed for an easier, faster installation experience. SOLARMOUNT is a complete solution with revolutionary universal clamps, FLASHKIT PRO, full system UL 2703 certification and 25-year warranty. Not only is SOLARMOUNT easy to install, but best-in-class aesthetics make it the most attractive on any block!

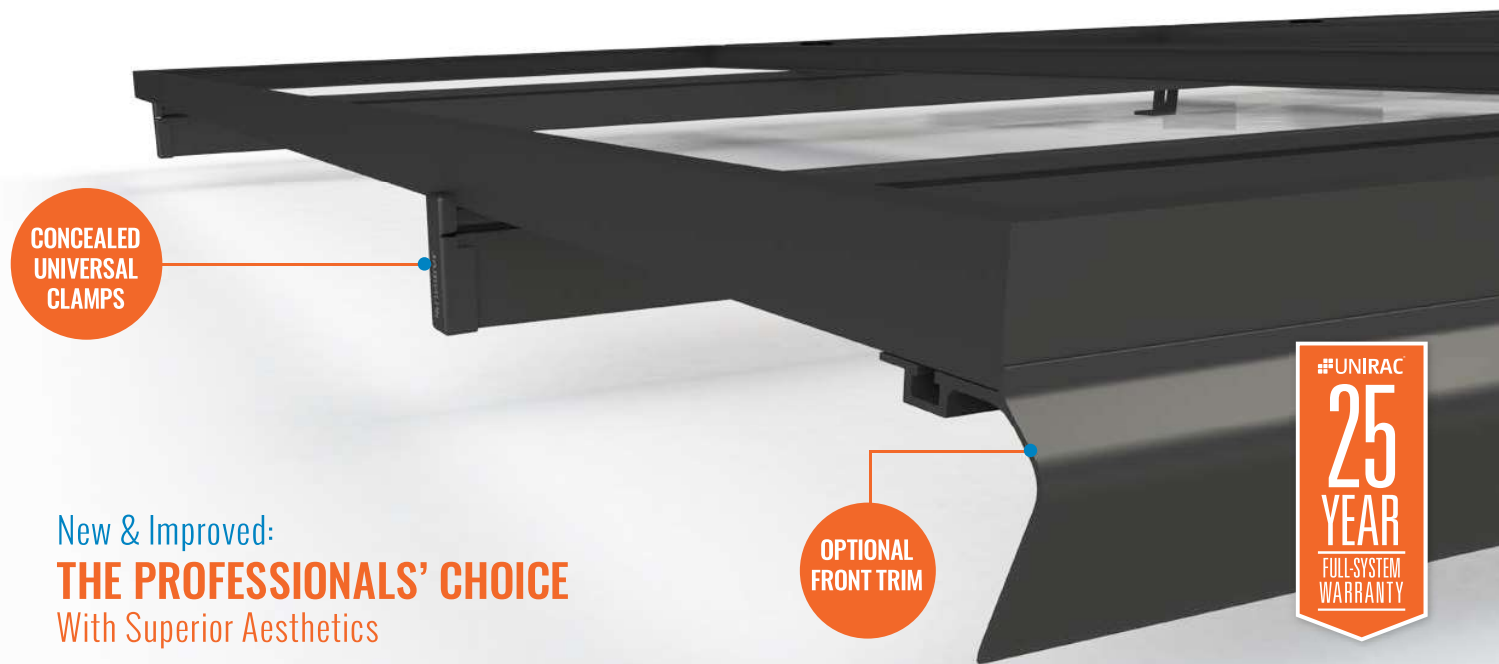

New & Improved:
THE PROFESSIONALS' CHOICE
With Superior Aesthetics



NOW FEATURING FLASHKIT PRO
The Complete Roof Attachment Solution
FEATURING EcoFasten Solar[®] TECHNOLOGY



NOW WITH UNIVERSAL MIDCLAMPS
Accommodates 30mm-51mm module frames
One tool, one-person installs are here!



REVOLUTIONARY NEW ENDCLAMPS
Concealed design and included End Caps

THE PROFESSIONALS' CHOICE FOR RESIDENTIAL RACKING

BEST INSTALLATION EXPERIENCE • CURB APPEAL • COMPLETE SOLUTION • UNIRAC SUPPORT

SOLARMOUNT



BETTER DESIGNS

TRUST THE INDUSTRY'S BEST DESIGN TOOL

Start the design process for every project in our U-Builder on-line design tool. It's a great way to save time and money.

BETTER SYSTEMS

ONE SYSTEM - MANY APPLICATIONS

Quickly set modules flush to the roof on steep pitched roofs. Orient a large variety of modules in Portrait or Landscape. Tilt the system up on flat or low slow roofs. Components available in mill, clear, and dark finishes to optimize your design financials and aesthetics.

BETTER RESULTS

MAXIMIZE PROFITABILITY ON EVERY JOB

Trust Unirac to help you minimize both system and labor costs from the time the job is quoted to the time your teams get off the roof. Faster installs. Less Waste. More Profits.

BETTER SUPPORT

WORK WITH THE INDUSTRIES MOST EXPERIENCED TEAM

Professional support for professional installers and designers. You have access to our technical support and training groups. Whatever your support needs, we've got you covered. Visit Unirac.com/solarmount for more information.



CONCEALED UNIVERSAL ENDCLAMPS

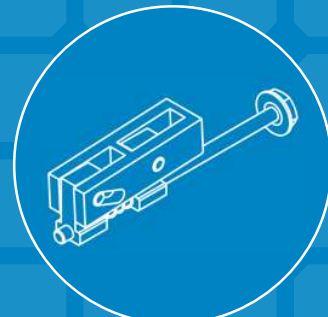

END CAPS INCLUDED WITH EVERY ENDCLAMP

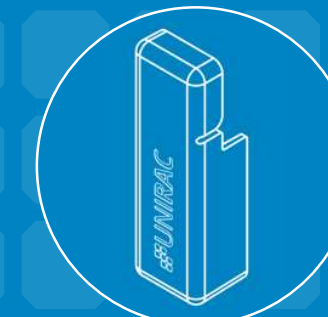

UNIVERSAL SELF-STANDING MIDCLAMPS

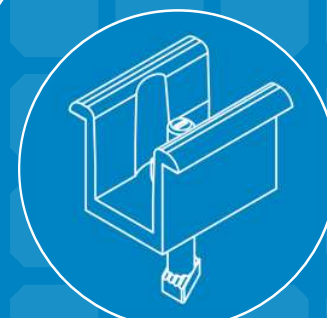

U-BUILDER ONLINE DESIGN TOOL SAVES TIME & MONEY

Visit design.unirac.com

UNIRAC CUSTOMER SERVICE MEANS THE HIGHEST LEVEL OF PRODUCT SUPPORT

UNMATCHED EXPERIENCE	CERTIFIED QUALITY	ENGINEERING EXCELLENCE	BANKABLE WARRANTY	DESIGN TOOLS	PERMIT DOCUMENTATION
----------------------	-------------------	------------------------	-------------------	--------------	----------------------

TECHNICAL SUPPORT

Unirac's technical support team is dedicated to answering questions & addressing issues in real time. An online library of documents including engineering reports, stamped letters and technical data sheets greatly simplifies your permitting and project planning process.

CERTIFIED QUALITY PROVIDER

Unirac is the only PV mounting vendor with ISO certifications for 9001:2008, 14001:2004 and OHSAS 18001:2007, which means we deliver the highest standards for fit, form, and function. These certifications demonstrate our excellence and commitment to first class business practices.

BANKABLE WARRANTY

Don't leave your project to chance, Unirac has the financial strength to back our products and reduce your risk. Have peace of mind knowing you are providing products of exceptional quality. SOLARMOUNT is covered by a 25 year limited product warranty and a 5 year limited finish warranty.

ENHANCE YOUR REPUTATION WITH QUALITY RACKING SOLUTIONS BACKED BY ENGINEERING EXCELLENCE AND A SUPERIOR SUPPLY CHAIN

PUB2016MAY16 - PRINTED UPDATE

FLASHKIT PRO



FLASHKIT PRO is the complete attachment solution for composition shingle roofs. Featuring Unirac's patented **SHED & SEAL** technology, a weather proof system which provides the ultimate protection against roof leaks. Kitted in 10 packs for maximum convenience, flashings and hardware are available in Mill or Dark finishes. With **FLASHKIT pro**, you have everything you need for a quick, professional installation.



TRUSTED WATER SEAL FLASHINGS
FEATURING SHED & SEAL TECHNOLOGY



YOUR COMPLETE SOLUTION
Flashings, lags, continuous slot L-Feet and hardware



CONVENIENT 10 PACKS
Packaged for speed and ease of handling

FLASHKIT PRO

INSTALLATION GUIDE



FLASHKIT PRO IS THE COMPLETE FLASHING AND ATTACHMENT SOLUTION FOR COMPOSITION ROOFS.



STEP 1
INSTALL FLASHKIT PRO FLASHING



STEP 2
INSTALL L-FOOT



STEP 3
ATTACH L-FOOT TO RAIL

PRE-INSTALL

- Locate roof rafters and snap chalk lines to mark the installation point for each roof attachment.
- Drill a 7/32" pilot hole at each roof attachment. Fill each pilot hole with sealant.

STEP 1 INSTALL FLASHKIT PRO FLASHING

- Add a U-shaped bead of roof sealant to the underside of the flashing with the open side of the U pointing down the roof slope. Slide the aluminum flashing underneath the row of shingles directly up slope from the pilot hole as shown. Align the indicator marks on the lower end of the flashing with the chalk lines on the roof to center the raised hole in the flashing over the pilot hole in the roof. When installed correctly, the flashing will extend under the two courses of shingles above the pilot hole.

STEP 2 INSTALL L-FOOT

- Fasten L-foot and Flashing into place by passing the included lag bolt and pre-installed stainless steel-backed EPDM washer through the L-foot EPDM grommet, and the raised hole in the flashing, into the pilot hole in the roof rafter.

- Drive the lag bolt down until the L-foot is held firmly in place. It is normal for the EPDM on the underside of the stainless steel backed EPDM washer to compress and expand beyond the outside edge of the steel washer when the proper torque is applied.

TIP:

- Use caution to avoid over-torquing the lag bolt if using an impact driver.
- Repeat Steps 1 and 2 at each roof attachment point.

STEP 3 ATTACH L-FOOT TO RAIL

- Insert the included 3/8" -16 T-bolts into the lower slot on the Rail (sold separately), spacing the bolts to match the spacing between the roof attachments.
- Position the Rail against the L-Foot and insert the threaded end of the T-Bolt through the continuous slot in the L-Foot. Apply anti-seize to bolt threads to prevent galling of the T-bolt and included 3/8" serrated flange nut. Place the 3/8" flange nut on the T-bolt and finger tighten. Repeat STEP 3 until all L-Feet are secured to the Rail with a T-bolt. Adjust the level and height of the Rail and torque each bolt to 30ft-lbs.

THE COMPLETE ROOF ATTACHMENT SOLUTION

FOR QUESTIONS OR CUSTOMER SERVICE VISIT UNIRAC.COM OR CALL (505) 248-2702

FASTER INSTALLATION. 25-YEAR WARRANTY.

FOR QUESTIONS OR CUSTOMER SERVICE VISIT UNIRAC.COM OR CALL (505) 248-2702