

© 2019 NC SOLAR NOW EXPRESSLY RESERVES ITS COMMON LAW COPYRIGHT AND OTHER PROPERTY RIGHTS IN THESE PLANS. THESE PLANS ARE NOT TO BE REPRODUCED, CHANGED OR COPIED IN ANY FORM OR MANNER WHATSOEVER, NOR ARE THEY TO BE ASSIGNED TO ANY THIRD PARTY WITHOUT FIRST OBTAINING THE EXPRESSED WRITTEN PERMISSION AND CONSENT OF NC SOLAR NOW.

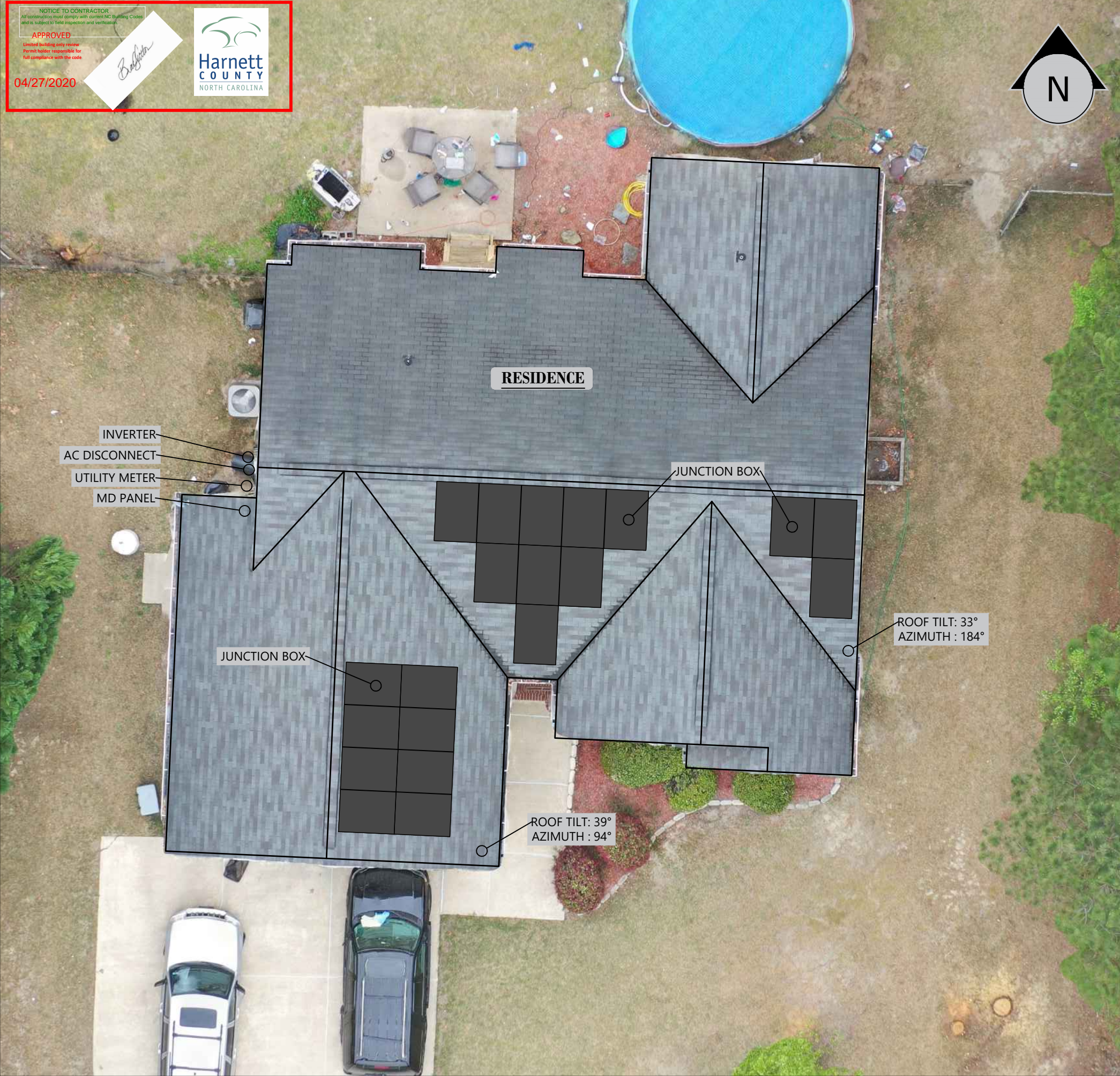

NOTICE TO CONTRACTOR
All construction must comply with current NC Building Codes and is subject to field inspection and verification.

APPROVED
United Building only permit
Permit holder responsible for full compliance with the code

04/27/2020

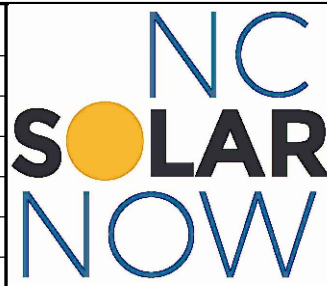
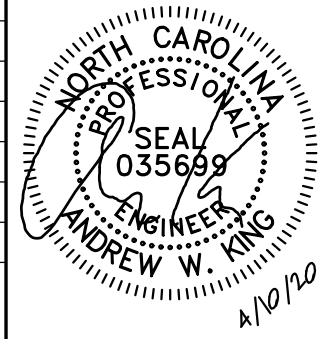

MATERIALS SUMMARY	
PART:	QTY:
REC 320NP BLACK	20
SOLAREGE P320 OPTIMIZER	20
SOLAREGE SE6000H-US INVERTER	1
SOLADECK ENCLOSURE	3
168" XR10 IRONRIDGE RAIL	7
204" XR10 IRONRIDGE RAIL	2
XR10 BONDED SPLICE	0
UFO CLAMP	54
STOPPER SLEEVE (30 MM)	28
GD-LUG-003	7
QUICKBOLT ATTACHMENT	58
CELL CARD	0

CLIENT INFO
EDWIN ALVARADO
195 MONTANA LANE
SPRING LAKE, NC 28390

PROJECT INFO
DC INPUT: 6.4 kW
AC EXPORT: 6.0 kW
DOI INSPT. METHOD: OPTION 2

CODE REFERENCES
NATION ELECTRICAL CODE v. 2017
NC FIRE PROTECTION CODE v. 2018
NC BUILDING CODE v. 2018
NC RESIDENTIAL CODE v. 2018
ACSE v. 7-10

SITE CONDITIONS
WIND SPEED: 118 MPH
RISK CATEGORY: II
EXPOSURE: B
SNOW: 10 PSF

SHEET INDEX
PV-1: COVER SHEET
PV-2: PV STRUCTURAL
PV-3: PV ELECTRICAL
PV-4: PV EQUIPMENT LABELS
PV-5: PV INSTALL GUIDE

DESIGN INFO
DESIGNER: CVV
ENGINEER: AWK
DATE: 04-06-2020
VERSION: P1

PV SYSTEM COVER PAGE

PV-1.1



SALES FORCE



SITE VISIT



INSTALL

© 2019 NC SOLAR NOW EXPRESSLY RESERVES ITS COMMON LAW COPYRIGHT AND OTHER PROPERTY RIGHTS IN THESE PLANS. THESE PLANS ARE NOT TO BE REPRODUCED, CHANGED OR COPIED IN ANY FORM OR MANNER WHATSOEVER, NOR ARE THEY TO BE ASSIGNED TO ANY THIRD PARTY WITHOUT FIRST OBTAINING THE EXPRESSED WRITTEN PERMISSION AND CONSENT OF NC SOLAR NOW.

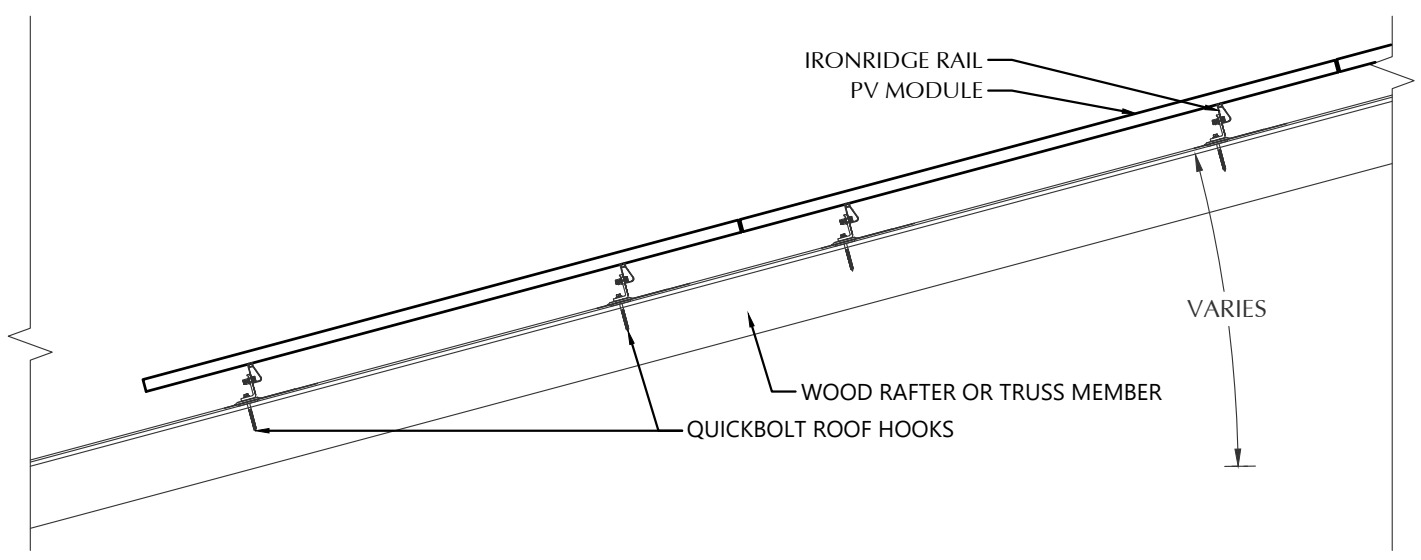

STATEMENT OF STRUCTURAL COMPLIANCE

THE EXISTING ROOF STRUCTURE HAS BEEN DESIGNED TO SUPPORT THE ADDITIONAL LOADS OF THE PROPOSED PV SYSTEM. IN ADDITION, THE RACKING AND FASTENING SYSTEM SHALL BE CAPABLE OF SECURING THE SYSTEM TO THE STRUCTURE UNDER DESIGN CONDITIONS WHEN INSTALLED PROPERLY AND IN ACCORDANCE WITH THE RACKING AND FASTENING ARRANGEMENT DETAILED WITHIN THESE DRAWINGS.

NAME: ANDREW W. KING, PE
 SIGNED: *Andrew W. King*

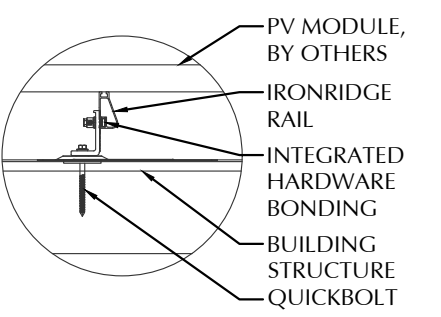
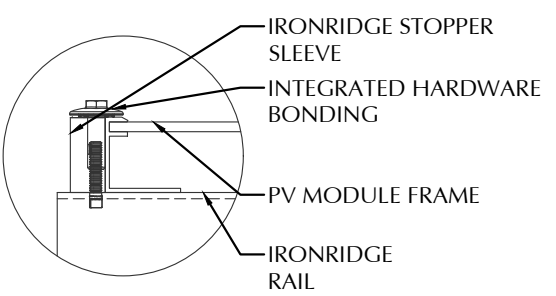
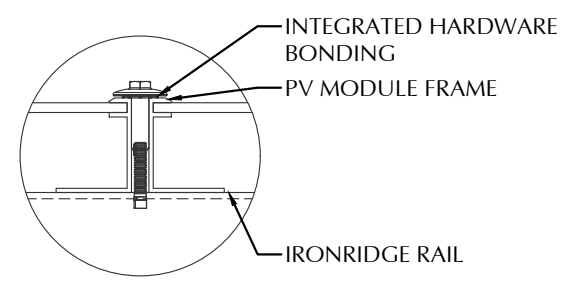
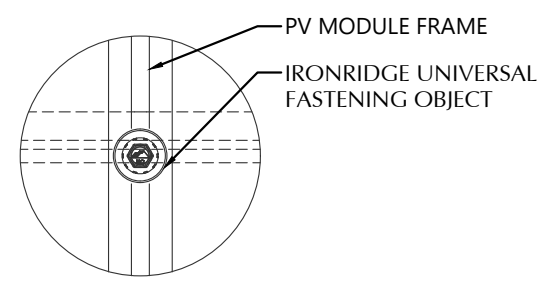
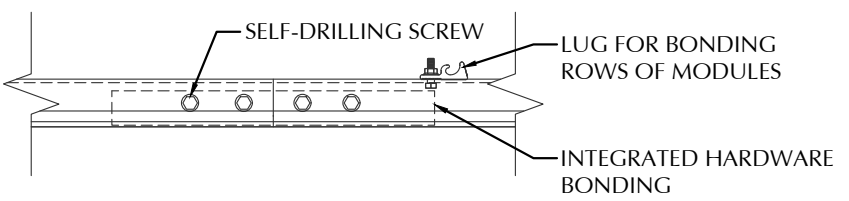

1 ROOF FASTENER DETAIL NOT TO SCALE

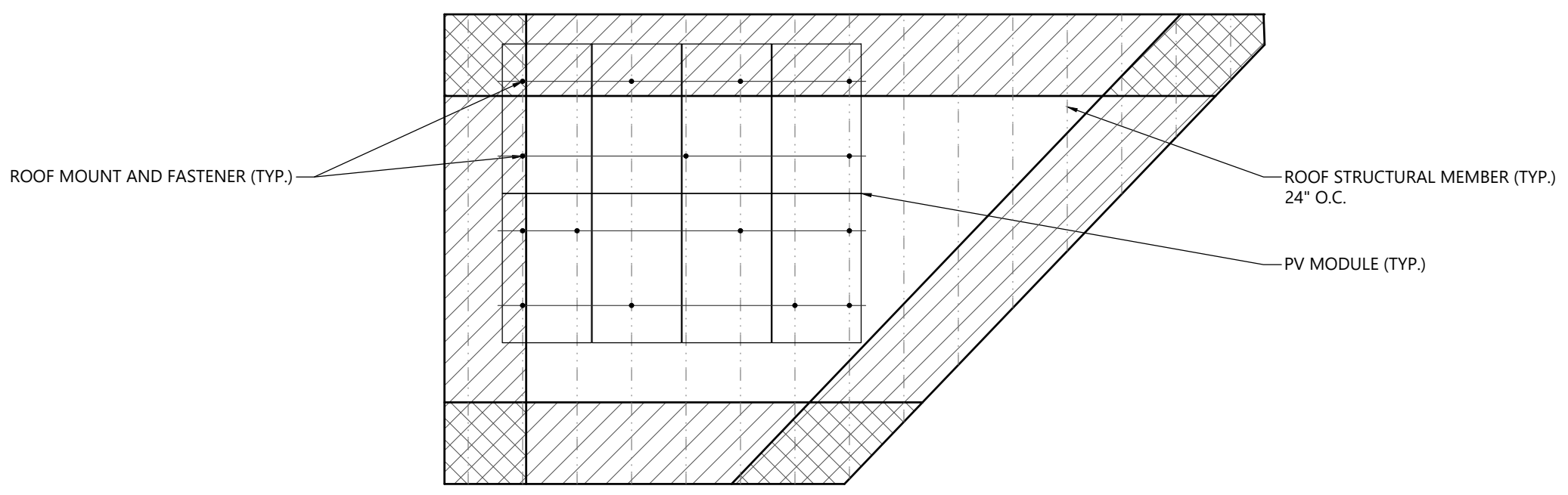

2 ARRAY LAYOUT 3/16" = 1'-0"

PV MODULES	
MAKE	REC
MODEL	REC 320NP BLACK
WIDTH	39.25"
LENGTH	65.9"
THICKNESS	30 mm
WEIGHT	39.7 LBS.
ARRAY AREA	144 SQFT.
ARRAY WEIGHT	359 LBS.

ROOF SUMMARY	
STRUCTURE:	
TYPE	TRUSSES
MATERIAL	SOUTHERN PINE #2
SIZE	2" X 4"
SPACING	24 IN O.C.
TOTAL SPAN	160 IN
PITCH	10/12
DENSITY	30 LBS./CU.FT.
DECKING:	
TYPE	OSB
MATERIAL	COMPOSITE
THICKNESS	7/16 IN
WEIGHT	1.60 LBS./SQFT
ROOFING:	
TYPE	ARCH SHINGLE
MATERIAL	ASPHALT
WEIGHT	2.3 LBS./SQFT.

ROOF MOUNT SUMMARY		
MAXIMUM	MOUNT SPACING	RAIL OVERHANG
WIND ZONE 1	72 IN	19 IN
WIND ZONE 2	48 IN	19 IN
WIND ZONE 3	48 IN	19 IN

ROOF LOADING	
GROUND SNOW LOAD:	15 LBS./SQFT.
LIVE LOAD	20 LBS./SQFT.
DEAD LOAD	
ROOFING	3.9 LBS./SQFT.
PV ARRAY	2.5 LBS./SQFT.
TOTAL	6.4 LBS./SQFT.
WIND LOAD:	
UPLIFT ZONE 1	-24.6 LBS./SQFT.
UPLIFT ZONE 2	-29.0 LBS./SQFT.
UPLIFT ZONE 3	-29.0 LBS./SQFT.
DOWNWARD	23.0 LBS./SQFT.
FASTENER LOAD:	
UPLIFT ZONE 1	-405 LBS.
UPLIFT ZONE 2	-319 LBS.
UPLIFT ZONE 3	-319 LBS.
DOWNWARD	379 LBS.

ROOF MOUNT & FASTENER	
ROOF MOUNT:	
MAKE	SOLAR ROOF HOOK
MODEL	L-FOOT
MATERIAL	ALUMINUM
FASTENER:	
MAKE	SOLAR ROOF HOOK
MODEL	QUICKBOLT
MATERIAL	304 SS
SIZE	5/16-18 X 5.25"
GENERAL:	
WEIGHT	1 LBS.
FASTENERS PER MOUNT	1
MAX. PULL-OUT FORCE	960 LBS. / MOUNT
SAFETY FACTOR	2.0
DESIGN PULL-OUT FORCE	480 LBS. / MOUNT

MOUNTING RAILS	
MAKE	IRONRIDGE
MODEL	XR10
MATERIAL	ALUMINUM
WEIGHT	.436 LBS./FT.
SPACING	34 IN.

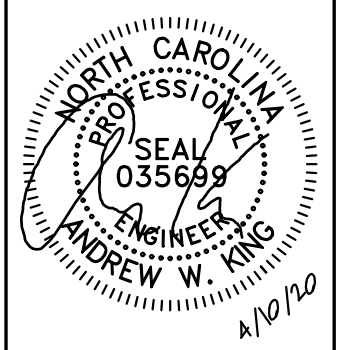

CLIENT INFO
 EDWIN ALVARADO
 195 MONTANA LANE
 SPRING LAKE, NC 28390

PROJECT INFO
 DC INPUT: 6.4 kW
 AC EXPORT: 6.0 kW
 DOI INSPT. METHOD: OPTION 2

CODE REFERENCES
 NATION ELECTRICAL CODE v. 2017
 NC FIRE PROTECTION CODE v. 2018
 NC BUILDING CODE v. 2018
 NC RESIDENTIAL CODE v. 2018
 ACSE v. 7-10

SITE CONDITIONS
 WIND SPEED: 118 MPH
 RISK CATEGORY: II
 EXPOSURE: B
 SNOW: 10 PSF

SHEET INDEX
 PV-1: COVER SHEET
 PV-2: PV STRUCTURAL
 PV-3: PV ELECTRICAL
 PV-4: PV EQUIPMENT LABELS
 PV-5: PV INSTALL GUIDE

DESIGN INFO
 DESIGNER: CVV
 ENGINEER: AWK
 DATE: 04-06-2020
 VERSION: P1

PV SYSTEM STRUCTURAL

PV-2.1

© 2019 NC SOLAR NOW EXPRESSLY RESERVES ITS COMMON LAW COPYRIGHT AND OTHER PROPERTY RIGHTS IN THESE PLANS. THESE PLANS ARE NOT TO BE REPRODUCED, CHANGED OR COPIED IN ANY FORM OR MANNER WHATSOEVER, NOR ARE THEY TO BE ASSIGNED TO ANY THIRD PARTY WITHOUT FIRST OBTAINING THE EXPRESSED WRITTEN PERMISSION AND CONSENT OF NC SOLAR NOW.

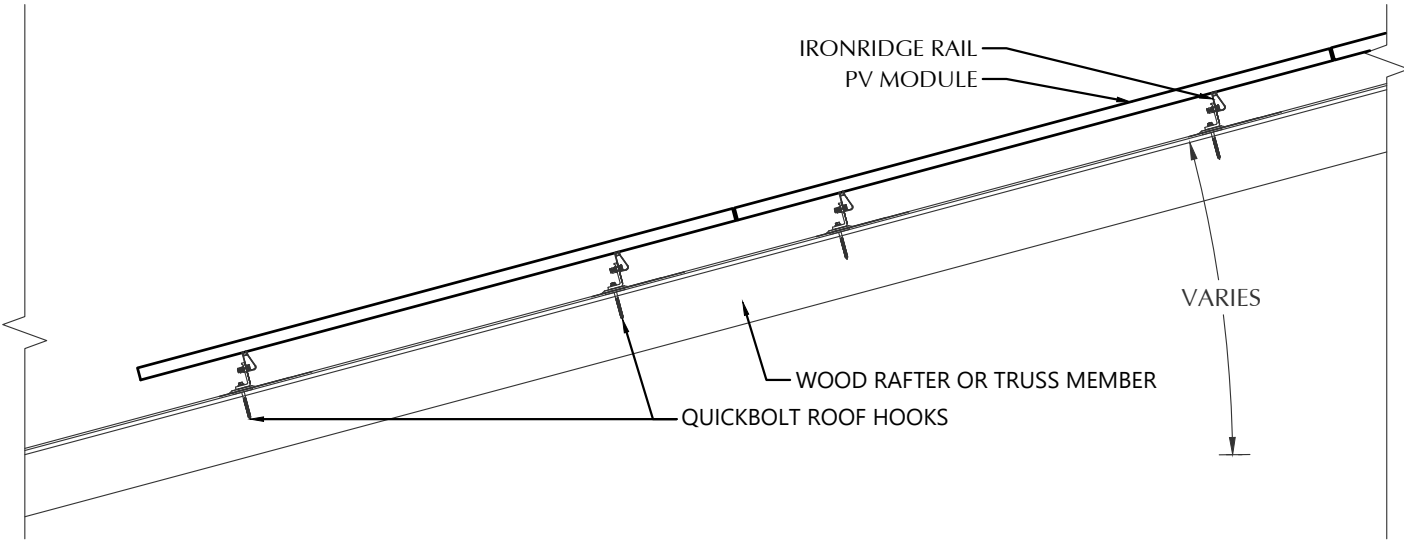

STATEMENT OF STRUCTURAL COMPLIANCE

THE EXISTING ROOF STRUCTURE HAS BEEN DESIGNED TO SUPPORT THE ADDITIONAL LOADS OF THE PROPOSED PV SYSTEM. IN ADDITION, THE RACKING AND FASTENING SYSTEM SHALL BE CAPABLE OF SECURING THE SYSTEM TO THE STRUCTURE UNDER DESIGN CONDITIONS WHEN INSTALLED PROPERLY AND IN ACCORDANCE WITH THE RACKING AND FASTENING ARRANGEMENT DETAILED WITHIN THESE DRAWINGS.

NAME: ANDREW W. KING, PE

SIGNED: *Andrew W. King*

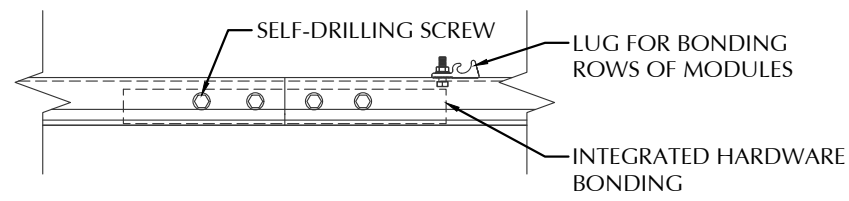

PV MODULES	
MAKE	REC
MODEL	REC 320NP BLACK
WIDTH	39.25"
LENGTH	65.9"
THICKNESS	30 mm
WEIGHT	39.7 LBS.
ARRAY AREA	216 SQFT.
ARRAY WEIGHT	539 LBS.

ROOF SUMMARY	
STRUCTURE:	
TYPE	TRUSSES
MATERIAL	SOUTHERN PINE #2
SIZE	2" X 4"
SPACING	24 IN O.C.
TOTAL SPAN	185 IN
PITCH	8/12
DENSITY	30 LBS./CU.FT.
DECKING:	
TYPE	OSB
MATERIAL	COMPOSITE
THICKNESS	7/16 IN
WEIGHT	1.60 LBS/SQFT
ROOFING:	
TYPE	ARCH SHINGLE
MATERIAL	ASPHALT
WEIGHT	2.3 LBS./SQFT.

ROOF MOUNT SUMMARY			
	MAXIMUM	MOUNT SPACING	RAIL OVERHANG
WIND ZONE 1	72 IN		19 IN
WIND ZONE 2	48 IN		19 IN
WIND ZONE 3	48 IN		19 IN

ROOF LOADING	
GROUND SNOW LOAD:	15 LBS./SQFT.
LIVE LOAD	20 LBS./SQFT.
DEAD LOAD	
ROOFING	3.9 LBS./SQFT.
PV ARRAY	2.5 LBS./SQFT.
TOTAL	6.4 LBS./SQFT.
WIND LOAD:	
UPLIFT ZONE 1	-24.6 LBS./SQFT.
UPLIFT ZONE 2	-29.0 LBS./SQFT.
UPLIFT ZONE 3	-29.0 LBS./SQFT.
DOWNWARD	23.0 LBS./SQFT.
FASTENER LOAD:	
UPLIFT ZONE 1	-405 LBS.
UPLIFT ZONE 2	-319 LBS.
UPLIFT ZONE 3	-319 LBS.
DOWNWARD	379 LBS.

ROOF MOUNT & FASTENER	
ROOF MOUNT:	
MAKE	SOLAR ROOF HOOK
MODEL	L-FOOT
MATERIAL	ALUMINUM
FASTENER:	
MAKE	SOLAR ROOF HOOK
MODEL	QUICKBOLT
MATERIAL	304 SS
SIZE	5/16-18 X 5.25"
GENERAL:	
WEIGHT	1 LBS.
FASTENERS PER MOUNT	1
MAX. PULL-OUT FORCE	960 LBS. / MOUNT
SAFETY FACTOR	2.0
DESIGN PULL-OUT FORCE	480 LBS. / MOUNT

MOUNTING RAILS	
MAKE	IRONRIDGE
MODEL	XR10
MATERIAL	ALUMINUM
WEIGHT	.436 LBS./FT.
SPACING	34 IN.

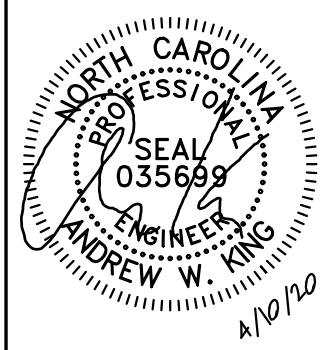
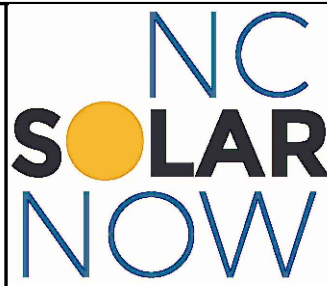

CLIENT INFO
 EDWIN ALVARADO
 195 MONTANA LANE
 SPRING LAKE, NC 28390

PROJECT INFO
 DC INPUT: 6.4 kW
 AC EXPORT: 6.0 kW
 DOI INSPT. METHOD: OPTION 2

CODE REFERENCES
 NATION ELECTRICAL CODE v. 2017
 NC FIRE PROTECTION CODE v. 2018
 NC BUILDING CODE v. 2018
 NC RESIDENTIAL CODE v. 2018
 ACSE v. 7-10

SITE CONDITIONS
 WIND SPEED: 118 MPH
 RISK CATEGORY: II
 EXPOSURE: B
 SNOW: 10 PSF

SHEET INDEX
 PV-1: COVER SHEET
 PV-2: PV STRUCTURAL
 PV-3: PV ELECTRICAL
 PV-4: PV EQUIPMENT LABELS
 PV-5: PV INSTALL GUIDE

DESIGN INFO
 DESIGNER: CVV
 ENGINEER: AWK
 DATE: 04-06-2020
 VERSION: P1

PV SYSTEM STRUCTURAL

PV-2.2

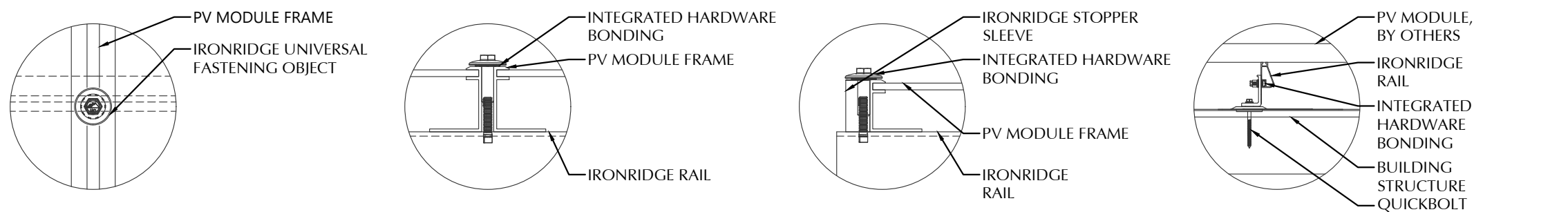

1 ROOF FASTENER DETAIL
 NOT TO SCALE

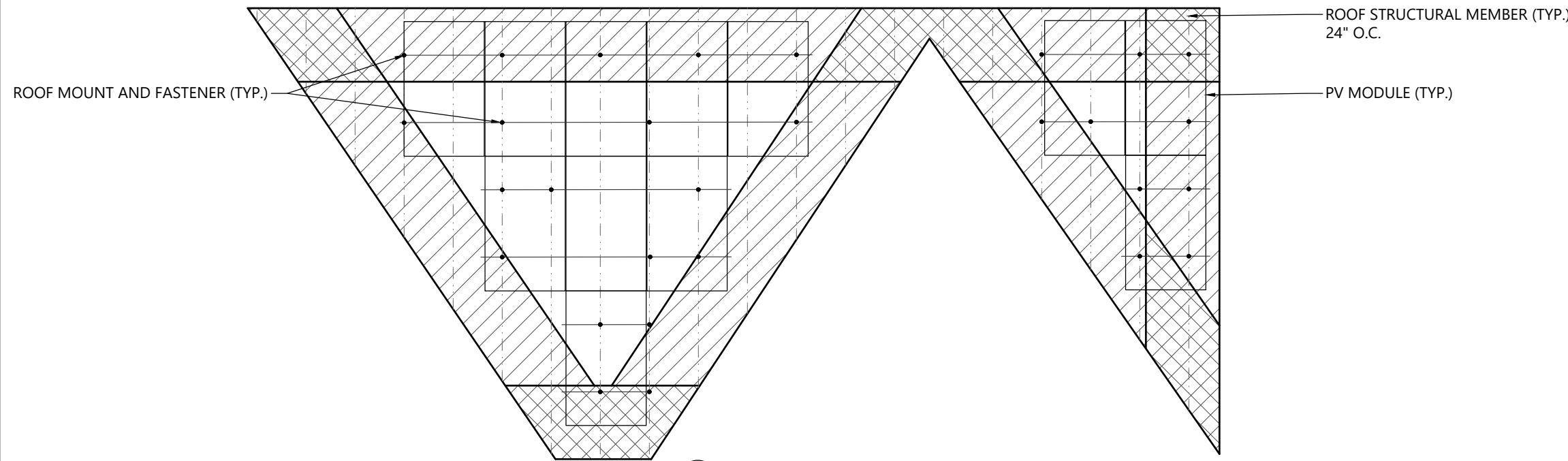

2 ARRAY LAYOUT
 3/16" = 1'-0"

© 2019 NC SOLAR NOW EXPRESSLY RESERVES ITS COMMON LAW COPYRIGHT AND OTHER PROPERTY RIGHTS IN THESE PLANS. THESE PLANS ARE NOT TO BE REPRODUCED, CHANGED OR COPIED IN ANY FORM OR MANNER WHATSOEVER, NOR ARE THEY TO BE ASSIGNED TO ANY THIRD PARTY WITHOUT FIRST OBTAINING THE EXPRESSED WRITTEN PERMISSION AND CONSENT OF NC SOLAR NOW.

CONDUCTOR SCHEDULE

TAG	CURRENT CARRYING CONDUCTORS			GROUNDING CONDUCTORS			CONDUIT/RACEWAY			NOTES
	QTY.	SIZE	INSULATION	QTY.	SIZE	INSULATION	QTY.	SIZE	LOCATION	
C1	4	10 AWG	PV WIRE	1	6 AWG	BARE	-	-	FREE AIR	1
C2	4	10 AWG	THWN	1	10 AWG	THWN	1	3/4"	EXT/INT	2,4
C3	3	8 AWG	THWN	1	10 AWG	THWN	1	3/4"	EXTERIOR	2,4
XC	-	-	-	-	-	-	-	-	-	3

NOTES:

1. MANUFACTURER PROVIDED, UL LISTED WIRING HARNESS FOR USE ON EXPOSED ROOFS
2. CONDUIT SIZE SHOWN IS CODE MINIMUM. LARGER SIZES ARE ALLOWED.
3. EXISTING CONDUCTORS, FIELD VERIFY
4. EQUIPMENT TERMINAL RATING SHALL BE A MINIMUM OF 75°C AT BOTH END OF CONDUCTOR
5. PLEASE REFERENCE NOTES ON PV-4 FOR ADDITIONAL DETAIL

PV MODULES

MAKE	REC
MODEL	REC 320NP BLACK
TECHNOLOGY	MONO-CRYST.
NOM. POWER (PNOM)	320 WATTS
NOM. VOLT. (VMP)	34.2 VOLTS
O.C. VOLT. (VOC)	40.8 VOLTS
MAX. SYS. VOLT.	1000 V (UL)
TEMP. COEF. (VTC)	-0.27 %/°C
NOM. CURR. (IMP)	9.37 AMPS
S.C. CURR. (ISC)	10.18 AMPS
MAX. SERIES FUSE	25 AMPS

MODULE OPTIMIZER

MAKE	SOLAREDEGE
MODEL	P320
DC INPUT:	
NOM. POWER	320 WATTS
VOLT. RANGE	8-48
MAX. CURR.	11.0 AMPS
DC OUTPUT:	
NOM. POWER	320 WATTS
MAX. VOLT.	60 VOLTS
MAX. CURR.	15 AMPS
MIN. STRING	8 OPTIMIZERS
MAX. STRING	25 OPTIMIZERS

DC/AC INVERTER

MAKE	SOLAREDEGE
MODEL	SE6000H-US
TECHNOLOGY	TRANSFORMER-LESS
DC INPUT:	
MAX. POWER	9300 WATTS
VOLT. RANGE	350-480 VOLTS
NOM. VOLT.	380 VOLTS
MAX. CURRENT	16.5 AMPS
STRING INPUTS	2 STRINGS
AC OUTPUT:	
NOM. POWER	6000 WATTS
NOM. VOLT.	240 VOLTS
MAX. POWER	6000 WATTS
MAX. CURR.	25 AMPS
GFP (Y/N)	YES
GFCI (Y/N)	YES
AFCI (Y/N)	YES
DC DISC. (Y/N)	YES
RAPID SHUTDOWN	YES
FUSE RATING	15 AMPS
PROTECT. RATING	NEMA 3R

JUNCTION BOX

MAKE	SOLADECK
MODEL	NA
PRO. RATING	NEMA 3R
VOLT. RATING	600 VOLTS
AMP RATING	120 AMPS
UL LISTING	UL 50

MD PANEL (EXISTING)

MAKE	CUTLER-HAMMER
MODEL	BR3040B200
ENCL. RATING	NEMA 3R
VOLT. RATING	240 VOLTS
BUS RATING	200 AMPS
UL LIST. (Y/N)	YES
MAIN BREAKER (Y/N)	YES
MAIN BREAKER RATING	200 AMPS

AC DISCONNECT

MAKE	GENERIC
MODEL	NA
ENCL. RATING	NEMA 3R
VOLT. RATING	240 VOLTS
AMP RATING	60 AMPS
UL LIST. (Y/N)	YES
FUSED (Y/N)	NO
FUSE RATING	N/A

- BACK-FEED SOLAR OUTPUT VIA 35A BREAKER AT THE OPPOSITE END OF THE BUS BAR FROM EXISTING POWER SOURCE
- MAIN BREAKER SERVES AS SERVICE DISCONNECT SWITCH
- LOAD-BREAK RATED
- VISIBLE OPEN
- LOCKABLE IN OPEN POSITION
- INSTALL ADJACENT TO METER
- DISCONNECT TO BE READILY ACCESSIBLE TO UTILITY COMPANY PERSONNEL AT ALL TIMES

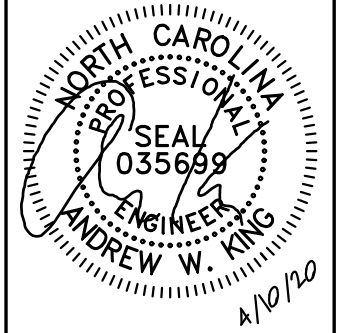

CLIENT INFO

EDWIN ALVARADO
195 MONTANA LANE
SPRING LAKE, NC 28390

PROJECT INFO

DC INPUT: 6.4 kW
AC EXPORT: 6.0 kW
DOI INSPT. METHOD: OPTION 2

CODE REFERENCES

NATION ELECTRICAL CODE v. 2017
NC FIRE PROTECTION CODE v. 2018
NC BUILDING CODE v. 2018
NC RESIDENTIAL CODE v. 2018
ACSE v. 7-10

SITE CONDITIONS

WIND SPEED: 118 MPH
RISK CATEGORY: II
EXPOSURE: B
SNOW: 10 PSF

SHEET INDEX

PV-1: COVER SHEET
PV-2: PV STRUCTURAL
PV-3: PV ELECTRICAL
PV-4: PV EQUIPMENT LABELS
PV-5: PV INSTALL GUIDE

DESIGN INFO

DESIGNER: CVV
ENGINEER: AWK
DATE: 04-06-2020
VERSION: P1

PV SYSTEM ELECTRICAL

PV-3.1

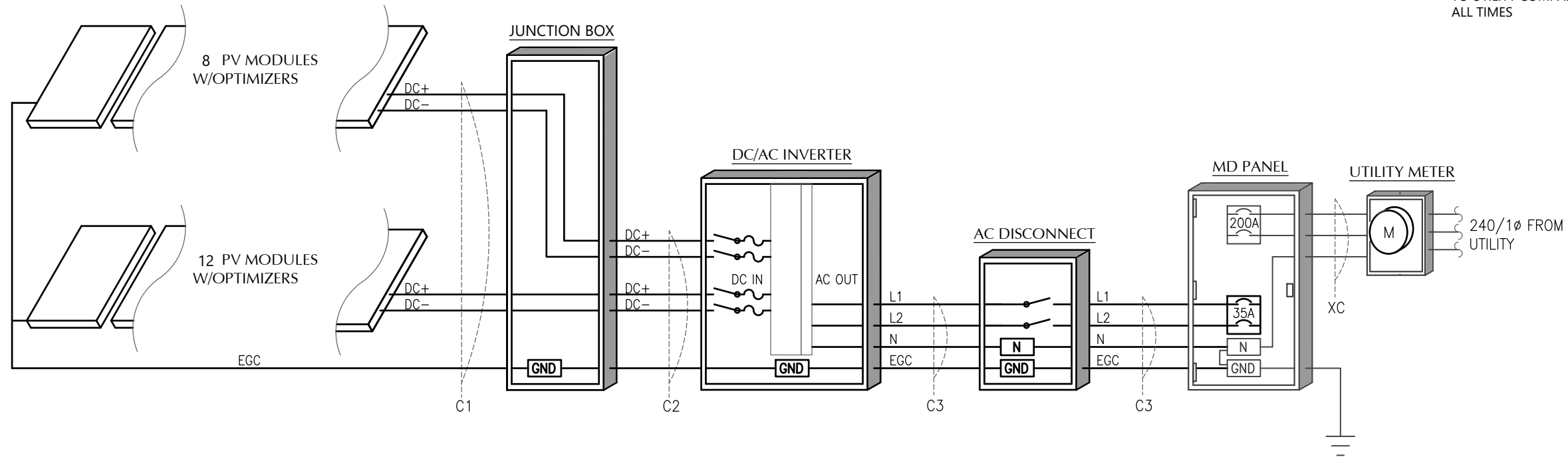

© 2019 NC SOLAR NOW EXPRESSLY RESERVES ITS COMMON LAW COPYRIGHT AND OTHER PROPERTY RIGHTS IN THESE PLANS. THESE PLANS ARE NOT TO BE REPRODUCED, CHANGED OR COPIED IN ANY FORM OR MANNER WHATSOEVER, NOR ARE THEY TO BE ASSIGNED TO ANY THIRD PARTY WITHOUT FIRST OBTAINING THE EXPRESSED WRITTEN PERMISSION AND CONSENT OF NC SOLAR NOW.

⚠ WARNING
ELECTRIC SHOCK HAZARD
 TERMINALS ON THE LINE AND LOAD SIDES MAY BE ENERGIZED IN THE OPEN POSITION

NEC 690.13 (B)
 PLACE ON PV SYSTEM DISCONNECTING MEANS.

⚠ WARNING
POWER SOURCE OUTPUT CONNECTION DO NOT RELOCATE THIS OVERCURRENT DEVICE

NEC 705.12 (B)(2)(3)(b)
 PLACE ADJACENT TO BACK-FED BREAKER

⚠ WARNING
DUAL POWER SUPPLY
 SOURCES: UTILITY GRID AND PV SOLAR ELECTRIC SYSTEM

NEC 705.12 (B)(3)
 PLACE ON ALL EQUIPMENT THAT IS SUPPLIED BY BOTH POWER SOURCES

WARNING: PHOTOVOLTAIC POWER SOURCE

NEC 690.31 (G)(3)&(4)
 PLACE ON ALL JUNCTION BOXES, EXPOSED RACEWAYS, AND OTHER WIRING METHODS EVERY 10' AND ON EVERY SECTION SEPARATED BY ENCLOSURES, WALLS, PARTITIONS, CEILINGS, OR FLOORS.

RAPID SHUTDOWN SWITCH FOR SOLAR PV SYSTEM

NEC 690.56 (C)(3)
 PLACE ON RAPID SHUTDOWN SWITCH OR EQUIPMENT WITH INTEGRATED RAPID SHUTDOWN *REFLECTIVE*

SOLAR PV SYSTEM EQUIPPED WITH RAPID SHUTDOWN

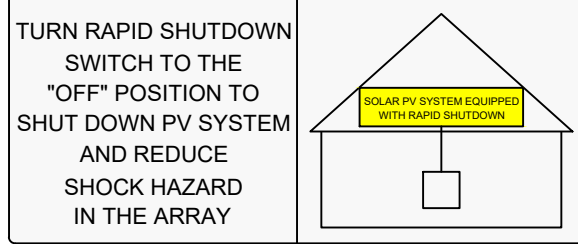

NEC 690.56 (C)(1)(a)
 PLACE WITHIN 3FT OF SERVICE DISCONNECTING MEANS TO WHICH THE PV SYSTEMS ARE CONNECTED AND SHALL INDICATE THE LOCATIONS OF RAPID SHUTDOWN SWITCHES

PV SYSTEM DISCONNECT

NEC 690.13 (B)
 PLACE ON PV SYSTEM DISCONNECTING MEANS.

PHOTOVOLTAIC POWER SOURCE
 OPERATING AC VOLTAGE 240 V
 MAXIMUM OPERATING AC OUTPUT CURRENT 25.0 A

NEC 690.54
 PLACE ON INTERCONNECTION DISCONNECTING MEANS

DIRECT CURRENT PHOTOVOLTAIC POWER SOURCE
 MAXIMUM VOLTAGE 600 VDC
 MAX CIRCUIT CURRENT 30.0 AMPS

NEC 690.53
 PLACE ON ALL DC DISCONNECTING MEANS

LABEL NOTES

1. LABELS SHOWN ARE HALF THEIR ACTUAL REQUIRED SIZE.
2. LABEL MATERIAL SHALL BE SUITABLE FOR THE EQUIPMENT ENVIRONMENT.
3. DC CONDUIT SHALL BE MARKED WITH REQUIRED LABEL EVERY 10 FEET.
4. LABELS WILL BE APPLIED IN ACCORDANCE WITH THE NEC. SOME LABELS MAY NOT BE NECESSARY.

DC WIRING NOTES

1. CONDUCTORS SHALL BE COPPER, RATED AT NOT LESS THAN 600 VOLTS FOR RESIDENTIAL CONSTRUCTION AND NOT LESS THAN 1000 VOLTS FOR COMMERCIAL CONSTRUCTION.
2. MINIMUM SIZE SHALL BE #10 AWG UNLESS OTHERWISE NOTED ON THE DRAWINGS.
3. EXPOSED WIRING CONDUCTOR INSULATION SHALL BE TYPE PV WIRE, USE-2, OR RHW-2 WHERE THE OUTER LAYER OF THE INSULATION IS UV, SUNLIGHT, AND MOISTURE RESISTANT.
6. EXTERIOR WIRING CONDUCTOR INSULATION SHALL BE TYPE THWN-2 AND INSTALLED IN ELECTRICAL METALLIC TUBING(EMT) OR RIGID POLYVINYL CHLORIDE CONDUIT(PVC). ALTERNATIVELY, METAL CLAD CABLE(MC) CAN BE USED AS WELL WHEN RATED FOR USE IN WET LOCATIONS.
7. INTERIOR WIRING CONDUCTOR INSULATION SHALL BE TYPE THHN-2 AND INSTALLED IN ELECTRICAL METALLIC TUBING(EMT), FLEXIBLE METAL CONDUIT(FMC), OR METAL CLAD CABLE(MC).
6. USE SCHEDULE 40 PVC OUTDOORS WHERE NOT SUBJECT TO PHYSICAL DAMAGE OR BELOW FLOOR SLAB. USE SCHEDULE 80 PVC OUTDOORS WHERE SUBJECT TO PHYSICAL DAMMAGE
7. MINIMUM CONDUIT SIZE TO BE 1/2".
8. WIRING METHODS TO CONFORM TO ARTICLES 330, 334, 348, 350, 352, 356, AND 358 OF THE 2017 NEC.

AC WIRING NOTES

1. CONDUCTORS SHALL BE COPPER RATED AT NOT LESS THAN 600 VOLTS.
2. MINIMUM SIZE SHALL BE #14 AWG UNLESS OTHERWISE NOTED ON THE DRAWINGS.
3. EXTERIOR WIRING CONDUCTOR INSULATION SHALL BE TYPE THWN AND INSTALLED IN ELECTRICAL METALLIC TUBING(EMT), RIGID POLYVINYL CHLORIDE CONDUIT(PVC), LIQUID-TIGHT FLEXIBLE METAL CONDUIT(LFMC), OR LIQUID-TIGHT FLEXIBLE NON-METALLIC CONDUIT(LFNC) . ALTERNATIVELY, METAL CLAD CABLE(MC) CAN BE USED AS WELL WHEN RATED FOR USE IN WET LOCATIONS.
4. INTERIOR WIRING CONDUCTOR INSULATION SHALL BE TYPE THHN AND INSTALLED IN ELECTRICAL METALLIC TUBING(EMT), FLEXIBLE METAL CONDUIT(FMC), METAL CLAD CABLE(MC), OR ROMEX.
5. USE SCHEDULE 40 PVC OUTDOORS WHERE NOT SUBJECT TO PHYSICAL DAMAGE OR BELOW FLOOR SLAB. USE SCHEDULE 80 PVC OUTDOORS WHERE SUBJECT TO PHYSICAL DAMMAGE
6. MINIMUM CONDUIT SIZE TO BE 1/2".
7. WIRING METHODS TO CONFORM TO ARTICLES 330, 334, 348, 350, 352, 356, AND 358 OF THE 2017 NEC.

CONSTRUCTION NOTES

1. ALL WORK IS TO BE PERFORMED IN ACCORDANCE WITH THE NEC, STATE, AND LOCAL APPLICABLE CODES.
2. FOLLOW MANUFACTURER'S INSTALLATION INSTRUCTIONS, BEST PRACTICES, AND SPECIFICATIONS.
3. ENSURE REQUIRED MAINTENANCE ACCESS AND CLEARANCES ARE MAINTAINED.
4. WIRES SHALL BE RATED AND LABELED "SUNLIGHT RESISTANT" WHERE EXPOSED TO AMBIENT CONDITIONS.
5. FUSES 0 - 600 AMPS SHALL BE UL CLASS "RK-1" LOW PEAK DUAL ELEMENT TIME DELAY WITH 200,000 AMPERE INTERRUPTING RATING AS MANUFACTURED BY BUSSMANN, UNLESS NOTED OTHERWISE.
6. ALL TERMINALS/LUGS SHALL BE 75° RATED. ALL TERMINALS, SPlicing CONNECTORS, LUGS, ETC SHALL BE IDENTIFIED FOR USE WITH THE MATERIAL (CU/AL) OF THE CONDUCTOR AND SHALL BE PROPERLY INSTALLED.
7. PROVIDE A PULLWIRE IN ALL EMPTY CONDUITS.
8. ALL PENETRATIONS THROUGH EXTERIOR ROOFS SHALL BE FLASHED IN A WATERPROOF MANNER.
9. SUPPORT ALL CONDUIT AND EQUIPMENT IN ACCORDANCE W/ NEC. ANY SUSPENDED MATERIALS SHALL BE DIRECTLY SUPPORTED BY THE BUILDING STRUCTURE.
10. METAL CONDUIT COUPLINGS CAN BE COMPRESSION TYPE, THREADED, OR BE SET-SCREW TYPE. PLASTIC CONDUIT COUPLINGS TO BE SOCKET GLUED TYPE.
11. A COMPLETE GROUNDING SYSTEM SHALL BE PRESENT OR PROVIDED AND INSTALLED IN ACCORDANCE WITH ARTICLE 250 OF THE NEC, AND AS SHOWN ON THE DRAWINGS.
12. EACH ELECTRICAL APPLIANCE SHALL BE PROVIDED WITH A NAMEPLATE GIVING THE IDENTIFYING NAME AND THE RATING IN VOLTS AND AMPERES, OR VOLTS AND WATTS. IF THE APPLIANCE IS TO BE USED ON A SPECIFIC FREQUENCY OR FREQUENCIES, IT SHALL BE SO MARKED. WHERE MOTOR OVERLOAD PROTECTION EXTERNAL TO THE APPLIANCES IS REQUIRED, THE APPLIANCE SHALL BE SO MARKED.
13. WHERE APPLICABLE, GROUNDING ELECTRODE CONDUCTOR TO BE CONTINUOUS. GROUNDING CRIMPS TO BE IRREVERSIBLE.
14. PHOTOVOLTAIC SYSTEMS SHALL BE PERMANENTLY MARKED AT VARIOUS EQUIPMENT LOCATIONS TO IDENTIFY THAT A PHOTOVOLTAIC SYSTEM IS INSTALLED AND THAT VARIOUS DANGERS ARE PRESENT.
15. EACH PHOTOVOLTAIC SYSTEM DISCONNECTING MEANS SHALL BE PERMANENTLY MARKED TO IDENTIFY IT AS A PHOTOVOLTAIC SYSTEM DISCONNECT.
16. WHERE ALL TERMINALS OF A DISCONNECTING MEANS MAY BE ENERGIZED IN THE OPEN POSITION, A WARNING SIGN SHALL BE MOUNTED ON OR ADJACENT TO THE DISCONNECT.
17. A PERMANENT LABEL FOR THE DIRECT-CURRENT PHOTOVOLTAIC POWER SOURCE SHALL BE PROVIDED AT THE DC DISCONNECT MEANS.
18. A PERMANENT PLAQUE OR DIRECTORY, DENOTING ALL ELECTRIC POWER SOURCES SERVING THE PREMISES, SHALL BE INSTALLED AT EACH SERVICE EQUIPMENT LOCATION AND AT LOCATIONS OF ALL POWER PRODUCTION SOURCES.
19. ALL MODULE GROUND CONNECTIONS SHALL BE MADE IN ACCORDANCE WITH NEC SECTION 690.4 (C)
20. A NORTH CAROLINA REGISTERED DESIGN PROFESSIONAL WILL BE REQUIRED TO SEAL THE STRUCTURAL DESIGN AT THE TIME OF PERMIT APPLICATION IF ANY OF THE FOLLOWING EXIST AND ARE ATTESTED TO BY THE APPLICANT:
 - I. THE WEIGHT OF THE PV SYSTEM EXCEEDS THREE (3) POUNDS PER SQUARE FOOT(PSF)
 - II. THE ROOF POSSESSES MORE THAN ONE (1) LAYER OF ASPHALT SHINGLES
 - III. THE ROOFING MATERIAL CONSISTS OF A TYPE OTHER THAN ASPHALT SHINGLES OR METAL
 - IV. THE ROOF IS LOCATED IN A 140 MPH OR GREATER WIND ZONE

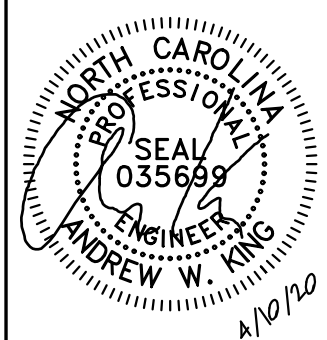
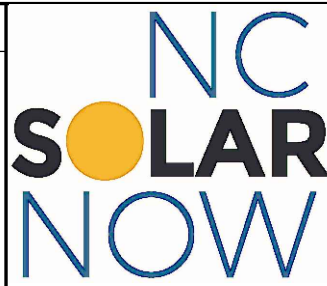

CLIENT INFO
 EDWIN ALVARADO
 195 MONTANA LANE
 SPRING LAKE, NC 28390

PROJECT INFO
 DC INPUT: 6.4 kW
 AC EXPORT: 6.0 kW
 DOI INSPT. METHOD: OPTION 2

CODE REFERENCES
 NATION ELECTRICAL CODE v. 2017
 NC FIRE PROTECTION CODE v. 2018
 NC BUILDING CODE v. 2018
 NC RESIDENTIAL CODE v. 2018
 ACSE v. 7-10

SITE CONDITIONS
 WIND SPEED: 118 MPH
 RISK CATEGORY: II
 EXPOSURE: B
 SNOW: 10 PSF

SHEET INDEX
 PV-1: COVER SHEET
 PV-2: PV STRUCTURAL
 PV-3: PV ELECTRICAL
 PV-4: PV EQUIPMENT LABELS
 PV-5: PV INSTALL GUIDE

DESIGN INFO
 DESIGNER: CVV
 ENGINEER: AWK
 DATE: 04-06-2020
 VERSION: P1

PV SYSTEM EQUIPMENT LABELS

PV-4.1

Single Phase Inverter with HD-Wave Technology

for North America

SE3000H-US / SE3800H-US / SE5000H-US / SE6000H-US /
SE7600H-US / SE10000H-US / SE11400H-US



Optimized installation with HD-Wave technology

- / Specifically designed to work with power optimizers
- / Record-breaking efficiency
- / Quick and easy inverter commissioning directly from a smartphone using the SolarEdge SetApp
- / Fixed voltage inverter for longer strings
- / Integrated arc fault protection and rapid shutdown for NEC 2014 and 2017, per article 690.11 and 690.12
- / UL1741 SA certified, for CPUC Rule 21 grid compliance
- / Extremely small
- / Built-in module-level monitoring
- / Outdoor and indoor installation
- / Optional: Revenue grade data, ANSI C12.20 Class 0.5 (0.5% accuracy)

/ Single Phase Inverter with HD-Wave Technology for North America

SE3000H-US / SE3800H-US / SE5000H-US / SE6000H-US/
SE7600H-US / SE10000H-US / SE11400H-US

Model Number	SE3000H-US	SE3800H-US	SE5000H-US	SE6000H-US	SE7600H-US	SE10000H-US	SE11400H-US	
APPLICABLE TO INVERTERS WITH PART NUMBER	SEXXXXH-XXXXXBXX4							
OUTPUT								
Rated AC Power Output	3000	3800 @ 240V 3300 @ 208V	5000	6000 @ 240V 5000 @ 208V	7600	10000	11400 @ 240V 10000 @ 208V	VA
Maximum AC Power Output	3000	3800 @ 240V 3300 @ 208V	5000	6000 @ 240V 5000 @ 208V	7600	10000	11400 @ 240V 10000 @ 208V	VA
AC Output Voltage Min.-Nom.-Max. (211 - 240 - 264)	✓	✓	✓	✓	✓	✓	✓	Vac
AC Output Voltage Min.-Nom.-Max. (183 - 208 - 229)	-	✓	-	✓	-	-	✓	Vac
AC Frequency (Nominal)	59.3 - 60 - 60.5 ⁽¹⁾							Hz
Maximum Continuous Output Current @240V	12.5	16	21	25	32	42	47.5	A
Maximum Continuous Output Current @208V	-	16	-	24	-	-	48.5	A
Power Factor	1, adjustable -0.85 to 0.85							
GFDI Threshold	1							A
Utility Monitoring, Islanding Protection, Country Configurable Thresholds	Yes							
INPUT								
Maximum DC Power @240V	4650	5900	7750	9300	11800	15500	17650	W
Maximum DC Power @208V	-	5100	-	7750	-	-	15500	W
Transformer-less, Ungrounded	Yes							
Maximum Input Voltage	480							Vdc
Nominal DC Input Voltage	380				400			Vdc
Maximum Input Current @240V ⁽²⁾	8.5	10.5	13.5	16.5	20	27	30.5	Adc
Maximum Input Current @208V ⁽²⁾	-	9	-	13.5	-	-	27	Adc
Max. Input Short Circuit Current	45							Adc
Reverse-Polarity Protection	Yes							
Ground-Fault Isolation Detection	600k Ω Sensitivity							
Maximum Inverter Efficiency	99	99.2						%
CEC Weighted Efficiency	99						99 @ 240V 98.5 @ 208V	%
Nighttime Power Consumption	< 2.5							W

⁽¹⁾ For other regional settings please contact SolarEdge support

⁽²⁾ A higher current source may be used; the inverter will limit its input current to the values stated

/ Single Phase Inverter with HD-Wave Technology for North America

SE3000H-US / SE3800H-US / SE5000H-US / SE6000H-US/
SE7600H-US / SE10000H-US / SE11400H-US

Model Number	SE3000H-US	SE3800H-US	SE5000H-US	SE6000H-US	SE7600H-US	SE10000H-US	SE11400H-US	
ADDITIONAL FEATURES								
Supported Communication Interfaces	RS485, Ethernet, ZigBee (optional), Cellular (optional)							
Revenue Grade Data, ANSI C12.20	Optional ⁽³⁾							
Inverter Commissioning	with the SetApp mobile application using built-in Wi-Fi Access Point for local connection							
Rapid Shutdown - NEC 2014 and 2017 690.12	Automatic Rapid Shutdown upon AC Grid Disconnect							
STANDARD COMPLIANCE								
Safety	UL1741, UL1741 SA, UL1699B, CSA C22.2, Canadian AFCI according to T.I.L. M-07							
Grid Connection Standards	IEEE1547, Rule 21, Rule 14 (HI)							
Emissions	FCC Part 15 Class B							
INSTALLATION SPECIFICATIONS								
AC Output Conduit Size / AWG Range	1" Maximum / 14-6 AWG			1" Maximum /14-4 AWG				
DC Input Conduit Size / # of Strings / AWG Range	1" Maximum / 1-2 strings / 14-6 AWG			1" Maximum / 1-3 strings / 14-6 AWG				
Dimensions with Safety Switch (HxWxD)	17.7 x 14.6 x 6.8 / 450 x 370 x 174			21.3 x 14.6 x 7.3 / 540 x 370 x 185			in / mm	
Weight with Safety Switch	22 / 10	25.1 / 11.4	26.2 / 11.9	38.8 / 17.6			lb / kg	
Noise	< 25			<50			dBA	
Cooling	Natural Convection							
Operating Temperature Range	-40 to +140 / -40 to +60 ⁽⁴⁾							°F / °C
Protection Rating	NEMA 4X (Inverter with Safety Switch)							

⁽³⁾ Revenue grade inverter P/N: SExxxxH-US000BNC4

⁽⁴⁾ Full power up to at least 50°C / 122°F; for power de-rating information refer to: <https://www.solaredge.com/sites/default/files/se-temperature-derating-note-na.pdf>

SOLAR'S MOST TRUSTED



REC N-PEAK BLACK SERIES

PREMIUM FULL BLACK MONO
N-TYPE SOLAR PANELS WITH
SUPERIOR PERFORMANCE



MONO N-TYPE: THE
MOST EFFICIENT C-SI
TECHNOLOGY



NO LIGHT INDUCED
DEGRADATION



SUPER-STRONG
FRAME UP TO 7000 PA
SNOW LOAD



FLEXIBLE
INSTALLATION
OPTIONS



IMPROVED
PERFORMANCE IN
SHADED CONDITIONS



GUARANTEED HIGH
POWER OVER LIFETIME

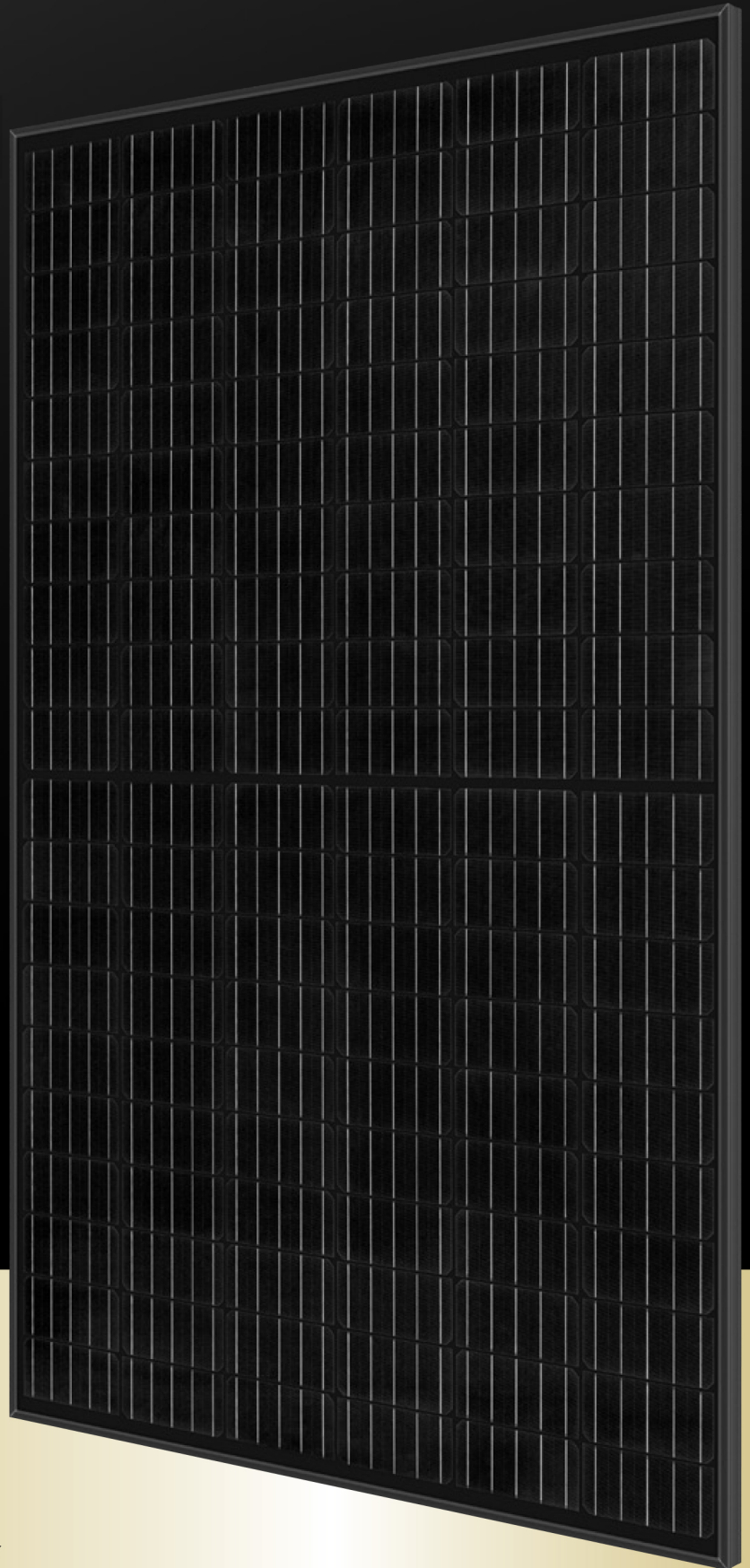

325 W_P POWER

20 YEAR PRODUCT
WARRANTY

0.5% ANNUAL DEGRADATION OVER
25-YEAR POWER WARRANTY

REC N-PEAK BLACK SERIES

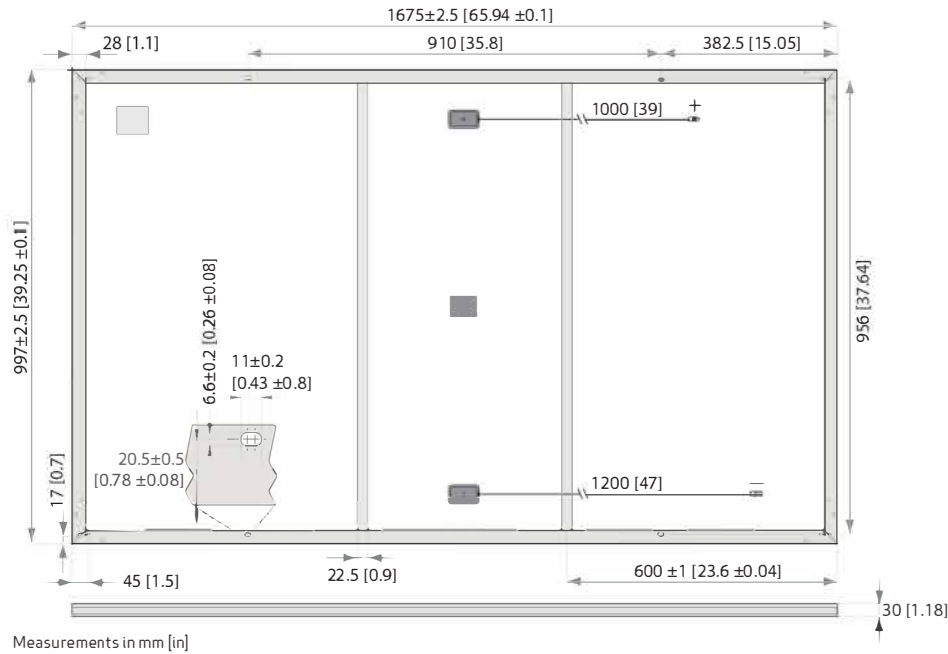

GENERAL DATA

Cell type:	120 half cut n-type mono c-Si cells 6 strings of 20 cells in series
Glass:	0.13" (3.2 mm) solar glass with anti-reflection surface treatment
Backsheet:	Highly reflective and resistant polymeric construction (black)
Frame:	Anodized aluminum (black)
Junction box:	3-part, 3 bypass diodes, IP67 rated in accordance with IEC 62790
Cable:	12 AWG (4 mm ²) PV wire, 39 + 47" (1 m + 1.2 m) in accordance with EN 50618
Connectors:	Stäubli MC4 PV-KBT4/KST4, 12 AWG (4 mm ²) IP68 only when connected
Origin:	Made in Singapore

MECHANICAL DATA

Dimensions:	65.9 x 39.25 x 1.1" (1675 x 997 x 30 mm)
Area:	17.98 ft ² (1.67 m ²)
Weight:	39.7 lbs (18 kg)

ELECTRICAL DATA @ STC

Product code*: RECxxxNP BLACK

Nominal Power - P _{MPP} (Wp)	310	315	320	325
Watt Class Sorting - (W)	-0/+5	-0/+5	-0/+5	-0/+5
Nominal Power Voltage - V _{MPP} (V)	33.6	33.9	34.2	34.4
Nominal Power Current - I _{MPP} (A)	9.24	9.31	9.37	9.46
Open Circuit Voltage - V _{OC} (V)	40.2	40.5	40.8	41.0
Short Circuit Current - I _{SC} (A)	10.01	10.09	10.18	10.27
Panel Efficiency (%)	18.6	18.9	19.2	19.5

Values at standard test conditions (STC: air mass AM1.5, irradiance 1000 W/m², temperature 25°C), based on a production spread with a tolerance of V_{OC} & I_{SC} ±3% within one watt class. * Where xxx indicates the nominal power class (P_{MPP}) at STC above.

ELECTRICAL DATA @ NOCT

Product code*: RECxxxNP BLACK

Nominal Power - P _{MPP} (Wp)	234	238	241	245
Nominal Power Voltage - V _{MPP} (V)	31.1	31.4	31.7	31.9
Nominal Power Current - I _{MPP} (A)	7.51	7.56	7.62	7.69
Open Circuit Voltage - V _{OC} (V)	37.3	37.5	37.8	38.0
Short Circuit Current - I _{SC} (A)	8.01	8.07	8.14	8.22

Nominal operating cell temperature (NOCT: air mass AM1.5, irradiance 800 W/m², temperature 20°C, windspeed 1 m/s).

* Where xxx indicates the nominal power class (P_{MPP}) at STC above.

CERTIFICATIONS



Pending: UL 1703 (Fire type 2), IEC 61215, IEC 61730, IEC 62804 (PID), IEC 61701 (Salt Mist), IEC 62716 (Ammonia), ISO 9001: 2015, ISO 14001: 2004, OHSAS 18001: 2007

WARRANTY

20 year product warranty
25 year linear power output warranty, maximum
degression in performance of 0.5% p.a., giving
86% at end of year 25.
See warranty conditions for further details.

MAXIMUM RATINGS

Operational temperature:	-40 ... +85°C
Maximum system voltage:	1000 V
Design load (+): snow	4666 Pa (97.5 lbs/ft ²)*
Maximum test load (+):	7000 Pa (146 lbs/ft ²)*
Design load (-): wind	1600 Pa (33.4 lbs/ft ²)*
Maximum test load (-):	2400 Pa (50 lbs/ft ²)*
Max series fuse rating:	25 A
Max reverse current:	25 A

* Calculated using a safety factor of 1.5
* See installation manual for mounting instructions

TEMPERATURE RATINGS *

Nominal Operating Cell Temperature:	44°C (±2°C)
Temperature coefficient of P _{MPP} :	-0.35 %/°C
Temperature coefficient of V _{OC} :	-0.27 %/°C
Temperature coefficient of I _{SC} :	0.04 %/°C

* The temperature coefficients stated are linear values

LOW LIGHT BEHAVIOUR

Typical low irradiance performance of module at STC.

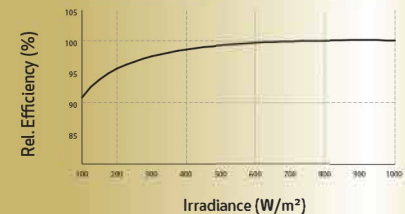

Founded in Norway in 1996, REC is a leading vertically integrated solar energy company. Through integrated manufacturing from silicon to wafers, cells, high-quality panels and extending to solar solutions, REC provides the world with a reliable source of clean energy. REC's renowned product quality is supported by the lowest warranty claims rate in the industry. REC is a Bluestar Elkem company with headquarters in Norway and operational headquarters in Singapore. REC employs more than 2,000 people worldwide, producing 1.5 GW of solar panels annually.



www.recgroup.com