







ENGINEER:  
  
**MODEL ENERGY**  
 300 FAYETTEVILLE ST.  
 #1430  
 RALEIGH, NC 27602  
 919-274-9905  
 MODELENERGY.COM  
 P-1194

JOB TITLE:  
**NEW SOLAR PV SYSTEM**  
 10.23 KW DC INPUT  
 10.00 KW AC EXPORT  
**RANDALL MADRIGAL**  
 1802 NC 27 E  
 LILLINGTON NC 27546

CONSTRUCTION NOTES	
1.	ALL WORK AND EQUIPMENT SHALL BE INSTALLED IN ACCORDANCE WITH THE LATEST NATIONAL, STATE, AND LOCAL CODES AND ORDINANCES
2.	FOLLOW MANUFACTURER'S INSTALLATION INSTRUCTIONS, BEST PRACTICES, AND SPECIFICATIONS
3.	WIRES SHALL BE RATED AND LABELED 'SUNLIGHT RESISTANT' WHERE EXPOSED TO AMBIENT CONDITIONS
4.	THE PHOTOVOLTAIC SYSTEM SHALL NOT EXCEED 600 VOLTS OR 800 AMPS
5.	EACH ELECTRICAL APPLIANCE SHALL BE PROVIDED WITH A NAMEPLATE GIVING THE IDENTIFYING NAME AND THE RATING IN VOLTS AND AMPERES, OR VOLTS AND WATTS. IF THE APPLIANCE IS TO BE USED ON A SPECIFIC FREQUENCY OR FREQUENCIES, IT SHALL BE SO MARKED. WHERE MOTOR OVERLOAD PROTECTION EXTERNAL TO THE APPLIANCES IS REQUIRED, THE APPLIANCE SHALL BE SO MARKED
6.	WHERE APPLICABLE, GROUNDING ELECTRODE CONDUCTOR TO BE CONTINUOUS. GROUNDING CRIMPS TO BE IRREVERSIBLE
7.	GROUNDING DC PHOTOVOLTAIC ARRAYS SHALL BE PROVIDED WITH DC GROUND-FAULT PROTECTION THAT MEETS THE REQUIREMENTS OF NEC SECTION 690.5. UNGROUNDED DC PHOTOVOLTAIC ARRAYS SHALL COMPLY WITH NEC SECTION 690.35
8.	IN ONE- AND TWO-FAMILY DWELLINGS, LIVE PARTS IN PHOTOVOLTAIC SOURCE CIRCUITS AND PHOTOVOLTAIC OUTPUT CIRCUITS OVER 150 VOLTS TO GROUND, SHALL ONLY BE ACCESSIBLE TO QUALIFIED PERSONS WHILE ENERGIZED.
9.	PHOTOVOLTAIC SYSTEMS SHALL BE PERMANENTLY MARKED AT VARIOUS EQUIPMENT LOCATIONS TO IDENTIFY THAT A PHOTOVOLTAIC SYSTEM IS INSTALLED AND THAT VARIOUS DANGERS ARE PRESENT.
10.	EACH PHOTOVOLTAIC SYSTEM DISCONNECTING MEANS SHALL BE PERMANENTLY MARKED TO IDENTIFY IT AS A PHOTOVOLTAIC SYSTEM DISCONNECT
11.	WHERE ALL TERMINALS OF A DISCONNECTING MEANS MAY BE ENERGIZED IN THE OPEN POSITION, A WARNING SIGN SHALL BE MOUNTED ON OR ADJACENT TO THE DISCONNECT
12.	A PERMANENT LABEL FOR THE DIRECT-CURRENT PHOTOVOLTAIC POWER SOURCE SHALL BE PROVIDED BY THE INSTALLED AT THE DC DISCONNECT MEANS
13.	A PERMANENT PLAQUE OR DIRECTORY, DENOTING ALL ELECTRIC POWER SOURCES SERVING THE PREMISES, SHALL BE INSTALLED AT EACH SERVICE EQUIPMENT LOCATION AND AT LOCATIONS OF ALL POWER PRODUCTION SOURCES.
14.	A PERMANENT PLAQUE OR DIRECTORY SHALL BE PROVIDED DENOTING THE LOCATIONS OF THE SERVICE DISCONNECT MEANS AND THE PHOTOVOLTAIC SYSTEM DISCONNECT MEANS IF THEY ARE NOT LOCATED AT THE SAME LOCATION.
15.	ALL MODULE GROUND CONNECTIONS SHALL BE MADE IN ACCORDANCE WITH NEC SECTION 690.4 (C)

ABBREVIATIONS	
A	AMPERE
AC	ALTERNATING CURRENT
DC	DIRECT CURRENT
EGC	EQUIPMENT GROUNDING CONDUCTOR
EMT	ELECTRICAL METAL TUBING
GALV	GALVANIZED
GEC	GROUNDING ELECTRODE CONDUCTOR
GND	GROUND
I	CURRENT
IMP	CURRENT AT MAXIMUM POWER
Isc	SHORT-CIRCUIT CURRENT
kVA	KILOVOLT AMPERE
kW	KILOWATT
MAX	MAXIMUM
MIN	MINIMUM
MCB	MAIN CIRCUIT BREAKER
MLO	MAIN LUG ONLY
NOM	NOMINAL
NTS	NOT TO SCALE
PNOM	NOMINAL POWER
PV	PHOTOVOLTAIC
PVC	POLYVINYL CHLORIDE
SN	SOLAR NOON
STC	STANDARD TEST CONDITIONS
TYP	TYPICAL
V	VOLT
VMP	VOLTAGE AT MAXIMUM POWER
Voc	OPEN-CIRCUIT VOLTAGE
W	WATT

CODE REFERENCES	
2017 NATIONAL ELECTRIC CODE 2018 NORTH CAROLINA BUILDING CODE 2018 NORTH CAROLINA RESIDENTIAL CODE 2018 NORTH CAROLINA FIRE CODE	
SHEET INDEX	
PV1.1 - PROJECT INFORMATION PV2.1 - SITE & STRUCTURAL INFORMATION PV2.2 - SITE & STRUCTURAL INFORMATION PV3.1 - ELECTRICAL INFORMATION PV4.1 - EQUIPMENT LABELS	
SITE CONDITIONS	
ASCE 7-10 WIND SPEED - 115 MPH EXPOSURE CATEGORY - B RISK CATEGORY - II	
LEGEND	
	DISCONNECT SWITCH
	FUSE
	CIRCUIT BREAKER
	EQUIP. GROUND

CLIENT:  
  
 ISSUED FOR:   
 CONSTRUCTION 07/15/19  
 DATE:  
 PROJECT INFORMATION  
**PV1.1**

1 SITE & STRUCTURAL PLAN

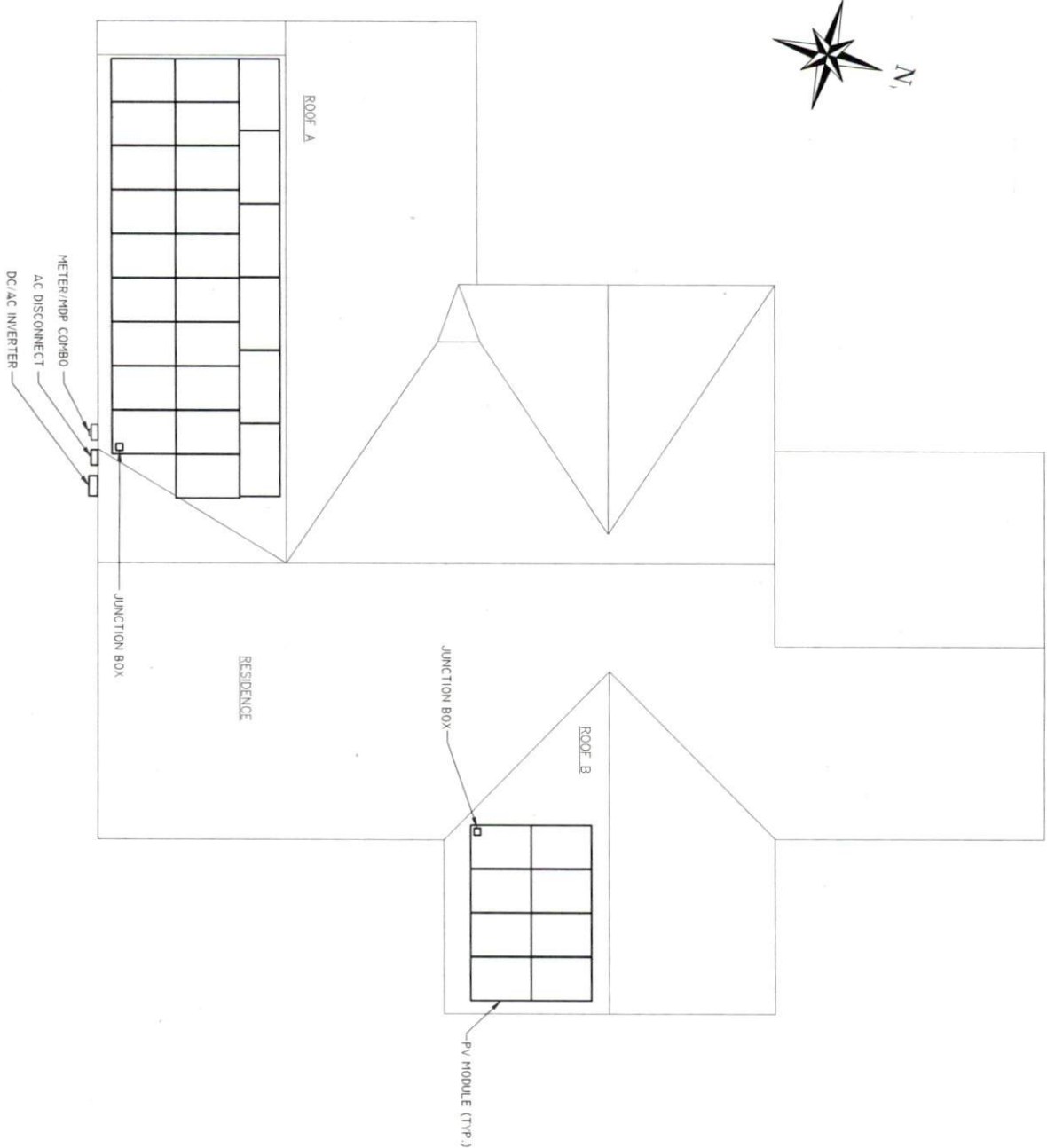

SCALE : 1/8" = 1'-0"

PV2.1

ISSUED FOR: DATE:  
 CONSTRUCTION: 07/15/19



CLIENT:

NEW SOLAR PV SYSTEM  
 10.23 kW DC INPUT  
 10.00 kW AC EXPORT  
 RANDALL MADRIGAL  
 1802 NC 27 E  
 LILLINGTON NC 27546

JOB TITLE:

MODEL ENERGY  
 300 FAYETTEVILLE ST.  
 #1430  
 RALEIGH, NC 27602  
 919-274-9905  
 MODELENERGY.COM  
 P1194



ENGINEER:

ROOF "B" MOUNT & FASTENER	
ROOF MOUNT	
MAKE	SOLAR ROOF HOOK
MODEL	L-FOOT
MATERIAL	ALUMINUM
FASTENER	
MAKE	SOLAR ROOF HOOK
MODEL	QUICKBOLT
MATERIAL	304 SS
SIZE	5/16-18 X 5.25"
GENERAL	
WEIGHT	1 LBS
FASTENERS PER MOUNT	1
MAX. PULL-OUT FORCE	960 LBS. / MOUNT
SAFETY FACTOR	2.0
DESIGN PULL-OUT FORCE	480 LBS. / MOUNT

ROOF "B" MOUNT & FASTENER	
ROOF MOUNT	
MAKE	SOLAR ROOF HOOK
MODEL	L-FOOT
MATERIAL	ALUMINUM
FASTENER	
MAKE	SOLAR ROOF HOOK
MODEL	QUICKBOLT
MATERIAL	304 SS
SIZE	5/16-18 X 5.25"
GENERAL	
WEIGHT	1 LBS
FASTENERS PER MOUNT	1
MAX. PULL-OUT FORCE	960 LBS. / MOUNT
SAFETY FACTOR	2.0
DESIGN PULL-OUT FORCE	480 LBS. / MOUNT

PV MODULES	
MAKE	SILFAB
MODEL	SLA-M310
WIDTH	39"
LENGTH	65"
THICKNESS	1.5"
WEIGHT	41.9 LBS

MOUNTING RAILS ROOF "B"	
MAKE	IRONRIDGE
MODEL	XR100
MATERIAL	ALUMINUM
WEIGHT	1.25 LBS. /SQFT
SPACING	34 IN.

ARRAY "B" SUMMARY	
# MODULES	8
MOD. ATT. MID	12
MOD. ATT. END	8
ROOF MOUNTS	19
RAIL LENGTH	55 FT.
ARRAY AREA	141 SQFT
ARRAY WEIGHT	535 LBS
AZIMUTH @ SN	161°
TILT ANGLE	34°

ROOF "A" SUMMARY	
STRUCTURE	
TYPE	RAFTERS
MATERIAL	SOUTHERN PINE #2
SIZE	2" X 8"
SPACING	16" o.c.
EFF. SPAN	20' 0"
PITCH	5 / 12
DENSITY	30 LBS. /CU.FT.
DECKING	
TYPE	OSB
MATERIAL	WOOD COMPOSITE
THICKNESS	7/16"
WEIGHT	1.6 LBS. /SQFT
ROOFING	
TYPE	ARCH SHINGLE
MATERIAL	ASPHALT
WEIGHT	2.3 LBS. /SQFT

ROOF "D" SUMMARY	
STRUCTURE	
TYPE	TRUSSES
MATERIAL	SOUTHERN PINE #2
SIZE	2" X 8"
SPACING	16" o.c.
EFF. SPAN	11' 6"
PITCH	8 / 12
DENSITY	30 LBS. /CU.FT.
DECKING	
TYPE	OSB
MATERIAL	WOOD COMPOSITE
THICKNESS	7/16"
WEIGHT	1.6 LBS. /SQFT
ROOFING	
TYPE	ARCH SHINGLE
MATERIAL	ASPHALT
WEIGHT	2.3 LBS. /SQFT

ROOF "A" ZONES (PORTRAIT AND LANDSCAPE)	
ALL ZONES	MAX. OVERHANG = 12"
ZONE 1	MAX. FASTENER SPAN ZONE 1 = 64'
ZONE 2	MAX. FASTENER SPAN ZONE 2 = 48'
ZONE 3	MAX. FASTENER SPAN ZONE 3 = 16'

ROOF "B" ZONES	
ALL ZONES	MAX. OVERHANG = 12"
ZONE 1	MAX. FASTENER SPAN ZONE 1 = 64'
ZONE 2	MAX. FASTENER SPAN ZONE 2 = 48'
	MAX. FASTENER SPAN ZONE 3 = 16'

ROOF "A" LOADING (PORTRAIT)	
GROUND SNOW LOAD	15 LBS. /SQFT.
LIVE LOAD	20 LBS. /SQFT.
DEAD LOAD	
ROOFING	3.9 LBS. /SQFT.
PV ARRAY	2.5 LBS. /SQFT.
TOTAL	6.4 LBS. /SQFT.
WIND LOAD	
UPLIFT ZONE 1	-23.0 LBS. /SQFT.
UPLIFT ZONE 2	-58.0 LBS. /SQFT.
UPLIFT ZONE 3	-57.1 LBS. /SQFT.
DOWNWARD	13.6 LBS. /SQFT.
FASTENER LOAD	
UPLIFT ZONE 1	-332 LBS.
UPLIFT ZONE 2	-412 LBS.
UPLIFT ZONE 3	-206 LBS.
DOWNWARD	196 LBS.

ROOF "A" LOADING (LANDSCAPE)	
GROUND SNOW LOAD	15 LBS. /SQFT.
LIVE LOAD	20 LBS. /SQFT.
DEAD LOAD	
ROOFING	3.9 LBS. /SQFT.
PV ARRAY	2.5 LBS. /SQFT.
TOTAL	6.4 LBS. /SQFT.
WIND LOAD	
UPLIFT ZONE 1	-23.0 LBS. /SQFT.
UPLIFT ZONE 2	-58.0 LBS. /SQFT.
UPLIFT ZONE 3	-57.1 LBS. /SQFT.
DOWNWARD	13.6 LBS. /SQFT.
FASTENER LOAD	
UPLIFT ZONE 1	-199 LBS.
UPLIFT ZONE 2	-247 LBS.
UPLIFT ZONE 3	-124 LBS.
DOWNWARD	118 LBS.

ROOF "B" LOADING	
GROUND SNOW LOAD	15 LBS. /SQFT.
LIVE LOAD	20 LBS. /SQFT.
DEAD LOAD	
ROOFING	3.9 LBS. /SQFT.
PV ARRAY	2.5 LBS. /SQFT.
TOTAL	6.4 LBS. /SQFT.
WIND LOAD	
UPLIFT ZONE 1	-24.6 LBS. /SQFT.
UPLIFT ZONE 2	-29.0 LBS. /SQFT.
UPLIFT ZONE 3	-29.0 LBS. /SQFT.
DOWNWARD	23.0 LBS. /SQFT.
FASTENER LOAD	
UPLIFT ZONE 1	-355 LBS.
UPLIFT ZONE 2	-314 LBS.
UPLIFT ZONE 3	-105 LBS.
DOWNWARD	332 LBS.

ARRAY "A" SUMMARY	
# MODULES	25
MOD. ATT. MID	44
MOD. ATT. END	12
ROOF MOUNTS	54
RAIL LENGTH	180 FT.
ARRAY AREA	440 SQFT.
ARRAY WEIGHT	1048 LBS
AZIMUTH @ SN	161°
TILT ANGLE	22°

**STATEMENT OF STRUCTURAL COMPLIANCE**

THE EXISTING ROOF STRUCTURE HAS BEEN DESIGNED TO SUPPORT THE ADDITIONAL LOADS OF THE PURPOSED PV SYSTEM. IN ADDITION, THE RACKING AND FASTENING SYSTEM SHALL BE CAPABLE OF SECURING THE SYSTEM TO THE STRUCTURE UNDER DESIGN CONDITIONS WHEN INSTALLED PROPERLY AND IN ACCORDANCE WITH THE RACKING AND FASTENING ARRANGEMENT DETAILED WITHIN THESE DRAWINGS.

SIGNED: 

NAME: ANDREW W. KING, PE

TITLE: PROFESSIONAL ENGINEER

ENGINEER:



**MODEL ENERGY**

300 FAYETTEVILLE ST.  
#1430  
RALEIGH, NC 27602  
919-274-9905  
MODELENERGY.COM

P-1194

JOB TITLE:

**NEW SOLAR PV SYSTEM**  
10.23 KW DC INPUT  
10.00 KW AC EXPORT

**RANDALL MADRIGAL**  
1802 NC 27 E  
LILLINGTON NC 27546

CLIENT:



ISSUED FOR: CONSTRUCTION DATE: 07/15/19

SITE & STRUCTURAL INFORMATION

**PV2.2**

© 2019 MODEL ENERGY, PLLC EXPRESSLY RESERVES ITS COMMON LAW COPYRIGHT AND OTHER PROPERTY RIGHTS IN THESE PLANS. THESE PLANS ARE NOT TO BE REPRODUCED, CHANGED OR COPIED IN ANY FORM OR MANNER WHATSOEVER, NOR ARE THEY TO BE ASSIGNED TO ANY THIRD PARTY WITHOUT FIRST OBTAINING THE EXPRESSED WRITTEN PERMISSION AND CONSENT OF MODEL ENERGY, PLLC.

PV MODULES	
MAKE	SILFAB
MODEL	SLA-M510
TECHNOLOGY	MONO-CRYST.
NOM. POWER (P <sub>NOM</sub> )	310 WATTS
NOM. VOLT (V <sub>MP</sub> )	33.05 VOLTS
O.C. VOLT (V <sub>OC</sub> )	40.25 VOLTS
MAX. SYS. VOLT	1000 V (UL)
TEMP. COEF. (V <sub>TC</sub> )	-0.30 %/°C
NOM. CURR. (I <sub>MP</sub> )	9.38 AMPS
S.C. CURR. (I <sub>SC</sub> )	9.93 AMPS
MAX. SERIES FUSE	20 AMPS

MODULE OPTIMIZER	
MAKE	SOLAREEDGE
MODEL	P320
DC INPUT:	
NOM. POWER	320 WATTS
VOLT. RANGE	8-48
MAX. CURR.	11.0 AMPS
DC OUTPUT:	
NOM. POWER	320 WATTS
MAX. VOLT.	60 VOLTS
MAX. CURR.	15 AMPS
MIN. STRING	8 OPTIMIZERS
MAX. STRING	25 OPTIMIZERS
MAX. POWER	5700 WATTS

JUNCTION BOX	
MAKE	SOLADECK
MODEL	0785-3R
PRO. RATING	NEMA 3R
VOLT. RATING	600 VOLTS
AMP RATING	120 AMPS
UL LISTING	UL 50

CONDUCTOR SCHEDULE													
TAG	CURRENT CARRYING CONDUCTORS				GROUNDING CONDUCTORS				CONDUIT/RACEWAY			NOTES	
	QTY.	SIZE	MATERIAL	INSULATION	QTY.	SIZE	MATERIAL	INSULATION	QTY.	SIZE	MATERIAL		LOCATION
C1	2	10 AWG	COPPER	PV WIRE	1	6 AWG	COPPER	PV WIRE	-	-	-	FREE AIR	1
C2	2	10 AWG	COPPER	THWN-2	1	10 AWG	COPPER	THWN-2	1	1/2"	FMC/EMT	EXT/INT	2.4
C3	3	6 AWG	COPPER	THWN	1	10 AWG	COPPER	THWN	1	3/4"	EMT	EXT	2.4
XC	-	-	-	-	-	-	-	-	-	-	-	-	3

**NOTES:**

1. MANUFACTURER PROVIDED, UL LISTED WIRING HARNESS FOR USE ON EXPOSED ROOFS
2. CONDUIT SIZE SHOWN IS CODE MINIMUM. LARGER SIZES ARE ALLOWED.
3. EXISTING CONDUCTORS, FIELD VERIFY
4. EQUIPMENT TERMINAL RATING SHALL BE A MINIMUM OF 75°C AT BOTH END OF CONDUCTOR

DC/AC INVERTER	
MAKE	SOLAREEDGE
MODEL	SE10000H-US
TECHNOLOGY	TRANS-LESS
DC INPUT:	
MAX. POWER	15500 WATTS
MAX. VOLT.	480 VOLTS
NOM. VOLT.	380 VOLTS
MAX. CURRENT	27 AMPS
MAX. SCC	45 AMPS
STRINGS INPUTS	3 STRINGS
AC OUTPUT:	
RATED POWER	10000 WATTS
MAX. POWER	10000 WATTS
NOM. VOLT.	240 VOLTS
MAX. CURR.	42 AMPS
GFP (Y/N)	YES
RPP (Y/N)	YES
GFCL (Y/N)	YES
AFCL (Y/N)	YES
DC DISC. (Y/N)	YES
RAPID SHUTDOWN	AUTOMATIC
FUSE RATING	15 AMPS
PROTECT. RATING	NEMA 4X

AC DISCONNECT	
MAKE	GENERIC
MODEL	N/A
ENCL. RATING	NEMA 3R
VOLT. RATING	240 VOLTS
AMP RATING	60 AMPS
UL LIST (Y/N)	YES
FUSED (Y/N)	YES
FUSE RATING	60 AMPS

**NOTES:**

- LOAD-BREAK RATED
- VISIBLE OPEN
- LOCKABLE IN OPEN POSITION
- INSTALL ADJACENT TO METER
- DISCONNECT TO BE READILY ACCESSIBLE TO UTILITY COMPANY PERSONNEL AT ALL TIMES

MD PANEL (EXISTING)	
MAKE	SQUARE D
MODEL	N/A
ENCL. RATING	NEMA 3R
VOLT. RATING	240 VOLTS
BUS RATING	200 AMPS
UL LIST (Y/N)	YES
MAIN BREAKER (Y/N)	YES
BREAKER RATING	175 AMPS

**NOTES:**

- BACK-FEED SOLAR OUTPUT VIA FEEDER TAP INSIDE OF PANEL.
- MAIN BREAKER SERVES AS SERVICE DISCONNECT SWITCH.
- REPLACE MAIN BREAKER WITH NEW 175A BREAKER.

SUB PANEL (EXISTING)	
MAKE	SQUARE D
MODEL	N/A
ENCL. RATING	NEMA 3R
VOLT. RATING	240 VOLTS
BUS RATING	200 AMPS
UL LIST (Y/N)	YES
MAIN BREAKER (Y/N)	NO
BREAKER RATING	N/A

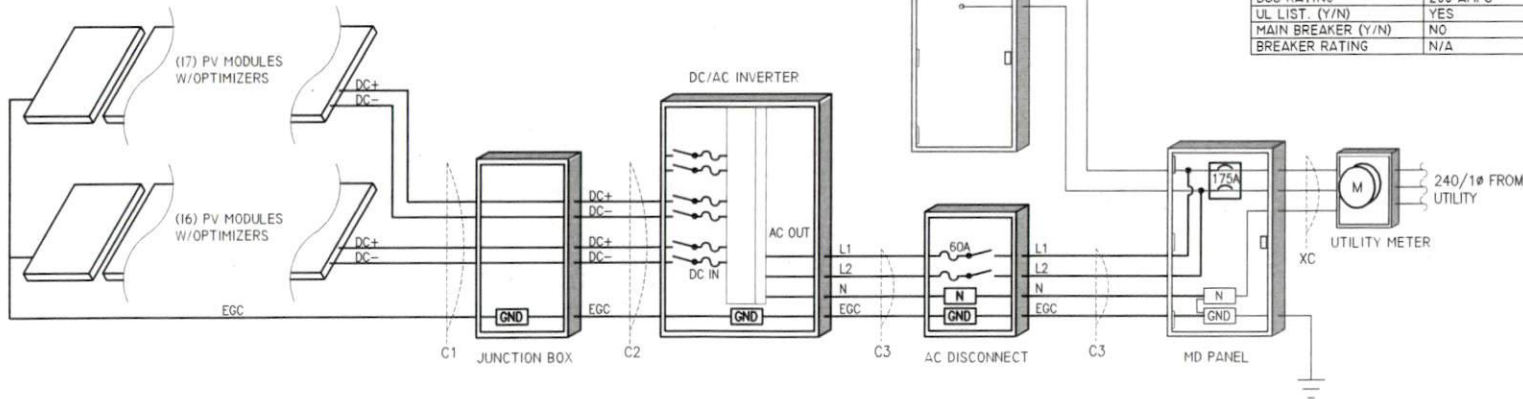

ENGINEER:



**MODEL ENERGY**

300 FAYETTEVILLE ST.  
#1430  
RALEIGH, NC 27602  
919-274-9905  
MODELENERGY.COM

P-1194

JOB TITLE:

**NEW SOLAR PV SYSTEM**  
10.23 KW DC INPUT  
10.00 KW AC EXPORT  
**RANDALL MADRIGAL**  
1802 NC 27 E  
LILLINGTON NC 27546

CLIENT:



ISSUED FOR: CONSTRUCTION  
DATE: 07/15/19

ELECTRICAL INFORMATION

**PV3.1**

**⚠ WARNING**  
**ELECTRIC SHOCK HAZARD**  
 TERMINALS ON THE LINE AND  
 LOAD SIDES MAY BE ENERGIZED  
 IN THE OPEN POSITION

NEC 690.13 (B)  
 PLACE ON PV SYSTEM DISCONNECTING MEANS.

**⚠ WARNING**  
**POWER SOURCE  
 OUTPUT CONNECTION  
 DO NOT RELOCATE THIS  
 OVERCURRENT DEVICE**

NEC 705.12 (B)(2)(3)(b)  
 PLACE ADJACENT TO BACK-FED BREAKER

**⚠ WARNING**  
**DUAL POWER SUPPLY**  
**SOURCES: UTILITY GRID AND  
 PV SOLAR ELECTRIC SYSTEM**

NEC 705.12 (B)(3)  
 PLACE ON ALL EQUIPMENT THAT IS SUPPLIED  
 BY BOTH POWER SOURCES

**RAPID SHUTDOWN  
 SWITCH FOR  
 SOLAR PV SYSTEM**

NEC 690.56 (C)(3)  
 PLACE ON RAPID SHUTDOWN SWITCH OR EQUIPMENT  
 WITH INTEGRATED RAPID SHUTDOWN \*REFLECTIVE\*

**PHOTOVOLTAIC POWER SOURCE**  
 OPERATING AC VOLTAGE 240 V  
 MAXIMUM OPERATING  
 AC OUTPUT CURRENT 42.0 A

NEC 690.54  
 PLACE ON INTERCONNECTION  
 DISCONNECTING MEANS

**DIRECT CURRENT  
 PHOTOVOLTAIC POWER SOURCE**  
 MAXIMUM VOLTAGE 600 VDC  
 MAX CIRCUIT CURRENT 30.0 AMPS

NEC 690.53  
 PLACE ON ALL DC DISCONNECTING MEANS

**SOLAR PV SYSTEM EQUIPPED  
 WITH RAPID SHUTDOWN**

TURN RAPID SHUTDOWN  
 SWITCH TO THE  
 "OFF" POSITION TO  
 SHUT DOWN PV SYSTEM  
 AND REDUCE  
 SHOCK HAZARD  
 IN THE ARRAY

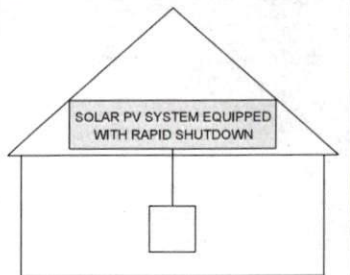

NEC 690.56 (C)(1)(a)  
 PLACE WITHIN 3FT OF SERVICE DISCONNECTING MEANS TO  
 WHICH THE PV SYSTEMS ARE CONNECTED AND SHALL  
 INDICATE THE LOCATIONS OF RAPID SHUTDOWN SWITCHES

**WARNING: PHOTOVOLTAIC  
 POWER SOURCE**

NEC 690.31 (G)(3)&(4)  
 PLACE ON ALL JUNCTION BOXES EXPOSED RACEWAYS  
 EVERY 10' AND 1' FROM BENDS AND PENETRATIONS,  
 ADJACENT TO THE MAIN SERVICE DISCONNECT \*REFLECTIVE\*

**PV SYSTEM  
 DISCONNECT**

NEC 690.13 (B)  
 PLACE ON PV SYSTEM DISCONNECTING MEANS.

*EQUIPMENT LABEL NOTES*

- LABELS SHOWN ARE THEIR ACTUAL REQUIRED SIZE.
- LABEL MATERIAL SHALL BE SUITABLE FOR THE EQUIPMENT ENVIRONMENT.
- CONDUIT SHALL BE MARKED WITH REQUIRED LABEL EVERY 10 FEET.

ENGINEER:

MODEL ENERGY  
 300 FAYETTEVILLE ST.  
 #1430  
 RALEIGH, NC 27602  
 919-274-9905  
 MODELENERGY.COM  
 P-1194

JOB TITLE:

NEW SOLAR PV SYSTEM  
 10.23 KW DC INPUT  
 10.00 KW AC EXPORT

RANDALL MADRIGAL  
 1802 NC 27 E  
 LILLINGTON NC 27546

CLIENT:

ISSUED FOR:	DATE:
CONSTRUCTION	07/15/19

EQUIPMENT LABELS

**PV4.1**

© 2019 MODEL ENERGY, PLLC EXPRESSLY RESERVES ITS COMMON LAW COPYRIGHT AND OTHER PROPERTY RIGHTS IN THESE PLANS. THESE PLANS ARE NOT TO BE REPRODUCED, CHANGED OR COPIED IN ANY FORM OR MANNER WHATSOEVER, NOR ARE THEY TO BE ASSIGNED TO ANY THIRD PARTY WITHOUT FIRST OBTAINING THE EXPRESSED WRITTEN PERMISSION AND CONSENT OF MODEL ENERGY, PLLC.

powered by  
**Q.ANTUM DUO**

# Q.PEAK DUO BLK-G5 305-320

## Q.ANTUM SOLAR MODULE

The new Q.PEAK DUO BLK-G5 solar module from Q CELLS impresses with its outstanding visual appearance and particularly high performance on a small surface thanks to the innovative Q.ANTUM DUO Technology. Q.ANTUM's world-record-holding cell concept has now been combined with state-of-the-art circuitry half cells and a six-busbar design, thus achieving outstanding performance under real conditions — both with low-intensity solar radiation as well as on hot, clear summer days.



**Q.ANTUM TECHNOLOGY: LOW LEVELISED COST OF ELECTRICITY**  
Higher yield per surface area, lower BOS costs, higher power classes, and an efficiency rate of up to 19.3%.



**INNOVATIVE ALL-WEATHER TECHNOLOGY**  
Optimal yields, whatever the weather with excellent low-light and temperature behaviour.



**ENDURING HIGH PERFORMANCE**  
Long-term yield security with Anti LID Technology, Anti PID Technology<sup>1</sup>, Hot-Spot Protect and Traceable Quality Tra.Q™.



**EXTREME WEATHER RATING**  
High-tech aluminium alloy frame, certified for high snow (5400 Pa) and wind loads (4000 Pa).



**A RELIABLE INVESTMENT**  
Inclusive 12-year product warranty and 25-year linear performance warranty<sup>2</sup>.



**STATE OF THE ART MODULE TECHNOLOGY**  
Q.ANTUM DUO combines cutting edge cell separation and innovative wiring with Q.ANTUM Technology.

### THE IDEAL SOLUTION FOR:



Rooftop arrays on residential buildings

Engineered in **Germany**



www.VDEInfo.com  
ID: 40032587

<sup>1</sup> APT test conditions according to IEC/TS 62804-1:2015, method B (-1500V, 168 h)

<sup>2</sup> See data sheet on rear for further information.

# Q CELLS

## MECHANICAL SPECIFICATION

Format	1685 mm × 1000 mm × 32 mm (including frame)
Weight	18.7 kg
Front Cover	3.2 mm thermally pre-stressed glass with anti-reflection technology
Back Cover	Composite film
Frame	Black anodised aluminium
Cell	6 × 20 monocrystalline Q.ANTUM solar half cells
Junction box	70-85 mm × 50-70 mm × 13-21 mm Protection class IP67, with bypass diodes
Cable	4 mm <sup>2</sup> Solar cable; (+) 1100 mm, (-) 1100 mm
Connector	Multi-Contact MC4, IP65 and IP68

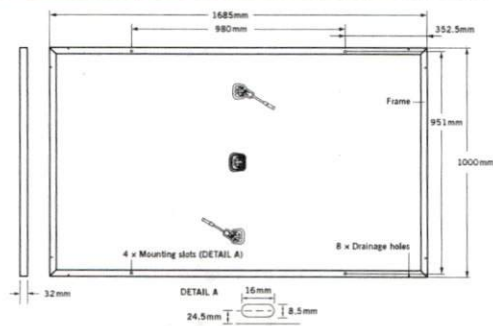

## ELECTRICAL CHARACTERISTICS

POWER CLASS		305	310	315	320	
MINIMUM PERFORMANCE AT STANDARD TEST CONDITIONS, STC <sup>1</sup> (POWER TOLERANCE +5W / -0W)						
Minimum	Power at MPP <sup>2</sup>	$P_{MPP}$ [W]	305	310	315	320
	Short Circuit Current <sup>*</sup>	$I_{SC}$ [A]	9.78	9.83	9.89	9.94
	Open Circuit Voltage <sup>*</sup>	$V_{OC}$ [V]	39.75	40.02	40.29	40.56
	Current at MPP <sup>*</sup>	$I_{MPP}$ [A]	9.31	9.36	9.41	9.47
	Voltage at MPP <sup>*</sup>	$V_{MPP}$ [V]	32.78	33.12	33.46	33.80
	Efficiency <sup>2</sup>	$\eta$ [%]	≥ 18.1	≥ 18.4	≥ 18.7	≥ 19.0
MINIMUM PERFORMANCE AT NORMAL OPERATING CONDITIONS, NOC <sup>3</sup>						
Minimum	Power at MPP <sup>2</sup>	$P_{MPP}$ [W]	226.0	229.7	233.5	237.2
	Short Circuit Current <sup>*</sup>	$I_{SC}$ [A]	7.88	7.93	7.97	8.02
	Open Circuit Voltage <sup>*</sup>	$V_{OC}$ [V]	37.18	37.43	37.69	37.94
	Current at MPP <sup>*</sup>	$I_{MPP}$ [A]	7.32	7.36	7.41	7.45
	Voltage at MPP <sup>*</sup>	$V_{MPP}$ [V]	30.88	31.20	31.52	31.84

<sup>1</sup>1000 W/m<sup>2</sup>, 25°C, spectrum AM 1.5G    <sup>2</sup>Measurement tolerances STC ± 3%; NOC ± 5%    <sup>3</sup>800 W/m<sup>2</sup>, NOCT, spectrum AM 1.5G    \* typical values, actual values may differ

### Q CELLS PERFORMANCE WARRANTY

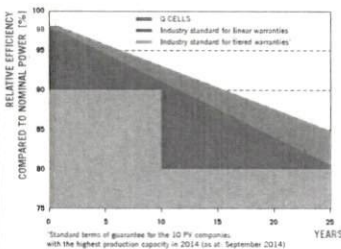

At least 98% of nominal power during first year. Thereafter max. 0.54% degradation per year. At least 93.1% of nominal power up to 10 years. At least 85% of nominal power up to 25 years.

All data within measurement tolerances. Full warranties in accordance with the warranty terms of the Q CELLS sales organisation of your respective country.

### PERFORMANCE AT LOW IRRADIANCE

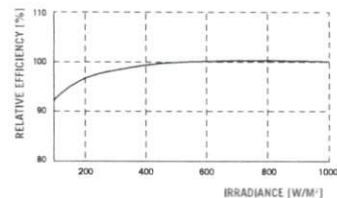

Typical module performance under low irradiance conditions in comparison to STC conditions (25°C, 1000 W/m<sup>2</sup>).

### TEMPERATURE COEFFICIENTS

Temperature Coefficient of $I_{SC}$	$\alpha$ [%/K]	+0.04	Temperature Coefficient of $V_{OC}$	$\beta$ [%/K]	-0.28
Temperature Coefficient of $P_{MPP}$	$\gamma$ [%/K]	-0.37	Normal Operating Cell Temperature	NOCT [°C]	45

## PROPERTIES FOR SYSTEM DESIGN

Maximum System Voltage	$V_{SYS}$ [V]	1000	Safety Class	II
Maximum Reverse Current	$I_R$ [A]	20	Fire Rating	C
Push/Pull Load (Test-load in accordance with IEC 61215)	[Pa]	5400/4000	Permitted Module Temperature On Continuous Duty	-40°C up to +85°C

## QUALIFICATIONS AND CERTIFICATES

VDE Quality Tested, IEC 61215 (Ed.2); IEC 61730 (Ed.1), Application class A  
This data sheet complies with DIN EN 50380.



## PARTNER

**NOTE:** Installation instructions must be followed. See the installation and operating manual or contact our technical service department for further information on approved installation and use of this product.

Hanwha Q CELLS GmbH

Sonnenallee 17-21, 06766 Bitterfeld-Wolfen, Germany | TEL +49 (0)3494 66 99-23444 | FAX +49 (0)3494 66 99-23000 | EMAIL sales@q-cells.com | WEB www.q-cells.com

Specifications subject to technical changes © Hanwha Q CELLS Q.PEAK DUO BLK-G5\_305-320\_2017-07\_Rev01\_EN

Engineered in Germany

**Q CELLS**

# Single Phase Inverter with HD-Wave Technology

for North America

SE3000H-US / SE3800H-US / SE5000H-US / SE6000H-US /  
SE7600H-US / SE10000H-US / SE11400H-US

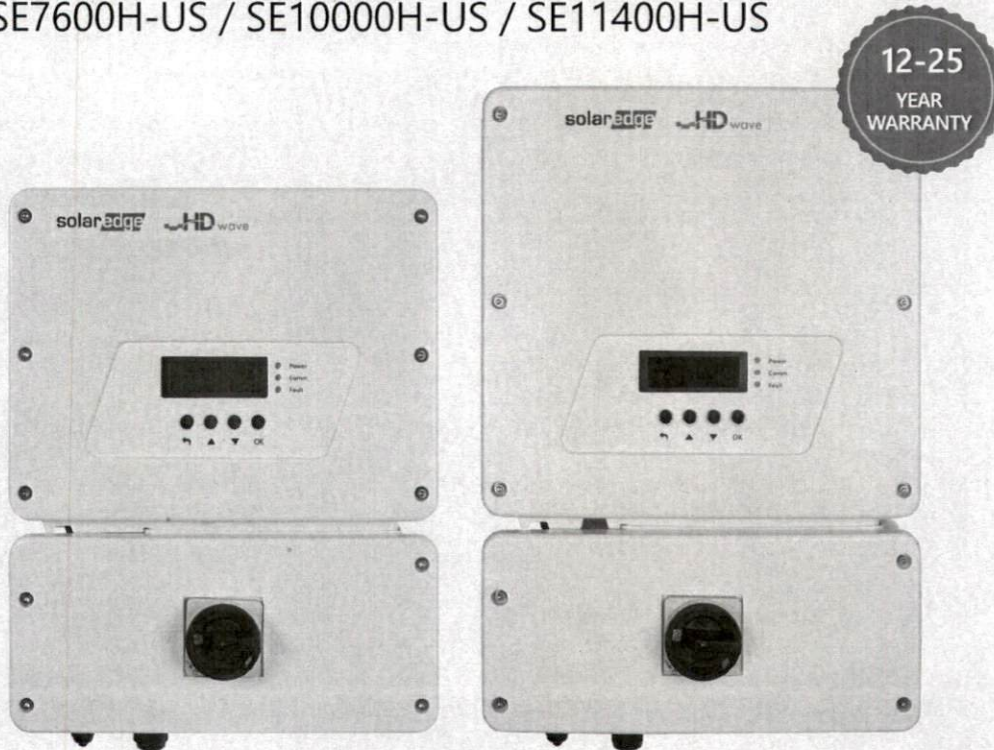

# INVERTERS

## Optimized installation with HD-Wave technology

- Specifically designed to work with power optimizers
- Record-breaking efficiency
- Fixed voltage inverter for longer strings
- Integrated arc fault protection and rapid shutdown for NEC 2014 and 2017, per article 690.11 and 690.12
- UL1741 SA certified, for CPUC Rule 21 grid compliance
- Extremely small
- Built-in module-level monitoring
- Outdoor and indoor installation
- Optional: Revenue grade data, ANSI C12.20 Class 0.5 (0.5% accuracy)



# / Single Phase Inverter with HD-Wave Technology for North America

SE3000H-US / SE3800H-US / SE5000H-US / SE6000H-US /  
SE7600H-US / SE10000H-US / SE11400H-US

SE3000H-US SE3800H-US SE5000H-US SE6000H-US SE7600H-US SE10000H-US SE11400H-US

## OUTPUT

Rated AC Power Output	3000	3800 @ 240V 3300 @ 208V	5000	6000 @ 240V 5000 @ 208V	7600	10000	11400 @ 240V 10000 @ 208V	VA
Maximum AC Power Output	3000	3800 @ 240V 3300 @ 208V	5000	6000 @ 240V 5000 @ 208V	7600	10000	11400 @ 240V 10000 @ 208V	VA
AC Output Voltage Min.-Nom.-Max. (211 - 240 - 264)	✓	✓	✓	✓	✓	✓	✓	Vac
AC Output Voltage Min.-Nom.-Max. (183 - 208 - 229)	-	✓	-	✓	-	-	✓	Vac
AC Frequency (Nominal)	59.3 - 60 - 60.5 <sup>(1)</sup>							Hz
Maximum Continuous Output Current @240V	12.5	16	21	25	32	42	47.5	A
Maximum Continuous Output Current @208V	-	16	-	24	-	-	48.5	A
GFDI Threshold	1							A
Utility Monitoring, Islanding Protection, Country Configurable Thresholds	Yes							

## INPUT

Maximum DC Power @240V	4650	5900	7750	9300	11800	15500	17650	W
Maximum DC Power @208V	-	5100	-	7750	-	-	15500	W
Transformer-less, Ungrounded	Yes							
Maximum Input Voltage	480							Vdc
Nominal DC Input Voltage	380			400				Vdc
Maximum Input Current @240V <sup>(2)</sup>	8.5	10.5	13.5	16.5	20	27	30.5	Adc
Maximum Input Current @208V <sup>(2)</sup>	-	9	-	13.5	-	-	27	Adc
Max. Input Short Circuit Current	45							Adc
Reverse-Polarity Protection	Yes							
Ground-Fault Isolation Detection	600k $\Omega$ Sensitivity							
Maximum Inverter Efficiency	99	99.2						%
CEC Weighted Efficiency	99						99 @ 240V 98.5 @ 208V	%
Nighttime Power Consumption	< 2.5							W

## ADDITIONAL FEATURES

Supported Communication Interfaces	RS485, Ethernet, ZigBee (optional), Cellular (optional)
Revenue Grade Data, ANSI C12.20	Optional <sup>(3)</sup>
Rapid Shutdown - NEC 2014 and 2017 690.12	Automatic Rapid Shutdown upon AC Grid Disconnect

## STANDARD COMPLIANCE

Safety	UL1741, UL1741 SA, UL1699B, CSA C22.2, Canadian AFCI according to T.I.L. M-07
Grid Connection Standards	IEEE1547, Rule 21, Rule 14 (HI)
Emissions	FCC Part 15 Class B

## INSTALLATION SPECIFICATIONS

AC Output Conduit Size / AWG Range	3/4" minimum / 14-6 AWG		3/4" minimum / 14-4 AWG			
DC Input Conduit Size / # of Strings / AWG Range	3/4" minimum / 1-2 strings / 14-6 AWG		3/4" minimum / 1-3 strings / 14-6 AWG			
Dimensions with Safety Switch (HxWxD)	17.7 x 14.6 x 6.8 / 450 x 370 x 174		21.3 x 14.6 x 7.3 / 540 x 370 x 185		in / mm	
Weight with Safety Switch	22 / 10	25.1 / 11.4	26.2 / 11.9	38.8 / 17.6	lb / kg	
Noise	< 25		< 50		dBa	
Cooling	Natural Convection					
Operating Temperature Range	-40 to +140 / -25 to +60 <sup>(4)</sup> (-40°F / -40°C option) <sup>(5)</sup>					°F / °C
Protection Rating	NEMA 4X (Inverter with Safety Switch)					

<sup>(1)</sup> For other regional settings please contact SolarEdge support

<sup>(2)</sup> A higher current source may be used, the inverter will limit its input current to the values stated

<sup>(3)</sup> Revenue grade inverter P/N: SExxxxH-US000NNC2

<sup>(4)</sup> For power de-rating information refer to: <https://www.solaredge.com/sites/default/files/se-temperature-derating-note-na.pdf>

<sup>(5)</sup> -40 version P/N: SExxxxH-US000NNU4

## WEEB-LUG

The WEEB-Lug consists of a WEEB washer, lay-in lug, and hardware. It is used with one solid or stranded copper wire (14AWG to 6AWG), or two copper wires (12AWG to 10AWG) to provide a continuous ground on roof or ground mounted solar systems. Unlike traditional lay-in lugs, the WEEB-Lug does not require surface preparation on rail or module to install. The WEEB Lug is installed using stainless steel mounting hardware. When the hardware is tightened the WEEB's specialized teeth embed into anodized aluminum, galvanized steel, or any electrically conductive metal to establish a gas tight electrical connection. The tin-plated Lug assures minimum contact resistance and protection against corrosion. Copper wire is clamped by a 1/4-28 stainless steel screw, which is horizontal to the tang for easy access when mounted under a PV module. The low profile of the WEEB Lug allows it to be installed in a variety of positions.

Catalog	Item #	L x W x H	Hole	Hardware	Torque
WEEB-LUG-6.7	30020109	1.60" x 0.71" x 0.47"	0.266"	1/4 inch hardware - included unassembled	7 ft. lbs. for terminal screw
WEEB-LUG-6.7AS	30020110	1.60" x 0.71" x 0.47"		1/4 inch hardware - included assembled	
WEEB-LUG-8.0	30020111	1.60" x 0.87" x 0.47"	0.323"	M8 or 5/16 inch hardware - not included	10 ft. lbs. for mounting hardware w/ Penetrox-A on threads
WEEB-LUG-8.0AS	50010335	1.60" x 0.87" x 0.47"		5/16 inch hardware - included assembled	
WEEB-LUG-8.2MS	30020115	1.60" x 0.71" x 0.47"		M8 or 5/16 inch hardware - not included	
WEEB-LUG-15.8	30020112	1.60" x 0.71" x 0.47"		M8 or 5/16 inch hardware - not included	

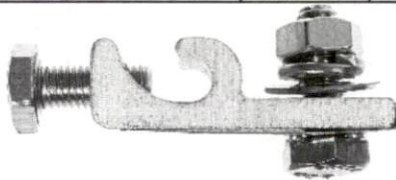

- Material: 304 stainless steel, tin-plated copper, outdoor rated
- Low profile design
- Multiple equipment ground conductor allowance:  
One 14 AWG to 6 AWG or two 10 AWG, two 12 AWG
- Listed to ANSI/UL 467 by Intertek ETL

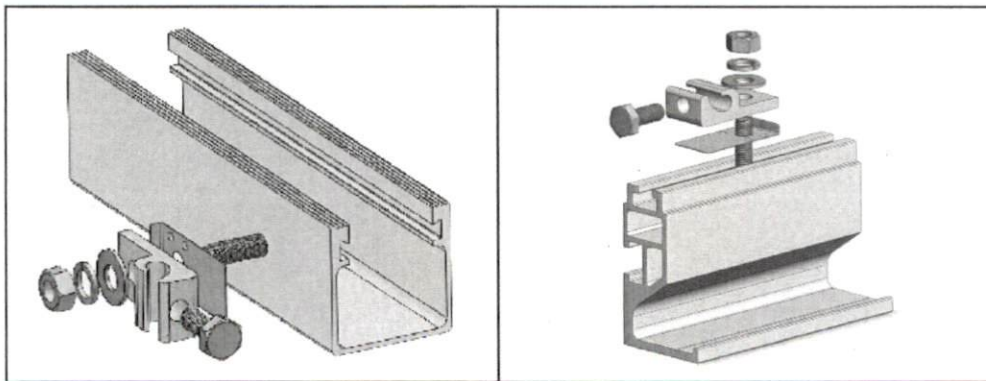

**Customer Service Department**  
7 Aviation Park Drive  
Londonderry NH 03053  
1-800-346-4175  
1-603-647-5299 (International)



Intertek  
4004188

