

Additional parts and accessories are available for purchase online at:
www.SevilleClassics.com



Shelf Labels
8-Pack
Model No.: WEB106



Shelf Liners
30" x 14" (5-Pack)
Model No.: WEB750



Steel Wire Shelf
30" x 14"
Model No.: WEB370



View assembly online here:
<https://www.youtube.com/watch?v=N6iRVVqBG-I>

Caution

- Place heavier items on the lower shelves and lighter ones on the top.
- Do not stand or climb on the shelving system.
- Do not drop heavy items on the system.
- Do not move the system while loaded.

Specifications

Assembled Dimensions: 30" W x 14" D x 48" H (49.5" H on casters)

Weight capacity	Per shelf	Overall
On leveling feet	300 lbs. (136 kg)	1200 lbs. (544.3 kg)
On casters	27.5 lbs. (12.4 kg)	110 lbs. (49.9 kg)

Customer Service Information

Seville Classics, Inc

Telephone: (800) 323-5565

Fax: (310) 533-3899

Hours: 8:30 AM – 4:30 PM (PST), Monday to Friday

Email: Support@SevilleClassics.com

Homepage: www.SevilleClassics.com

07102023

seville classics®

4-Tier Steel Wire Shelving with Caster 30"W x 14"D x 49.5"H (48"H on leveling feet)

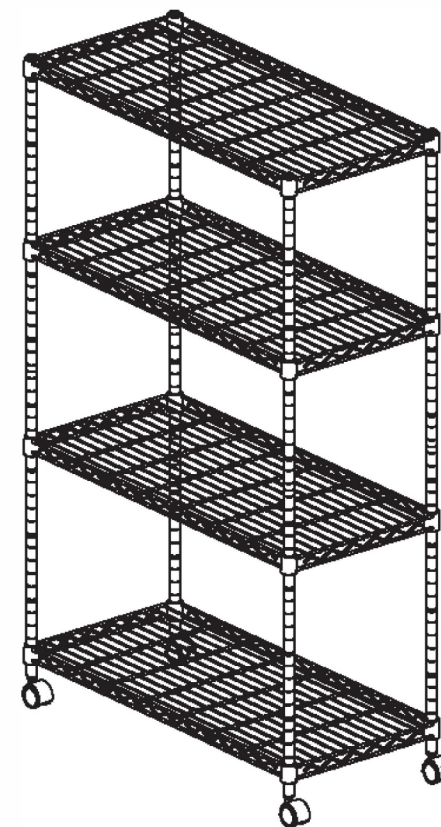









Model #: WEB674

Thank you for choosing Seville Classics! We hope that you enjoy your steel wire shelving system! Please read through this guide for parts list, assembly instructions, frequently asked questions and further contact information.

07102023

Parts List

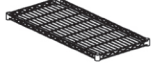
Please make sure you have all the parts on this list.

A. Bottom poles (4) (Threaded end)		E. Slip sleeves (16)	
B. Top poles (4) (Plastic cap on end)		F. Leveling feet (4)	
C. Connectors (4) (May be attached to poles)		G. Casters (2)	
D. Shelves (4)		H. Locking Casters (2)	

If you're missing parts, contact us for replacements at (800) 323-5565 or send an email to Support@SevilleClassics.com

Assembly Instructions

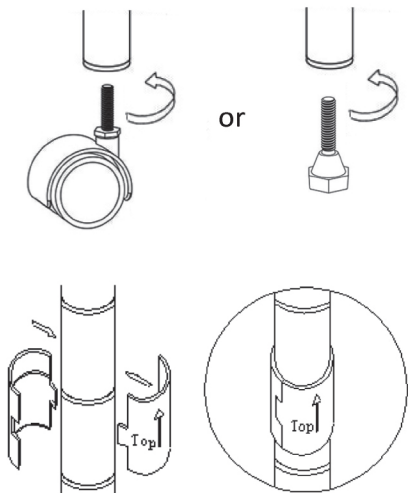

1

STEP 1.

Screw **LEVELING FEET (F)** or **CASTERS (G, H)** into base of bottom poles.

Repeat for all bottom poles.

STEP 2.

Snap **SLIP SLEEVES (E)** around the grooves on **BOTTOM POLES (A)** for your lowest shelf.

TIP! Count the number of grooves from the bottom of the pole to keep the height consistent.

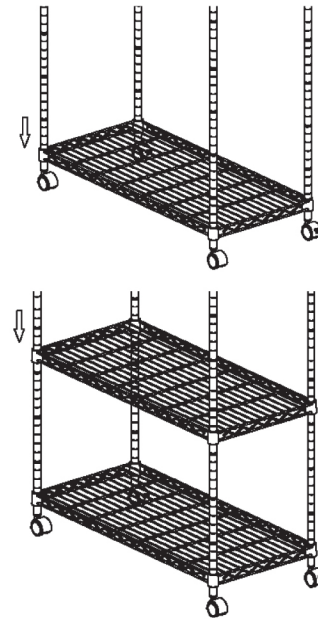

STEP 3.

Fit **SHELF (D)** over the top of the 4 poles and over **SLIP SLEEVES (E)**.

Repeat **STEPS 2-3** for next shelf.

TIP! If necessary, lightly tap shelves into place with a rubber mallet.

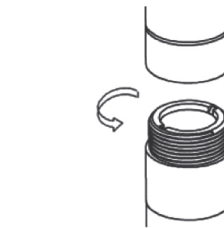

STEP 4.

Screw **CONNECTORS (C)** into top of **BOTTOM POLES (A)**.

Screw **TOP POLES (B)** to **CONNECTORS (C)**.

TIP! Connectors may be pre-installed.

STEP 5.

Repeat **STEPS 2-3** for remaining shelves.

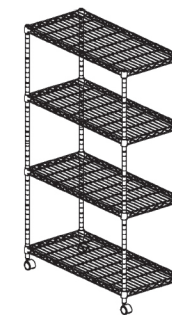
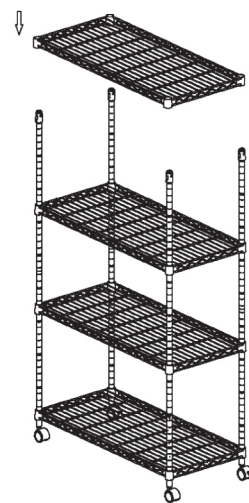

Congratulations!

Enjoy your now complete shelving unit.

2