

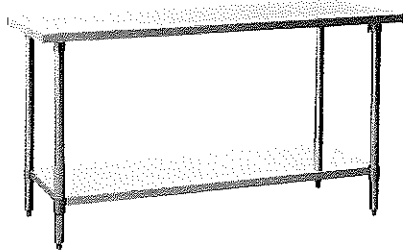



# Roughneck Stainless Steel Work Table — 1000-Lb. Capacity, 72in.W x 24in.D x 35in.H

 Item# 42376 ★★★★★ (15) [Write a Review](#) [Ask a Question](#)

**Only \$289.99**
 **PayPal** Pay in 4 interest-free payments of \$72.50. [Learn more](#)
 **Ship It**  
In Stock

 **Store Pickup in Under 2hrs (In-Store or Curbside)**  
[See Pickup Details](#)

- Adjustable feet adapt to uneven surfaces
- Galvanized shelf provides storage and keeps tools and work materials within easy reach
- 1,000lb. capacity
- Durable 18-ga. stainless steel top
- 4 sturdy galvanized legs

## Product Summary

Add additional work space in your garage, shop, basement or just about anywhere with this commercial-grade Roughneck® stainless steel work table with shelf. The stainless steel top provides an easy-to-clean, straight-edge work surface. **Oversize shipping charge applies.**

### What's Included

(1) Stainless steel work table

## Features + Benefits

- Adjustable feet adapt to uneven surfaces
- Galvanized shelf provides storage and keeps tools and work materials within easy reach
- 1,000lb. capacity
- Durable 18-ga. stainless steel top
- 4 sturdy galvanized legs
- 72in.W x 24in.D x 35in.H overall size

## Key Specs

Item#	42376	Height	35
Brand	<a href="#">Roughneck</a>	Dimensions W x D x H (in.)	24 x 72 x 35
Manufacturer's Warranty	1 year Limited Warranty	Capacity (lbs.)	1,000
Ship Weight	79.0 lbs	Material	Stainless steel
Width	72	Portable or Stationary	Stationary
Depth	24		

## Compare with Most Popular Workbenches + Work Tables

### Currently Viewing

Item# 42376

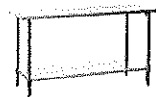

Roughneck Stainless Steel Work Table — 1000-Lb. Capacity, 72in.W x 24in.D x 35in.H

★★★★★ (15)

**Only \$289.99**

Item# 42375

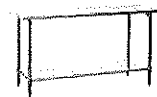

Roughneck Stainless Steel Work Table — 48in.W x 24in.D x 35in.H

★★★★★ (5)

**Only \$244.99**

Item# 60388



Keter Folding Work Table with Two Adjustable Clamps — 1000-Lb. Capacity, Model# 252638

★★★★★ (1583)

**Only \$129.99**

Item# 252204



2x4 Basics AnySize Workbench Kit with Shelf/Links — Model# 90164M

★★★★★ (258)

**Only \$109.99**

Item# 179065

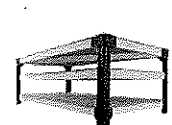

2x4 Basics AnySize Workbench Kit — Model# 90158M

★★★★★ (1)

**Only \$84.99**

Width	72	48	33 1/2in.	-	-
Depth	24	24	21 3/4in.	-	-

Height	35	35	29 3/4	-	-
Dimensions W x D x H (in.)	24 x 72 x 35	48 x 24 x 35	33 1/2 x 21 3/4 x 29 3/4	-	-
Capacity	-	-	-	1,000 lb	-
Capacity (lbs.)	1,000	1,000	1,000	-	-
Material	Stainless steel	Stainless steel	Resin, aluminum	Resin	Resin
Drawers (qty.)	-	-	-	0	-
Portable	-	-	-	No	-
Portable or Stationary	Stationary	Stationary	Stationary	Stationary	Stationary
Vises Included	-	-	-	No	-



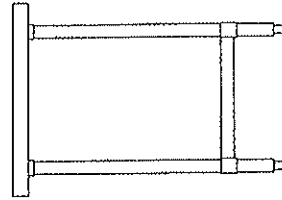
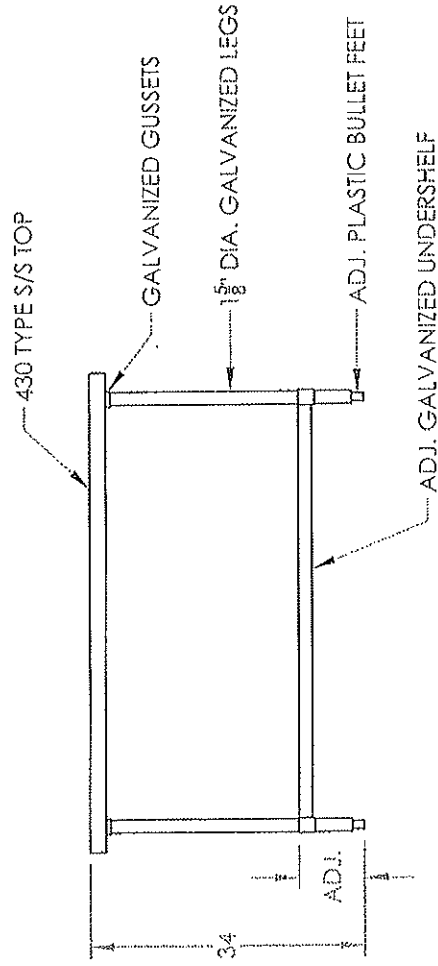
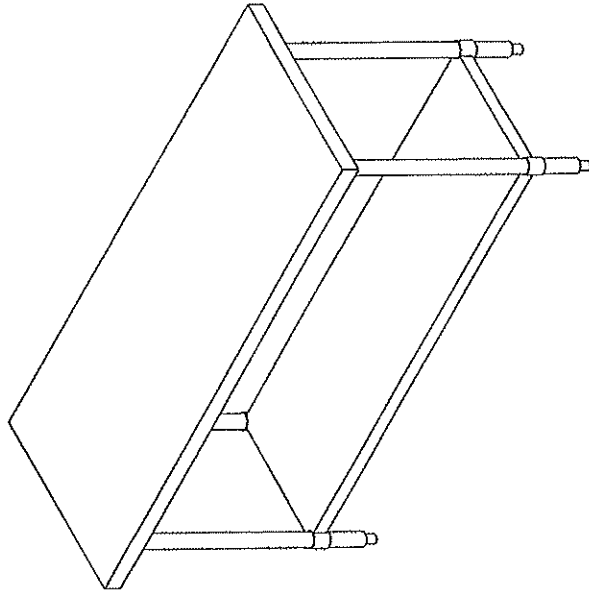
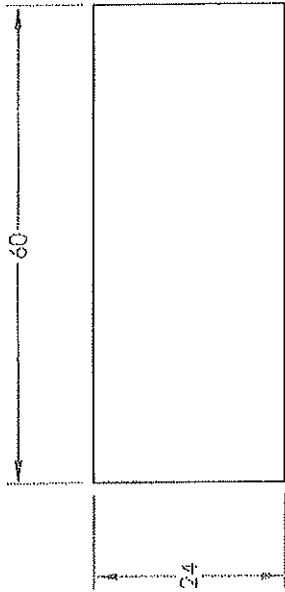

By signing this document an agreement has been made to begin fabrication of above shown equipment that cannot be reversed. A contract with Aero Mfg. Co. is agreed and equipment is non-cancellable nor returnable.

APPROVED  
 APPROVED AS NOTED  
 RESUBMIT AS NOTED

SIGNATURE: \_\_\_\_\_ DATE: \_\_\_\_\_



**PROPRIETARY AND CONFIDENTIAL**  
 The information contained in this drawing is the sole property of Aero Mfg. Co. Any reproduction in part or as a whole is prohibited.

**UNLESS OTHERWISE SPECIFIED:**  
 Tolerances  
 Fractional:  $\pm 1/4$   
 Decimal:  $\pm 0.25$   
 Angular:  $\pm 1^\circ$

DRAWN:	D.S.	NAME	DATE
CHECKED:			04.28.10
MODEL NO.:	AI-2460	CUSTOMER:	
ITEM NO.:		SHEET SIZE: A	DWG. NO.
QUANTITY:		SCALE: 1/2" = 1'-0"	SHEET: 1 OF 1

**AERO MANUFACTURING CO.**  
 CLIFTON, NJ 07012  
 PHONE: 800.237.6634 FAX: 973.473.3794  
 WEBSITE: AEROMFG.COM

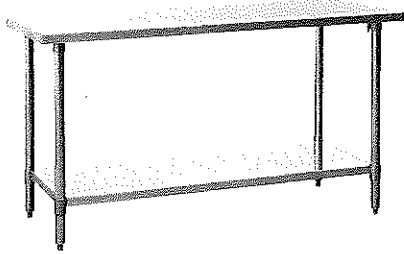
# Roughneck Stainless Steel Work Table — 48in.W x 24in.D x 35in.H

 Item# 42375 ★★★★★ (5) [Write a Review](#) [Ask a Question](#)

**Only \$244.99**
 **PayPal** Pay in 4 interest-free payments of \$61.25. [Learn more](#)

**Ship It**

Backordered Online — will ship in 30 or more Business Days. Due to high demand, additional delays in shipment may occur.

- Adjustable feet adapt to uneven surfaces
- Galvanized shelf provides storage and keeps tools and work materials within easy reach
- 1,000lb. capacity
- Durable 18-ga. stainless steel top
- 4 sturdy galvanized legs

## Product Summary

Add additional work space in your garage, shop, basement or just about anywhere with this commercial-grade Roughneck stainless steel work table with shelf. The stainless steel top provides an easy-to-clean, straight-edge work surface.

**What's Included**

(1) Stainless steel work table

## Features + Benefits

- Adjustable feet adapt to uneven surfaces
- Galvanized shelf provides storage and keeps tools and work materials within easy reach
- 1,000lb. capacity
- Durable 18-ga. stainless steel top
- 4 sturdy galvanized legs
- 48in.W x 24in.D x 35in.H overall size

## Key Specs

Item#	42375	Height	35
Brand	<u>Roughneck</u>	Dimensions W x D x H (in.)	48 x 24 x 35
Manufacturer's Warranty	1 year Limited Warranty	Capacity (lbs.)	1,000
Ship Weight	58.0 lbs	Material	Stainless steel
Width	48	Portable or Stationary	Stationary
Depth	24		

## Compare with Most Popular Workbenches + Work Tables

	Item# 42376	Currently Viewing Item# 42375	Item# 60388	Item# 252204	Item# 179065
					
	<a href="#">Roughneck Stainless Steel Work Table — 1000-Lb. Capacity, 72in.W x 24in.D x 35in.H</a>	<a href="#">Roughneck Stainless Steel Work Table — 48in.W x 24in.D x 35in.H</a>	<a href="#">Keter Folding Work Table with Two Adjustable Clamps — 1000-Lb. Capacity, Model# 252638</a>	<a href="#">2x4 Basics AnySize Workbench Kit with ShellLinks — Model# 90164M</a>	<a href="#">2x4 Basics AnySize Workbench Kit — Model# 90158M</a>
	★★★★★ (15)	★★★★★ (5)	★★★★★ (1583)	★★★★★ (258)	★★★★★ (1) 
	<b>Only \$289.99</b>	<b>Only \$244.99</b>	<b>Only \$129.99</b>	<b>Only \$109.99</b>	<b>Only \$84.99</b>
Width	72	48	33 1/2in.	-	-
Depth	24	24	21 3/4in.	-	-

<b>Height</b>	35	35	29 3/4	-	-
<b>Dimensions W x D x H (in.)</b>	24 x 72 x 35	48 x 24 x 35	33 1/2 x 21 3/4 x 29 3/4	-	-
<b>Capacity</b>	-	-	-	1,000 lb	-
<b>Capacity (lbs.)</b>	1,000	1,000	1,000	-	-
<b>Material</b>	Stainless steel	Stainless steel	Resin, aluminum	Resin	Resin
<b>Drawers (qty.)</b>	-	-	-	0	-
<b>Portable</b>	-	-	-	No	-
<b>Portable or Stationary</b>	Stationary	Stationary	Stationary	Stationary	Stationary
<b>Vises Included</b>	-	-	-	No	-



- KDT-1000A       KDT-1000W       KDT-1000N
- KYT-1000A       KYT-1000W       KYT-1000N



# KT-1000 Ice Kube Machine



- Easy access to food zone with removal of two screws and lift-off door
- High-tech exterior with smudge and fingerprint resistant stainless-like finish
- White plastics in the food zone help identify areas needing cleaning
- Water shield, distribution tube, pump, floats, and trough removable by hand
- Available CleanAir™ pack controls the growth of bacteria and fungi that form slime and cause odors in the food zone

**WARRANTY:**  
 Ice Maker: 3 year Parts & Labor  
 Evaporator: 5 year Parts & Labor  
 Compressor: 5 year Parts & 3 year Labor



**HALF KUBE**  
 $\frac{3}{8}'' \times 1\frac{1}{4}'' \times \frac{7}{8}''$   
 (.95 x 2.86 x 2.22 cm)  
 ❄️ = 100%



**KUBE**  
 $\frac{7}{8}'' \times \frac{7}{8}'' \times \frac{7}{8}''$   
 (2.22 x 2.22 x 2.22 cm)  
 ❄️ = 100%

Refrigerant R410A

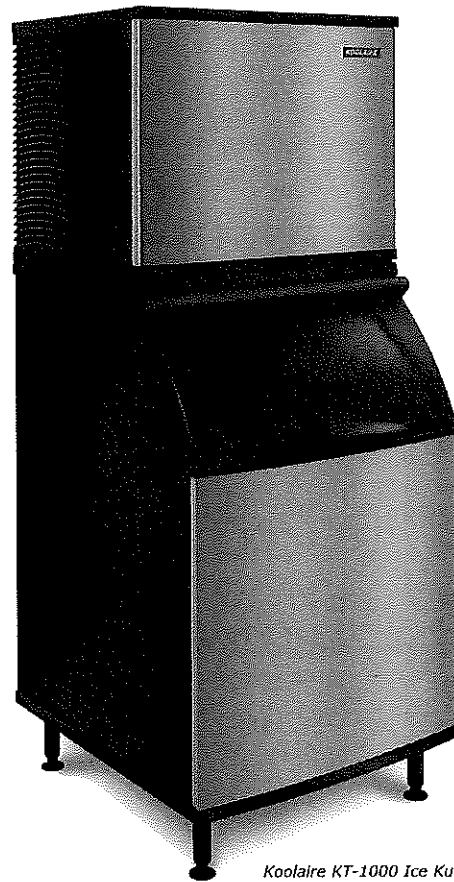

**KT-1000**  
ICE KUBE MACHINE

*Koolaire KT-1000 Ice Kube Machine on a K570 bin.*

*Both ice machine and bin are AHRI certified.*

**KOOLAIRE**

By MANITOWOC



2110 SOUTH 26TH ST | MANITOWOC, WI 54220 USA | 1-920-682-0161 [ [www.kool-air.com](http://www.kool-air.com) ]



# KT-1000 ICE KUBE MACHINE

Icon	Icon	Icon	24h		Icon	Icon
			70°/50°F 21°/10°C	90°/70°F 32°/21°C		
KDT-1000A			890 lbs 404 kg	680 lbs 308 kg	5.35	20.0
KYT-1000A			960 lbs 435 kg	775 lbs 362 kg		
KDT-1000W			835 lbs 379 kg	720 lbs 327 kg	4.35	20.0
KYT-1000W			860 lbs 390 kg	730 lbs 331 kg		
KDT-1000N*			850 lbs 386 kg	700 lbs 318 kg	5.3	20.0
KYT-1000N*			930 lbs 422 kg	760 lbs 345 kg		

\* Remote condenser JCT1200 must be ordered with "N" models

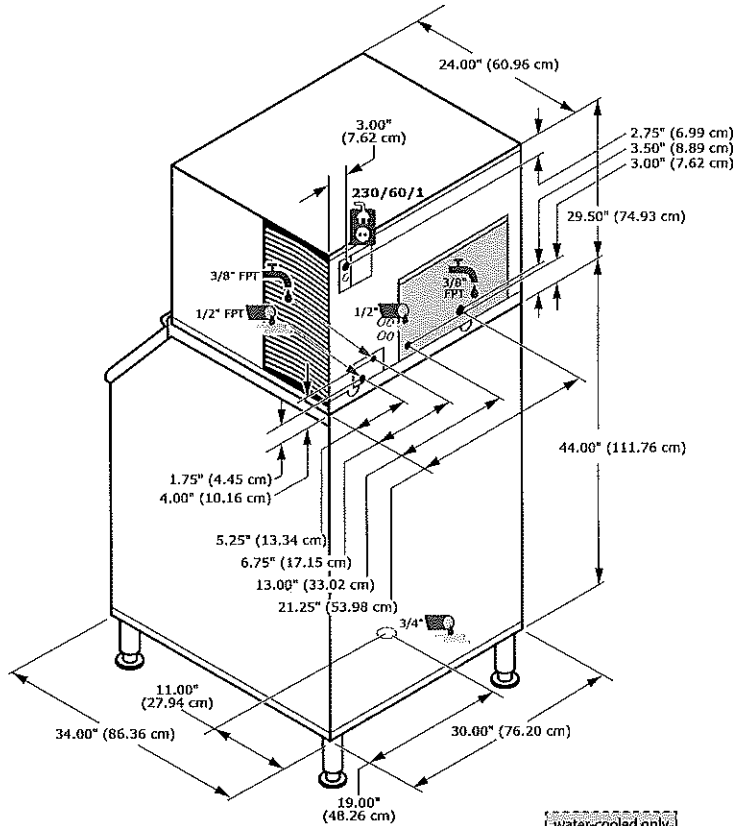

Minimum	Maximum
40°F 4.4°C	110°F 43.3°C
40°F 4.4°C	90°F 32.2°C
20psi 138 kPa	80psi 551 kPa
10.8 10.1 9.8	A
	15 Amps
215 lbs 215 lbs 237 lbs	97 kg 97 kg 108 kg

Water cooled condenser water usage/ 100lbs or 45.4kgs. of ice: 140 gals/530 L.

Popular Accessories			
Artic Pure Water Filters	Dispenser Bin Thermostat Kit	Top Air Discharge Kit	Clean Air Pack
AR-Pre & AR 20000	K-00457	K-00449	K-00206

## KOOLAIRE

By MANITOWOC

2110 SOUTH 26TH ST | MANITOWOC, WI 54220 USA | 1-920-682-0161 [ [www.kool-air.com](http://www.kool-air.com) ]

# DIMENSIONS and SPECIFICATIONS

TOL Overall:  $\pm .500''$   
 Interior:  $\pm .250''$

ALL DIMENSIONS ARE TYPICAL

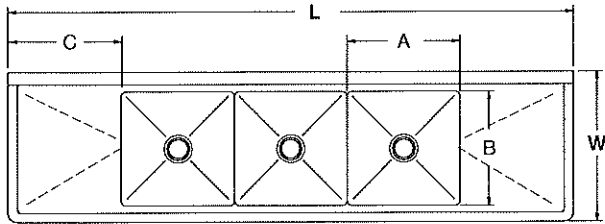

**3 COMP - 2 DRBD**

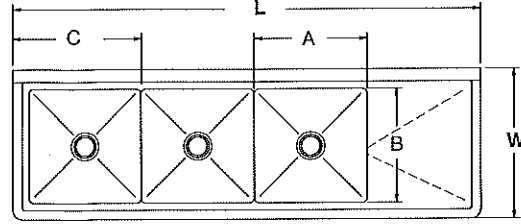

**3 COMP - 1 DRBD**

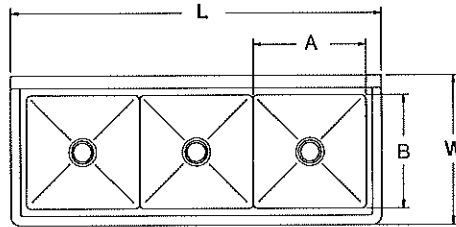

**3 COMP**

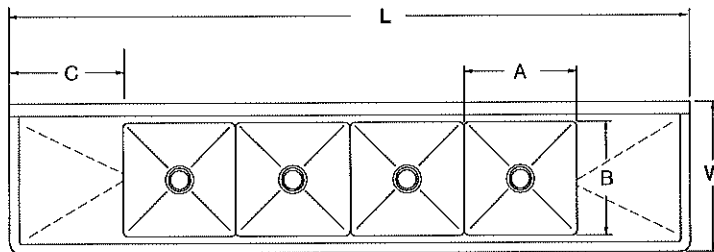

**4 COMP - 2 DRBD**

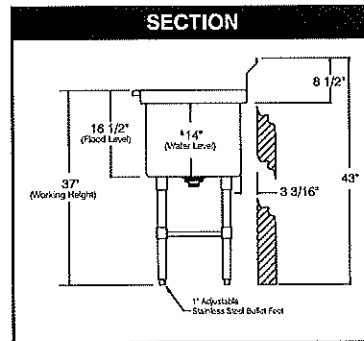
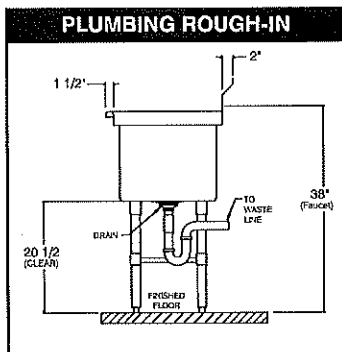

**ACCESSORIES**

	Model #	Qty
DRAINS		
FAUCETS		

**OPTIONAL MODIFICATIONS:**

K-450	Extend Drainboard Length <i>(Drainboards over 36" Are Not Creased or Pitched.)</i>
K-470	Modify Bowl Depth

**See our full line of  
 Modifications & Accessories on the web!**







STAINLESS STEEL



# FABRICATED ECONOMY SINKS

## Three & Four Compartments

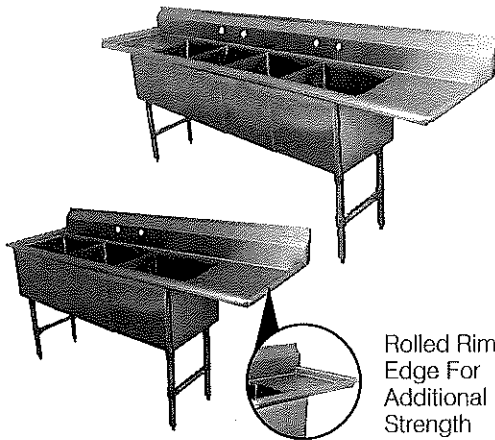

Fabricated Bowls are Welded Together at the Seams

Item #: \_\_\_\_\_ Qty #: \_\_\_\_\_

Model #: \_\_\_\_\_

Project #: \_\_\_\_\_

Rolled Rim Edge For Additional Strength

### FEATURES:

Backsplash has tile edge for ease of installation.

Sink bowls are 3/4" coved corner and meet NSF requirements.

Rolled Rim Edge for additional strength.

Sink Bowls are 14" deep for greater capacity.

Adjustable front-to-back cross-bracing

### MATERIAL:

1 5/8" diameter stainless steel legs with 1" adjustable stainless steel bullet feet.

Entire unit is 16 gauge 304 stainless steel.

Gussets - stainless steel.

### MECHANICAL:

- Supply is 1/2" IPS hot & cold.
- Faucet holes on 8" centers.
- Faucets are not included (see accessories).
- Waste drains are 1 1/2" IPS S/S basket type, located in center of sink bowl, and are included.

### CONSTRUCTION:

All TIG welded.

Welded areas blended to match adjacent surfaces and to a satin finish.

Gussets welded to a die-formed reinforced plate.

### OPTIONAL:



#### K-700

Removable Side Splashes Fits Left OR Right Side

MODEL #	Length L	Width W	Bowl Size A & B	Drbd. Length C	# Of Drbds.	Drbd. Location	Wt
FC-3-1515	50"	21"	15" x 15"	N/A	0	None	85 lbs.
FC-3-1515-15RorL	62.5"			15"	1	Specify	98 lbs.
FC-3-1515-15RL	75"			15"	2	R & L	120 lbs.
FC-3-1524	50"	30"	15" x 24"	N/A	0	None	180 lbs.
FC-3-1524-24RorL	71.5"			24"	1	Specify	210 lbs.
FC-3-1524-24RL	93"			24"	2	R & L	255 lbs.
FC-3-1620	53"	26"	16" x 20"	N/A	0	None	120 lbs.
FC-3-1620-18RorL	68.5"			18"	1	Specify	225 lbs.
FC-3-1620-18RL	84"			18"	2	R & L	235 lbs.
FC-3-1620-24RL	96"			24"	2	R & L	263 lbs.
FC-3-1620-36RL	120"			36"	2	R & L	300 lbs.
FC-3-1818	59"	24"	18" x 18"	N/A	0	None	135 lbs.
FC-3-1818-18RorL	74.5"			18"	1	Specify	235 lbs.
FC-3-1818-24RorL	80.5"			24"	1	Specify	250 lbs.
FC-3-1818-18RL	90"			18"	2	R & L	245 lbs.
FC-3-1818-24RL	102"			24"	2	R & L	265 lbs.
FC-3-1824	59"	30"	18" x 24"	N/A	0	None	182 lbs.
FC-3-1824-18RorL	74.5"			18"	1	Specify	220 lbs.
FC-3-1824-24RorL	80.5"			24"	1	Specify	230 lbs.
FC-3-1824-18RL	90"			18"	2	R & L	265 lbs.
FC-3-1824-24RL	102"			24"	2	R & L	270 lbs.
†FC-3-2424	79"	30"	24" x 24"	N/A	0	None	243 lbs.
†FC-3-2424-18RorL	92.5"			18"	1	Specify	260 lbs.
†FC-3-2424-24RorL	98.5"			24"	1	Specify	281 lbs.
†FC-3-2424-18RL	108"			18"	2	R & L	295 lbs.
†FC-3-2424-24RL	120"			24"	2	R & L	315 lbs.
FC-3-2028-24RL	108"			34"	20" x 28"	24"	2
FC-3-2030-20RL	100"	36"	20" x 30"	20"	2	R & L	318 lbs.
FC-3-2030-24RL	108"			24"	2	R & L	330 lbs.
FC-3-2030-30RL	120"			30"	2	R & L	345 lbs.
†FC-3-2430	77"	36"	24" x 30"	N/A	0	None	225 lbs.
†FC-3-2430-24RorL	99"			24"	1	Specify	310 lbs.
†FC-3-2430-24RL	120"			24"	2	R & L	345 lbs.
†FC-3-2430-30RorL	105"			30"	1	Specify	335 lbs.
†FC-3-2430-30RL	132"			30"	2	R & L	370 lbs.
†FC-3-2430-36RorL	111"			36"	1	Specify	360 lbs.
†FC-3-2430-36RL	144"			36"	2	R & L	410 lbs.
†FC-3-3024	95"	30"	30" x 24"	N/A	0	None	225 lbs.
†FC-3-3024-24RorL	117"			24"	1	Specify	325 lbs.
†FC-3-3024-24RL	138"			24"	2	R & L	360 lbs.
†FC-3-3024-30RorL	123"			30"	1	Specify	350 lbs.
†FC-3-3024-30RL	150"			30"	2	R & L	395 lbs.
†FC-3-3024-36RorL	129"			36"	1	Specify	390 lbs.
†FC-3-3024-36RL	162"	36"	2	R & L	425 lbs.		
†FC-3-3030	95"	36"	30" x 30"	N/A	0	None	250 lbs.
†FC-3-3030-24RL	138"			24"	2	R & L	390 lbs.
†FC-3-3030-30RL	150"			30"	2	R & L	435 lbs.
†FC-3-3030-36RL	162"			36"	2	R & L	460 lbs.
†FC-4-1818-18RL	108"	30"	18" x 18"	18"	2	R & L	280 lbs.
†FC-4-1824-18RL	108"	30"	18" x 24"	18"	2	R & L	340 lbs.
†FC-4-2424-24RL	144"	30"	24" x 24"	18"	2	R & L	355 lbs.

† Requires Two Sets of Faucets



Customer Service Available To Assist You 1-800-645-3166 8:30 am - 7:00 pm E.S.T.

For Orders & Customer Service:

Email: customer@advancetabco.com or Fax: 631-242-6900

For Smart Fabrication™ Quotes:

Email: smartfab@advancetabco.com or Fax: 631-586-2933



# One Compartment - One Drainboard

## Stainless Steel Compartment Sinks



Use your smart phone to scan the above QR code to visit our website:  
www.bk-resources.com

### Certifications:



### Features:

- 1/4" Pitched Drainboards To Ensure Proper Drainage
- 1 1/2" Rounded Front and Side Edges
- Accommodates 8" On Center Faucets
- Drain Included
- 9" Backsplash

### Options:

- Pre-Rinse Units & Faucets
- Lever Drains
- Upgraded Bullet Feet
- Slant Rack Shelf (BK-SSH)
- End Splash (BKS-RES)
- S/S Basket Drain (BKDR-4-304)

### Material:

- T-304 18 ga. Stainless Steel Deck & Bowl
- 1 5/8" Galvanized Legs
- Adjustable High Impact Corrosion Resistant Feet
- Models ending with "S" have Stainless Steel Legs, End Bracing and Adjustable Stainless Steel over Plastic Bullet Feet

### Model #s ending with "S":

- T-304 18 ga. Stainless Steel Deck & Bowl
- Stainless Steel Legs
- Stainless Steel End Bracing
- Adjustable Stainless Steel over Plastic Bullet Feet

**\* Please specify Left or Right Drainboard**

Part Number	Unit Size (l x w)	Bowl Dim. (l x w x d)	Sets of Faucet Holes	Drainboard Size	Legs
BKS-1-1620-12-18L/R	36 1/2" x 25 13/16"	16" x 20" x 12"	1	(1)L/R - 18"	Galvanized
BKS-1-1620-12-18L/RS	36 1/2" x 25 13/16"	16" x 20" x 12"	1	(1)L/R - 18"	Stainless Steel w/ End Bracing
BKS-1-18-12-18L/R	38 1/2" x 23 13/16"	18" x 18" x 12"	1	(1)L/R - 18"	Galvanized
BKS-1-18-12-18L/RS	38 1/2" x 23 13/16"	18" x 18" x 12"	1	(1)L/R - 18"	Stainless Steel w/ End Bracing
BKS-1-1824-14-24L/R	44 1/2" x 29 13/16"	18" x 24" x 14"	1	(1)L/R - 24"	Galvanized
BKS-1-1824-14-24L/RS	44 1/2" x 29 13/16"	18" x 24" x 14"	1	(1)L/R - 24"	Stainless Steel w/ End Bracing
BKS-1-24-14-24L/R	50 1/2" x 29 13/16"	24" x 24" x 14"	1	(1)L/R - 24"	Galvanized
BKS-1-24-14-24L/RS	50 1/2" x 29 13/16"	24" x 24" x 14"	1	(1)L/R - 24"	Stainless Steel w/ End Bracing

PRODUCT DATA SHEET

RESOURCES





# One Compartment - One Drainboard

Stainless Steel Compartment Sinks

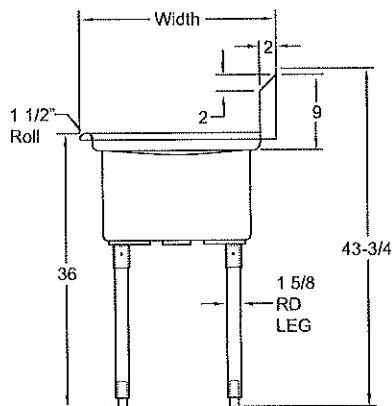
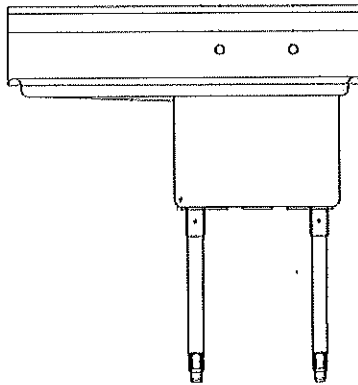
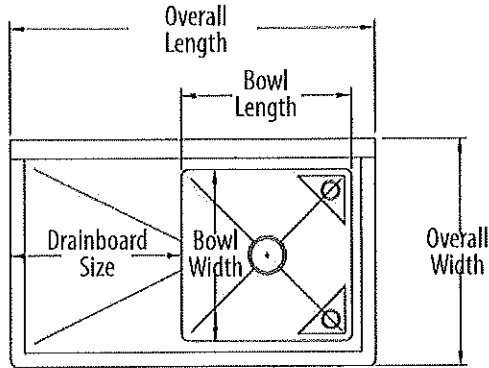

PRODUCT DATA SHEET

RESOURCES



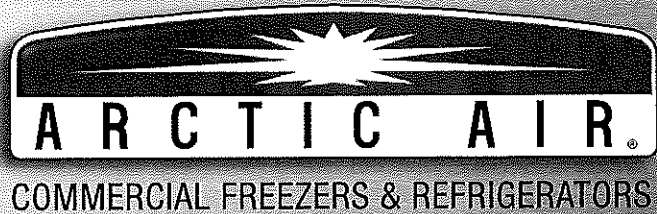

Stainless design.  
Stellar performance.  
Superior value.

AR49  
Refrigerator

AF49  
Freezer

## Two Door Reach-in Refrigerators and Freezers

- *Tested to NSF Standard 7 requirements for open food storage.*
- *Arctic Air products must pass numerous quality control inspections throughout the manufacturing process. All products are operated and monitored for a minimum of thirteen hours prior to packaging and shipping.*
- *All Arctic Air products come with full one year parts and labor warranties and a five year compressor warranty.*

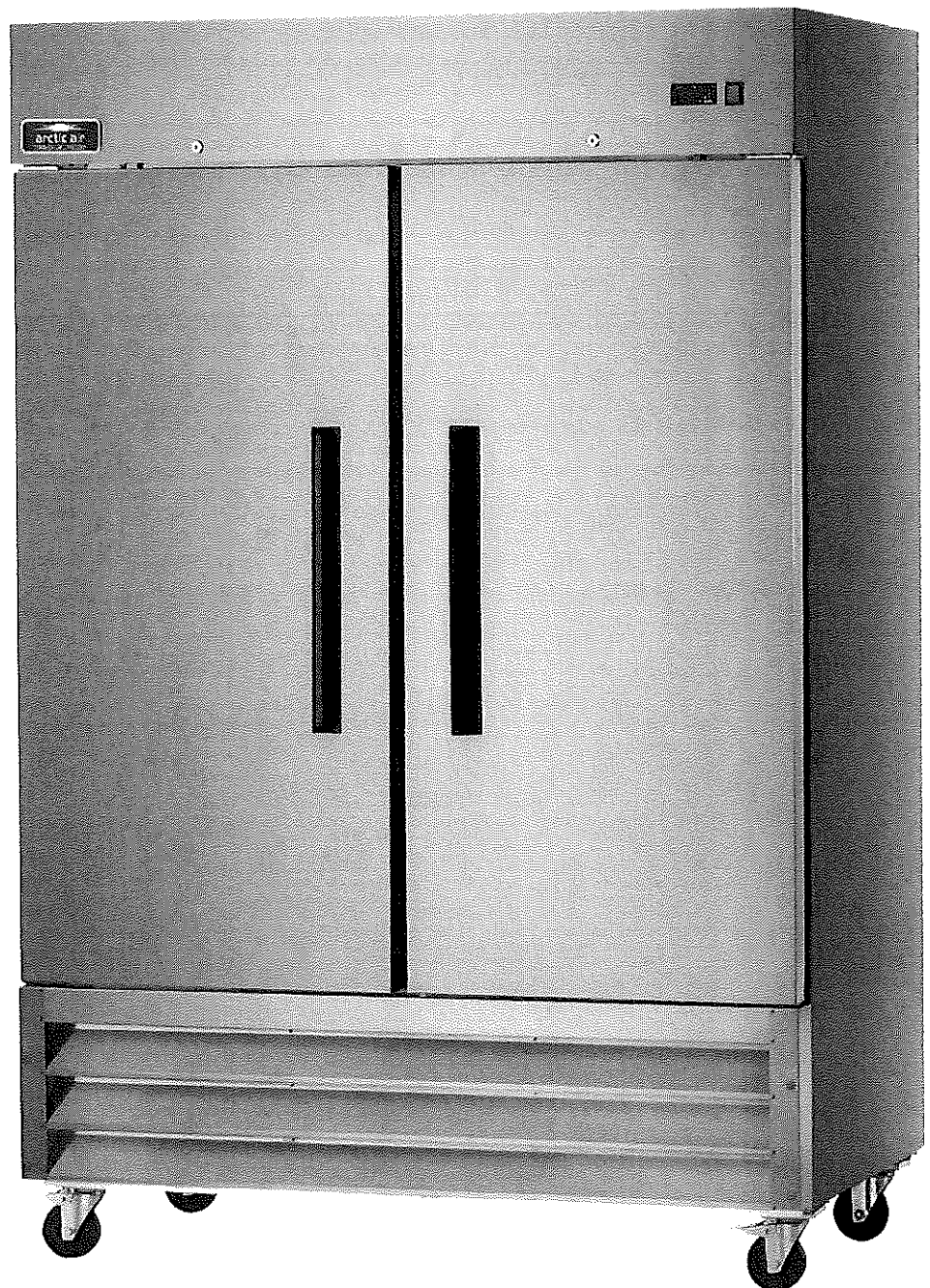

# Two Door Reach-in Refrigerators and Freezers

Stainless design. Stellar performance. Superior value.

- 
- Exterior cabinet construction consists of full stainless steel front and sides.
  - Electronic thermostat with external digital LED display for accurate control and easy reading.
  - Interior cabinet is bright white aluminum liner with full stainless steel floor with coved corners.
  - Six adjustable, heavy-duty epoxy coated wire shelves.
  - Self contained capillary tube system using environmentally friendly CFC free refrigerant (R404A in freezers and R134A in refrigerators).
  - Condensate heating element built into condensate pan for efficient evaporation of excess water.
  - Bottom mounted compressor for more efficient operation in coolest area of the kitchen.
  - Front accessible, bottom mounted condensing unit is mounted on slide out rack for easy maintenance.
  - Self closing doors that remain open at 90 degrees.
  - Magnetic door gaskets are removable and replaceable without tools.
  - Freezer doors have integral factory installed heating element to eliminate condensation.
  - Lockable doors with foamed-in-place recessed handles.
  - Larger fan motors and blades for more efficient air flow ensuring faster recovery times.
  - Easy to mount casters (two lockable) are standard with all units.
  - Tested to NSF Standard 7 requirements for open food storage.
  - All Arctic Air products come with full one year parts and labor warranties and a five year compressor warranty.

Model Number	External Dimensions			Doors	Shelves	Cubic Feet	Temperature Range	Cord Length	HP	Amps	NEMA Plug	Crated Weight (lbs.)
	Width	Depth*	Height**									
<b>AR49</b>	54"	32.75"	82.75"	2	6	49	33°F to 41°F	9	1/2	7	5-15P	455
<b>AF49</b>	54"	32.75"	82.75"	2	6	49	-10°F to +10°F	9	1	12	5-15P	485

\*Depth with door open 90° — AR49/AF49 = 57.75"    \*\*Height includes 6" for casters

#### Optional Shelf Kit (#65056K)

Each kit contains one shelf and four mounting clips.

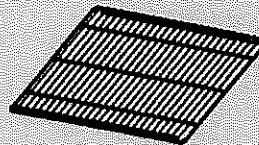

COMMERCIAL FREEZERS & REFRIGERATORS



Division of Broich Enterprises, Inc. 6440 City West Parkway Eden Prairie, MN 55344  
952-941-2270 Fax: 952-941-3066 www.arcticairco.com info@arcticairco.com





Stainless design,  
Stellar performance.  
Superior value.

Project name: \_\_\_\_\_

Location: \_\_\_\_\_

Item #: \_\_\_\_\_ QTY: \_\_\_\_\_

Model #: \_\_\_\_\_

# AF23 FREEZER

## SINGLE DOOR REACH-IN FREEZER

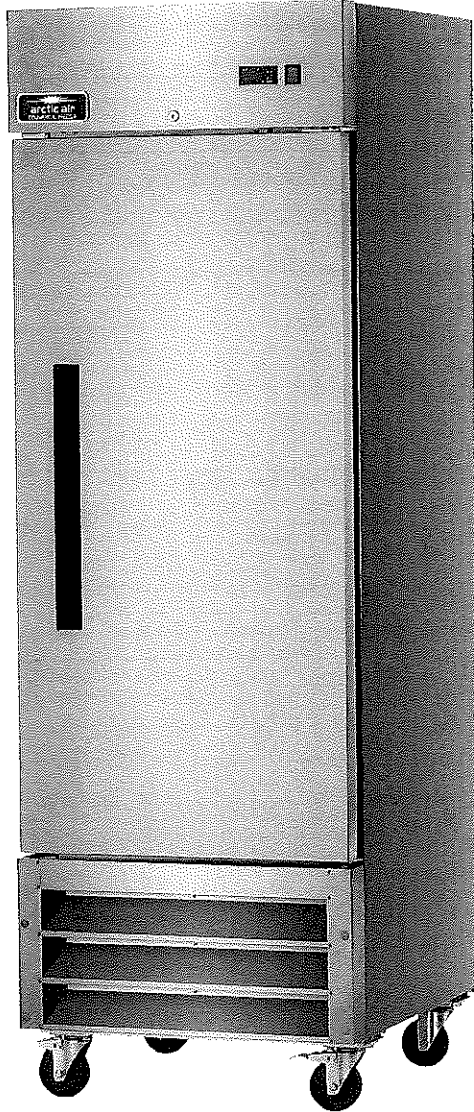

### AF23

- ▶ Tested to NSF Standard 7 requirements for open food storage.
- ▶ Standard with full two year parts and labor warranty and a five year compressor warranty.
- ▶ Arctic Air products must pass numerous quality control inspections throughout the manufacturing process.
- ▶ All products are pressurized with environmentally friendly and more efficient Hydrocarbon gas.
- ▶ Energy Star Approved



Division of Broich Enterprises, Inc. 7550 Market Place Dr Eden Prairie, MN 55344  
952-941-2270 Fax: 952-941-3066 www.arcticairco.com info@arcticairco.com



# AF23 FREEZER

# SINGLE DOOR REACH-IN FREEZER

Electronic thermostat with external digital LED display for accurate control and easy reading.

Interior cabinet is bright white aluminum liner with full stainless steel floor with coved corners.

Three adjustable, heavy-duty epoxy coated wire shelves.

Self-contained capillary tube system using environmentally friendly R290 Hydrocarbon gas.

Exterior cabinet construction consists of full stainless steel front and sides.

Efficient condensate hot gas loop built into condensate pan for energy saving evaporation of excess condensate water.

Bottom mounted compressor for more efficient operation in coolest area of kitchen.

Front accessible, bottom mounted condensing unit is mounted on slide out rack for easy maintenance.

Easy to mount plate casters (two lockable) are standard with all units.

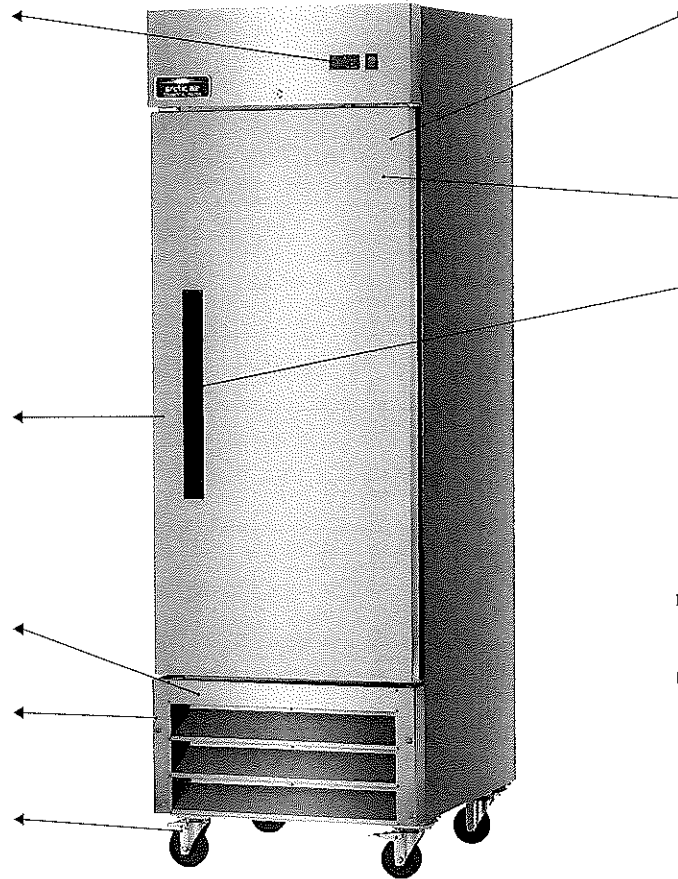

Vaulted self closing doors that remain open at 90 degrees.

Freezer door frame has integral factory installed heating element to eliminate condensation.

Magnetic door gasket is removable and replaceable without tools.

Field reversible, lockable door with foamed-in-place recessed handle.

Larger fan motors and blades for more efficient air flow ensuring faster recovery times.

Unit holds full size sheet pans front to back. With optional s/s Pan Slide rack (#64900K). Some field install is required.

▶ Tested to NSF Standard 7 requirements for open food storage.

▶ Standard with full two year parts and labor warranties and a five year compressor warranty.

## STAINLESS STEEL DESIGN • STELLAR PERFORMANCE • SUPERIOR VALUE

Model Number	External Dimensions			Doors	Epoxy Coated Shelves (horizontal)	Cubic Feet	Temperature Range	Cord Length	HP	AMPS	REF	NEMA Plug	Crate Weight
	Width	Depth	Height*										
AF23	26.75"	32.75"	82.75"	1	3	23	-10°F to 10°F	8'	4/5	8.0	R290	5-15P	325Lbs

Depth with door open 90° = 59.50"

\*Height includes 6" for casters

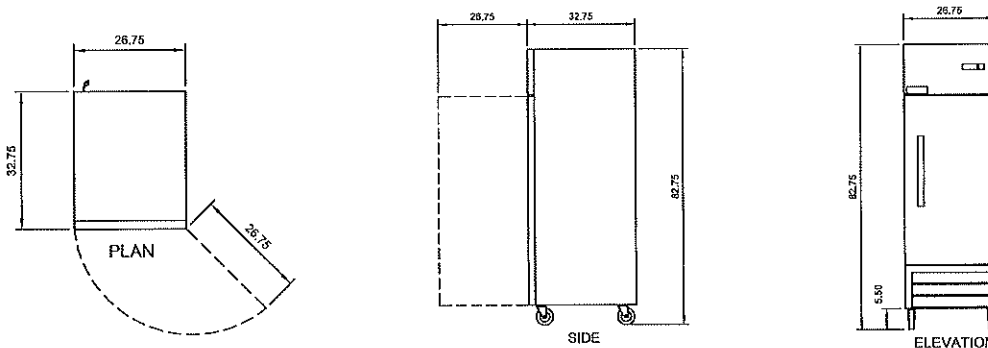

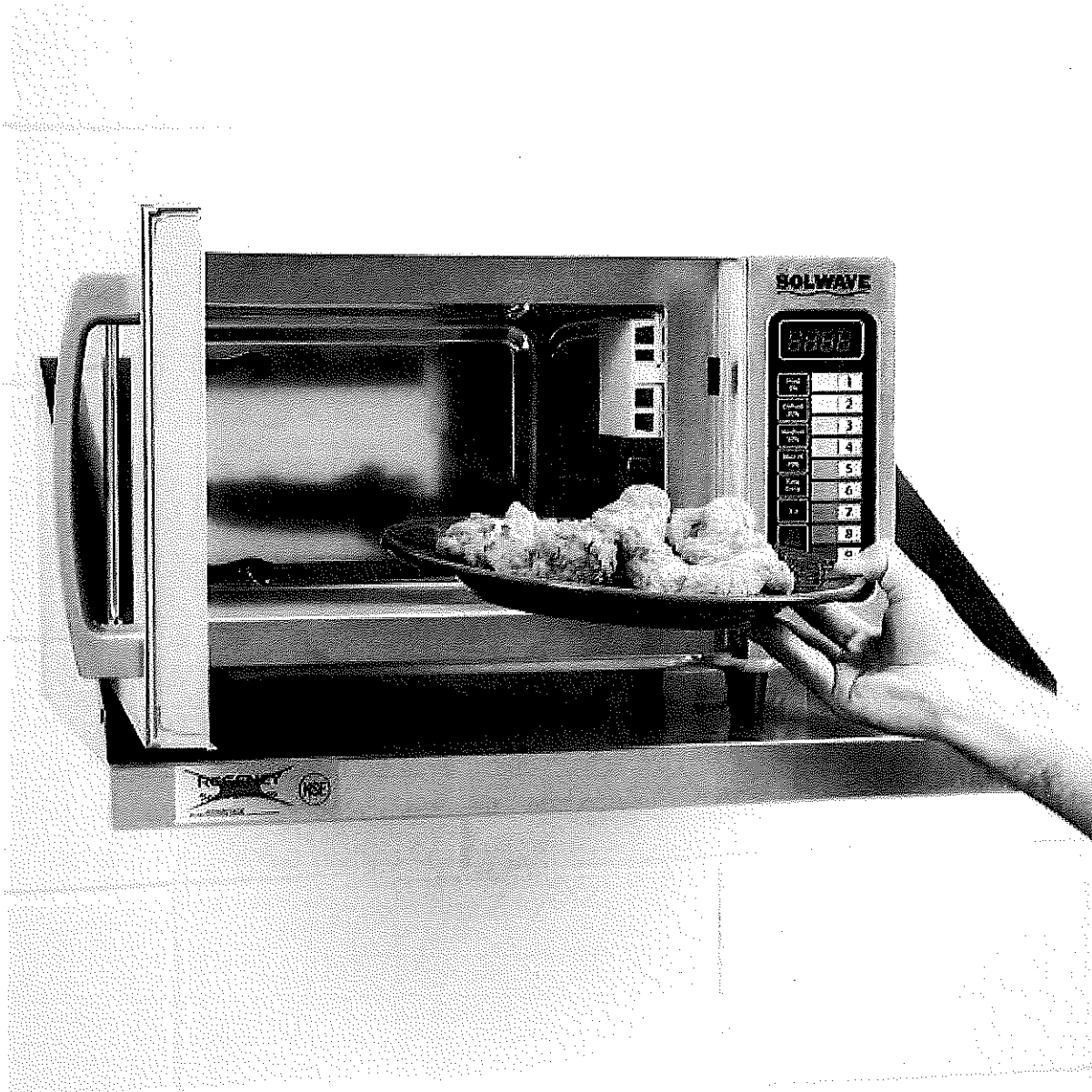

Note: \* Usually ships within 4 hours when ordered Monday-Friday before 12:00 PM EST

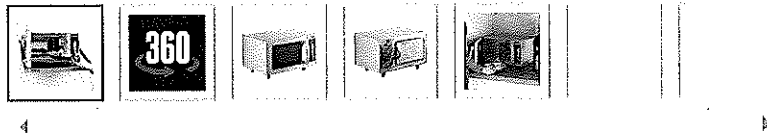

Free Shipping

Only

**\$259.99/Each**

Ships free with

**What We Offer**



**Protect Your Product**  
Coverage starting at \$46.99

Add Protection



Add to Cart



Earn up to \$7.80 back (780 points) with a Webstaurant Rewards Visa® Credit Card

Wish List

Rapid Reorder

- ✓ Durable stainless steel exterior and interior
- ✓ 0.9 cu. ft. capacity accommodates (1) 1/2 size 6" deep food pan with cover
- ✓ 10 programmable memories, including defrost
- ✓ 1000W of power with 4 settings provide a variety of cooking options
- ✓ See-through door and lighted interior to monitor cooking

UPC Code:

400010971381



Quick Shipping

Usually ships in 1 business day

# SOLWAVE

View all Solwave Commercial Microwaves

## Products Suggested For You

plus

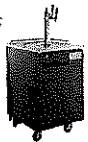

Avantco UDD-1-HC Triple Tap Kegerator Beer  
\$1,549.00 / Each

1 Add to Cart

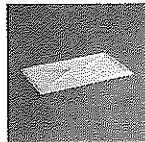

Avantco 17818256 Flat Night Cover for Ice Cream  
\$72.49 / Each

1 Add to Cart

plus

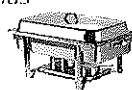

Choice Deluxe 8 Qt. Full Size Gold Accent Chafer  
\$59.99 / Each

1 Add to Cart

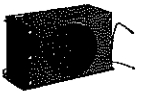

1 Add to

## You May Also Need

plus



Regency 24" x 18" Stainless Steel Microwave Shelf  
\$84.99 / Each

1 Add to Cart

plus



Cambro 24HP150 H-Pan™ 1/2 Size Amber High Heat  
\$20.49 / Each

1 Add to Cart

plus



Cambro 22HP150 H-Pan™ 1/2 Size Amber High Heat  
\$15.49 / Each

1 Add to Cart

plus



1 Add to

NEED HELP? 1-877-  
CALL US: 453-5077

CHAT

PHONE SUPPORT: MON-FRI 7:30AM-4PM (PST) CONTACT



(0)



**ELITE**  
TOOLBOXES

What are you looking for?

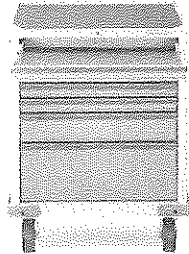
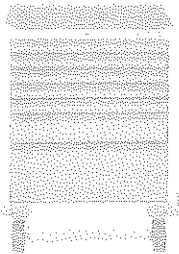
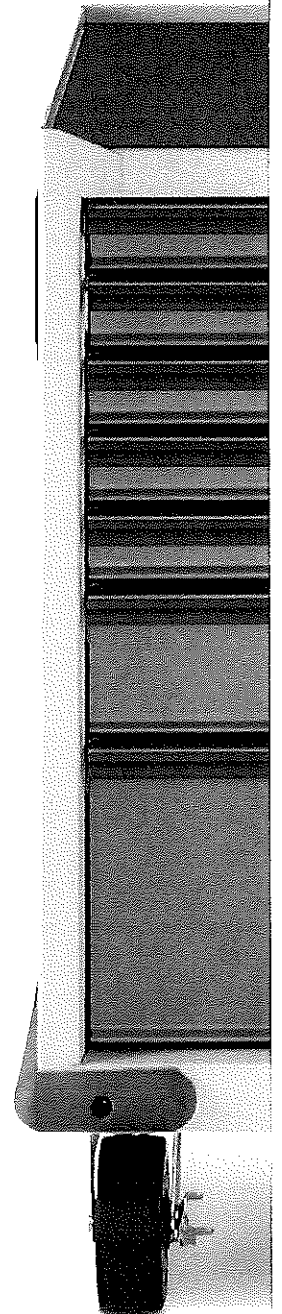
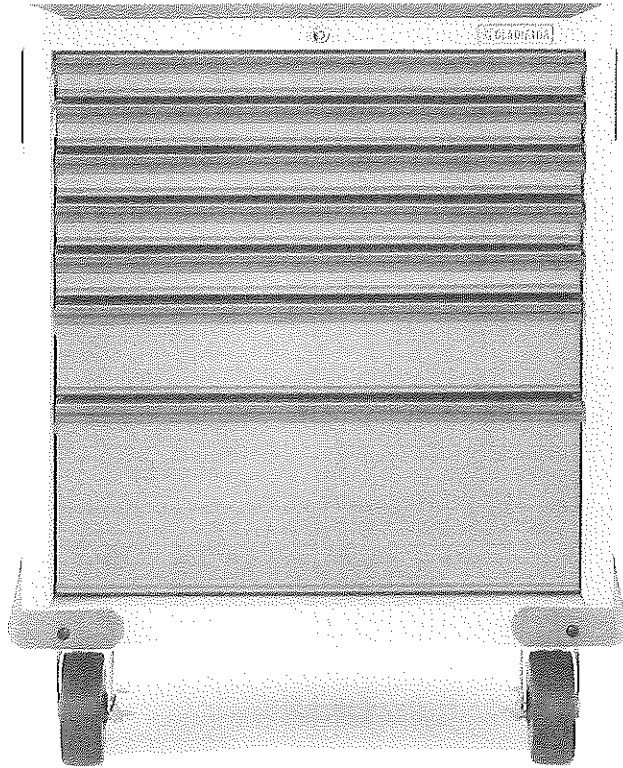

# GLADIATOR PREMIER WHITE SERIES 7-DRAWER MODULAR TOOL STORAGE CABINET

**TALK TO US**

(yet)

NEED HELP? 1-877-  
CALL US: 453-5077

CHAT PHONE SUPPORT: MON-FRI 7:30AM-4PM (PST) CONTACT



(0)



**ELITE**  
TOOLBOXES

What are you looking for?

- 1 +

ADD TO CART



### DESCRIPTION

### SPECIFICATIONS

At two feet deep, the Premier Modular 7 Drawer GearDrawer cabinet and tool storage capacity over our typical 18" deep cabinets. Each features solid metal drawer handles, rides on full-extension ball bearing operation and includes cushioned drawer liners. Built for storage with welded steel double-side wall construction that allows for exceptional support for storage needs. Have easy access to tools with large top handles. Ideal for medium to small hand tools. Provides mobile tool storage with heavy-duty solid rubber 5 in. x 2 in. caster wheels that increase mobility. Front casters lock to hold the unit in place while swiveling rear casters make unit easy to move and dock under modular workbenches.

- 28" W X 25.5" D X 35" (w/casters and bumpers)
- Heavy-duty welded steel construction supports up to 1500 lbs.
- Holds up to 1,400 lbs per cabinet and 65 lbs per drawer
- Front and rear wheel casters delivery mobility
- 7 full-extension drawers simplify organization
- Hassle-free Lifetime limited warranty

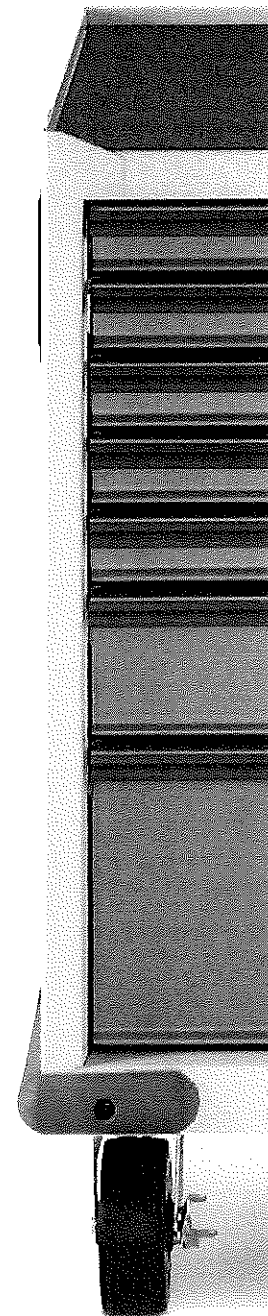

## RELATED PRODUCTS



## Model 35C+ & 45C+ Economy Tube Fired Gas Fryers

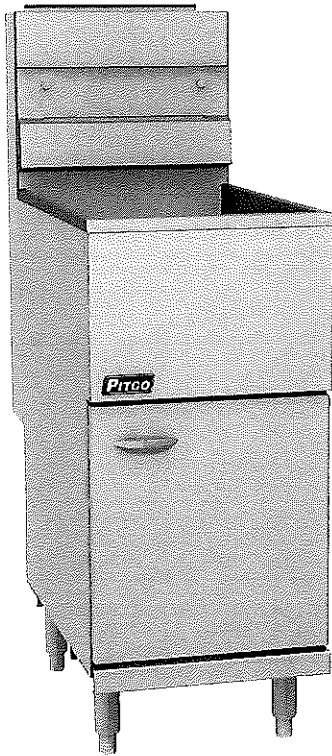

### STANDARD ACCESSORIES

- Cabinet - stainless steel front, door
- Galvanized sides and back
- Tank - stainless steel
- Built-in integrated flue deflector
- Two nickel plated oblong, wire mesh baskets
- One nickel-plated tube rack
- One drain extension
- One drain line clean-out rod
- Removable basket hanger for easy cleaning
- 6" (15.2 cm) adjustable legs

### AVAILABLE OPTIONS & ACCESSORIES

- Triple baskets
- Covers
- Fryer cleaner
- Casters

Project \_\_\_\_\_

Item No. \_\_\_\_\_

Quantity \_\_\_\_\_

### STANDARD SPECIFICATIONS

#### CONSTRUCTION

- Welded tank with an extra smooth peened finish ensures easy cleaning.
- Long-lasting, high-temperature alloy stainless steel heat baffles are mounted in the heat exchanger tubes to provide maximum heating and combustion efficiency.
- Standing pilot light design provides a ready flame when heat is required.
- Cabinet front and door are constructed of stainless steel with galvanized sides and back.

#### CONTROLS

- Thermostat maintains selected temperature automatically between 200°F (93°C) and 400°F (190°C-CE).
- Integrated gas control valve acts as a manual and pilot valve, automatic pilot valve, gas filter, pressure regulator (MAX ½ PSI SUPPLY), and automatic main valve.
- Gas control valve prevents gas flow to the main burner until pilot is established and shuts off all gas flow automatically if the pilot flame goes out.
- Temperature limit switch safely shuts off all gas flow if the fryer temperature exceeds the upper limit.

#### OPERATIONS

- Front 1-1/4" (3.2 cm) NPT drain for quick draining.
- Standing pilot and thermostat maintain temperature automatically at the selected temperature (between 200°F (93°C) and 400°F (190°C-CE)).

Please note: 35C+ is only model "CE" approved

Model 35C+ & 45C+ Economy Tube Fired Gas Fryers



# Model 35C+ & 45C+ Economy Tube Fired Gas Fryers

## Model 35C+ & 45C+ Economy Tube Fired Gas Fryers

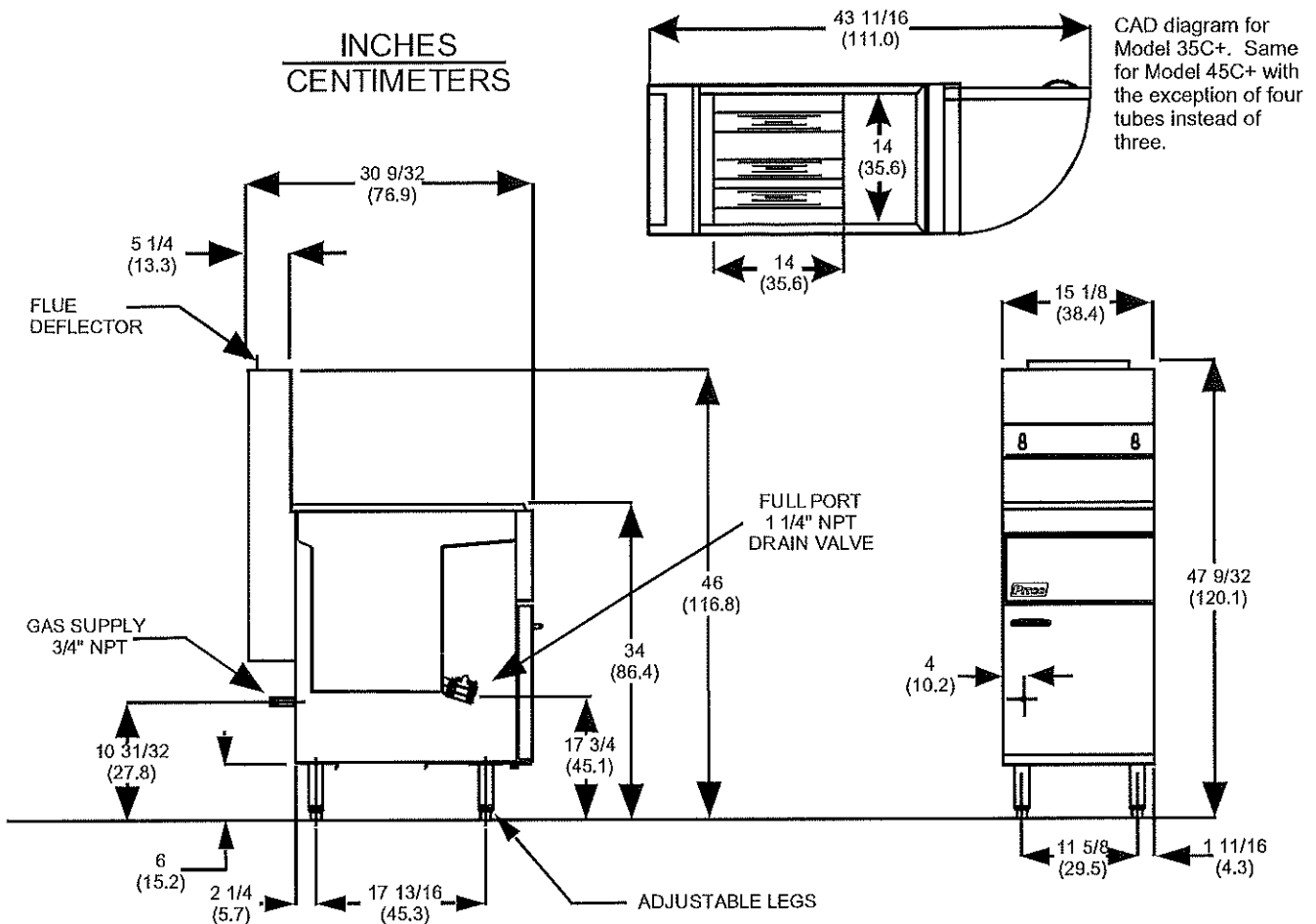

ELECTRICAL		OIL CAPACITY	
No Electrical options available		35-40 lbs (15.9 - 18.1 kg)- Model 35C+	
		42-50 lbs (19.1 - 22.7 kg)- Model 45C+	
SHIPPING INFORMATION (Approximate)			
161 lbs (73 kg) / 17.0 cubic feet (0.48 cubic meters) Model 35C+			
181 lbs (82 kg) / 17.0 cubic feet (0.48 cubic meters) Model 45C+			
GAS CONSUMPTION		PERFORMANCE CHARACTERISTICS	
90,000 BTU's/Hour (26.3 kW) 122,000 BTU's/Hour (35.7 kW) Available in Natural or Propane Gas. For other Fuel types contact your Dealer/Distributor.		Cooks 50.2 lbs. (22.7 KG) of fries per hour.-Model 35C+ Cooks 66.2 lbs. (30.0 KG) of fries per hour.-Model 45C+ Frying area is 14" x 14" (35.6 x 35.6 cm)	
Gas requirement for Incoming Pressure	NATURAL	PROPANE	
	7 - 9 inches	11 - 12 inches	
SHORT FORM SPECIFICATION			
Provide Pitco 35C+, or 45C+ tube-fired gas fryer. Fryer shall have an atmospheric burner system combined with three stainless steel tubes (Model 45C+ has four tubes) utilizing high temperature alloy stainless steel baffles. Fryer shall have a deep cool zone; minimum 20% of total oil capacity. Fryer cooking area shall be 14" x 14" (35.7 x 35.7 cm) with a cooking depth of 2-3/4" (7.00 cm). Model 45C+ has cooking depth of 4" (10.16 cm). Heat transfer area shall be a minimum of 588 square inches (3794 sq cm) for 35C+. Heat transfer area shall be a minimum of 785 square inches (5058 sq cm) for 45C+. Provide accessories as follows:			
TYPICAL APPLICATION			
Frying a wide variety of foods in a limited amount of space. Frying that requires a high volume production rate.			



Pitco Frialator, Inc., P.O. Box 501, Concord, NH 03302-0501 • 553 Route 3A, Bow NH 03304, USA  
Phone • (603) 225-6684 • Fax (603) 225-8472 • [www.pitco.com](http://www.pitco.com) L10-144 Rev 14 (03/19) Printed in the USA

We reserve the right to change specifications without notice and without incurring any obligation for equipment previously or subsequently sold.

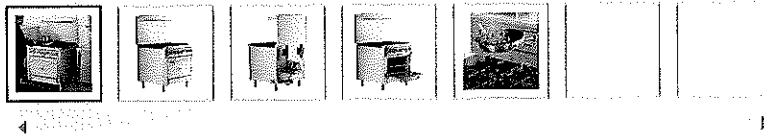

Free Shipping

Only

**\$3,149.00/Each**

Ships free with

**What We Offer**



Protect Your Product  
Coverage starting at \$113.85

Add Protection

1

*plus*  Avantco A-49R-HC  
54" Solid Door  
Reach-In  
\$2,899.00 / Each

1 Add to Cart

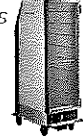
*plus*  Avantco HEAT-  
1836 Full Size  
Non-Insulated  
\$1,449.00 / Each

1 Add to Cart

*plus*  Cooking  
Performance  
Group  
\$18.49 / Each

1 Add to Cart

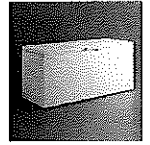

1 Add to

### You May Also Need

[View All Items](#)

 Cooking  
Performance  
Group  
\$44.99 / Each

1 Add to Cart

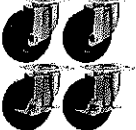
 Cooking  
Performance  
Group  
\$106.99 / Set

1 Add to Cart

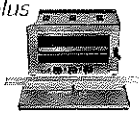
*plus*  Cooking  
Performance  
Group S-36-SB-N  
\$1,499.00 / Each

1 Add to Cart

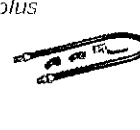
*plus* 

1 Add to

## Boost your kitchen's efficiency, reliability, and overall performance with this Cooking Performance Group C36-N gas range!

A combination of 6 open top burners and a spacious convection oven make this natural gas range a tremendous asset to your commercial kitchen! You can effortlessly boil, saute, simmer, and perform a variety of other cooking tasks on the heavy-duty cast iron grates, and the oven provides you with a convenient way to warm your delicious foods or even do some baking for your dessert menu!



**5-15P**  
This unit comes with a NEMA 5-15P plug.

### Open Top Burners

This range boasts (6) 30,000 BTU open top burners to deliver the impressive cooking performance you demand. The independently controlled burners mean you can simultaneously execute a wide variety of tasks while their 12"x12" heavy-duty cast iron grates support your sauce pans, fry pans, and other cookware.

### Removable Grates

The cast iron grates lift off for simple yet thorough end of day cleaning.

What are you looking for?

Product Categories

Restaurant (restaurant-equipment.html)

Countertop (countertop-restaurant-equipment.html)

Home (1) / Shop by Manufacturer (/shop-by-manufacturer.html) / Imperial (/imperial.html)

# Imperial PCVE-2 - Convection Oven, electric, (2) deck, dual open 60/40 doors

Manufacturing Id: PCVE-2



(assets/images/products/impe/imperial-icve-2-convection-oven.jpg)

Image may include accessories and may not necessarily depict product color.

**CALL CENTER IS: OPEN**  
**(866) 780-3747**  
**CALL US NOW!**

(tel:(866) 780-3747)

 This Item Ships Free

Your Price: **\$11,933.00** /Each

Add to Cart

Commercial Financing as low as \$298.32/mo

(tel:(866) 780-3747)

For Current Lead Time  Chat Now

Voltages

Please Select

Shipping Options



Residential / Limited Access [+\$50.00]

Lift Gate [+\$60.00]



([https://jesrestaurantequipment.us8.list-manage.com/subscribe/post?](https://jesrestaurantequipment.us8.list-manage.com/subscribe/post?u=51d6b4f185a03352d685297e2&id=c66069f1d0)

u=51d6b4f185a03352d685297e2&id=c66069f1d0)

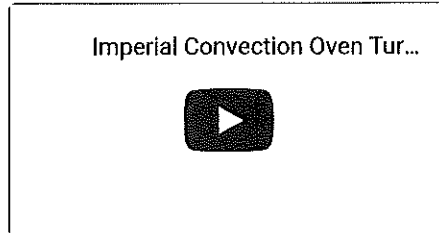

Download the PCVE-2 PDF Spec Sheet > (<http://www.jesrestaurantequipment.com/assets/spec-sheets/2028/IMP0308A.pdf>)

The manufacturer provides these spec sheets for exact measurements, voltage options and requirements, and additional product options.

Download Spec Sheet (<http://www.jesrestaurantequipment.com/assets/spec-sheets/2028/IMP0308A.pdf>)

## Description

### Specifications

- Convection Oven
- electric
- (2) deck
- manual controls
- (2) speed fan motor
- dual open 60/40 doors
- window
- (5) racks per deck
- interior lights
- stainless steel front, sides, doors, top & legs
- cETLus, ETL-Sanitation, CE

**WARNING:** Attention California Residents - Prop 65 Warning

(<http://www.P65Warnings.ca.gov>)



Write a Review Ask a Question

### Have a Question?

CALL (866) 780-3747 (TEL:(866) 780-3747) CHAT

Talk to a Real Person! Mon-Fri 8am-6pm EST

# Big John Grills 6SDG 102" Towable Charcoal BBQ Grill Single Door 15 Sq.Ft Grill

BIG JOHN GRILLS Model: 6SDG SKU 111052



**SALE PRICE**  
**\$3,269.58** / each

Pickup Not Available

### Similar Models Available:



[New 6SDR for \\$4,078.52](#)



[New RW6SDG for \\$5,987.66](#)