

RE: 24052557
 BCTH-25

Trenco
 818 Soundside Rd
 Edenton, NC 27932

Site Information:

Customer: TRUE HOMES RALEIGH Project Name: 24052557
 Lot/Block: 25 Model: Lucas TH @ Buies Creek
 Address: 200 Camel Craziess Place Subdivision: BCTH
 City: Lillington State: NC

General Truss Engineering Criteria & Design Loads (Individual Truss Design Drawings Show Special Loading Conditions):

Design Code: IRC2015/TPI2014 Design Program: MiTek 20/20 8.7
 Wind Code: N/A Wind Speed: N/A mph
 Roof Load: N/A psf Floor Load: 55.0 psf

This package includes 15 individual, dated Truss Design Drawings and 0 Additional Drawings.

No.	Seal#	Truss Name	Date
1	I65332716	F3	5/3/2024
2	I65332717	F4	5/3/2024
3	I65332718	L02	5/3/2024
4	I65332719	F2	5/3/2024
5	I65332720	F1	5/3/2024
6	I65332721	L01	5/3/2024
7	I65332722	L03	5/3/2024
8	I65332723	F5	5/3/2024
9	I65332724	F6	5/3/2024
10	I65332725	F7	5/3/2024
11	I65332726	F8	5/3/2024
12	I65332727	F10	5/3/2024
13	I65332728	L04	5/3/2024
14	I65332729	F9	5/3/2024
15	I65332730	L05	5/3/2024

The truss drawing(s) referenced above have been prepared by Truss Engineering Co. under my direct supervision based on the parameters provided by The Building Center.

Truss Design Engineer's Name: Gilbert, Eric

My license renewal date for the state of North Carolina is December 31, 2024.

North Carolina COA: C-0844

IMPORTANT NOTE: The seal on these truss component designs is a certification that the engineer named is licensed in the jurisdiction(s) identified and that the designs comply with ANSI/TPI 1. These designs are based upon parameters shown (e.g., loads, supports, dimensions, shapes and design codes), which were given to TRENCO. Any project specific information included is for TRENCO customers file reference purpose only, and was not taken into account in the preparation of these designs. TRENCO has not independently verified the applicability of the design parameters or the designs for any particular building. Before use, the building designer should verify applicability of design parameters and properly incorporate these designs into the overall building design per ANSI/TPI 1, Chapter 2.



May 03, 2024

Job 24052557	Truss F3	Truss Type Floor Girder	Qty 1	Ply 1	BCTH-25 Job Reference (optional)	I65332716
-----------------	-------------	----------------------------	----------	----------	-------------------------------------	-----------

The Building Center, Gastonia, NC - 28052,

8.730 s Apr 25 2024 MiTek Industries, Inc. Thu May 2 14:43:39 2024 Page 1
ID:sWUVkoBcB7eFy0GbrIE06iy7HxI-9MEqZIZqKOqU70bsmJeL8FWxvVkyRvYUgc34uBzKVwl

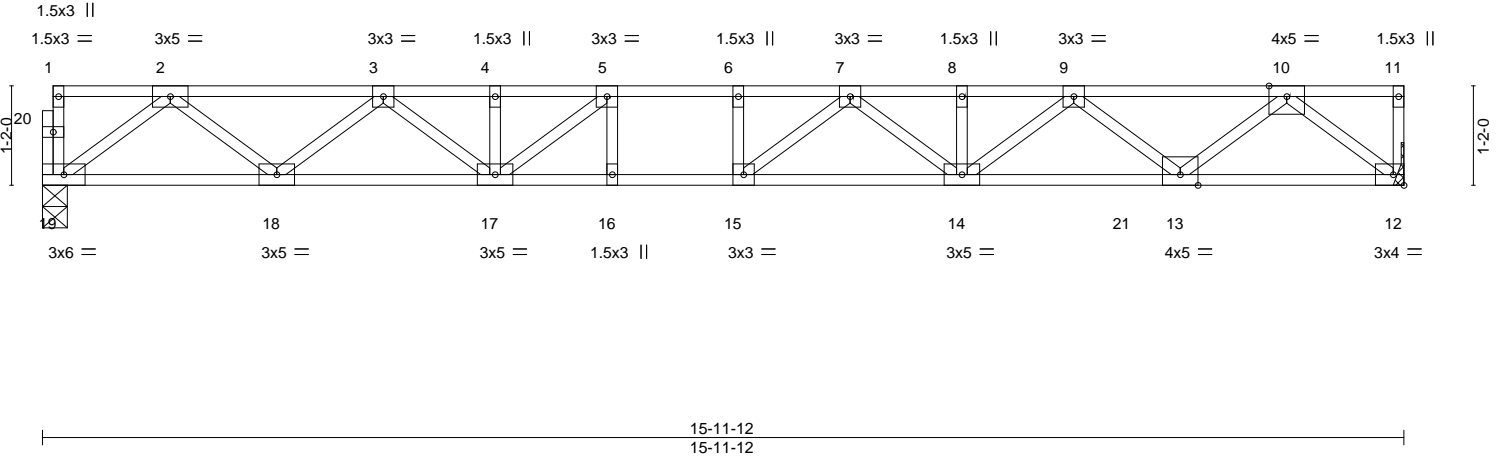
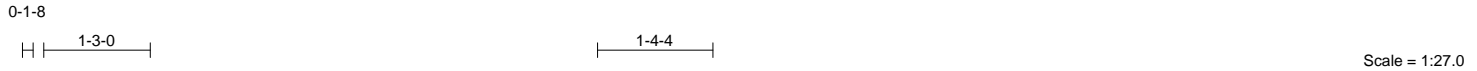

LOADING (psf)	SPACING-	2-0-0	CSI.	DEFL.	in (loc)	l/defl	L/d	PLATES	GRIP
TCLL 40.0	Plate Grip DOL	1.00	TC 0.71	Vert(LL)	-0.23 14-15	>818	360	MT20	244/190
TCDL 10.0	Lumber DOL	1.00	BC 0.88	Vert(CT)	-0.32 14-15	>591	240		
BCLL 0.0	Rep Stress Incr	NO	WB 0.56	Horz(CT)	0.06 12	n/a	n/a		
BCDL 5.0	Code IRC2015/TPI2014		Matrix-S					Weight: 82 lb	FT = 20%F, 11%E

LUMBER-
TOP CHORD 2x4 SP No.2(flat)
BOT CHORD 2x4 SP No.1(flat)
WEBS 2x4 SP No.3(flat)

BRACING-
TOP CHORD Structural wood sheathing directly applied or 6-0-0 oc purlins, except end verticals.
BOT CHORD Rigid ceiling directly applied or 10-0-0 oc bracing.

REACTIONS. (size) 19=0-3-8, 12=Mechanical
Max Grav 19=890(LC 1), 12=1112(LC 1)

FORCES. (lb) - Max. Comp./Max. Ten. - All forces 250 (lb) or less except when shown.
TOP CHORD 2-3=-1859/0, 3-4=-3019/0, 4-5=-3019/0, 5-6=-3442/0, 6-7=-3442/0, 7-8=-3159/0, 8-9=-3159/0, 9-10=-2122/0
BOT CHORD 18-19=0/1114, 17-18=0/2565, 16-17=0/3442, 15-16=0/3442, 14-15=0/3418, 13-14=0/2763, 12-13=0/1224
WEBS 2-19=-1395/0, 2-18=0/970, 3-18=-919/0, 3-17=0/579, 5-17=-749/0, 10-12=-1562/0, 10-13=0/1169, 9-13=-835/0, 9-14=0/505, 7-14=-331/0, 7-15=-237/334

- NOTES-**
- 1) Unbalanced floor live loads have been considered for this design.
 - 2) Refer to girder(s) for truss to truss connections.
 - 3) Recommend 2x6 strongbacks, on edge, spaced at 10-0-0 oc and fastened to each truss with 3-10d (0.131" X 3") nails. Strongbacks to be attached to walls at their outer ends or restrained by other means.
 - 4) CAUTION, Do not erect truss backwards.
 - 5) In the LOAD CASE(S) section, loads applied to the face of the truss are noted as front (F) or back (B).

LOAD CASE(S) Standard
1) Dead + Floor Live (balanced): Lumber Increase=1.00, Plate Increase=1.00
Uniform Loads (plf)
Vert: 19-21=-10, 12-21=-95(B=-85), 1-11=-100

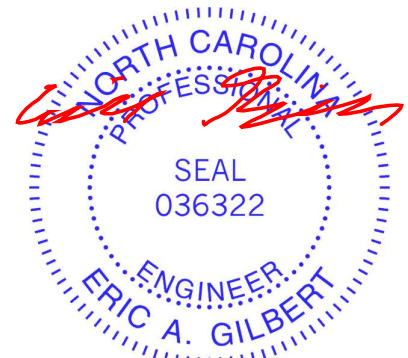

May 3, 2024

WARNING - Verify design parameters and READ NOTES ON THIS AND INCLUDED MITEK REFERENCE PAGE MII-7473 rev. 1/2/2023 BEFORE USE.
Design valid for use only with MiTek® connectors. This design is based only upon parameters shown, and is for an individual building component, not a truss system. Before use, the building designer must verify the applicability of design parameters and properly incorporate this design into the overall building design. Bracing indicated is to prevent buckling of individual truss web and/or chord members only. Additional temporary and permanent bracing is always required for stability and to prevent collapse with possible personal injury and property damage. For general guidance regarding the fabrication, storage, delivery, erection and bracing of trusses and truss systems, see **ANSI/TPH Quality Criteria and DSB-22** available from Truss Plate Institute (www.tpinst.org) and **BCSI Building Component Safety Information** available from the Structural Building Component Association (www.sbcacomponents.com)



818 Soundside Road
Edenton, NC 27932

Job 24052557	Truss L02	Truss Type GABLE	Qty 1	Ply 1	BCTH-25 Job Reference (optional)	I65332718
-----------------	--------------	---------------------	----------	----------	-------------------------------------	-----------

The Building Center, Gastonia, NC - 28052,

8.730 s Apr 25 2024 MiTek Industries, Inc. Thu May 2 14:43:42 2024 Page 1
ID:sWUVkoBcB7eFy0GbrlE06iy7Hxl-axvzCKbjdJC3_TJRRSB2mt8byjyBe_vwNZlIVWzKVwF

0,1,8

Scale = 1:19.4

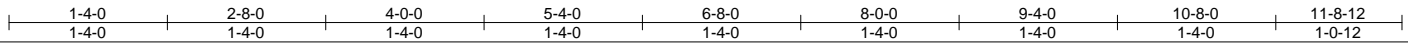
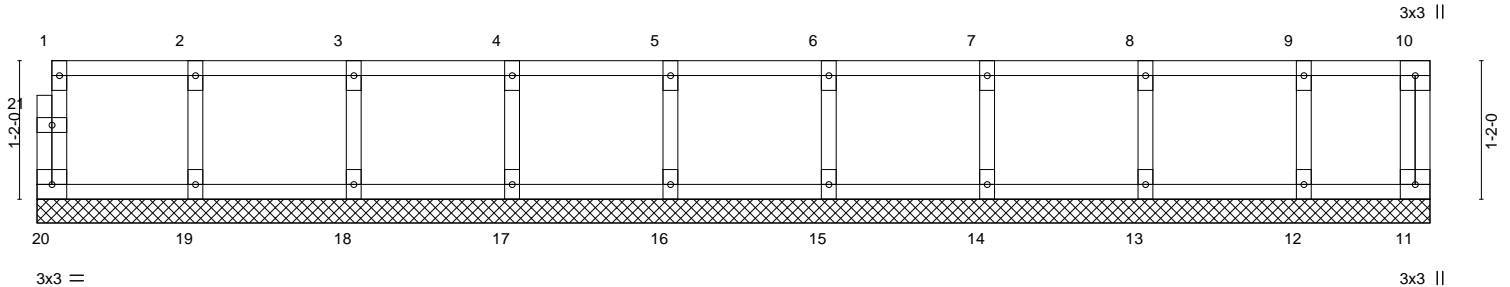

LOADING (psf)	SPACING-	2-0-0	CSI.	DEFL.	in (loc)	l/defl	L/d	PLATES	GRIP	
TCLL 40.0	Plate Grip DOL	1.00	TC 0.08	Vert(LL)	n/a	-	n/a	999	MT20	244/190
TCDL 10.0	Lumber DOL	1.00	BC 0.01	Vert(CT)	n/a	-	n/a	999		
BCLL 0.0	Rep Stress Incr	YES	WB 0.03	Horz(CT)	0.00	11	n/a	n/a		
BCDL 5.0	Code IRC2015/TPI2014		Matrix-R							
									Weight: 51 lb	FT = 20%F, 11%E

LUMBER-
TOP CHORD 2x4 SP No.2(flat)
BOT CHORD 2x4 SP No.2(flat)
WEBS 2x4 SP No.3(flat)
OTHERS 2x4 SP No.3(flat)

BRACING-
TOP CHORD Structural wood sheathing directly applied or 6-0-0 oc purlins, except end verticals.
BOT CHORD Rigid ceiling directly applied or 10-0-0 oc bracing.

REACTIONS. All bearings 11-8-12.
(lb) - Max Grav All reactions 250 lb or less at joint(s) 20, 11, 19, 18, 17, 16, 15, 14, 13, 12

FORCES. (lb) - Max. Comp./Max. Ten. - All forces 250 (lb) or less except when shown.

- NOTES-**
- 1) All plates are 1.5x3 MT20 unless otherwise indicated.
 - 2) Gable requires continuous bottom chord bearing.
 - 3) Truss to be fully sheathed from one face or securely braced against lateral movement (i.e. diagonal web).
 - 4) Gable studs spaced at 1-4-0 oc.
 - 5) Recommend 2x6 strongbacks, on edge, spaced at 10-0-0 oc and fastened to each truss with 3-10d (0.131" X 3") nails. Strongbacks to be attached to walls at their outer ends or restrained by other means.
 - 6) CAUTION, Do not erect truss backwards.



May 3, 2024

WARNING - Verify design parameters and READ NOTES ON THIS AND INCLUDED MITEK REFERENCE PAGE MII-7473 rev. 1/2/2023 BEFORE USE.
Design valid for use only with MiTek® connectors. This design is based only upon parameters shown, and is for an individual building component, not a truss system. Before use, the building designer must verify the applicability of design parameters and properly incorporate this design into the overall building design. Bracing indicated is to prevent buckling of individual truss web and/or chord members only. Additional temporary and permanent bracing is always required for stability and to prevent collapse with possible personal injury and property damage. For general guidance regarding the fabrication, storage, delivery, erection and bracing of trusses and truss systems, see **ANSI/TPH Quality Criteria and DSB-22** available from Truss Plate Institute (www.tpinst.org) and **BCSI Building Component Safety Information** available from the Structural Building Component Association (www.sbcacomponents.com)



818 Soundside Road
Edenton, NC 27932

Job 24052557	Truss F2	Truss Type Floor	Qty 5	Ply 1	BCTH-25 165332719
-----------------	-------------	---------------------	----------	----------	----------------------

The Building Center, Gastonia, NC - 28052,

8.730 s Apr 25 2024 MiTek Industries, Inc. Thu May 2 14:43:38 2024 Page 1
ID:sWUVkoBcB7eFy0GbrIE06iy7HxI-hAgSMYcZ4idWs0fCc76c1zqH5MBi4YLSyKXmIzKvVj

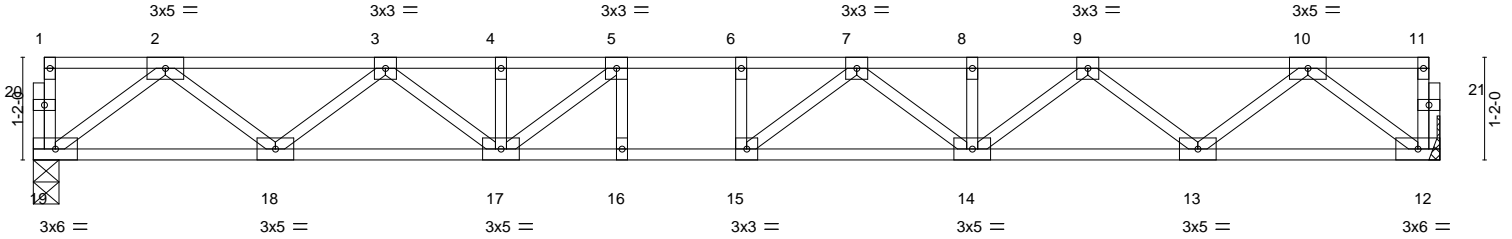
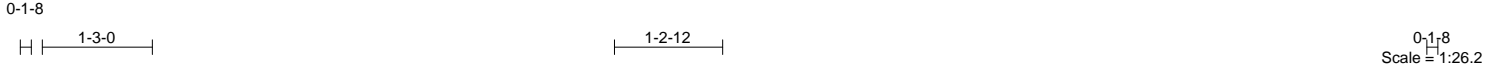

15-11-12
15-11-12

LOADING (psf)	SPACING-	2-0-0	CSI.	DEFL.	in (loc)	l/defl	L/d	PLATES	GRIP
TCLL 40.0	Plate Grip DOL	1.00	TC 0.51	Vert(LL)	-0.22 14-15	>862	360	MT20	244/190
TCDL 10.0	Lumber DOL	1.00	BC 0.98	Vert(CT)	-0.30 14-15	>623	240		
BCLL 0.0	Rep Stress Incr	YES	WB 0.44	Horz(CT)	0.06 12	n/a	n/a		
BCDL 5.0	Code IRC2015/TPI2014		Matrix-S					Weight: 83 lb	FT = 20%F, 11%E

LUMBER-
TOP CHORD 2x4 SP No.2(flat)
BOT CHORD 2x4 SP No.2(flat)
WEBS 2x4 SP No.3(flat)

BRACING-
TOP CHORD Structural wood sheathing directly applied or 6-0-0 oc purlins, except end verticals.
BOT CHORD Rigid ceiling directly applied or 2-2-0 oc bracing.

REACTIONS. (size) 19=0-3-8, 12=Mechanical
Max Grav 19=859(LC 1), 12=859(LC 1)

FORCES. (lb) - Max. Comp./Max. Ten. - All forces 250 (lb) or less except when shown.
TOP CHORD 2-3=-1781/0, 3-4=-2873/0, 4-5=-2873/0, 5-6=-3224/0, 6-7=-3224/0, 7-8=-2886/0, 8-9=-2886/0, 9-10=-1779/0
BOT CHORD 18-19=0/1074, 17-18=0/2451, 16-17=0/3224, 15-16=0/3224, 14-15=0/3164, 13-14=0/2454, 12-13=0/1073
WEBS 2-19=-1344/0, 2-18=0/921, 3-18=-872/0, 3-17=0/538, 5-17=-650/0, 10-12=-1343/0, 10-13=0/919, 9-13=-879/0, 9-14=0/552, 7-14=-355/0, 7-15=-188/378

- NOTES-**
- 1) Unbalanced floor live loads have been considered for this design.
 - 2) All plates are 1.5x3 MT20 unless otherwise indicated.
 - 3) Refer to girder(s) for truss to truss connections.
 - 4) Recommend 2x6 strongbacks, on edge, spaced at 10-0-0 oc and fastened to each truss with 3-10d (0.131" X 3") nails. Strongbacks to be attached to walls at their outer ends or restrained by other means.

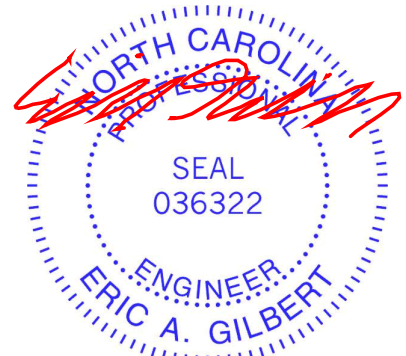

May 3, 2024

WARNING - Verify design parameters and READ NOTES ON THIS AND INCLUDED MITEK REFERENCE PAGE MII-7473 rev. 1/2/2023 BEFORE USE.
Design valid for use only with MiTek® connectors. This design is based only upon parameters shown, and is for an individual building component, not a truss system. Before use, the building designer must verify the applicability of design parameters and properly incorporate this design into the overall building design. Bracing indicated is to prevent buckling of individual truss web and/or chord members only. Additional temporary and permanent bracing is always required for stability and to prevent collapse with possible personal injury and property damage. For general guidance regarding the fabrication, storage, delivery, erection and bracing of trusses and truss systems, see **ANSI/TPH Quality Criteria and DSB-22** available from Truss Plate Institute (www.tpinst.org) and **BCSI Building Component Safety Information** available from the Structural Building Component Association (www.sbcacomponents.com)



818 Soundside Road
Edenton, NC 27932

Job 24052557	Truss F1	Truss Type Floor	Qty 1	Ply 1	BCTH-25 Job Reference (optional)	165332720
-----------------	-------------	---------------------	----------	----------	-------------------------------------	-----------

The Building Center, Gastonia, NC - 28052,

8.730 s Apr 25 2024 MiTek Industries, Inc. Thu May 2 14:43:38 2024 Page 1
ID:sWUVkoBcB7eFy0GbrIE06iy7Hxl-hAgSMYcZ4idWs0fCc76c1zpe5Qyi4SLyKXmIzKvVj

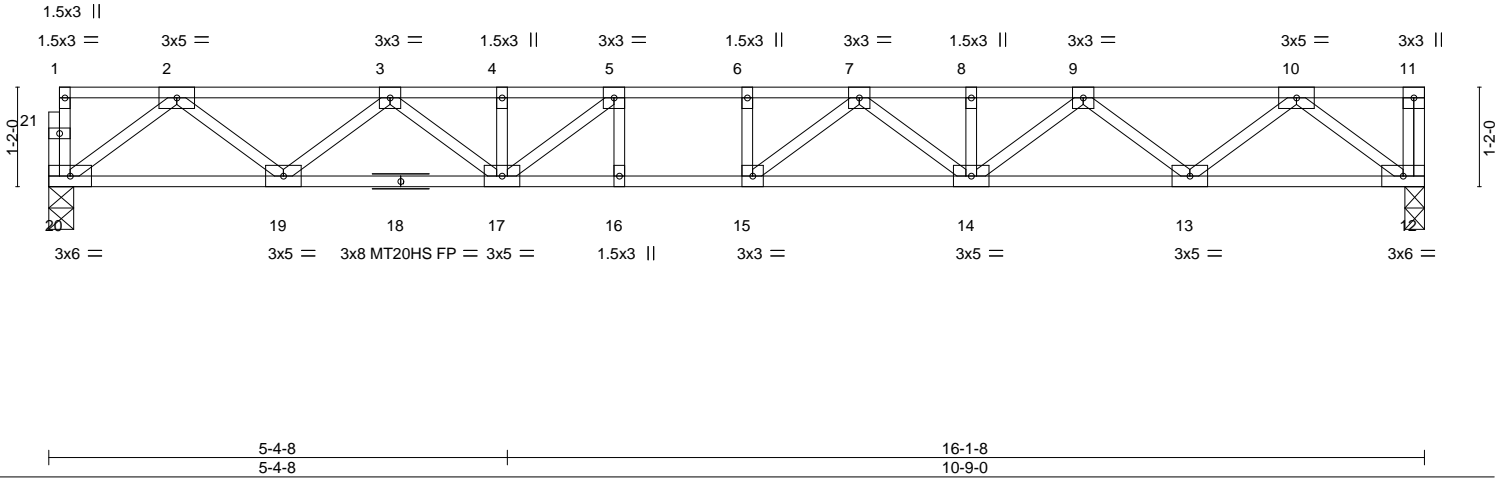
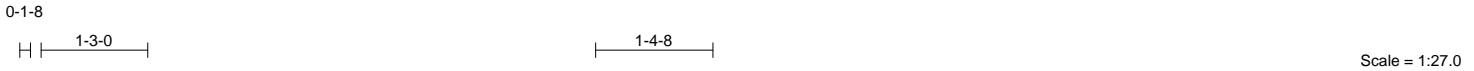

5-4-8		16-1-8		5-4-8		10-9-0			
LOADING (psf)	SPACING-	2-0-0	CSI.	DEFL.	in (loc)	l/defl	L/d	PLATES	GRIP
TCLL 40.0	Plate Grip DOL	1.00	TC 0.55	Vert(LL)	-0.22 14-15	>880	360	MT20	244/190
TCDL 10.0	Lumber DOL	1.00	BC 0.74	Vert(CT)	-0.30 14-15	>636	240	MT20HS	187/143
BCLL 0.0	Rep Stress Incr	YES	WB 0.44	Horz(CT)	0.05 12	n/a	n/a		
BCDL 5.0	Code IRC2015/TPI2014		Matrix-S						
								Weight: 84 lb	FT = 20%F, 11%E

LUMBER-	BRACING-
TOP CHORD 2x4 SP No.2(flat)	TOP CHORD Structural wood sheathing directly applied or 6-0-0 oc purlins, except end verticals.
BOT CHORD 2x4 SP No.2(flat) *Except* 12-18: 2x4 SP No.1(flat)	BOT CHORD Rigid ceiling directly applied or 10-0-0 oc bracing.
WEBS 2x4 SP No.3(flat)	

REACTIONS. (size) 20=0-3-8, 12=0-2-12
Max Grav 20=867(LC 1), 12=873(LC 1)

FORCES. (lb) - Max. Comp./Max. Ten. - All forces 250 (lb) or less except when shown.
TOP CHORD 2-3=-1802/0, 3-4=-2910/0, 4-5=-2910/0, 5-6=-3282/0, 6-7=-3282/0, 7-8=-2926/0,
8-9=-2926/0, 9-10=-1799/0
BOT CHORD 19-20=0/1084, 17-19=0/2481, 16-17=0/3282, 15-16=0/3282, 14-15=0/3214, 13-14=0/2484,
12-13=0/1084
WEBS 2-20=-1358/0, 2-19=0/934, 3-19=-884/0, 3-17=0/548, 10-12=-1360/0, 10-13=0/931,
9-13=-892/0, 9-14=0/564, 7-14=-367/0, 7-15=-181/396, 5-17=-685/0

- NOTES-**
- 1) Unbalanced floor live loads have been considered for this design.
 - 2) All plates are MT20 plates unless otherwise indicated.
 - 3) Provide mechanical connection (by others) of truss to bearing plate at joint(s) 12.
 - 4) Recommend 2x6 strongbacks, on edge, spaced at 10-0-0 oc and fastened to each truss with 3-10d (0.131" X 3") nails.
Strongbacks to be attached to walls at their outer ends or restrained by other means.
 - 5) CAUTION, Do not erect truss backwards.

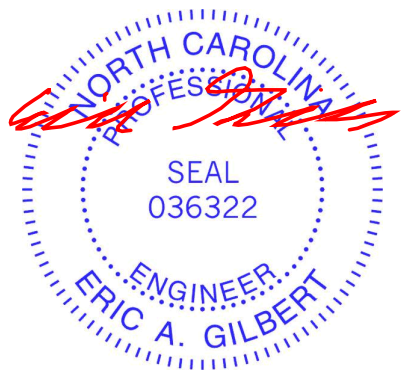

May 3, 2024

Job 24052557	Truss L01	Truss Type GABLE	Qty 1	Ply 1	BCTH-25 Job Reference (optional)	I65332721
-----------------	--------------	---------------------	----------	----------	-------------------------------------	-----------

The Building Center, Gastonia, NC - 28052,

8.730 s Apr 25 2024 MiTek Industries, Inc. Thu May 2 14:43:41 2024 Page 1
ID:sWUVkoBcB7eFy0GbrlE06iy7Hxl-6lLa__a5s?4CNKkEtkgpEgbQDjcxvXfn8vYBz4zKVwG

0-1/8

Scale = 1:26.8

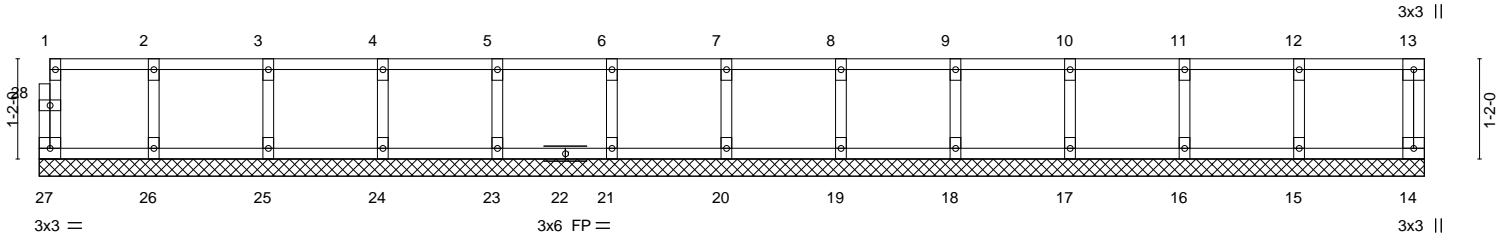

LOADING (psf)	SPACING-	CSI.	DEFL.	in (loc)	l/defl	L/d	PLATES	GRIP
TCLL 40.0	2-0-0	TC 0.08	Vert(LL)	n/a	-	n/a	MT20	244/190
TCDL 10.0	Plate Grip DOL 1.00	BC 0.01	Vert(CT)	n/a	-	n/a		
BCLL 0.0	Lumber DOL 1.00	WB 0.03	Horz(CT)	0.00	14	n/a		
BCDL 5.0	Rep Stress Incr YES	Matrix-R					Weight: 68 lb	FT = 20%F, 11%E
	Code IRC2015/TPI2014							

LUMBER-
TOP CHORD 2x4 SP No.2(flat)
BOT CHORD 2x4 SP No.2(flat)
WEBS 2x4 SP No.3(flat)
OTHERS 2x4 SP No.3(flat)

BRACING-
TOP CHORD Structural wood sheathing directly applied or 6-0-0 oc purlins, except end verticals.
BOT CHORD Rigid ceiling directly applied or 10-0-0 oc bracing.

REACTIONS. All bearings 16-1-8.
(lb) - Max Grav All reactions 250 lb or less at joint(s) 27, 14, 26, 25, 24, 23, 21, 20, 19, 18, 17, 16, 15

FORCES. (lb) - Max. Comp./Max. Ten. - All forces 250 (lb) or less except when shown.

- NOTES-**
- 1) All plates are 1.5x3 MT20 unless otherwise indicated.
 - 2) Gable requires continuous bottom chord bearing.
 - 3) Truss to be fully sheathed from one face or securely braced against lateral movement (i.e. diagonal web).
 - 4) Gable studs spaced at 1-4-0 oc.
 - 5) Recommend 2x6 strongbacks, on edge, spaced at 10-0-0 oc and fastened to each truss with 3-10d (0.131" X 3") nails. Strongbacks to be attached to walls at their outer ends or restrained by other means.
 - 6) CAUTION, Do not erect truss backwards.



May 3, 2024

WARNING - Verify design parameters and READ NOTES ON THIS AND INCLUDED MITEK REFERENCE PAGE MII-7473 rev. 1/2/2023 BEFORE USE.
Design valid for use only with MiTek® connectors. This design is based only upon parameters shown, and is for an individual building component, not a truss system. Before use, the building designer must verify the applicability of design parameters and properly incorporate this design into the overall building design. Bracing indicated is to prevent buckling of individual truss web and/or chord members only. Additional temporary and permanent bracing is always required for stability and to prevent collapse with possible personal injury and property damage. For general guidance regarding the fabrication, storage, delivery, erection and bracing of trusses and truss systems, see **ANSI/TPH Quality Criteria and DSB-22** available from Truss Plate Institute (www.tpinst.org) and **BCSI Building Component Safety Information** available from the Structural Building Component Association (www.sbcacomponents.com)



818 Soundside Road
Edenton, NC 27932

Job 24052557	Truss L03	Truss Type GABLE	Qty 1	Ply 1	BCTH-25 Job Reference (optional)	165332722
-----------------	--------------	---------------------	----------	----------	-------------------------------------	-----------

The Building Center, Gastonia, NC - 28052,

8.730 s Apr 25 2024 MiTek Industries, Inc. Thu May 2 14:43:42 2024 Page 1
ID:sWUVkoBcB7eFy0GbrlE06iy7Hxl-axvzCKbjdJC3_TJRRSB2mt8bxjy2e_vwNZlIVWzKVwF

0-1/8

Scale = 1:29.8

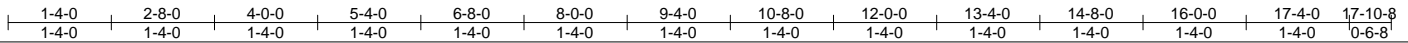
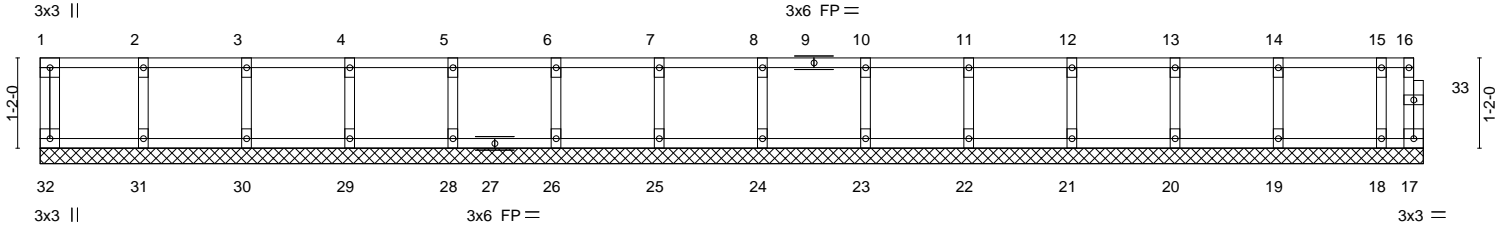

LOADING (psf)	SPACING-	2-0-0	CSI.	DEFL.	in (loc)	l/defl	L/d	PLATES	GRIP	
TCLL 40.0	Plate Grip DOL	1.00	TC 0.08	Vert(LL)	n/a	-	n/a	999	MT20	244/190
TCDL 10.0	Lumber DOL	1.00	BC 0.02	Vert(CT)	n/a	-	n/a	999		
BCLL 0.0	Rep Stress Incr	YES	WB 0.03	Horz(CT)	0.00	17	n/a	n/a		
BCDL 5.0	Code IRC2015/TPI2014		Matrix-R						Weight: 76 lb	FT = 20%F, 11%E

LUMBER-	BRACING-
TOP CHORD 2x4 SP No.2(flat)	TOP CHORD Structural wood sheathing directly applied or 6-0-0 oc purlins, except end verticals.
BOT CHORD 2x4 SP No.2(flat)	BOT CHORD Rigid ceiling directly applied or 10-0-0 oc bracing.
WEBS 2x4 SP No.3(flat)	
OTHERS 2x4 SP No.3(flat)	

REACTIONS. All bearings 17-10-8.
(lb) - Max Grav All reactions 250 lb or less at joint(s) 32, 17, 31, 30, 29, 28, 26, 25, 24, 23, 22, 21, 20, 19, 18

FORCES. (lb) - Max. Comp./Max. Ten. - All forces 250 (lb) or less except when shown.

- NOTES-**
- 1) All plates are 1.5x3 MT20 unless otherwise indicated.
 - 2) Gable requires continuous bottom chord bearing.
 - 3) Truss to be fully sheathed from one face or securely braced against lateral movement (i.e. diagonal web).
 - 4) Gable studs spaced at 1-4-0 oc.
 - 5) Recommend 2x6 strongbacks, on edge, spaced at 10-0-0 oc and fastened to each truss with 3-10d (0.131" X 3") nails. Strongbacks to be attached to walls at their outer ends or restrained by other means.
 - 6) CAUTION, Do not erect truss backwards.



WARNING - Verify design parameters and READ NOTES ON THIS AND INCLUDED MITEK REFERENCE PAGE MII-7473 rev. 1/2/2023 BEFORE USE.
Design valid for use only with MiTek® connectors. This design is based only upon parameters shown, and is for an individual building component, not a truss system. Before use, the building designer must verify the applicability of design parameters and properly incorporate this design into the overall building design. Bracing indicated is to prevent buckling of individual truss web and/or chord members only. Additional temporary and permanent bracing is always required for stability and to prevent collapse with possible personal injury and property damage. For general guidance regarding the fabrication, storage, delivery, erection and bracing of trusses and truss systems, see **ANSI/TPH Quality Criteria and DSB-22** available from Truss Plate Institute (www.tpinst.org) and **BCSI Building Component Safety Information** available from the Structural Building Component Association (www.sbcacomponents.com)



Job 24052557	Truss F6	Truss Type Floor	Qty 6	Ply 1	BCTH-25 Job Reference (optional)	I65332724
-----------------	-------------	---------------------	----------	----------	-------------------------------------	-----------

The Building Center, Gastonia, NC - 28052,

8.730 s Apr 25 2024 MiTek Industries, Inc. Thu May 2 14:43:40 2024 Page 1
ID:sWUVkoBcB7eFy0GbrlE06iy7Hxl-dZnCneZT5iyLIA92J19ahS38xv5MAzxevFpeRdzKVwH

0-1-8

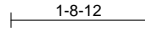
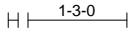

0-1-8
Scale = 1:29.1

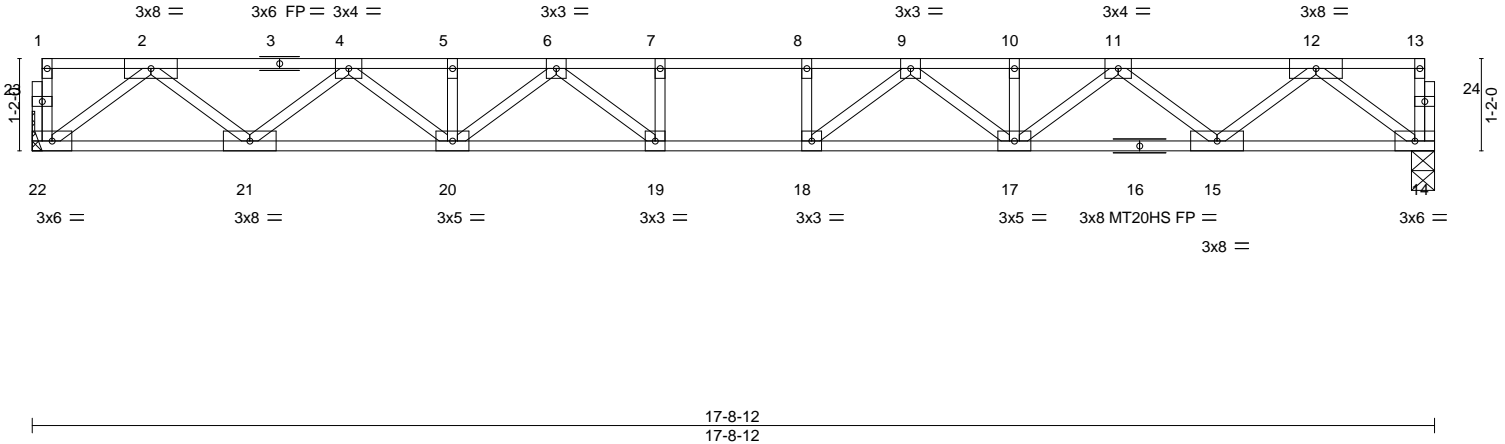

LOADING (psf)	SPACING-	2-0-0	CSI.	DEFL.	in (loc)	l/defl	L/d	PLATES	GRIP
TCLL 40.0	Plate Grip DOL	1.00	TC 0.62	Vert(LL)	-0.29 18-19	>713	360	MT20	244/190
TCDL 10.0	Lumber DOL	1.00	BC 0.80	Vert(CT)	-0.40 18-19	>519	240	MT20HS	187/143
BCLL 0.0	Rep Stress Incr	YES	WB 0.51	Horz(CT)	0.07 14	n/a	n/a		
BCDL 5.0	Code IRC2015/TPI2014		Matrix-S						
								Weight: 90 lb	FT = 20%F, 11%E

LUMBER-

TOP CHORD 2x4 SP No.2(flat)
 BOT CHORD 2x4 SP No.1(flat) *Except*
 14-16: 2x4 SP No.2(flat)
 WEBS 2x4 SP No.3(flat)

BRACING-

TOP CHORD Structural wood sheathing directly applied or 5-8-14 oc purlins, except end verticals.
 BOT CHORD Rigid ceiling directly applied or 10-0-0 oc bracing.

REACTIONS.

(size) 22=Mechanical, 14=0-3-8
 Max Grav 22=955(LC 1), 14=955(LC 1)

FORCES. (lb) - Max. Comp./Max. Ten. - All forces 250 (lb) or less except when shown.

TOP CHORD 2-4=-2021/0, 4-5=-3360/0, 5-6=-3360/0, 6-7=-3993/0, 7-8=-3993/0, 8-9=-3993/0,
 9-10=-3360/0, 10-11=-3360/0, 11-12=-2021/0
 BOT CHORD 21-22=0/1200, 20-21=0/2809, 19-20=0/3760, 18-19=0/3993, 17-18=0/3760, 15-17=0/2809,
 14-15=0/1200
 WEBS 2-22=-1502/0, 2-21=0/1069, 4-21=-1025/0, 4-20=0/704, 12-14=-1502/0, 12-15=0/1070,
 11-15=-1025/0, 11-17=0/704, 9-17=-511/0, 9-18=-83/610, 6-20=-511/0, 6-19=-83/610,
 7-19=-270/0, 8-18=-270/0

NOTES-

- 1) Unbalanced floor live loads have been considered for this design.
- 2) All plates are MT20 plates unless otherwise indicated.
- 3) All plates are 1.5x3 MT20 unless otherwise indicated.
- 4) Refer to girder(s) for truss to truss connections.
- 5) Recommend 2x6 strongbacks, on edge, spaced at 10-0-0 oc and fastened to each truss with 3-10d (0.131" X 3") nails. Strongbacks to be attached to walls at their outer ends or restrained by other means.

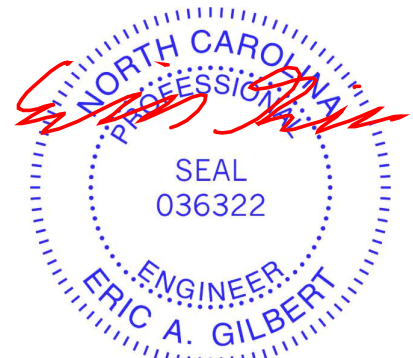

May 3, 2024

WARNING - Verify design parameters and READ NOTES ON THIS AND INCLUDED MITEK REFERENCE PAGE MII-7473 rev. 1/2/2023 BEFORE USE.

Design valid for use only with MiTek® connectors. This design is based only upon parameters shown, and is for an individual building component, not a truss system. Before use, the building designer must verify the applicability of design parameters and properly incorporate this design into the overall building design. Bracing indicated is to prevent buckling of individual truss web and/or chord members only. Additional temporary and permanent bracing is always required for stability and to prevent collapse with possible personal injury and property damage. For general guidance regarding the fabrication, storage, delivery, erection and bracing of trusses and truss systems, see **ANSI/TPH Quality Criteria and DSB-22** available from Truss Plate Institute (www.tpinst.org) and **BCSI Building Component Safety Information** available from the Structural Building Component Association (www.sbcacomponents.com)



818 Soundside Road
 Edenton, NC 27932

Job 24052557	Truss F7	Truss Type Floor	Qty 1	Ply 1	BCTH-25 Job Reference (optional)	I65332725
-----------------	-------------	---------------------	----------	----------	-------------------------------------	-----------

The Building Center, Gastonia, NC - 28052,

8.730 s Apr 25 2024 MiTek Industries, Inc. Thu May 2 14:43:40 2024 Page 1
ID:sWUVkoBcB7eFy0GbrIE06iy7HxI-dZnCneZT5iyLIA92J19ahS39vv4HAyievFpeRdzKVwH

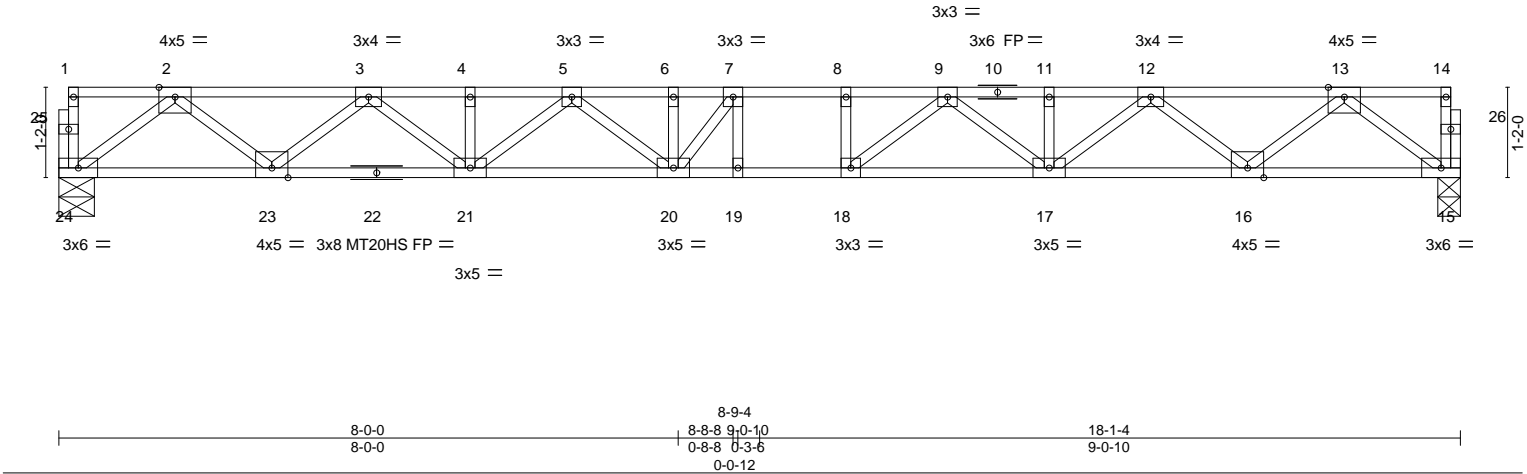
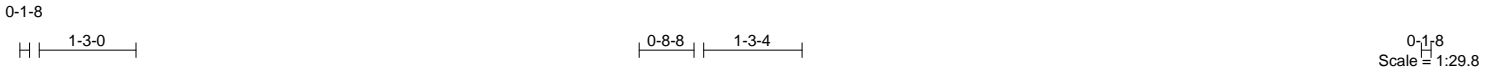

LOADING (psf)	SPACING-	CSI.	DEFL.	in (loc)	l/defl	L/d	PLATES	GRIP
TCLL 40.0	2-0-0	TC 0.56	Vert(LL)	-0.32	19	>659	MT20	244/190
TCDL 10.0	Plate Grip DOL 1.00	BC 0.87	Vert(CT)	-0.45	19	>480	MT20HS	187/143
BCLL 0.0	Lumber DOL 1.00	WB 0.52	Horz(CT)	0.07	15	n/a		
BCDL 5.0	Rep Stress Incr YES	Matrix-S						
	Code IRC2015/TPI2014						Weight: 95 lb	FT = 20%F, 11%E

LUMBER-	BRACING-
TOP CHORD 2x4 SP No.2(flat)	TOP CHORD Structural wood sheathing directly applied or 5-8-1 oc purlins, except end verticals.
BOT CHORD 2x4 SP No.2(flat) *Except* 15-22: 2x4 SP No.1(flat)	BOT CHORD Rigid ceiling directly applied or 10-0-0 oc bracing.
WEBS 2x4 SP No.3(flat)	

REACTIONS. (size) 24=0-5-8, 15=0-3-8
Max Grav 24=976(LC 1), 15=976(LC 1)

FORCES. (lb) - Max. Comp./Max. Ten. - All forces 250 (lb) or less except when shown.
 TOP CHORD 2-3=-2073/0, 3-4=-3461/0, 4-5=-3461/0, 5-6=-4136/0, 6-7=-4136/0, 7-8=-4164/0,
 8-9=-4164/0, 9-11=-3460/0, 11-12=-3460/0, 12-13=-2073/0
 BOT CHORD 23-24=0/1227, 21-23=0/2885, 20-21=0/3892, 19-20=0/4164, 18-19=0/4164, 17-18=0/3891,
 16-17=0/2884, 15-16=0/1227
 WEBS 2-24=-1536/0, 2-23=0/1102, 3-23=-1057/0, 3-21=0/735, 5-21=-551/0, 5-20=0/372,
 13-15=-1537/0, 13-16=0/1102, 12-16=-1055/0, 12-17=0/735, 9-17=-550/0, 9-18=-42/598,
 7-20=-458/324

- NOTES-**
- 1) Unbalanced floor live loads have been considered for this design.
 - 2) All plates are MT20 plates unless otherwise indicated.
 - 3) All plates are 1.5x3 MT20 unless otherwise indicated.
 - 4) Recommend 2x6 strongbacks, on edge, spaced at 10-0-0 oc and fastened to each truss with 3-10d (0.131" X 3") nails. Strongbacks to be attached to walls at their outer ends or restrained by other means.

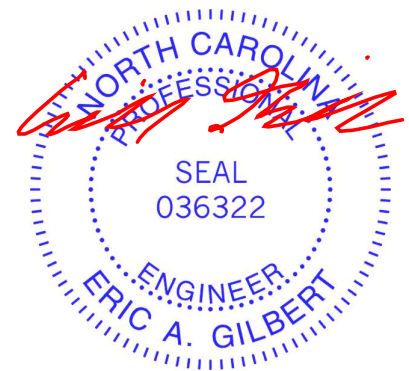

May 3, 2024

Job 24052557	Truss F8	Truss Type Floor Girder	Qty 1	Ply 1	BCTH-25 Job Reference (optional)	165332726
-----------------	-------------	----------------------------	----------	----------	-------------------------------------	-----------

The Building Center, Gastonia, NC - 28052,

8.730 s Apr 25 2024 MiTek Industries, Inc. Thu May 2 14:43:41 2024 Page 1

ID:sWUVkoBcB7eFy0GbrlE06iy7Hxl-6lLa__a5s?4CNKkEtkgpEgblvJQGVsJn8vYBz4zKVwG

1-3-0

1-3-0

0-1-8

Scale = 1:22.3

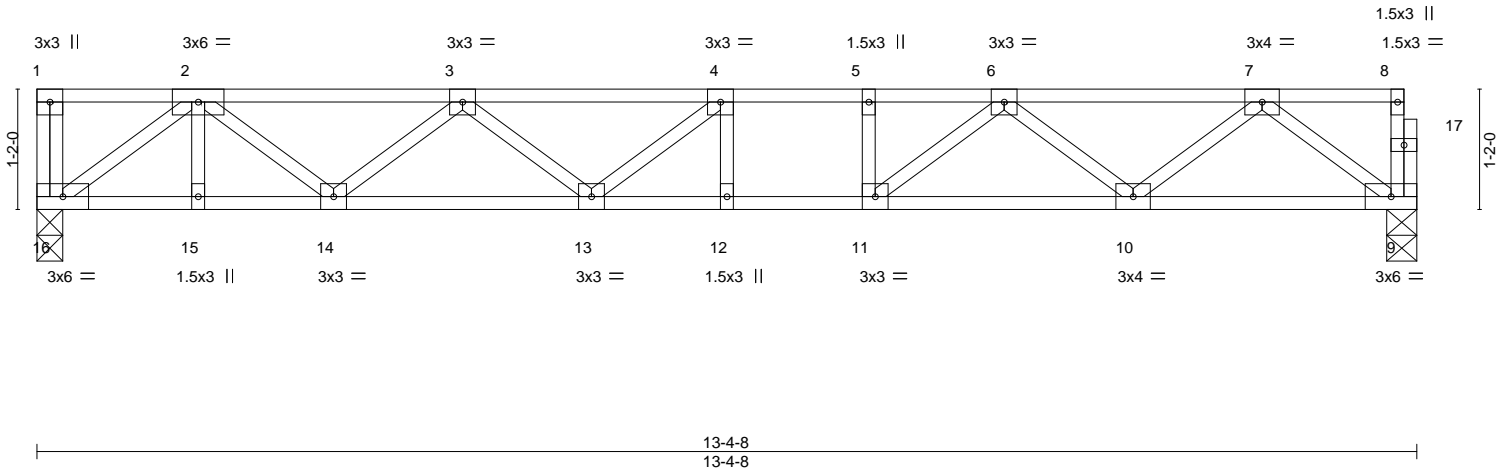

LOADING (psf)	SPACING-	CSI.	DEFL.	in (loc)	l/defl	L/d	PLATES	GRIP
TCLL 40.0	2-0-0	TC 0.61	Vert(LL)	-0.13 12-13	>999	360	MT20	244/190
TCDL 10.0	Plate Grip DOL 1.00	BC 0.83	Vert(CT)	-0.18 12-13	>864	240		
BCLL 0.0	Lumber DOL 1.00	WB 0.37	Horz(CT)	0.03 9	n/a	n/a		
BCDL 5.0	Rep Stress Incr NO	Matrix-S					Weight: 70 lb	FT = 20%F, 11%E
	Code IRC2015/TPI2014							

LUMBER-

TOP CHORD 2x4 SP No.2(flat)
 BOT CHORD 2x4 SP No.1(flat)
 WEBS 2x4 SP No.3(flat)

BRACING-

TOP CHORD Structural wood sheathing directly applied or 6-0-0 oc purlins, except end verticals.
 BOT CHORD Rigid ceiling directly applied or 10-0-0 oc bracing.

REACTIONS.

(size) 16=0-3-0, 9=0-3-8
 Max Grav 16=989(LC 1), 9=749(LC 1)

FORCES. (lb) - Max. Comp./Max. Ten. - All forces 250 (lb) or less except when shown.

TOP CHORD 2-3=-1799/0, 3-4=-2391/0, 4-5=-2418/0, 5-6=-2418/0, 6-7=-1491/0
 BOT CHORD 15-16=0/1284, 14-15=0/1284, 13-14=0/2273, 12-13=0/2418, 11-12=0/2418, 10-11=0/2050, 9-10=0/926
 WEBS 2-16=-1586/0, 2-14=0/658, 3-14=-616/0, 7-9=-1159/0, 7-10=0/735, 6-10=-728/0, 6-11=0/623

NOTES-

- 1) Unbalanced floor live loads have been considered for this design.
- 2) Recommend 2x6 strongbacks, on edge, spaced at 10-0-0 oc and fastened to each truss with 3-10d (0.131" X 3") nails. Strongbacks to be attached to walls at their outer ends or restrained by other means.
- 3) CAUTION, Do not erect truss backwards.
- 4) Hanger(s) or other connection device(s) shall be provided sufficient to support concentrated load(s) 381 lb down at 1-4-12 on top chord. The design/selection of such connection device(s) is the responsibility of others.
- 5) In the LOAD CASE(S) section, loads applied to the face of the truss are noted as front (F) or back (B).

LOAD CASE(S) Standard

- 1) Dead + Floor Live (balanced): Lumber Increase=1.00, Plate Increase=1.00
 Uniform Loads (plf)
 Vert: 9-16=-10, 1-8=-100
 Concentrated Loads (lb)
 Vert: 2=-301(B)



May 3, 2024

WARNING - Verify design parameters and READ NOTES ON THIS AND INCLUDED MITEK REFERENCE PAGE MII-7473 rev. 1/2/2023 BEFORE USE.

Design valid for use only with MiTek® connectors. This design is based only upon parameters shown, and is for an individual building component, not a truss system. Before use, the building designer must verify the applicability of design parameters and properly incorporate this design into the overall building design. Bracing indicated is to prevent buckling of individual truss web and/or chord members only. Additional temporary and permanent bracing is always required for stability and to prevent collapse with possible personal injury and property damage. For general guidance regarding the fabrication, storage, delivery, erection and bracing of trusses and truss systems, see **ANSI/TPH Quality Criteria and DSB-22** available from Truss Plate Institute (www.tpinst.org) and **BCSI Building Component Safety Information** available from the Structural Building Component Association (www.sbcacomponents.com)



818 Soundside Road
 Edenton, NC 27932

Job 24052557	Truss F10	Truss Type Floor Girder	Qty 1	Ply 1	BCTH-25 Job Reference (optional)	I65332727
-----------------	--------------	----------------------------	----------	----------	-------------------------------------	-----------

The Building Center, Gastonia, NC - 28052,

8.730 s Apr 25 2024 MiTek Industries, Inc. Thu May 2 14:43:38 2024 Page 1
ID:SWUVkoBcB7eFy0GbrlE06iy7HxI-hAgSMYcZ4idWs0fCc76c1zvM5YLi8gLSyKXmIzKVwJ

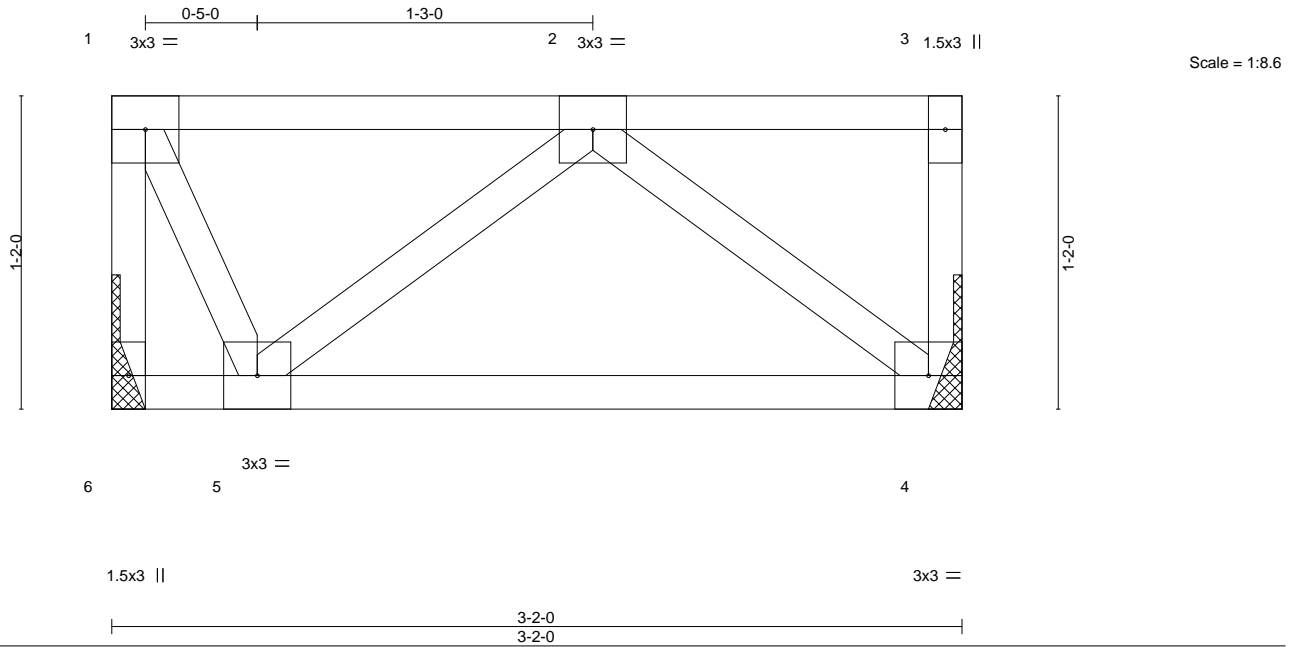

LOADING (psf)	SPACING-	CSI.	DEFL.	in (loc)	l/defl	L/d	PLATES	GRIP
TCLL 40.0	2-0-0	TC 0.18	Vert(LL)	-0.00	5	>999	MT20	244/190
TCDL 10.0	Plate Grip DOL 1.00	BC 0.20	Vert(CT)	-0.01	4-5	>999		
BCLL 0.0	Lumber DOL 1.00	WB 0.17	Horz(CT)	0.00	4	n/a		
BCDL 5.0	Rep Stress Incr NO	Matrix-P					Weight: 18 lb	FT = 20%F, 11%E
	Code IRC2015/TPI2014							

LUMBER-

TOP CHORD 2x4 SP No.2(flat)
BOT CHORD 2x4 SP No.2(flat)
WEBS 2x4 SP No.3(flat)

BRACING-

TOP CHORD Structural wood sheathing directly applied or 3-2-0 oc purlins, except end verticals.
BOT CHORD Rigid ceiling directly applied or 10-0-0 oc bracing.

REACTIONS. (size) 6=Mechanical, 4=Mechanical
Max Grav 6=401(LC 1), 4=475(LC 1)

FORCES. (lb) - Max. Comp./Max. Ten. - All forces 250 (lb) or less except when shown.

TOP CHORD 1-6=-404/0
BOT CHORD 4-5=0/525
WEBS 2-4=-670/0, 2-5=-484/0, 1-5=0/366

NOTES-

- 1) Refer to girder(s) for truss connections.
- 2) Recommend 2x6 strongbacks, on edge, spaced at 10-0-0 oc and fastened to each truss with 3-10d (0.131" X 3") nails. Strongbacks to be attached to walls at their outer ends or restrained by other means.
- 3) Hanger(s) or other connection device(s) shall be provided sufficient to support concentrated load(s) 541 lb down at 1-10-4 on top chord. The design/selection of such connection device(s) is the responsibility of others.
- 4) In the LOAD CASE(S) section, loads applied to the face of the truss are noted as front (F) or back (B).

LOAD CASE(S) Standard

- 1) Dead + Floor Live (balanced): Lumber Increase=1.00, Plate Increase=1.00
Uniform Loads (plf)
Vert: 4-6=-10, 1-3=-100
Concentrated Loads (lb)
Vert: 2=-541(F)

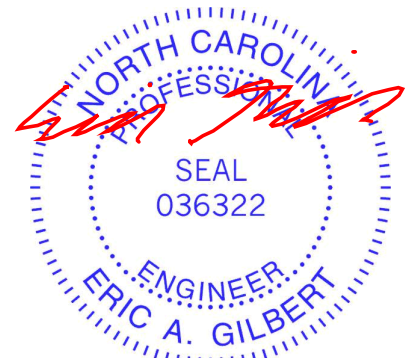

May 3, 2024

WARNING - Verify design parameters and READ NOTES ON THIS AND INCLUDED MITEK REFERENCE PAGE MII-7473 rev. 1/2/2023 BEFORE USE.

Design valid for use only with MiTek® connectors. This design is based only upon parameters shown, and is for an individual building component, not a truss system. Before use, the building designer must verify the applicability of design parameters and properly incorporate this design into the overall building design. Bracing indicated is to prevent buckling of individual truss web and/or chord members only. Additional temporary and permanent bracing is always required for stability and to prevent collapse with possible personal injury and property damage. For general guidance regarding the fabrication, storage, delivery, erection and bracing of trusses and truss systems, see **ANSI/TPH Quality Criteria and DSB-22** available from Truss Plate Institute (www.tpinst.org) and **BCSI Building Component Safety Information** available from the Structural Building Component Association (www.sbcacomponents.com)



818 Soundside Road
Edenton, NC 27932

Job 24052557	Truss L04	Truss Type GABLE	Qty 1	Ply 1	BCTH-25 Job Reference (optional)	I65332728
-----------------	--------------	---------------------	----------	----------	-------------------------------------	-----------

The Building Center, Gastonia, NC - 28052,

8.730 s Apr 25 2024 MiTek Industries, Inc. Thu May 2 14:43:42 2024 Page 1
ID:sWUVkoBcB7eFy0GbrlE06iy7Hxl-axvzCKbjdJC3_TJRRSB2mt8bqjyve_uwNZlIVWzKVwF

0,1-8

Scale = 1:18.4

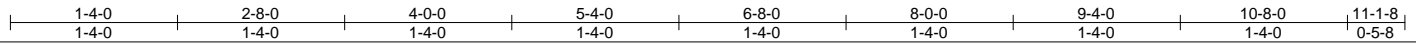
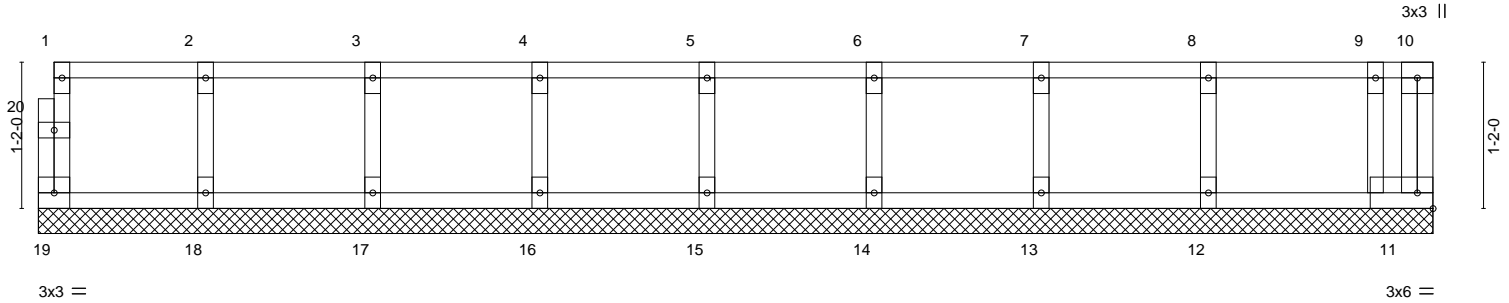

LOADING (psf)	SPACING-	2-0-0	CSI.	DEFL.	in (loc)	l/defl	L/d	PLATES	GRIP	
TCLL 40.0	Plate Grip DOL	1.00	TC 0.09	Vert(LL)	n/a	-	n/a	999	MT20	244/190
TCDL 10.0	Lumber DOL	1.00	BC 0.03	Vert(CT)	n/a	-	n/a	999		
BCLL 0.0	Rep Stress Incr	YES	WB 0.03	Horz(CT)	0.00	11	n/a	n/a		
BCDL 5.0	Code IRC2015/TPI2014		Matrix-R							
									Weight: 49 lb	FT = 20%F, 11%E

LUMBER-
TOP CHORD 2x4 SP No.2(flat)
BOT CHORD 2x4 SP No.2(flat)
WEBS 2x4 SP No.3(flat)
OTHERS 2x4 SP No.3(flat)

BRACING-
TOP CHORD Structural wood sheathing directly applied or 6-0-0 oc purlins, except end verticals.
BOT CHORD Rigid ceiling directly applied or 10-0-0 oc bracing.

REACTIONS. All bearings 11-1-8.
(lb) - Max Grav All reactions 250 lb or less at joint(s) 19, 11, 18, 17, 16, 15, 14, 13, 12

FORCES. (lb) - Max. Comp./Max. Ten. - All forces 250 (lb) or less except when shown.

NOTES-

- 1) All plates are 1.5x3 MT20 unless otherwise indicated.
- 2) Gable requires continuous bottom chord bearing.
- 3) Truss to be fully sheathed from one face or securely braced against lateral movement (i.e. diagonal web).
- 4) Gable studs spaced at 1-4-0 oc.
- 5) Recommend 2x6 strongbacks, on edge, spaced at 10-0-0 oc and fastened to each truss with 3-10d (0.131" X 3") nails. Strongbacks to be attached to walls at their outer ends or restrained by other means.
- 6) CAUTION, Do not erect truss backwards.

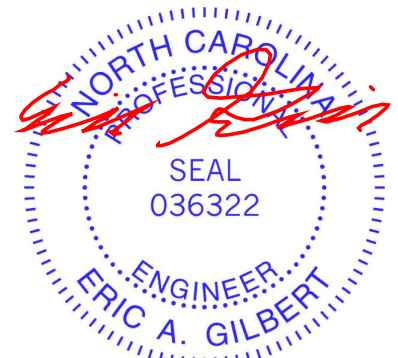

May 3, 2024

WARNING - Verify design parameters and READ NOTES ON THIS AND INCLUDED MITEK REFERENCE PAGE MII-7473 rev. 1/2/2023 BEFORE USE.

Design valid for use only with MiTek® connectors. This design is based only upon parameters shown, and is for an individual building component, not a truss system. Before use, the building designer must verify the applicability of design parameters and properly incorporate this design into the overall building design. Bracing indicated is to prevent buckling of individual truss web and/or chord members only. Additional temporary and permanent bracing is always required for stability and to prevent collapse with possible personal injury and property damage. For general guidance regarding the fabrication, storage, delivery, erection and bracing of trusses and truss systems, see **ANSI/TPI1 Quality Criteria and DSB-22** available from Truss Plate Institute (www.tpinst.org) and **BCSI Building Component Safety Information** available from the Structural Building Component Association (www.sbcacomponents.com)



818 Soundside Road
Edenton, NC 27932

Job 24052557	Truss F9	Truss Type Floor	Qty 1	Ply 1	BCTH-25 Job Reference (optional)	I65332729
-----------------	-------------	---------------------	----------	----------	-------------------------------------	-----------

The Building Center, Gastonia, NC - 28052,

8.730 s Apr 25 2024 MiTek Industries, Inc. Thu May 2 14:43:41 2024 Page 1
ID:sWUVkoBcB7eFy0GbrlE06iy7Hxl-6lLa__a5s?4CNKkEtkgpEgbN7JVLvTrn8vYBz4zKVwG

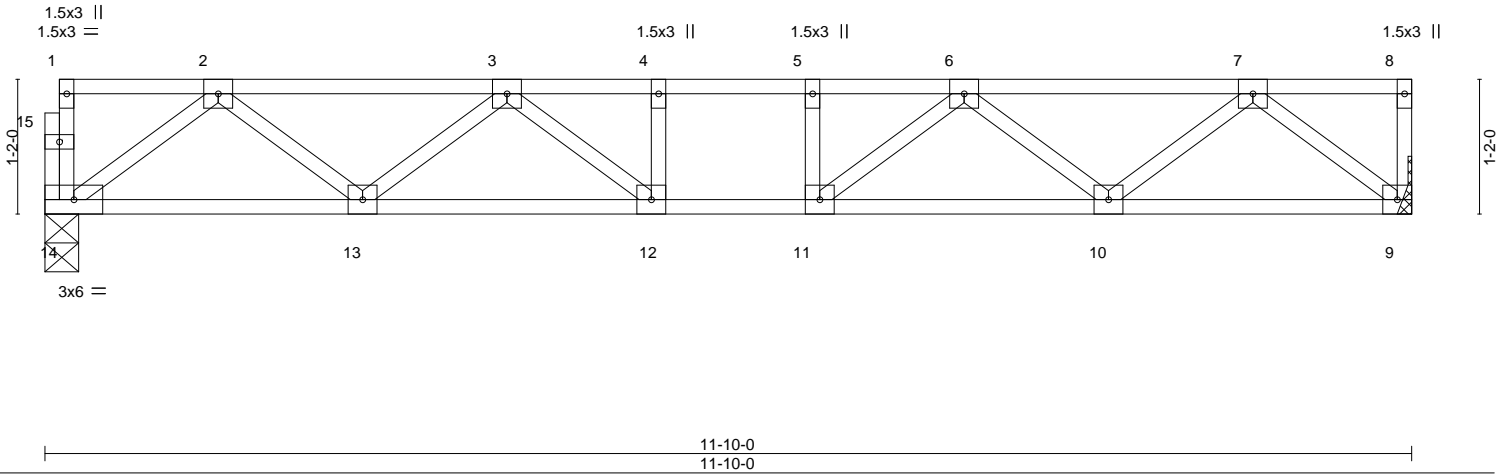
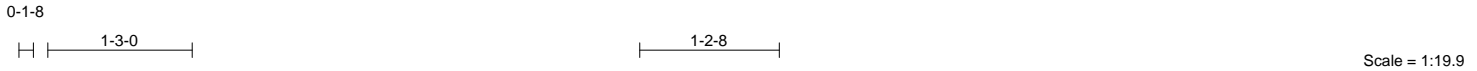

LOADING (psf)	SPACING-	CSI.	DEFL.	in (loc)	l/defl	L/d	PLATES	GRIP
TCLL 40.0	2-0-0	TC 0.28	Vert(LL)	-0.07	12	>999	MT20	244/190
TCDL 10.0	Plate Grip DOL 1.00	BC 0.50	Vert(CT)	-0.09	12	>999		
BCLL 0.0	Lumber DOL 1.00	WB 0.28	Horz(CT)	0.02	9	n/a		
BCDL 5.0	Rep Stress Incr YES	Matrix-S						
	Code IRC2015/TPI2014						Weight: 60 lb	FT = 20%F, 11%E

LUMBER-
 TOP CHORD 2x4 SP No.2(flat)
 BOT CHORD 2x4 SP No.2(flat)
 WEBS 2x4 SP No.3(flat)

BRACING-
 TOP CHORD Structural wood sheathing directly applied or 6-0-0 oc purlins, except end verticals.
 BOT CHORD Rigid ceiling directly applied or 10-0-0 oc bracing.

REACTIONS. (size) 14=0-3-8, 9=Mechanical
 Max Grav 14=634(LC 1), 9=641(LC 1)

FORCES. (lb) - Max. Comp./Max. Ten. - All forces 250 (lb) or less except when shown.
 TOP CHORD 2-3=-1217/0, 3-4=-1769/0, 4-5=-1769/0, 5-6=-1769/0, 6-7=-1195/0
 BOT CHORD 13-14=0/779, 12-13=0/1619, 11-12=0/1769, 10-11=0/1606, 9-10=0/750
 WEBS 2-14=-975/0, 2-13=0/570, 3-13=-523/0, 3-12=-24/370, 7-9=-958/0, 7-10=0/580, 6-10=-535/0, 6-11=-13/381

- NOTES-**
- 1) Unbalanced floor live loads have been considered for this design.
 - 2) All plates are 3x3 MT20 unless otherwise indicated.
 - 3) Refer to girder(s) for truss to truss connections.
 - 4) Recommend 2x6 strongbacks, on edge, spaced at 10-0-0 oc and fastened to each truss with 3-10d (0.131" X 3") nails. Strongbacks to be attached to walls at their outer ends or restrained by other means.
 - 5) CAUTION, Do not erect truss backwards.

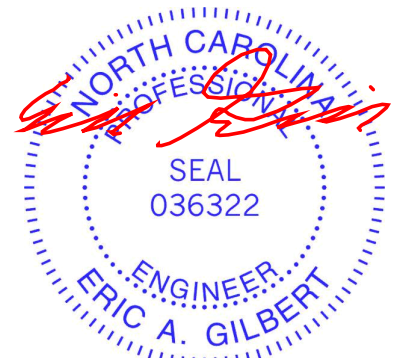

May 3, 2024

WARNING - Verify design parameters and READ NOTES ON THIS AND INCLUDED MITEK REFERENCE PAGE MII-7473 rev. 1/2/2023 BEFORE USE.
 Design valid for use only with MiTek® connectors. This design is based only upon parameters shown, and is for an individual building component, not a truss system. Before use, the building designer must verify the applicability of design parameters and properly incorporate this design into the overall building design. Bracing indicated is to prevent buckling of individual truss web and/or chord members only. Additional temporary and permanent bracing is always required for stability and to prevent collapse with possible personal injury and property damage. For general guidance regarding the fabrication, storage, delivery, erection and bracing of trusses and truss systems, see **ANSI/TPH Quality Criteria and DSB-22** available from Truss Plate Institute (www.tpinst.org) and **BCSI Building Component Safety Information** available from the Structural Building Component Association (www.sbcacomponents.com)



818 Soundside Road
 Edenton, NC 27932

Job 24052557	Truss L05	Truss Type GABLE	Qty 1	Ply 1	BCTH-25 Job Reference (optional)	165332730
-----------------	--------------	---------------------	----------	----------	-------------------------------------	-----------

The Building Center, Gastonia, NC - 28052,

8.730 s Apr 25 2024 MiTek Industries, Inc. Thu May 2 14:43:43 2024 Page 1
ID:sWUVkoBcB7eFy0GbrlE06iy7Hxl-28TLPgclOdkwcdud?9iHJ5gmg6iINR84bD111yzKVwE

0-1-8

Scale = 1:8.9

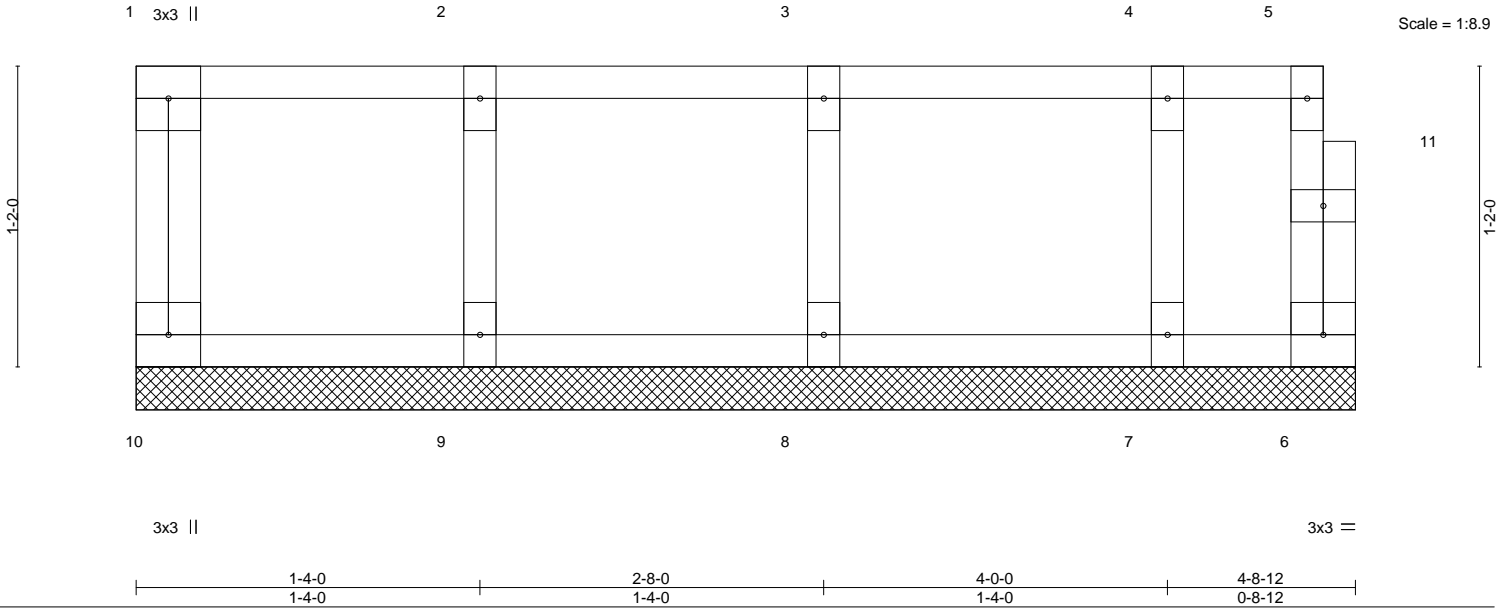

LOADING (psf)	SPACING-	CSL.	DEFL.	in (loc)	l/defl	L/d	PLATES	GRIP
TCLL 40.0	2-0-0	TC 0.08	Vert(LL)	n/a	-	n/a	MT20	244/190
TCDL 10.0	Plate Grip DOL 1.00	BC 0.02	Vert(CT)	n/a	-	n/a		
BCLL 0.0	Lumber DOL 1.00	WB 0.03	Horz(CT)	0.00	6	n/a		
BCDL 5.0	Rep Stress Incr YES	Matrix-R						
	Code IRC2015/TPI2014						Weight: 23 lb	FT = 20%F, 11%E

LUMBER-

TOP CHORD 2x4 SP No.2(flat)
BOT CHORD 2x4 SP No.2(flat)
WEBS 2x4 SP No.3(flat)
OTHERS 2x4 SP No.3(flat)

BRACING-

TOP CHORD Structural wood sheathing directly applied or 4-8-12 oc purlins, except end verticals.
BOT CHORD Rigid ceiling directly applied or 10-0-0 oc bracing.

REACTIONS.

All bearings 4-8-12.

(lb) - Max Grav All reactions 250 lb or less at joint(s) 10, 6, 9, 8, 7

FORCES. (lb) - Max. Comp./Max. Ten. - All forces 250 (lb) or less except when shown.

NOTES-

- All plates are 1.5x3 MT20 unless otherwise indicated.
- Gable requires continuous bottom chord bearing.
- Truss to be fully sheathed from one face or securely braced against lateral movement (i.e. diagonal web).
- Gable studs spaced at 1-4-0 oc.
- Recommend 2x6 strongbacks, on edge, spaced at 10-0-0 oc and fastened to each truss with 3-10d (0.131" X 3") nails. Strongbacks to be attached to walls at their outer ends or restrained by other means.
- CAUTION, Do not erect truss backwards.

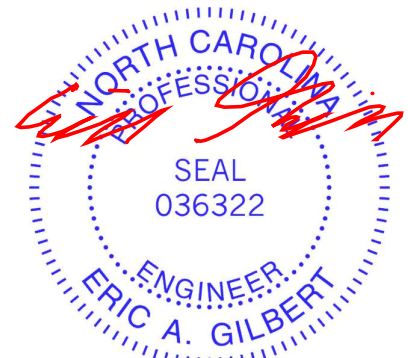

May 3, 2024

WARNING - Verify design parameters and READ NOTES ON THIS AND INCLUDED MITEK REFERENCE PAGE MII-7473 rev. 1/2/2023 BEFORE USE.

Design valid for use only with MiTek® connectors. This design is based only upon parameters shown, and is for an individual building component, not a truss system. Before use, the building designer must verify the applicability of design parameters and properly incorporate this design into the overall building design. Bracing indicated is to prevent buckling of individual truss web and/or chord members only. Additional temporary and permanent bracing is always required for stability and to prevent collapse with possible personal injury and property damage. For general guidance regarding the fabrication, storage, delivery, erection and bracing of trusses and truss systems, see **ANSI/TP1 Quality Criteria and DSB-22** available from Truss Plate Institute (www.tpinst.org) and **BCSI Building Component Safety Information** available from the Structural Building Component Association (www.sbcacomponents.com)



818 Soundside Road
Edenton, NC 27932

Symbols

PLATE LOCATION AND ORIENTATION

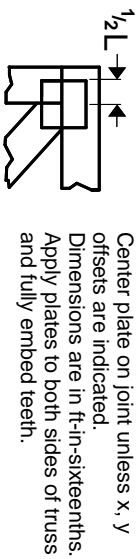

Center plate on joint unless x, y offsets are indicated. Dimensions are in ft-in-sixteenths. Apply plates to both sides of truss and fully embed teeth.

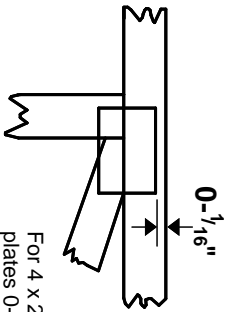

For 4 x 2 orientation, locate plates 0- 1/16" from outside edge of truss.

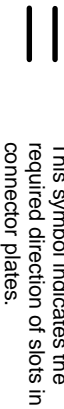

This symbol indicates the required direction of slots in connector plates.

* Plate location details available in MITek software or upon request.

PLATE SIZE

4 X 4

The first dimension is the plate width measured perpendicular to slots. Second dimension is the length parallel to slots.

LATERAL BRACING LOCATION



Indicated by symbol shown and/or by text in the bracing section of the output. Use T or I bracing if indicated.

BEARING

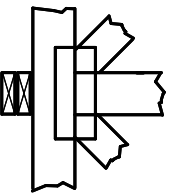

Indicates location where bearings (supports) occur. Icons vary but reaction section indicates joint number/letter where bearings occur. Min size shown is for crushing only.

Industry Standards:

ANSI/TP1: National Design Specification for Metal Plate Connected Wood Truss Construction.
DSB-22: Design Standard for Bracing.
BCSI: Building Component Safety Information, Guide to Good Practice for Handling, Installing, Restraining & Bracing of Metal Plate Connected Wood Trusses.

Numbering System



1 TOP CHORDS
2 Joint ID typ.

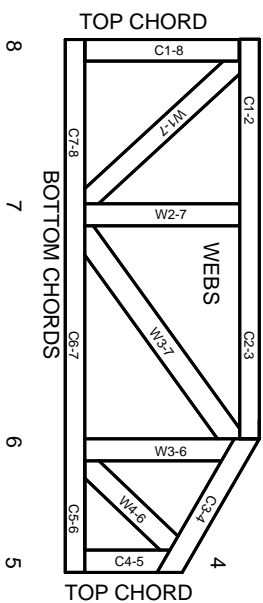

JOINTS ARE GENERALLY NUMBERED/LETTERED CLOCKWISE AROUND THE TRUSS STARTING AT THE JOINT FARTHEST TO THE LEFT.

CHORDS AND WEBS ARE IDENTIFIED BY END JOINT NUMBERS/LETTERS.

Product Code Approvals

ICC-ES Reports:

ESR-1988, ESR-2362, ESR-2685, ESR-3282
ESR-4722, ESL-1388

Design General Notes

Trusses are designed for wind loads in the plane of the truss unless otherwise shown.

Lumber design values are in accordance with ANSI/TP1 section 6.3. These truss designs rely on Lumber values established by others.

© 2023 MITek® All Rights Reserved

MITek

ENGINEERING BY
TRENGO
A MITek Affiliate

MITek Engineering Reference Sheet: MIL-7473 rev. 1/2/2023

General Safety Notes

Failure to Follow Could Cause Property Damage or Personal Injury

1. Additional stability/bracing for truss system, e.g. diagonal or X-bracing, is always required. See BCSI.
2. Truss bracing must be designed by an engineer. For wide truss spacing, individual lateral braces themselves may require bracing, or alternative Tor I bracing should be considered.
3. Never exceed the design loading shown and never stack materials on inadequately braced trusses.
4. Provide copies of this truss design to the building designer, erection supervisor, property owner and all other interested parties.
5. Cut members to bear tightly against each other.
6. Place plates on each face of truss at each joint and embed fully. Knots and wane at joint locations are regulated by ANSI/TP1 1.
7. Design assumes trusses will be suitably protected from the environment in accord with ANSI/TP1 1.
8. Unless otherwise noted, moisture content of lumber shall not exceed 19% at time of fabrication.
9. Unless expressly noted, this design is not applicable for use with fire retardant, preservative treated, or green lumber.
10. Camber is a non-structural consideration and is the responsibility of truss fabricator. General practice is to camber for dead load deflection.
11. Plate type, size, orientation and location dimensions indicated are minimum plating requirements.
12. Lumber used shall be of the species and size, and in all respects, equal to or better than that specified.
13. Top chords must be sheathed or purlins provided at spacing indicated on design.
14. Bottom chords require lateral bracing at 10 ft. spacing, or less, if no ceiling is installed, unless otherwise noted.
15. Connections not shown are the responsibility of others.
16. Do not cut or alter truss member or plate without prior approval of an engineer.
17. Install and load vertically unless indicated otherwise.
18. Use of green or treated lumber may pose unacceptable environmental, health or performance risks. Consult with project engineer before use.
19. Review all portions of this design (front, back, words and pictures) before use. Reviewing pictures alone is not sufficient.
20. Design assumes manufacture in accordance with ANSI/TP1 1 Quality Criteria.
21. The design does not take into account any dynamic or other loads other than those expressly stated.