



**Scope of Work for:
56 Turtle Point Dr
Fuquay-Varina NC 27526**

The following will be performed as crawlspace closed encapsulation:

- *All Vents will be sealed from inside the crawl space with R-10 Rigid 2” Foam Sheathing.
- *Wrap all existing CMU/Brick Piers 20 ml Vapor Barrier. Contractor will leave a termite inspection gap at the top of each pier. The liner will be fastened to the pier and the top edge of the liner will be sealed with caulking.
- *20 ml Vapor Barrier installed wall to wall with 100% floor coverage. All sections of liner will be overlapped a minimum of 1' and will be seamed together, attached with Christmas Tree fasteners, and caulked.
- *R-19 Insulation installed in the rim joist cavities.
- *R-10 Rigid 2” Foam Sheathing - Wall Insulation installed with a 3-4” termite inspection reveal left at the top of the foundation wall. All vents will be sealed from the inside.
- *AprilAire E100 Dehumidifier install - unit specifications on page 2 - using existing electrical

TARHEEL™

BASEMENT SYSTEMS





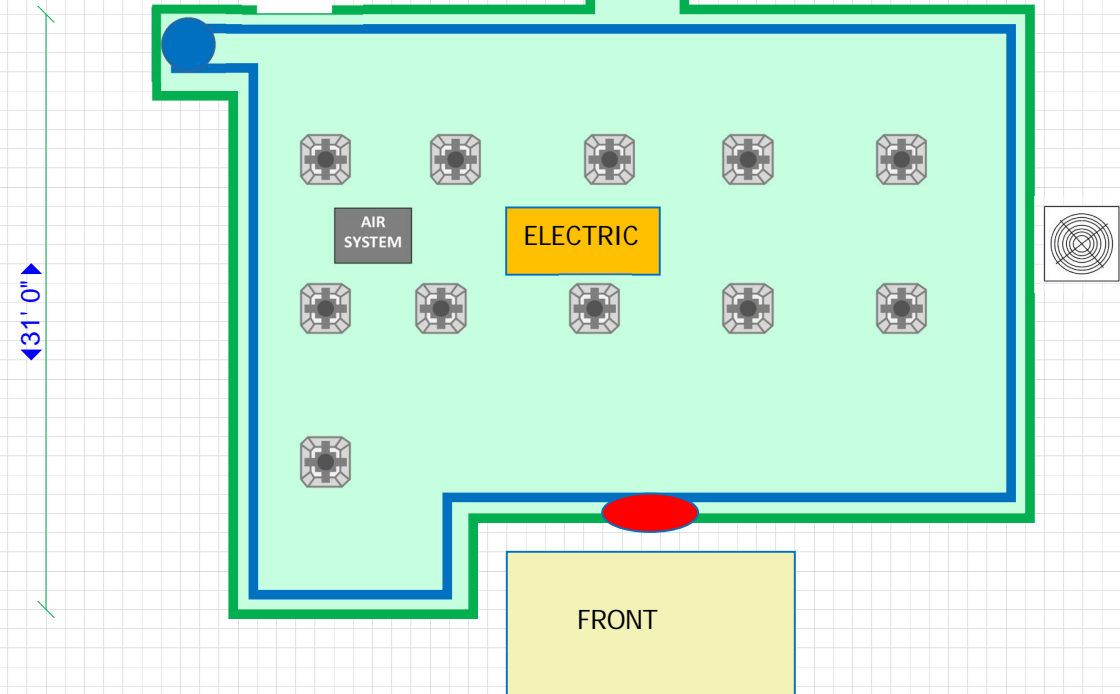

A Groundworks Company

SPECIFICATIONS		
Capacity		
	@ 80°F/60% RH	100 ppd
	@ 73°F/60% RH	85 ppd
Energy Factor		
	@ 80°F/60% RH	2.6 L/kW-h
	@ 73°F/60% RH	2.35 L/kW-h
Airflow @ varying E.S.P. (external static pressure - dry coil)		
	0.0" w.c.	280 CFM
	0.2" w.c.	245 CFM
	0.4" w.c.	210 CFM
Voltage, phase, frequency		120VAC, 1 phase, 60 Hz
Current draw⁽¹⁾		6.9 Amps
Noise		55 dBA ducted
Dimensions: (cabinet only)⁽²⁾		Width: 14" Height: 15" Length: 26"
Unit Weight		64 lbs.
Shipping Weight		82 lbs.
Inlet air operating conditions during		
-Dehumidification:	50°F-104°F, 40°F dew point min.	
-Ventilation:	40°F-140°F, 0%-99% RH (non-condensing)	
<small>⁽¹⁾Rated capacity, energy factor and current draw measured at 80°F/60% RH inlet air at 0.0 ESP.</small>		
<small>⁽²⁾Height does not include adjustable feet. The width excludes the filter doors and length excludes the duct collars.</small>		

CRAWL DOOR
38.5 X 31.5

41' 0"



-  PUMP SINGLE
-  CRAWL DRAIN
152'
-  20 MIL
1135
-  X BLOCK
456
-  AIR SYSTEM
-  FALSE WALL
2
-  VENTS 14
PIERS 11

Site:	Customer Address	Drawing:	801506	Project:	0000416	Drawn:	Tim Tracy	Notes:	Groundworks 1741 Corp Landing Virginia Beach, VA 23454
Title:	Customer Name	Scale:	1/8":1'0"	Date:	01/30/2017	Rev:	A		