

NC Shed Builders
 12x16 Statesman
 Gary Nolder
 62 Waterville Way
 Fuqua Varina, NC 27526

- *Building will sit on concrete blocks used for leveling.
- *Building Will anchored to ground using earth anchors
- *Hurricane clips on rafters and H- Clips

Drawn by: Jennifer Jackson

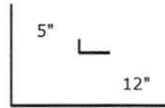
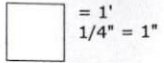

5/12 Roof Pitch
 3-Tab Shingles
 #15 felt roofing paper

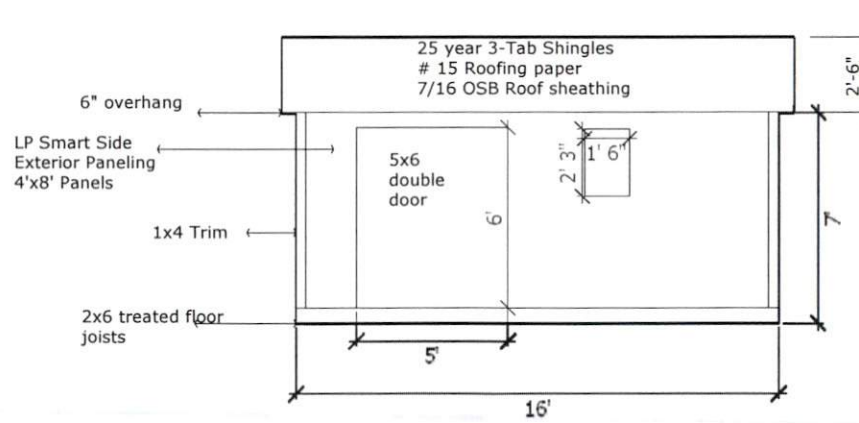
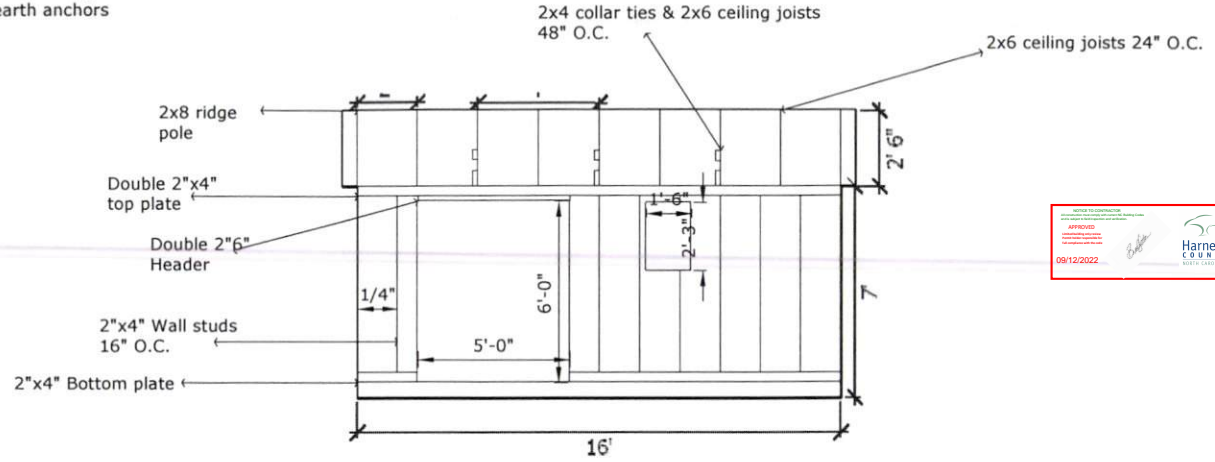

NC Shed Builders
 12x16 Statesman
 Gary Nolder
 62 Waterville Way
 Fuqua Varina, NC 27526

Drawn by: Jennifer Jackson

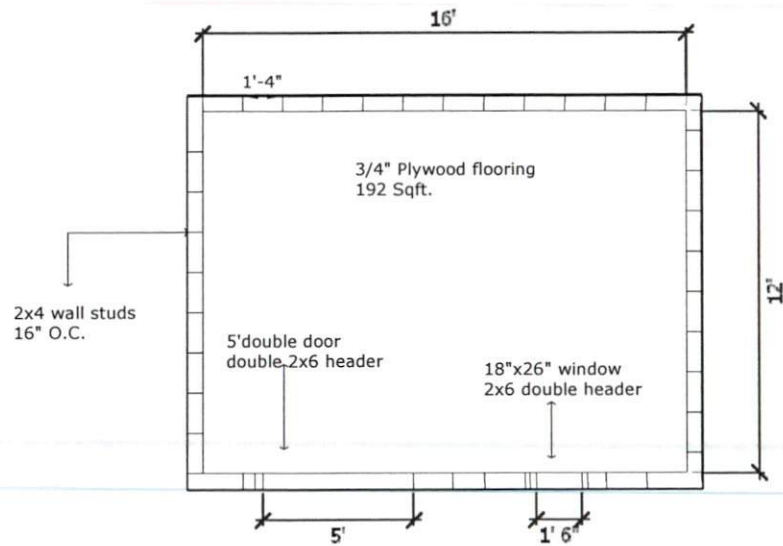
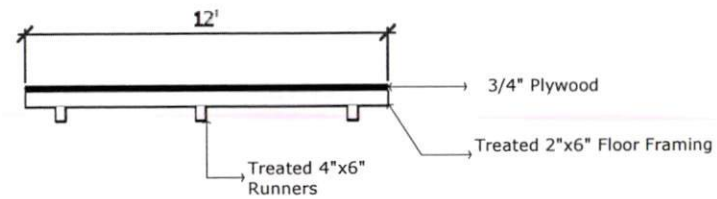
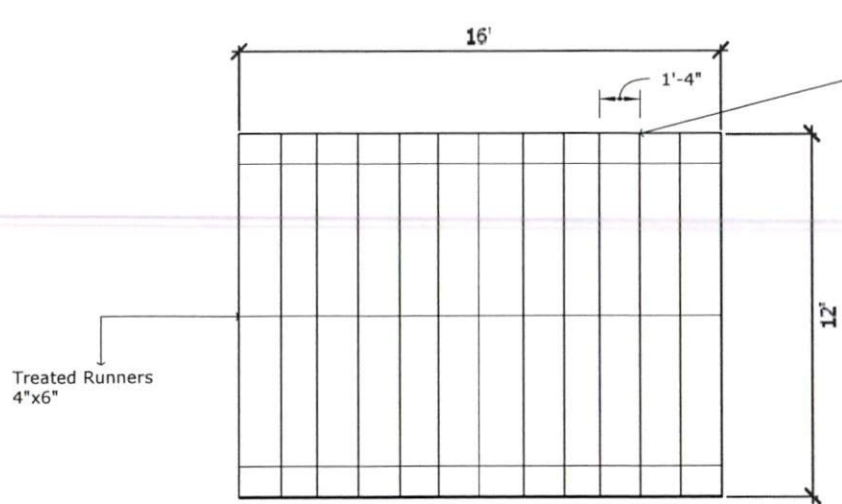
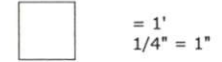

- *Building will sit on concrete blocks used for leveling.
- *Building Will anchored to ground using earth anchors
- *Hurricane clips on rafters and H- Clips