

# Front Deck

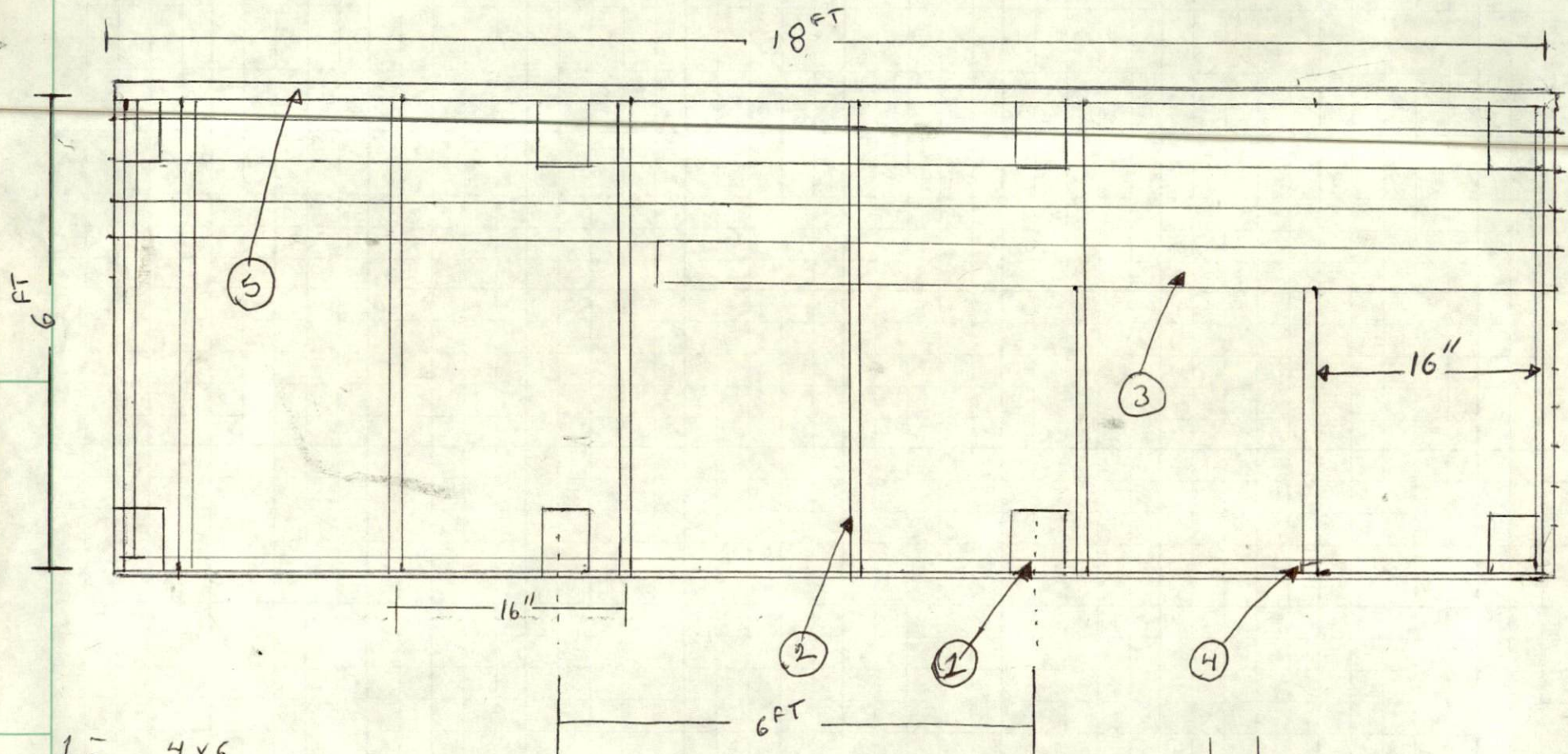

- 1- 4x6
- 2- 2x8
- 3- 1x6
- 4- LUS 28Z 2x8
- 5- 2x10
- 6- Concrete

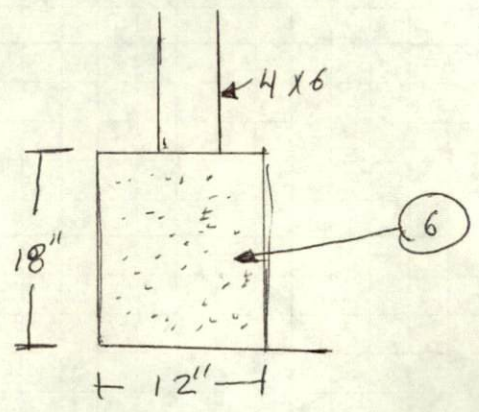

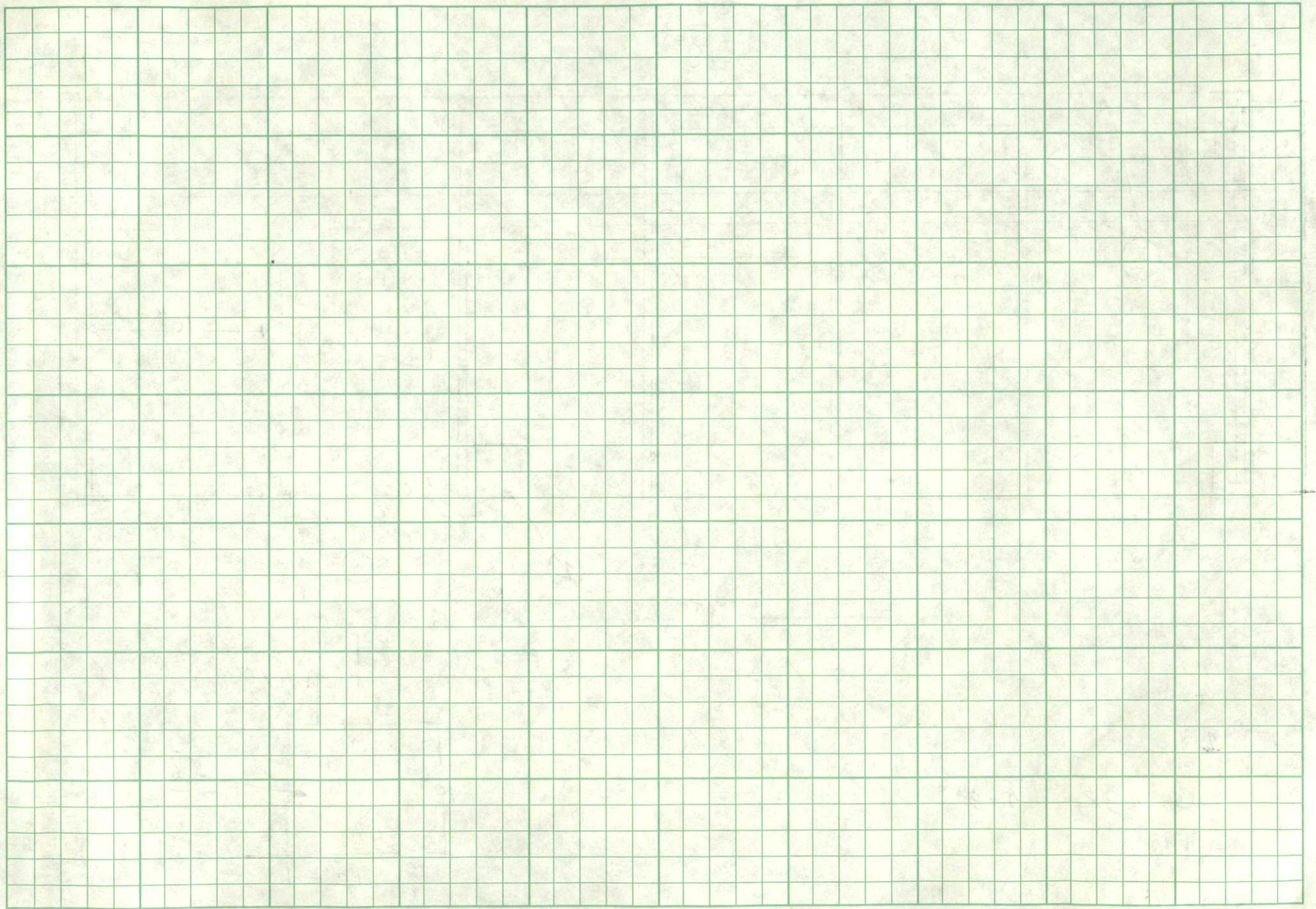

- 6 SCREWS 2 1/2
- 5 Hex bolts Galvanized
- 4 2 X 4
- 3 2 X 4
- 2 2 X 2
- 1 4 X 4

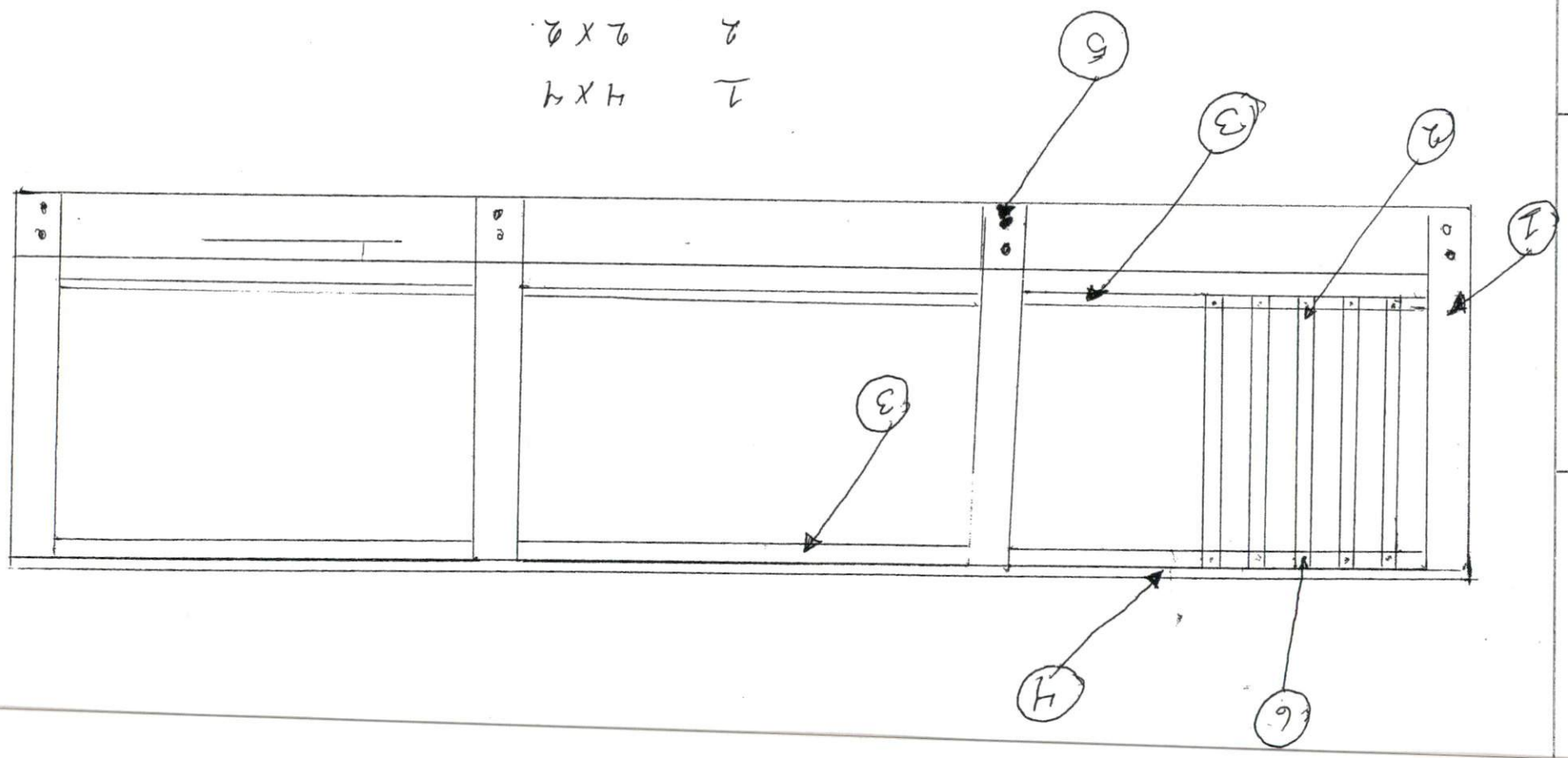

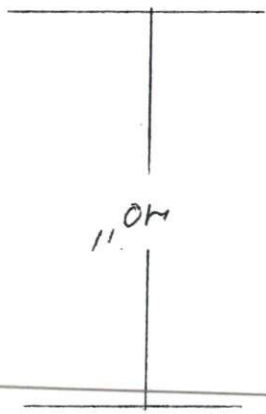

11'0"

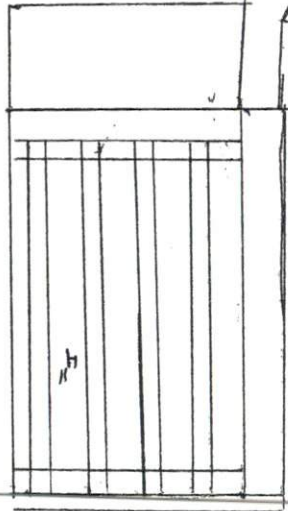

11'4"

12"

11'9"

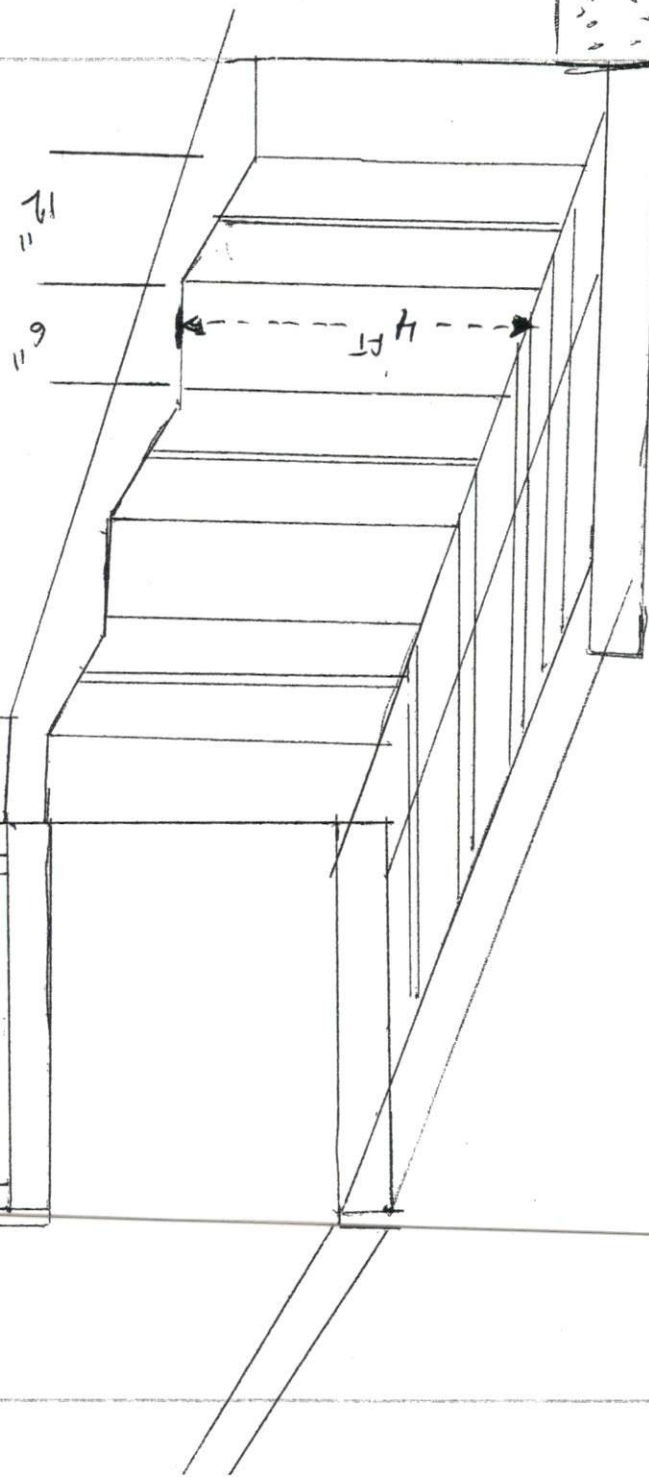

4'5"



11'8"