

EZ-Fit Sheds Instruction Manual

Thank-you for purchasing an EZ-Fit Shed! Our goal is to provide you with everything you need to make the assembly of your shed kit go smoothly.

This instruction manual is based on a 10x14' "Riverside" style building.

Your shed kit may be a different size or style - if this is the case you may have a different amount of wall panels and roof sheathing, however the same assembly principals apply.

There is paperwork included with your packing slip that shows the details on the wall panels and roof sheathing included for your particular shed kit.

Heritage, Homestead and Riverside sheds all have the same roof design. If you purchased the Cornerstone shed, refer to the manual with photos for more details on the roof design.

Also, this manual includes assembly instructions for the optional floor kit. If you purchased your own flooring materials elsewhere, you may refer to this section for tips on assembly. If you are using concrete for your floor, simply disregard this part of the instructions.

Following is a list of which fasteners get used where. Again, refer to the packing slip for a list of fasteners that were sent with your shed kit.

2" Nails:

Fastening 3/4" plywood flooring to floor joists (optional floor kit.)

Corner trim

Roof sheathing

Roof gussets

Fastening Smartside Soffit to sidewalls

Fastening rafters to soffit

Facia trim

Windows and window trim.

2.5" Square-Drive Screws:

Fastening wall panels together

Double 2x4" top/plates

Fastening bottom/plate of walls down into floor. (once building is assembled)

1.5" Screws: for door hardware

Tools Needed:

- Cordless Drill
- Tape Measure
- Step-ladder
- Skilsaw
- Chalkline
- Speed Square
- Level
- Hammer



Floor Construction

Top View of floor framing

To make that floor is square:
 Measure diagonally across corners
 and make that both measurements are same.

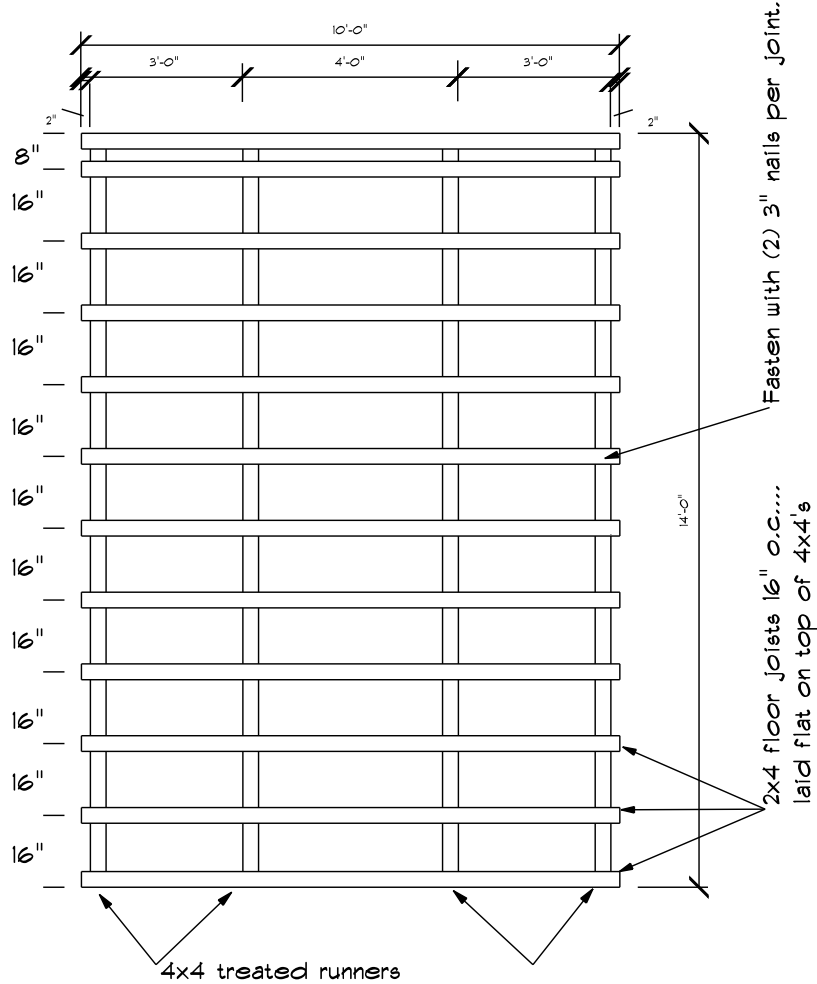

Top View of plywood

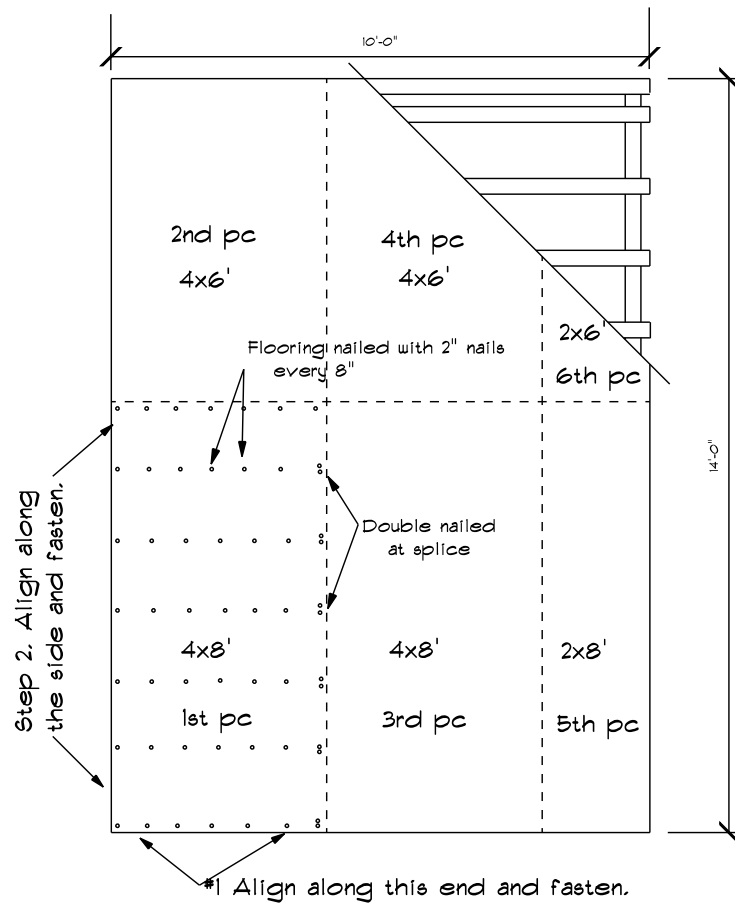

Front View

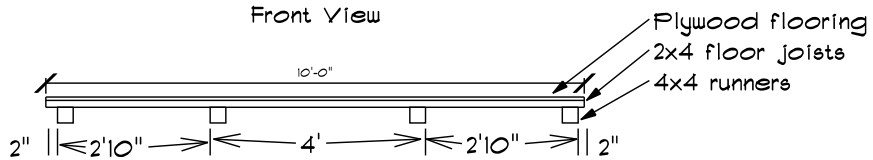

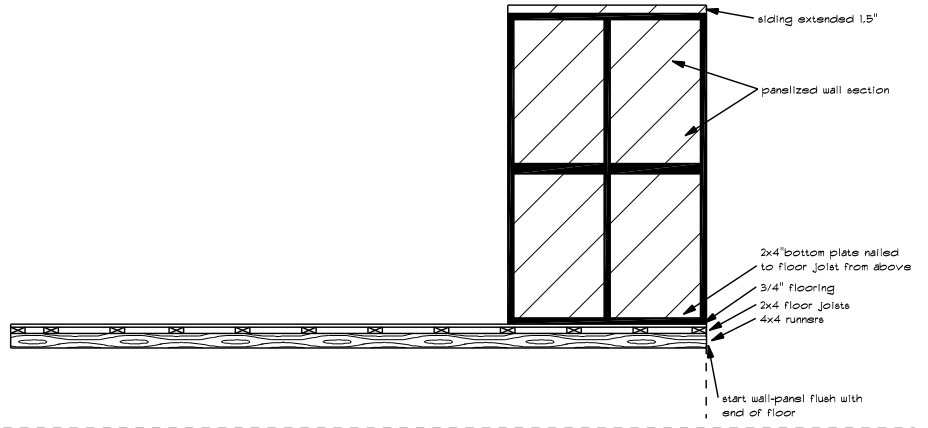
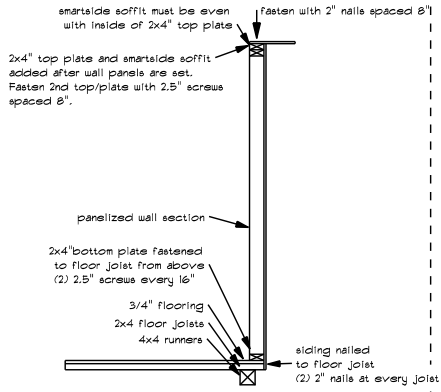

Inside View - Sidewalls 3

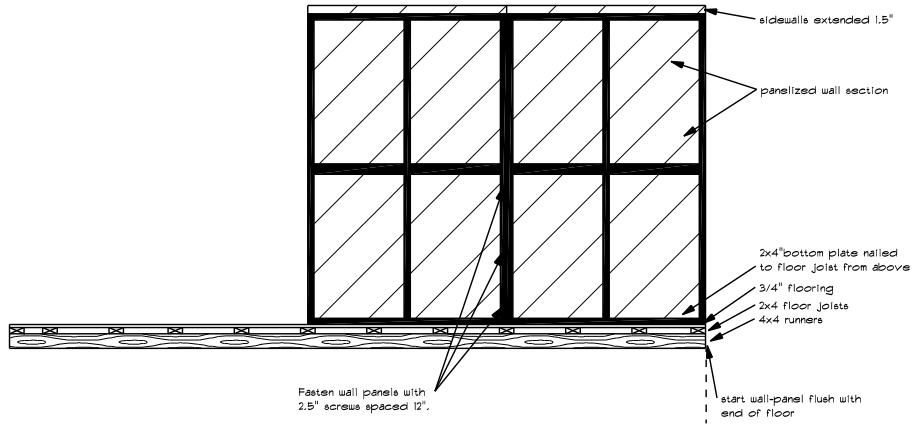

Inside View - Sidewalls 4

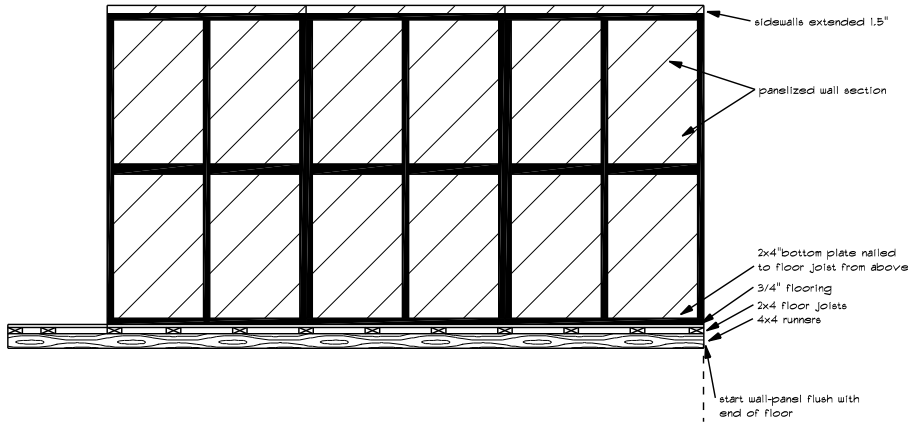

Inside View - Sidewalls 5

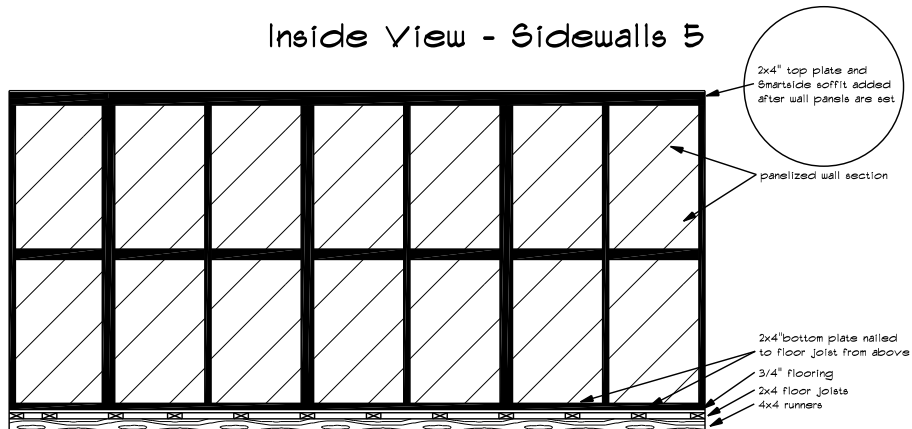

Note: This is an example of a 10x14' Riverside Shed.
 Your particular building size may have different sized wall panels.
 Refer to the paperwork included with your packing list for more details.

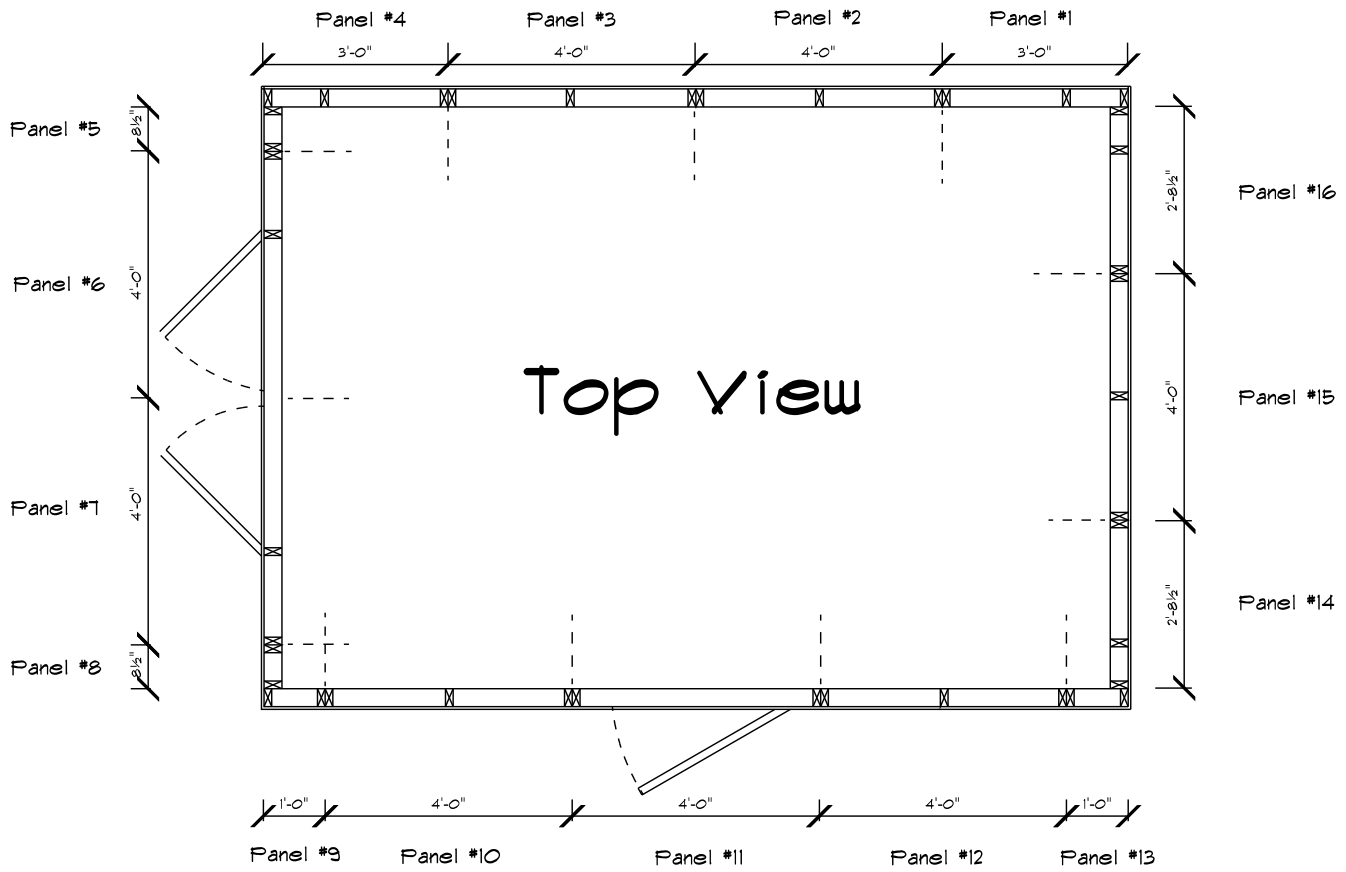

Top View - 2x4" Top/Plates

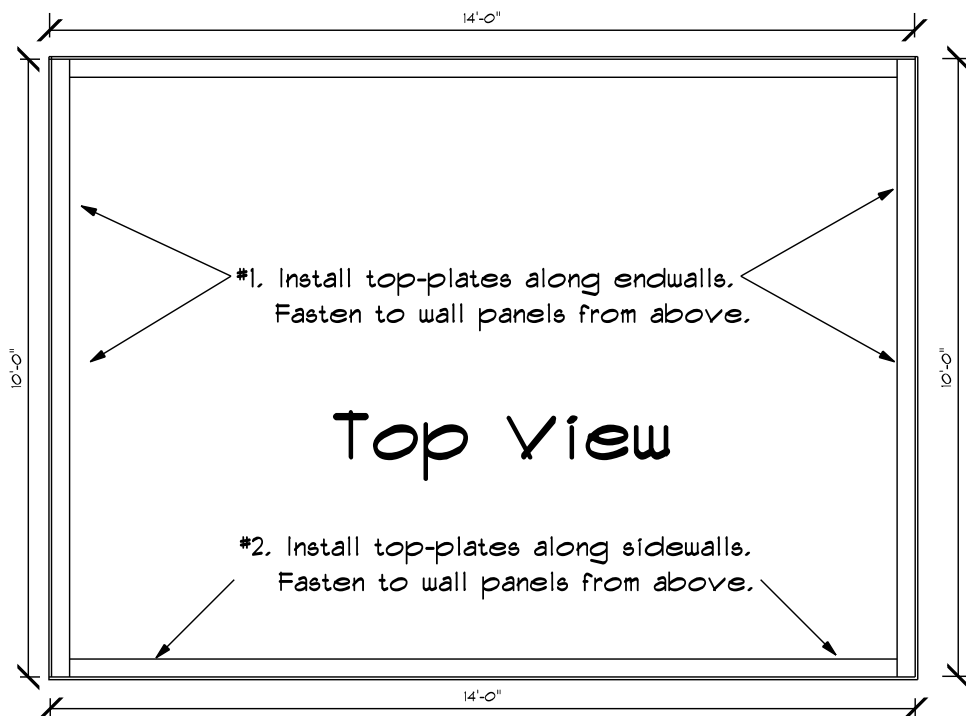

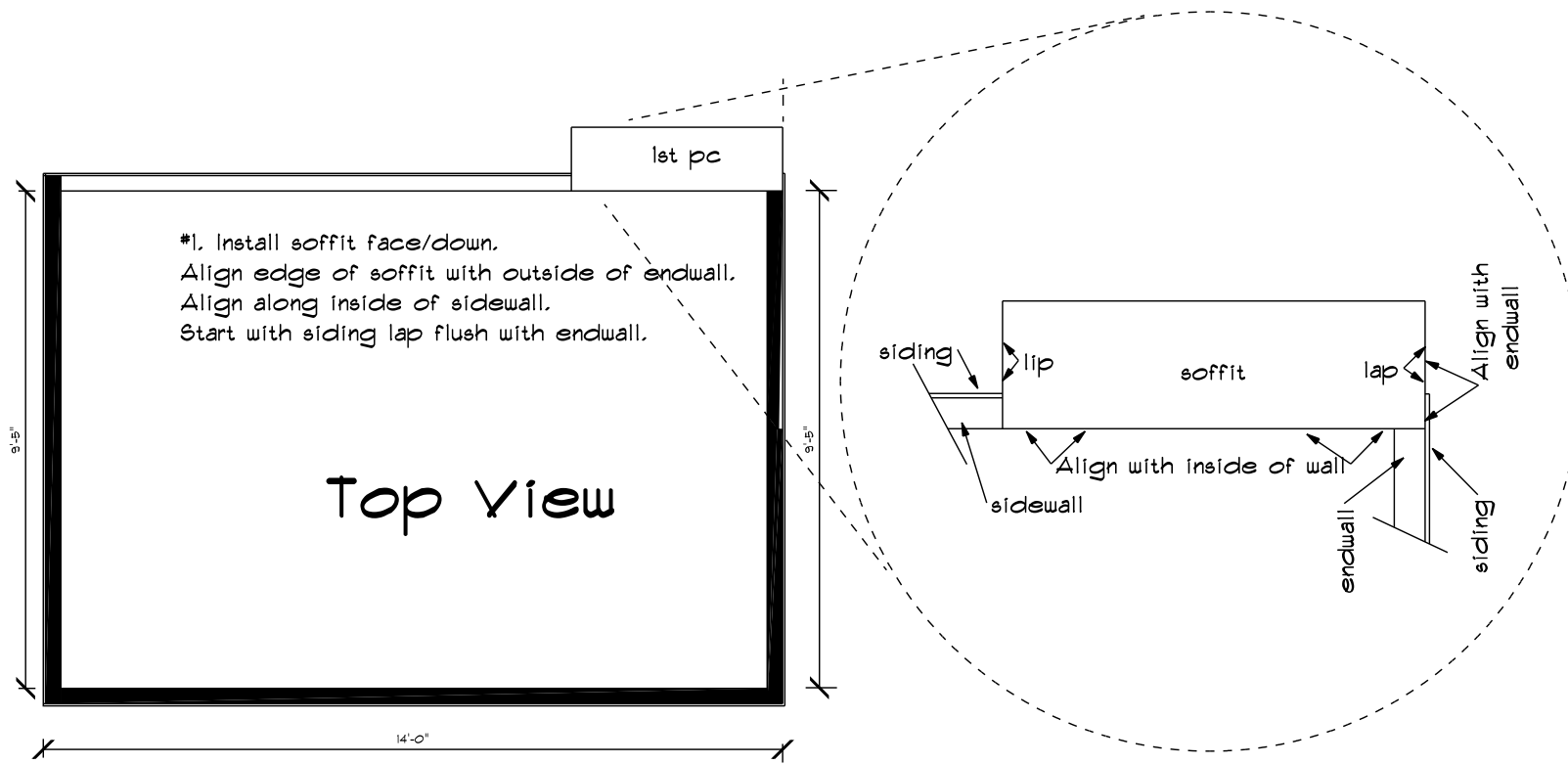

Top View - Smartside Soffit 2

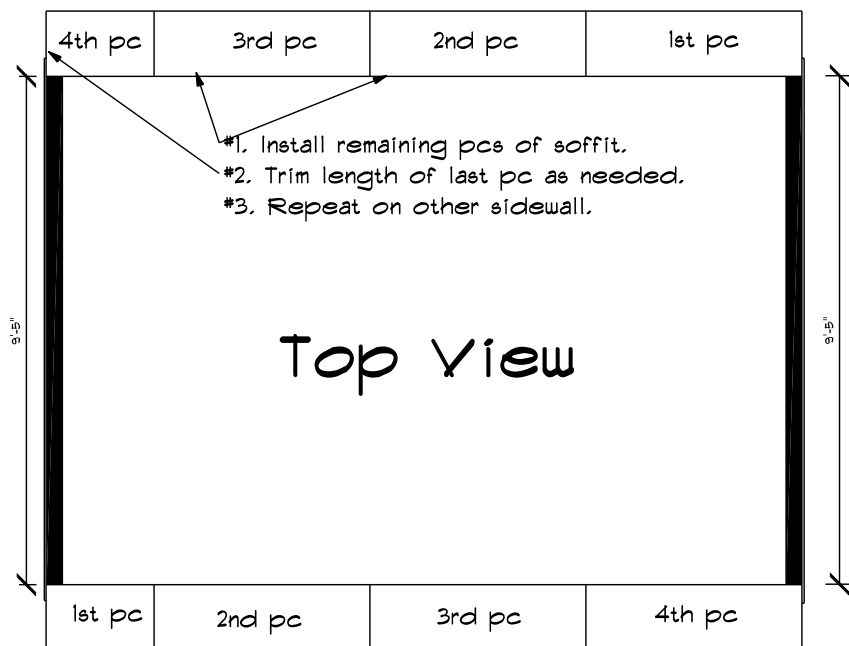

Top view of floor

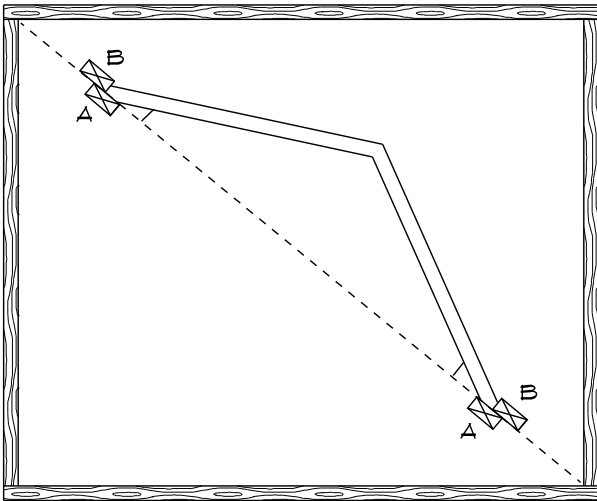

- #1... snap a chalk-line across the corners of floor.
- #2...put 2 stops along bottom of chalk-line (stop"A")
- #3...measure correct distance for overall width of rafter and put down stops "B".
- #4... match up peak of rafters and fasten gussets using 2" nails, 12 nails per gusset, 24 nails per rafter.

Overall width of rafter for Riverside, Heritage and Homestead:
 8' wide building: 9'10"
 10' wide building: 11'10"
 12' wide building: 13'10"
 Overall width of rafter for Cornerstone:
 8' wide building: 8'4"
 10' wide building: 10'4"
 12' wide building: 12'4"

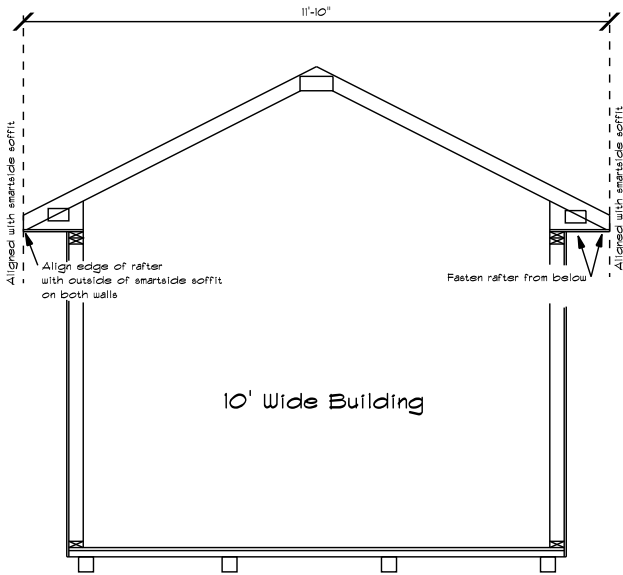

- #1...make sure both sidewalls are straight and brace walls from inside as needed.
- #2... align rafters with outside of smartside soffit and nail thru smartside up into rafter. 2" nails spaced every 3".

Rafters - Side View

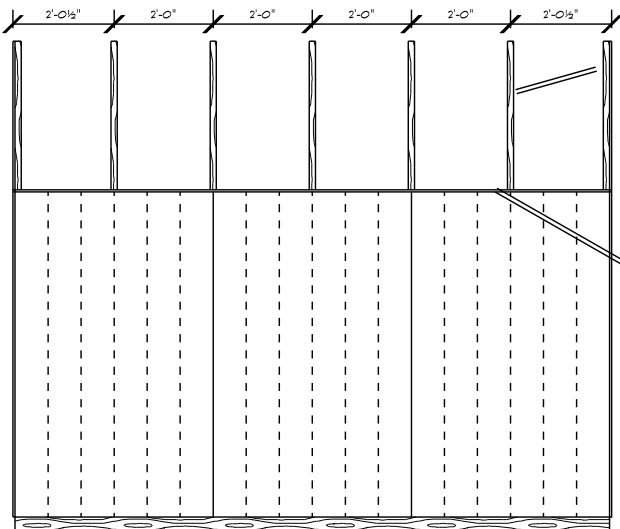

Close-up

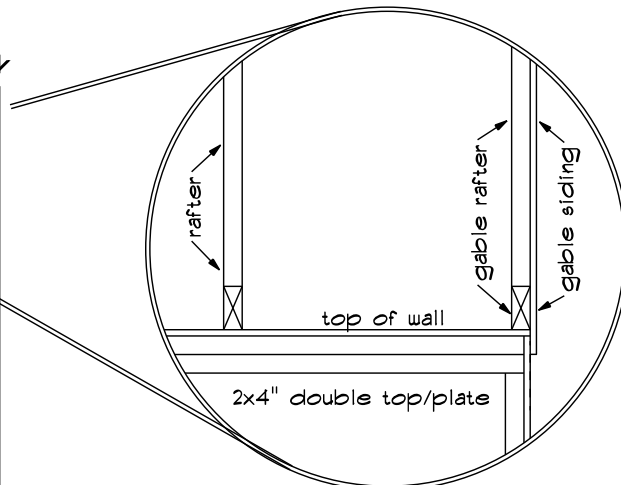

Gable/end Siding Overlay End View

Inside | Outside

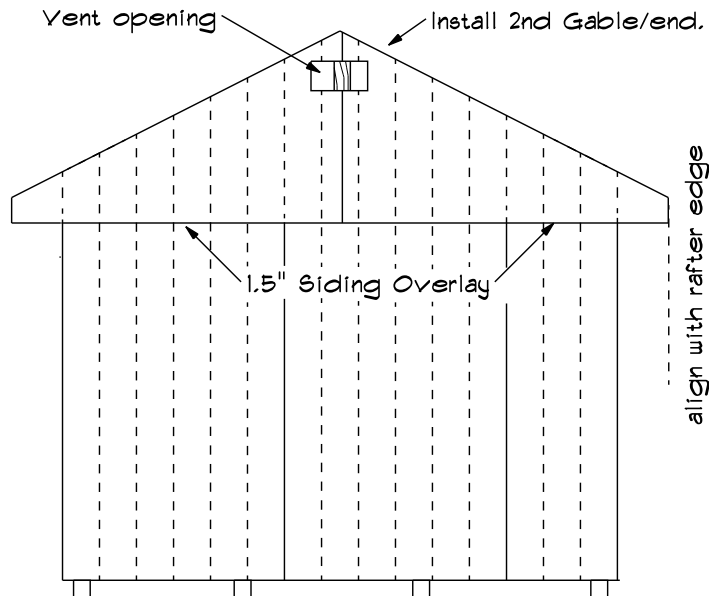
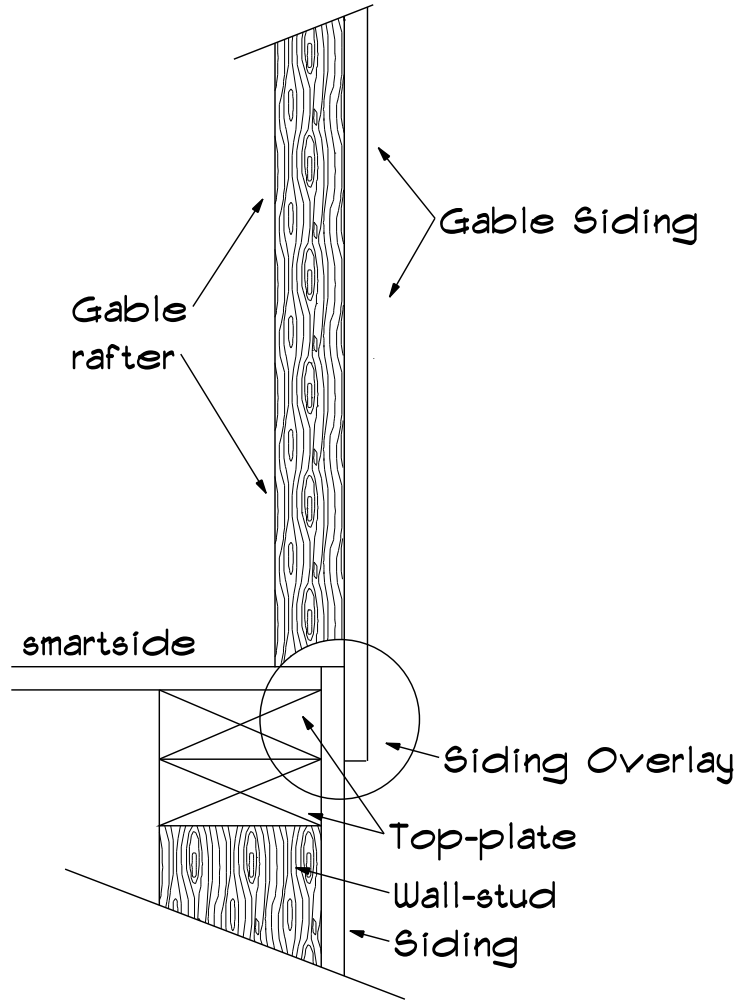
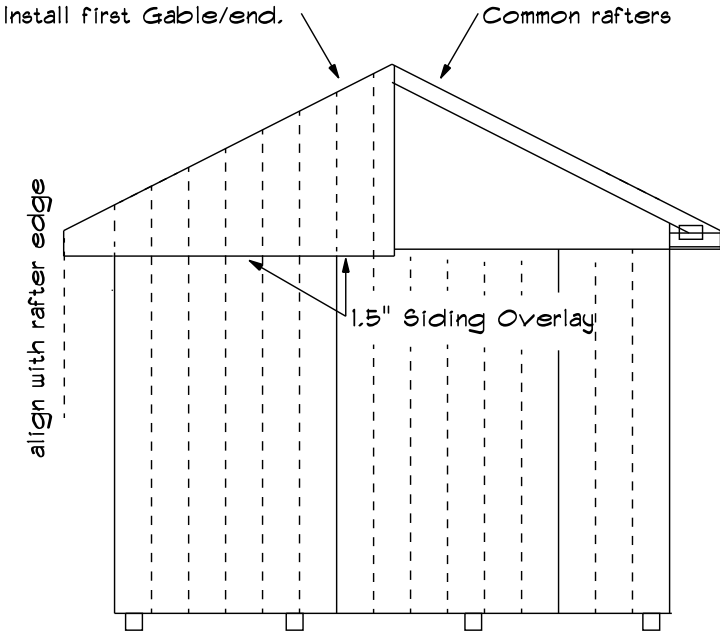

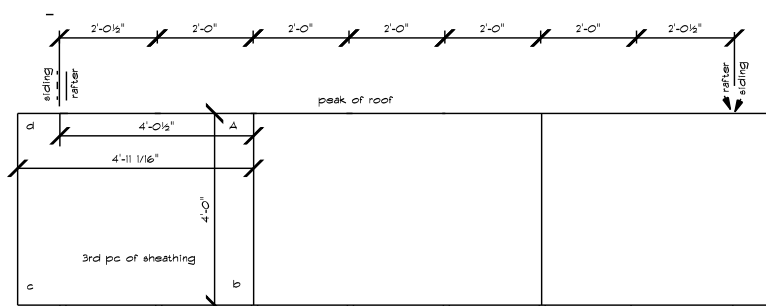

roof sheathing 4

- *1... fasten top right corner first. (A)
- *2... fasten bottom right corner second (b)
- *3... place bottom of sheathing on chalkline and place 48 1/2" mark between the outside of rafter and inside of siding and fasten.
- *4... fasten 4th corner (d) and remainder of sheet

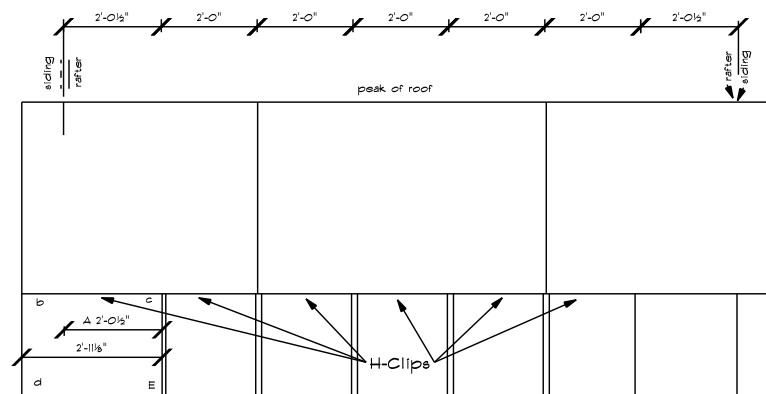

roof sheathing 5

- *1... place an H-clip between each rafter.
- *2... measure 24 1/2" from right to left on sheathing.(A)
- *2... keep outside of sheathing flush and fasten corner (B)
- *3... center right edge of sheathing on rafter and fasten along top. (C)
- *4... place 2' mark between outside of rafter and inside of sheathing and fasten. (D)
- *5... fasten corner (E).

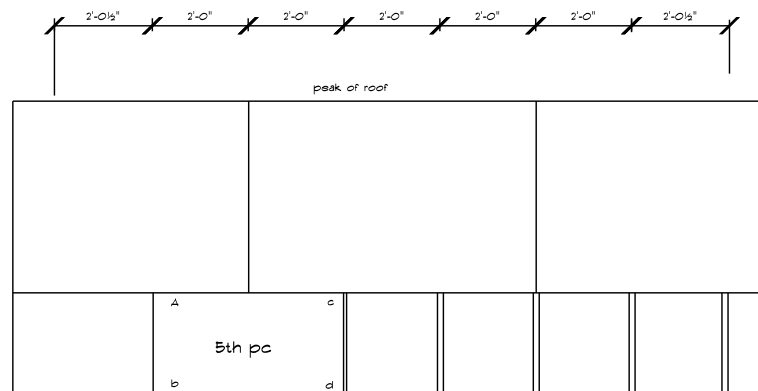

roof sheathing 6

- *1...Mark bottom sheathing 24" o.c.
- *2...Fasten left side of sheathing. (A and B)
- *3...Center right edge of sheathing on rafter and fasten.
- *4...Fasten remainder of sheathing, making sure rafters are spaced 24" o.c.

Remember... make sure H-clips are in place before fastening sheathing.

Roof Trim 1

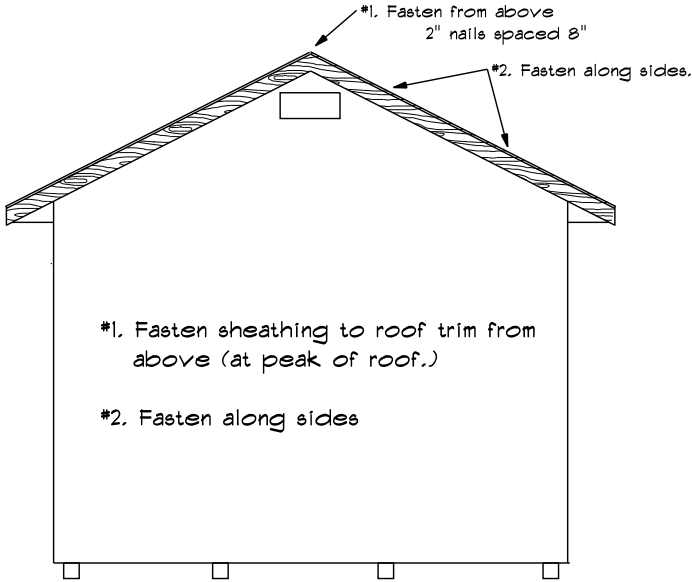

Roof Trim 2

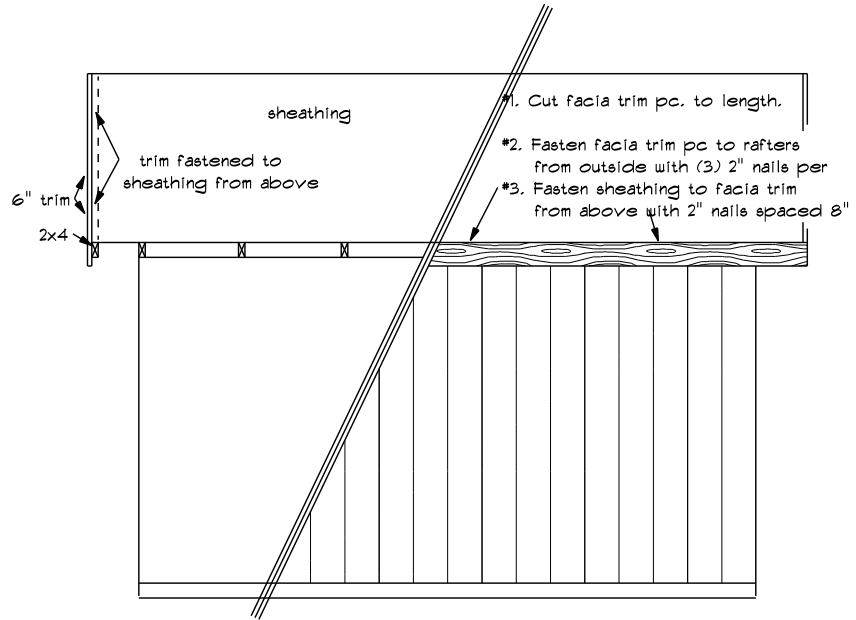

- #1. Install corner trim with 2" nails spaced 8".
- #2. Install windows & shutters with 2" nails spaced 8".
NOTE: be sure to caulk both behind window & above top trim piece.
- #3. Install door hardware with 1.5" black screws.

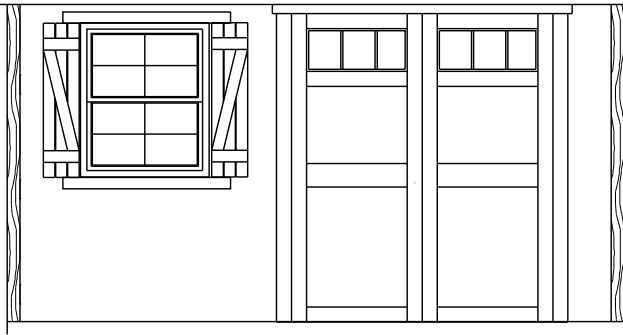

Your building is now ready to be shingled and painted. We recommend using aluminum dripedge along the roof edges.

ON THE INSIDE:

Fasten the wall/panel bottom plates to the floor joists. (nailing down thru the plywood flooring.)
Fasten the wall corner-studs together.
Cut out the 2x4's in the bottom of the door opening. (these aren't needed.)

ON THE DOOR:

Be sure the 2x4x60" is fastened to the top of the door opening. (actual door opening should be 72" tall x 60" wide.)