

BOX EAVE RAFTER END WALL AND SIDE WALL OPENINGS

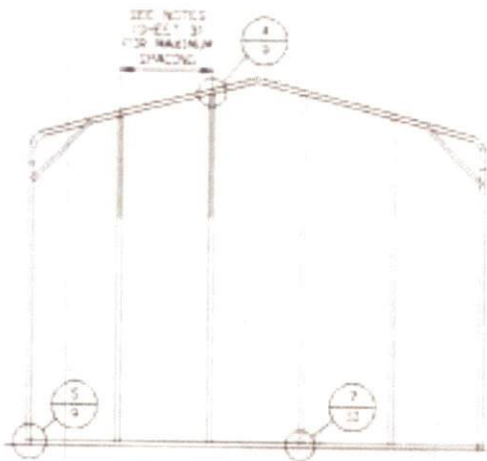

TYPICAL BOX EAVE RAFTER END WALL FRAMING SECTION

SCALE: NTS

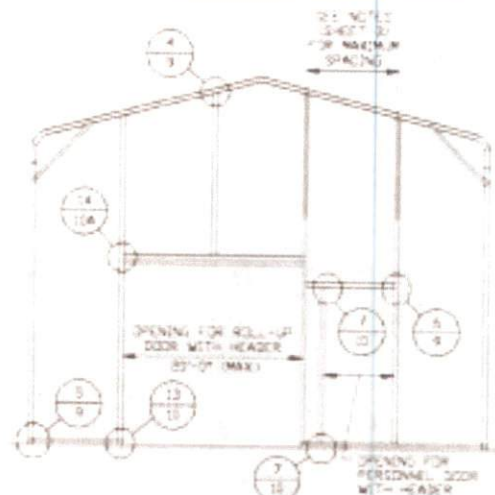

TYPICAL BOX EAVE RAFTER END WALL OPENINGS FRAMING SECTION

SCALE: NTS

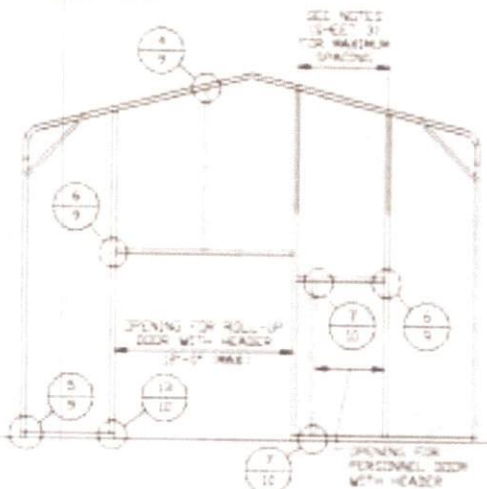

TYPICAL BOX EAVE RAFTER END WALL OPENINGS FRAMING SECTION

SCALE: NTS

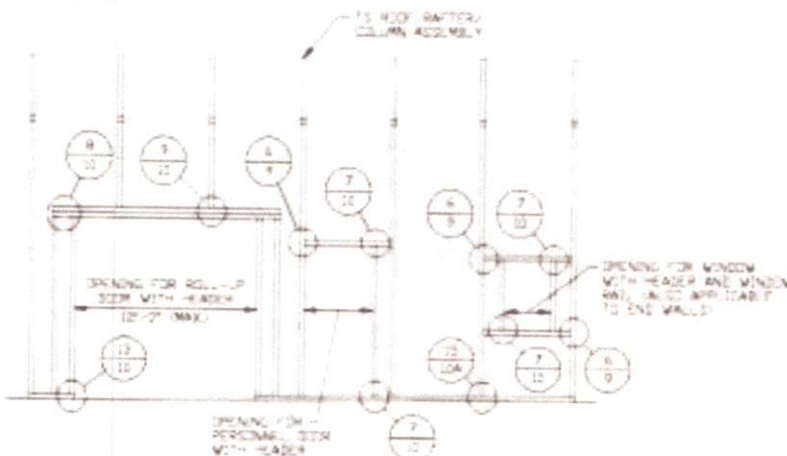

TYPICAL BOX EAVE RAFTER SIDE WALL OPENINGS FRAMING SECTION

SCALE: NTS



**MOORE AND ASSOCIATES
ENGINEERING AND CONSULTING, INC.**

DRAWN BY: JG

CHECKED BY: PH

PROJECT NO: V2H

DATE: 7-2-80

NC CARPORTS AND GARAGES, LLC
309 S. DEPOT STREET
PILOT MOUNTAIN, NC 27041
30'-0" x 16'-0" ENCLOSED STRUCTURE

SCALE: NTS

DATE: 7-2-80

DATE: MD SK-3

MOISS/191798/

JOB NO: 081765

REV: 2

THIS DOCUMENT IS THE PROPERTY OF MOORE AND ASSOCIATES ENGINEERING AND CONSULTING, INC. THE UNAUTHORIZED REPRODUCTION, COPIING, OR OTHERWISE USE OF THIS DOCUMENT IS STRICTLY PROHIBITED AND ANY INFRINGEMENT THEREUPON MAY BE PROSECUTED TO THE FULL EXTENT OF THE LAW.

BOX EAVE RAFTER END WALL AND SIDE WALL OPENINGS

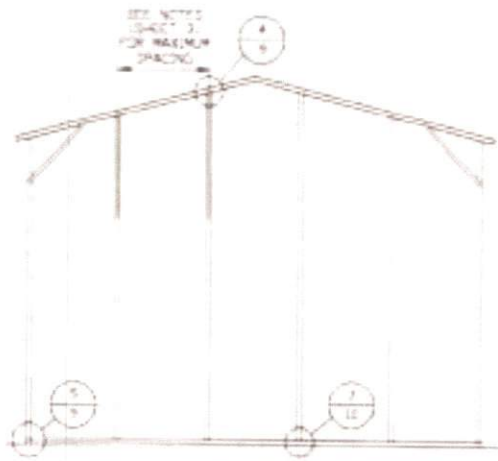

TYPICAL BOX EAVE RAFTER END WALL FRAMING SECTION

SCALE: NTS

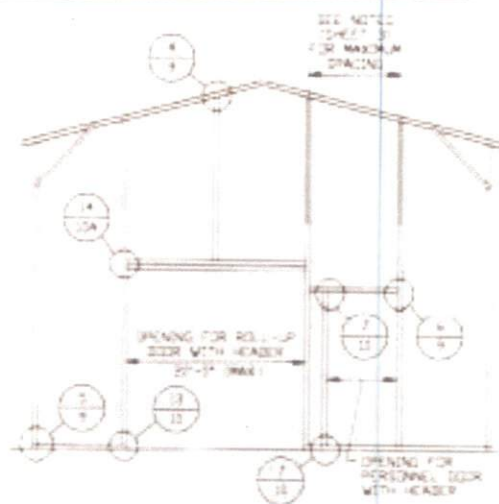

TYPICAL BOX EAVE RAFTER END WALL OPENINGS FRAMING SECTION

SCALE: NTS

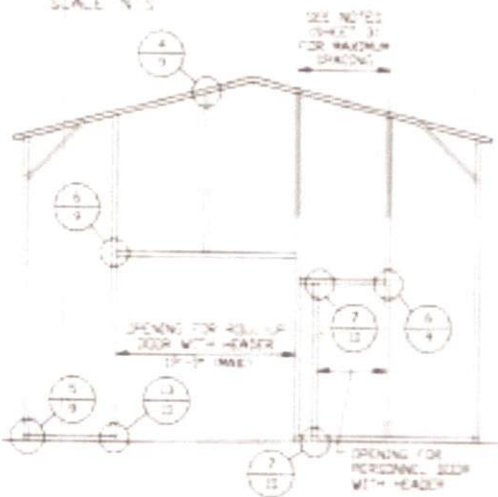

TYPICAL BOX EAVE RAFTER END WALL OPENINGS FRAMING SECTION

SCALE: NTS

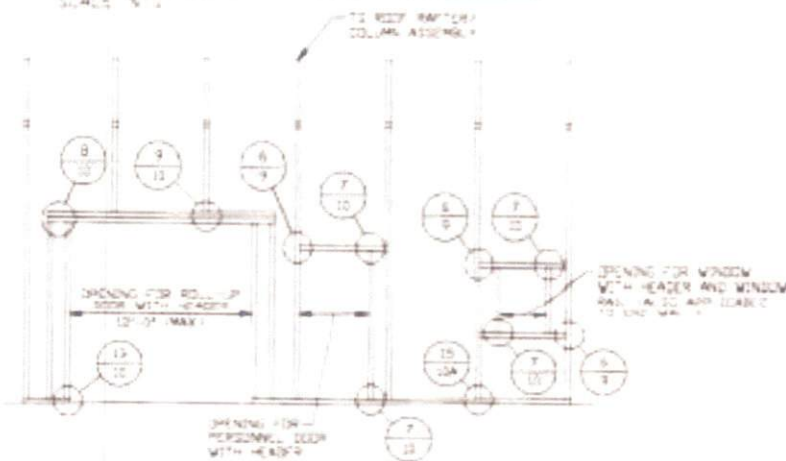

TYPICAL BOX EAVE RAFTER SIDE WALL OPENINGS FRAMING SECTION

SCALE: NTS



**MOORE AND ASSOCIATES
ENGINEERING AND CONSULTING, INC.**

DRAWN BY: JB

CHECKED BY: PH

PROJECT NO: VSM

DATE: 7-2-09

NC CARPORTS AND GARAGES, LLC
309 S. DEPOT STREET
PILOT MOUNTAIN, NC 27041
30'-0" x 16'-0" ENCLOSED STRUCTURE

SCALE: NTS

DATE: 7-2-09

JOB NO: 08768

ISSUE/191799/

DWG. NO: SK-3

REV: 2

THIS DOCUMENT IS THE PROPERTY OF MOORE AND ASSOCIATES ENGINEERING AND CONSULTING, INC. UNAUTHORIZED REPRODUCTION, COPIES, OR OTHERWISE USE OF THIS DOCUMENT IS STRICTLY PROHIBITED AND ANY SUCH VIOLATION THEREUPON MAY BE PROSECUTED.

BOX EAVE RAFTER VERTICAL ROOF/SIDING OPTION

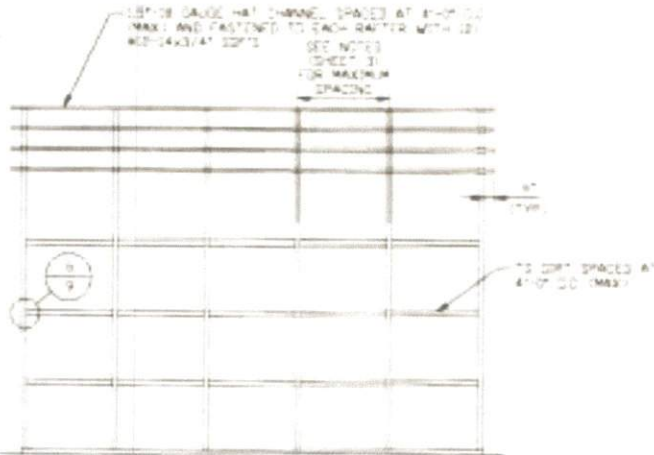

**TYPICAL FRAMING SECTION
VERTICAL ROOF/SIDING OPTION
WITH TS GIRTS**

SCALE: NTS



**MOORE AND ASSOCIATES
ENGINEERING AND CONSULTING, INC.**

DRAWN BY: JB
CHECKED BY: PH

NC GARAGES AND GARAGES, LLC
309 S. DEPOT STREET
PILOT MOUNTAIN, NC 27041
30'-0" x 16'-0" ENCLOSED STRUCTURE

THIS DOCUMENT IS THE PROPERTY OF MOORE AND ASSOCIATES ENGINEERING AND CONSULTING, INC. ANY REPRODUCTION, COPIING, OR OTHER USE OF THIS DOCUMENT IS STRICTLY PROHIBITED AND ANY VIOLATION THEREOF MAY BE SUBJECT TO LEGAL ACTION.

PROJECT NO: VSM	DATE: 7-8-88	SCALE: NTS	JOB NO: 881765
CLIENT: MO. GARAGES	DWG. NO: SK-3	REV.: 2	

BOX EAVE RAFTER VERTICAL ROOF/SIDING OPTION

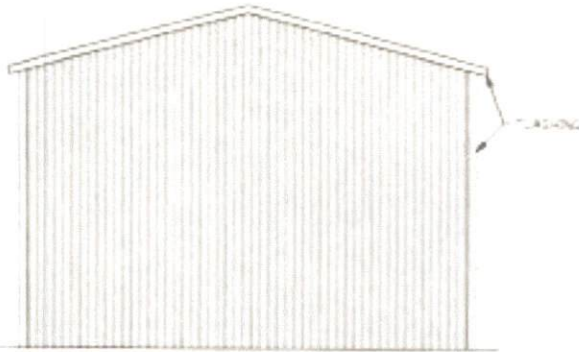

**TYPICAL END ELEVATION
VERTICAL ROOF/SIDING**

SCALE: NTS

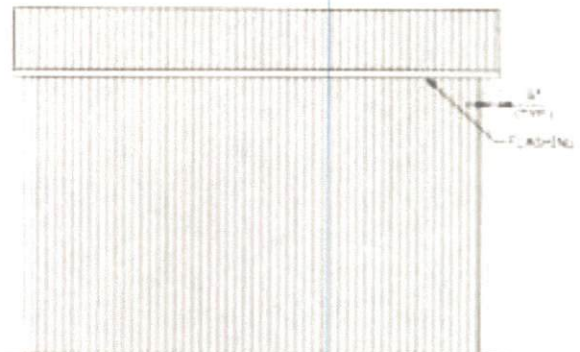

**TYPICAL SIDE ELEVATION
VERTICAL ROOF/SIDING**

SCALE: NTS

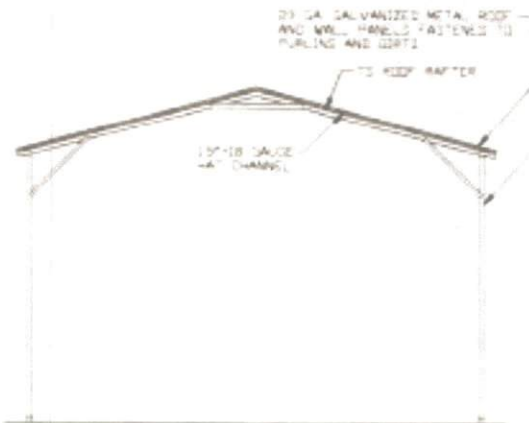

**TYPICAL SECTION
VERTICAL ROOF/SIDING OPTION**

SCALE: NTS

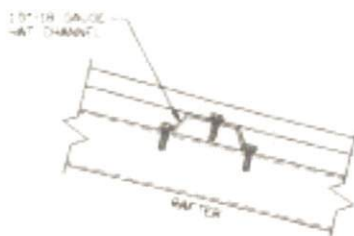

PANEL ATTACHMENT

ALTERNATE FOR VERTICAL ROOF PANELS
SCALE: NTS



**MOORE AND ASSOCIATES
ENGINEERING AND CONSULTING, INC.**

DRAWN BY: JS

CHECKED BY: PH

PROJECT NO: VSH

CLIENT: NC CARPORTS

NC CARPORTS AND GARAGES, LLC
300 S. DEPOT STREET
PILOT MOUNTAIN, NC 27041
36'-0" x 16'-0" ENCLOSED STRUCTURE

DATE: 7-2-20

SHT. 12

SCALE: NTS

DWG. NO. SK-3

18322/191796/
JOB NO. 201755

REV. 2

THIS DOCUMENT IS THE PROPERTY OF MOORE AND ASSOCIATES ENGINEERING AND CONSULTING, INC. UNAUTHORIZED REPRODUCTION, COPIES, OR OTHERWISE USE OF THIS DOCUMENT IS STRICTLY PROHIBITED AND ANY INFRINGEMENT THEREUPON MAY BE SUBJECT TO LEGAL ACTION.

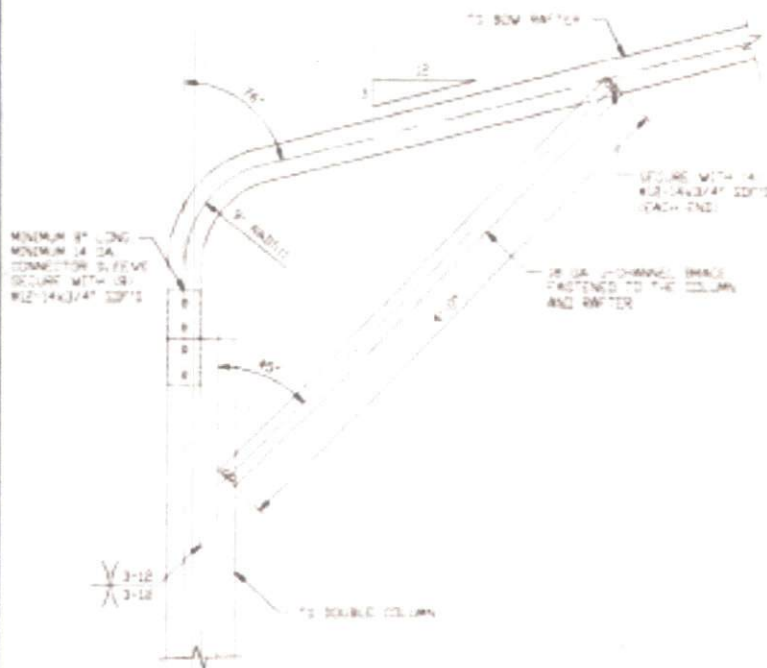

1A

BOX EAVE RAFTER/CORNER POST CONNECTION DETAIL FOR HEIGHTS 12'-0" < TO < 16'-0"

SCALE: NTS

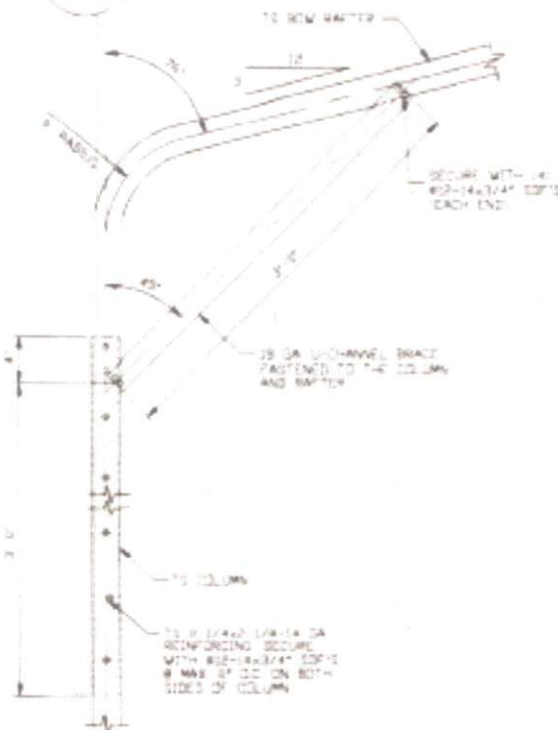

1B

BOW RAFTER/CORNER POST CONNECTION DETAIL FOR HEIGHTS 10'-0" < TO < 12'-0"

SCALE: NTS

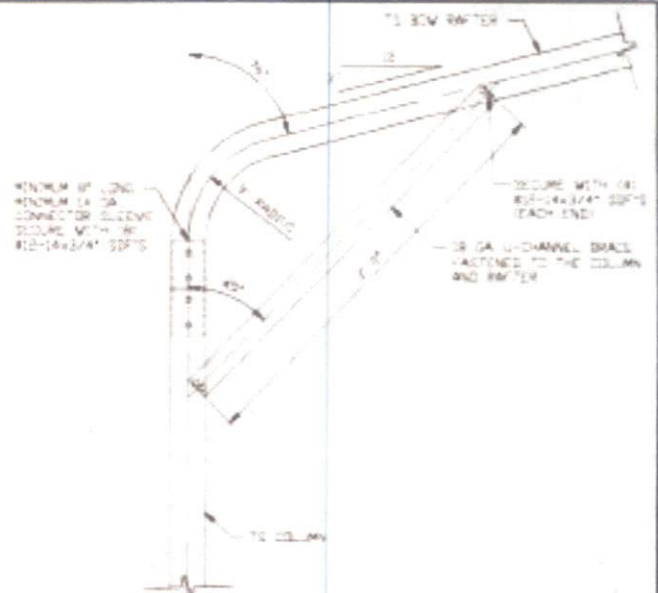

1C

BOX EAVE RAFTER/CORNER POST CONNECTION DETAIL FOR HEIGHTS < 10'-0"

SCALE: NTS



BRACE SECTION

SCALE: NTS



MOORE AND ASSOCIATES ENGINEERING AND CONSULTING, INC.

DRAWN BY: JG

CHECKED BY: PH

PROJECT NO: VSH

NC CARPORTS AND GARAGES, LLC
309 S. DEPOT STREET
PILOT MOUNTAIN, NC 27041
30'-0" X 16'-0" ENCLOSED STRUCTURE

DATE: 7-2-88

SCALE: NTS

JOB NO: 88265

183158/191796/

REV. 5

DWG. NO SK-3

REV. 2

THIS DOCUMENT IS THE PROPERTY OF MOORE AND ASSOCIATES ENGINEERING AND CONSULTING, INC. UNAUTHORIZED REPRODUCTION, COPYING, OR OVERLAP USE OF THIS DOCUMENT IS STRICTLY PROHIBITED AND ANY INFRINGEMENT THEREUPON MAY BE PROSECUTED TO THE FULL EXTENT OF THE LAW.

BASE RAIL ANCHORAGE OPTIONS

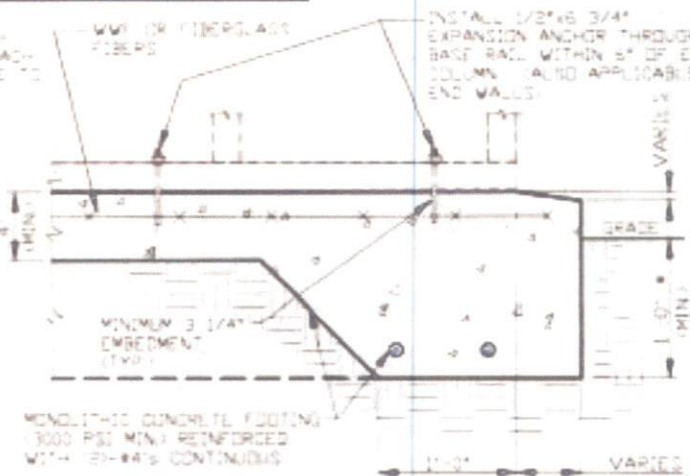
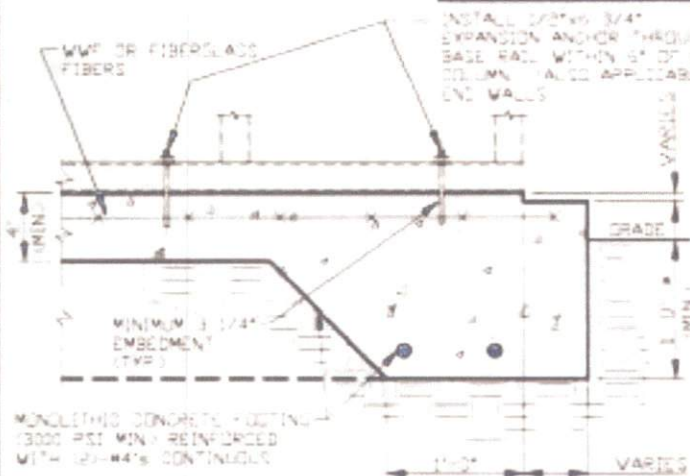

2A

CONCRETE MONOLITHIC SLAB BASE RAIL ANCHORAGE

SCALE: NTS
MINIMUM ANCHOR EDGE DISTANCE IS 4"
* COORDINATE WITH LOCAL BUILDING CODE AND/OR REGARDING MINIMUM FROST DEPTH LENGTH

2B

CONCRETE MONOLITHIC SLAB BASE RAIL ANCHORAGE

SCALE: NTS
MINIMUM ANCHOR EDGE DISTANCE IS 4"
* COORDINATE WITH LOCAL BUILDING CODE AND/OR REGARDING MINIMUM FROST DEPTH LENGTH

GENERAL NOTES

NOTE: CONCRETE MONOLITHIC SLAB DESIGN BASED ON MINIMUM SOIL BEARING CAPACITY OF 1500 PSF

CONCRETE:

CONCRETE SHALL HAVE A MINIMUM SPECIFIED COMPRESSIVE STRENGTH OF 3000 PSI AT 28 DAYS

COVER OVER REINFORCING STEEL:

FOR FOUNDATIONS: MINIMUM CONCRETE COVER OVER REINFORCING BARS SHALL BE PER ACI 308
3" IN FOUNDATIONS WHERE THE CONCRETE IS CAST AGAINST AND PERMANENTLY IN CONTACT WITH THE EARTH OR EXPOSED TO THE EARTH OR WEATHER AND 1 1/2" ELSEWHERE

REINFORCING STEEL:

THE TURNDOWN REINFORCING STEEL SHALL BE ASTM A615 GRADE SO THE SLAB REINFORCEMENT SHALL BE WELDED WIRE FABRIC, MESHING, ASTM A195 OR FIBERGLASS FIBER REINFORCEMENT

REINFORCEMENT MAY BE BENT IN THE SHOP OR THE FIELD PROVIDED:

1. REINFORCEMENT IS BENT 90°
2. THE DIAMETER OF THE BEND MEASURED ON THE INSIDE OF THE BAR IS NOT LESS THAN SIX-BAR DIAMETERS
3. REINFORCEMENT PARTIALLY EMBEDDED IN CONCRETE SHALL NOT BE FIELD BENT

HELIX ANCHOR NOTES:

1. FOR VERY DENSE AND/OR BLENDED SANDS, COARSE GRAVEL AND COBBLES, CALICHE, PRELOADED SILTS AND CLAYS USE MINIMUM (2) 4" HELICES WITH MINIMUM 30" EMBEDMENT OR SINGLE 6" HELIX WITH MINIMUM 50" EMBEDMENT
2. FOR CORAL USE MINIMUM (2) 4" HELICES WITH MINIMUM 30" EMBEDMENT OR SINGLE 6" HELIX WITH MINIMUM 50" EMBEDMENT
3. FOR MEDIUM DENSE COARSE SANDS, SANDY GRAVELS, VERY STIFF SILTS AND CLAYS USE MINIMUM (2) 4" HELICES WITH MINIMUM 30" EMBEDMENT OR SINGLE 6" HELIX WITH MINIMUM 50" EMBEDMENT
4. FOR LOOSE TO MEDIUM DENSE SANDS, FIRM TO STIFF CLAYS AND SILTS ALLUVIAL FILL USE MINIMUM (2) 6" HELICES WITH MINIMUM 50" EMBEDMENT
5. FOR VERY LOOSE TO MEDIUM DENSE SANDS, FIRM TO STIFFER CLAYS AND SILTS ALLUVIAL FILL USE MINIMUM (2) 6" HELICES WITH MINIMUM 60" EMBEDMENT



**MOORE AND ASSOCIATES
ENGINEERING AND CONSULTING, INC.**

DRAWN BY: JG

CHECKED BY: PH

PROJECT NO: VBN

NC CARPORTS AND GARAGES, LLC
309 S. DEPOT STREET
PILOT MOUNTAIN, NC 27041
30'-0" x 16'-0" ENCLOSED STRUCTURE

DATE: 7-2-20

SCALE: NTS

JOB NO: 201765

DATE OF ADDRESS

SHEET: 7

DWG. NO: SK-3

REV: 2

THIS DOCUMENT IS THE PROPERTY OF MOORE AND ASSOCIATES ENGINEERING AND CONSULTING, INC. UNAUTHORIZED REPRODUCTION, COPIING, OR OTHERWISE USE OF THIS DOCUMENT IS STRICTLY PROHIBITED AND ANY VIOLATION THEREOF MAY

ISSUE/191796/

BASE RAIL ANCHORAGE OPTIONS

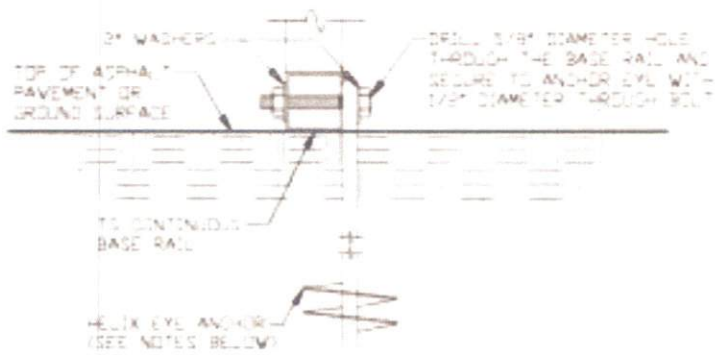

2C GROUND BASE HELIX ANCHORAGE
SCALE: NTS
(CAN BE USED FOR ASPHALT)

• COORDINATE WITH LOCAL BUILDING CODE AND/OR REGARDING MINIMUM FROST DEPTH LENGTH

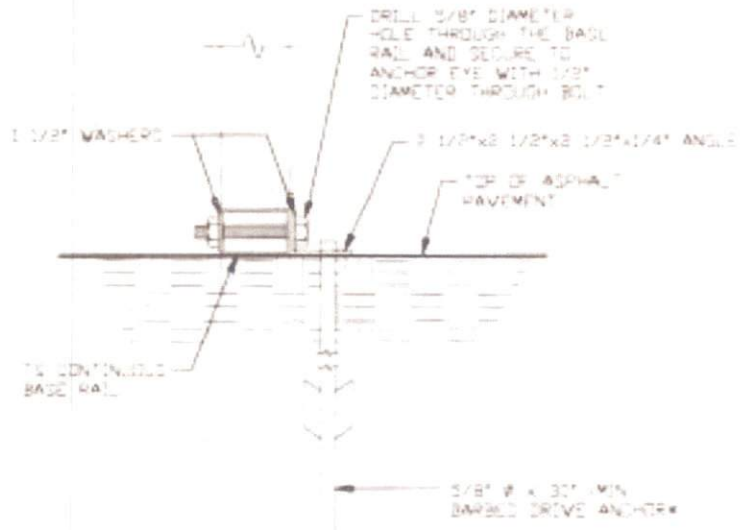

2D ASPHALT BASE ANCHORAGE
SCALE: NTS

• COORDINATE WITH LOCAL BUILDING CODE AND/OR REGARDING MINIMUM FROST DEPTH LENGTH



**MOORE AND ASSOCIATES
ENGINEERING AND CONSULTING, INC.**

DRAWN BY: JG
CHECKED BY: PH

NC AIRPORTS AND GARAGES, LLC
309 S. DEPOT STREET
PILOT MOUNTAIN, NC 27041
30'-0" x 16'-0" ENCLOSED STRUCTURE

PROJECT NO: V281	DATE: 7-8-80	SCALE: NTS	JOB NO.: 881785
DATE OF CHANGE:	BY: 7A	NO. OF SK-3:	REV.: 2

THIS DOCUMENT IS THE PROPERTY OF MOORE AND ASSOCIATES ENGINEERING AND CONSULTING, INC. UNAUTHORIZED REPRODUCTION, COPIES, OR DISSEMINATION OF THIS DOCUMENT IS STRICTLY PROHIBITED AND ANY VIOLATION THEREOF MAY BE PROSECUTED.

CONNECTION DETAILS



3A

POST/BASE RAIL CONNECTION DETAIL

SCALE: NTS



3B

POST/BASE RAIL CONNECTION DETAIL

SCALE: NTS



4

END COLUMN/RAFTER CONNECTION DETAIL

SCALE: NTS

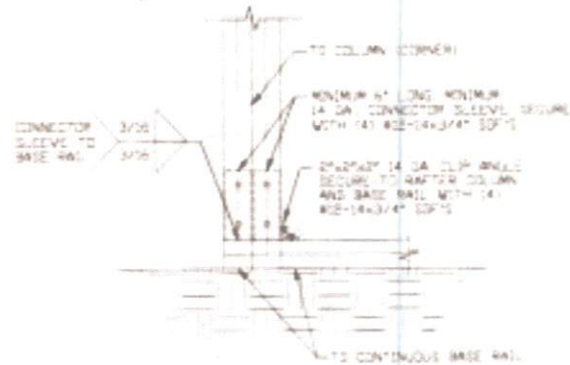

5A

END COLUMN/BASE RAIL CONNECTION DETAIL

SCALE: NTS



5B

END COLUMN/BASE RAIL CONNECTION DETAIL

SCALE: NTS



6

COLUMN OR WINDOW RAIL TO POST CONNECTION DETAIL

SCALE: NTS



**MOORE AND ASSOCIATES
ENGINEERING AND CONSULTING, INC.**

DRAWN BY: JG

CHECKED BY: PH

PROJECT NO: V3H

DATE: 7-2-20

SHEET: 9

NC CARPORTS AND GARAGES, LLC
309 S. DEPOT STREET
PILOT MOUNTAIN, NC 27041
30'-0" x 16'-0" ENCLOSED STRUCTURE

SCALE: NTS

DWG NO: SK-3

10/25/2019/2020
JOB NO: 201765

REV: 2

THIS DOCUMENT IS THE PROPERTY OF MOORE AND ASSOCIATES ENGINEERING AND CONSULTING, INC. UNAUTHORIZED REPRODUCTION, COPIING, OR OTHERWISE USE OF THIS DOCUMENT IS STRICTLY PROHIBITED AND ANY REPRODUCTION THEREUPON MAY BE SUBJECT TO PROSECUTION.

CONNECTION DETAILS

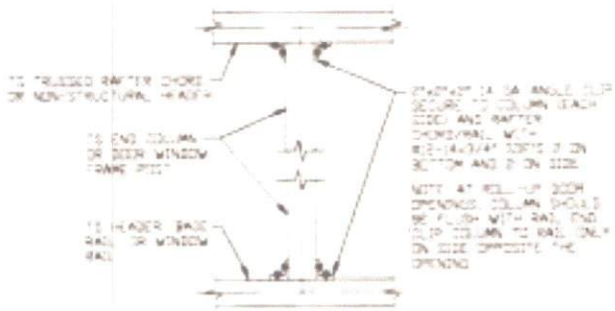

7 COLUMN TO HEADER, BASE RAIL, OR WINDOW RAIL CONNECTION DETAIL
SCALE: NTS



8 DOUBLE HEADER/COLUMN CONNECTION DETAIL
SCALE: NTS



9 COLUMN/DOUBLE HEADER CONNECTION DETAIL
SCALE: NTS

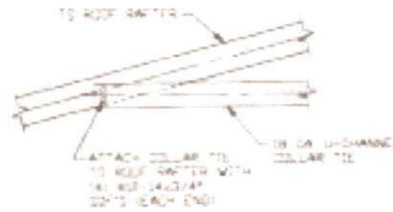

10 COLLAR TIE CONNECTION DETAIL
SCALE: NTS

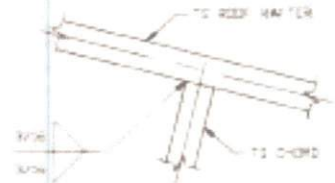

11 RAFTER TO CHORD CONNECTION DETAIL
SCALE: NTS



12 COLLAR TIE CONNECTION DETAIL
SCALE: NTS



13 COLUMN/BASE RAIL CONNECTION DETAIL
SCALE: NTS



**MOORE AND ASSOCIATES
ENGINEERING AND CONSULTING, INC.**

DRAWN BY: JS
CHECKED BY: PH
PROJECT NO: VSN
CLIENT: NC CARPORTS

NC CARPORTS AND GARAGES, LLC
309 S. DEPOT STREET
PILOT MOUNTAIN, NC 27041
30'-0\"/>

DATE: 7-6-20	SCALE: NTS	JOB NO: 20765
SHT. 10	DWG. NO: SK-3	REV. 2

THIS DOCUMENT IS THE PROPERTY OF MOORE AND ASSOCIATES ENGINEERING AND CONSULTING, INC. UNAUTHORIZED REPRODUCTION, COPYING, OR OTHERWISE USE OF THIS DOCUMENT IS STRICTLY PROHIBITED AND ANY SUCH VIOLATION WILL BE PROSECUTED TO THE FULL EXTENT OF THE LAW.

CONNECTION DETAILS

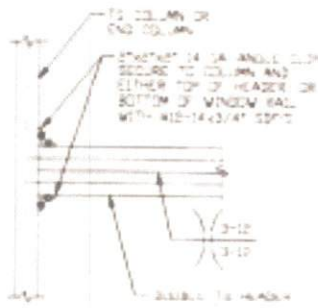

**DOUBLE HEADER
TO COLUMN
CONNECTION DETAIL**

14

SCALE: NTS

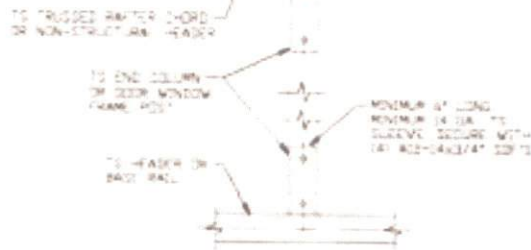

**COLUMN TO HEADER
OR BASE RAIL
CONNECTION DETAIL**

15

SCALE: NTS



**MOORE AND ASSOCIATES
ENGINEERING AND CONSULTING, INC.**

DRAWN BY: J5

CHECKED BY: PH

PROJECT NO: VSH

NC CARPORTS AND GARAGES, LLC
309 S. DEPOT STREET
PILOT MOUNTAIN, NC 27041
30'-0" x 16'-0" ENCLOSED STRUCTURE

DATE: 7-8-80

SCALE: NTS

JOB NO: 801765

THIS DOCUMENT IS THE PROPERTY OF MOORE AND ASSOCIATES ENGINEERING AND CONSULTING, INC. UNAUTHORIZED REPRODUCTION, COPYING, OR OTHERWISE USE OF THIS DOCUMENT IS STRICTLY PROHIBITED AND ANY VIOLATION THEREOF MAY BE PROSECUTED TO THE FULL EXTENT OF THE LAW.

10/28/1987/

JOB NO: 801765

DATE: 7-8-80

SCALE: NTS

JOB NO: 801765

BOX EAVE RAFTER LEAN-TO OPTIONS

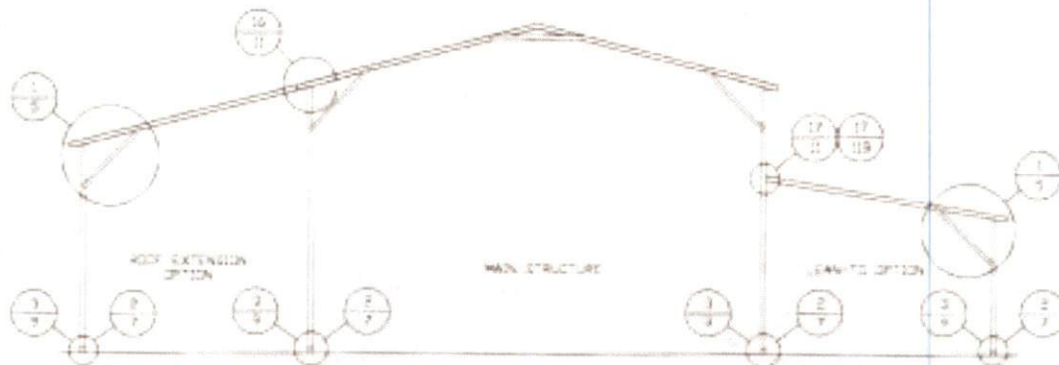

TYPICAL BOX EAVE RAFTER LEAN-TO OPTIONS FRAMING SECTION (BOTH OPTIONS SHOWN)

SCALE: NTS
 MAXIMUM WIDTH OF SINGLE MEMBER ROOF EXTENSION AND LEAN-TO OPTION IS 12'-0"
 MAXIMUM WIDTH OF DOUBLE MEMBER ROOF EXTENSION AND LEAN-TO OPTION IS 16'-0"

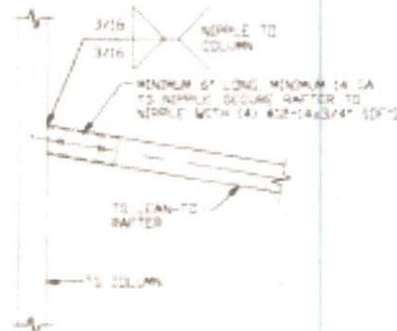
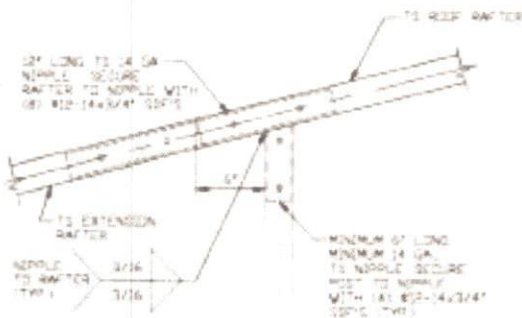

LEAN-TO RAFTER TO RAFTER POST CONNECTION DETAIL FOR WIDTHS $\le 12'-0''$

17A

SCALE: NTS

16

ROOF EXTENSION RAFTER/CORNER POST DETAIL FOR WIDTHS $\le 12'-0''$

SCALE: NTS

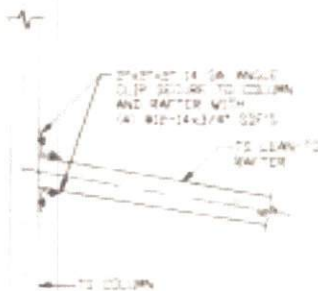

LEAN-TO RAFTER TO RAFTER POST CONNECTION DETAIL FOR WIDTHS $\le 12'-0''$

17B

SCALE: NTS



**MOORE AND ASSOCIATES
 ENGINEERING AND CONSULTING, INC.**

DRAWN BY: JG

CHECKED BY: PH

PROJECT NO: VSM

NC CARPORTS AND GARAGES, LLC
 309 S. DEPOT STREET
 PILOT MOUNTAIN, NC 27041
 30'-0" x 16'-0" ENCLOSED STRUCTURE

DATE: 7-8-80

SCALE: NTS

JOB NO: 001765

183135/191792/

BY: MOORE AND ASSOCIATES

INT. 11

DATE: 06-11-80

REV: 2

THIS DOCUMENT IS THE PROPERTY OF MOORE AND ASSOCIATES ENGINEERING AND CONSULTING, INC. UNAUTHORIZED REPRODUCTION, COPIES, OR OTHER USE OF THIS DOCUMENT IS STRICTLY PROHIBITED AND ANY INFRINGEMENT THEREOF WILL BE PROSECUTED TO THE FULL EXTENT OF THE LAW.

BOX EAVE RAFTER LEAN-TO OPTIONS

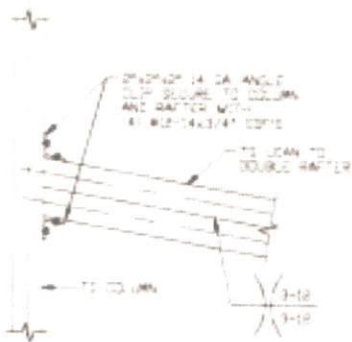

**LEAN-TO RAFTER TO RAFTER
POST CONNECTION DETAIL FOR
WIDTHS 12'-0" < TO ≤ 16'-0"**

17C

SCALE: NTS

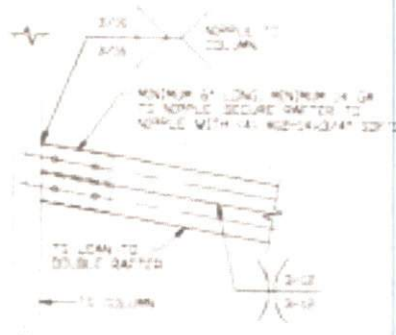

**LEAN-TO RAFTER TO RAFTER
POST CONNECTION DETAIL FOR
WIDTHS 12'-0" < TO ≤ 16'-0"**

17D

SCALE: NTS



**MOORE AND ASSOCIATES
ENGINEERING AND CONSULTING, INC.**

DRAWN BY: JG

CHECKED BY: PH

PROJECT NO: VSM

DATE: 7-2-09

NC CARPORTS AND GARAGES, LLC
309 S. DEPOT STREET
PILOT MOUNTAIN, NC 27041
30'-0" X 16'-0" ENCLOSED STRUCTURE

DATE: 7-2-09

SCALE: NTS

100155/191798/
JOB NO. 201765

REV. NO. 00000000

REV. 11A

REV. NO. SK-3

REV. 2

THIS DOCUMENT IS THE PROPERTY OF MOORE AND ASSOCIATES ENGINEERING AND CONSULTING, INC. REPRODUCTION, DISTRIBUTION, COPYING, OR OTHERWISE USE OF THIS DOCUMENT IS STRICTLY PROHIBITED AND ANY VIOLATION THEREOF MAY BE SUBJECT TO PROSECUTION AND PENALTY.

BOW EAVE RAFTER LEAN-TO OPTIONS

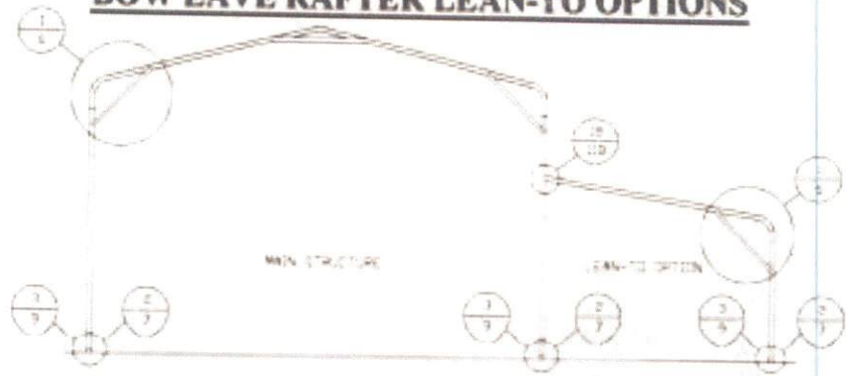

TYPICAL BOW EAVE RAFTER LEAN-TO OPTIONS FRAMING SECTION

SCALE: NTS
 MAXIMUM WIDTH OF SINGLE MEMBER LEAN-TO OPTION IS 12'-0"
 MAXIMUM WIDTH OF DOUBLE MEMBER LEAN-TO OPTION IS 16'-0"

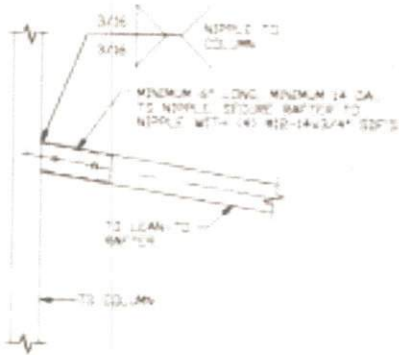

18A LEAN-TO RAFTER TO RAFTER POST CONNECTION DETAIL FOR WIDTHS $\le 12'-0''$
 SCALE: NTS

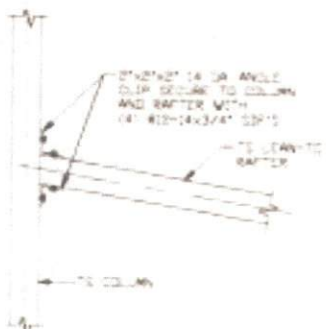

18B LEAN-TO RAFTER TO RAFTER POST CONNECTION DETAIL FOR WIDTHS $\le 12'-0''$
 SCALE: NTS

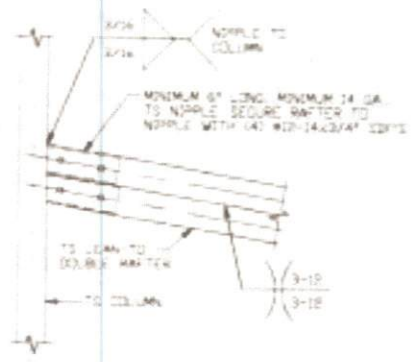

18C LEAN-TO RAFTER TO RAFTER POST CONNECTION DETAIL FOR WIDTHS $12'-0'' < TO \le 16'-0''$
 SCALE: NTS

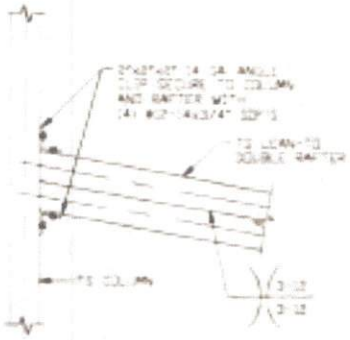

18D LEAN-TO RAFTER TO RAFTER POST CONNECTION DETAIL FOR WIDTHS $12'-0'' < TO \le 16'-0''$
 SCALE: NTS



MOORE AND ASSOCIATES ENGINEERING AND CONSULTING, INC.

DRAWN BY: JG	NC CARPORTS AND GARAGES, LLC 309 S. DEPOT STREET PILOT MOUNTAIN, NC 27041 30'-0" x 16'-0" ENCLOSED STRUCTURE		
CHECKED BY: PH	DATE: 7-2-20	SCALE: NTS	JOB NO: 201765
PROJECT NO: VSH	DATE: 7-2-20	SCALE: NTS	180328/191796/
BY: MOORE AND ASSOCIATES	SHT. 11B	DWG. NO: SK-3	REV. 2

THIS DOCUMENT IS THE PROPERTY OF MOORE AND ASSOCIATES ENGINEERING AND CONSULTING, INC. UNAUTHORIZED REPRODUCTION, COPIES, OR OTHERWISE USE OF THIS DOCUMENT IS STRICTLY PROHIBITED AND ANY VIOLATION THEREOF MAY BE PROSECUTED TO THE FULL EXTENT OF THE LAW.

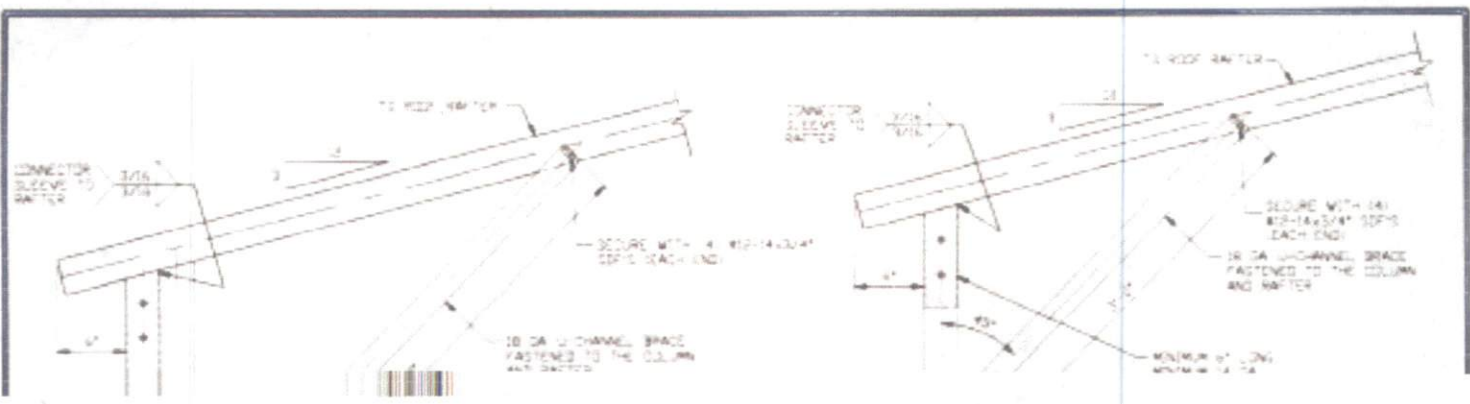

CONNECTOR SLEEVE TO RAFTER

TO ROOF RAFTER

SECURE WITH 4 #10-14x3/4\"/>

18 GA U-CANNEL BRACE FASTENED TO THE COLUMN AND RAFTER

CONNECTOR SLEEVE TO RAFTER

TO ROOF RAFTER

SECURE WITH (4) #10-14x3/4\"/>

18 GA U-CANNEL BRACE FASTENED TO THE COLUMN AND RAFTER

MINIMUM 1' LONG