

NOTICE TO CONTRACTOR  
All construction shall comply with current NC Building Codes and is subject to field inspection and verification.

APPROVED  
Limited building only review  
Permit holder responsible for full compliance with the code

08/17/2020

Converting Den to bedroom.  
Floor plan review only



# NORTH CAROLINA 40' SERIES PLAN 240.3174-R

## LOT 39 MASON POINTE - ELEVATION C

### SHEET INDEX

**PLAN #240.3174-R**

TS	TITLE SHEET
GN1	GENERAL NOTES
GN2	GENERAL NOTES
GN3	GENERAL NOTES
1.1	FIRST FLOOR PLAN
1.2	SECOND FLOOR PLAN
1.3	FIRST FLOOR AT CRAWL SPACE OPTION
1.4	FIRST FLOOR PLAN OPTIONS
1.5	FIRST FLOOR PLAN OPTIONS
1.6	SECOND FLOOR PLAN OPTIONS
2.1	SLAB INTERFACE PLAN 'A'
2.2	PARTIAL SLAB INTERFACE PLAN 'B', 'C', & 'D'
2.3	CRAWL SPACE PLAN 'A'
2.4	PARTIAL CRAWL SPACE PLAN 'B', 'C' & 'D'
3.A1	ROOF PLAN, FRONT & REAR ELEVATIONS 'A'
3.A2	LEFT & RIGHT ELEVATIONS 'A'
3.A3	PARTIAL FIRST FLOOR PLAN, FRONT ELEVATION AND PARTIAL LEFT AND RIGHT ELEVATIONS 'A' AT CRAWL SPACE
3.A4	FRONT ELEVATION 'A' AT OPTIONAL 9'-0" PLATE AT SLAB & CRAWL SPACE
3.B1	PARTIAL FIRST & SECOND FLOOR PLANS 'B'
3.B2	ROOF PLAN, FRONT & REAR ELEVATIONS 'B'
3.B3	LEFT & RIGHT ELEVATIONS 'B'
3.B4	PARTIAL FIRST FLOOR PLAN, FRONT ELEVATION AND PARTIAL LEFT AND RIGHT ELEVATIONS 'B' AT CRAWL SPACE
3.B5	FRONT ELEVATION 'B' AT OPTIONAL 9'-0" PLATE AT SLAB & CRAWL SPACE
3.C1	PARTIAL FIRST & SECOND FLOOR PLANS 'C'
3.C2	ROOF PLAN, FRONT & REAR ELEVATIONS 'C'
3.C3	LEFT & RIGHT ELEVATIONS 'C'
3.C4	PARTIAL FIRST FLOOR PLAN, FRONT ELEVATION AND PARTIAL LEFT AND RIGHT ELEVATIONS 'C' AT CRAWL SPACE
3.C5	FRONT ELEVATION 'C' AT OPTIONAL 9'-0" PLATE AT SLAB & CRAWL SPACE
3.D1	PARTIAL FIRST & SECOND FLOOR PLANS 'D'
3.D2	ROOF PLAN, FRONT & REAR ELEVATIONS 'D'
3.D3	LEFT & RIGHT ELEVATIONS 'D'
3.D4	PARTIAL FIRST FLOOR PLAN, FRONT ELEVATION AND PARTIAL LEFT AND RIGHT ELEVATIONS 'D' AT CRAWL SPACE
3.D5	FRONT ELEVATION 'D' AT OPTIONAL 9'-0" PLATE AT SLAB & CRAWL SPACE
4.1	INTERIOR ELEVATIONS
4.2	SECTIONS SLAB ON GRADE
4.3	SECTIONS CRAWL SPACE
5.1	FIRST FLOOR UTILITY PLAN
5.2	SECOND FLOOR UTILITY PLAN
5.3	FIRST FLOOR UTILITY PLAN OPTIONS
5.4	SECOND FLOOR UTILITY PLAN OPTIONS
5.5	SECOND FLOOR UTILITY PLAN OPTIONS
7.1	PARTIAL FLOOR PLAN, ELEVATIONS, CRAWL SPACE PLAN 'A/B/C/D' AT 12'x12' DECK
7.2	PARTIAL FLOOR PLAN, ELEVATIONS, CRAWL SPACE PLAN 'A/B/C/D' AT 21'x12' DECK
8.1	PARTIAL FLOOR PLAN, ROOF & ELEVATIONS W/ OPT. COVERED PATIO
8.2	PARTIAL FLOOR PLAN, ROOF & ELEVATIONS W/ OPT. EXTENDED COVERED PATIO
8.3	PARTIAL FLOOR PLAN, ROOF & ELEVATIONS W/ OPT. COVERED SCREENED PATIO
8.4	PARTIAL FLOOR PLAN, ROOF & ELEVATIONS W/ OPT. EXTENDED COVERED SCREENED PATIO
8.5	PARTIAL FLOOR PLAN, ELEVATIONS & SLAB INTERFACE PLAN 'A/B/C/D' AT SCREENED-IN 12'x12' COVERED DECK
8.6	PARTIAL FLOOR PLAN, ELEVATIONS & SLAB INTERFACE PLAN 'A/B/C/D' AT SCREENED-IN 21'x12' COVERED DECK

AD1	ARCHITECTURAL DETAILS
AD2	ARCHITECTURAL DETAILS
AD3	ARCHITECTURAL DETAILS
AD4	ARCHITECTURAL DETAILS
AD5	ARCHITECTURAL DETAILS
AD6	ARCHITECTURAL DETAILS
AD7	ARCHITECTURAL DETAILS
AD8	ARCHITECTURAL DETAILS



**NORTH CAROLINA  
40' SERIES**

KB HOME  
NORTH CAROLINA DIVISION  
4506 S. MIAMI BLVD.  
SUITE 180  
DURHAM, NC 27703  
TEL: (919) 768-7980  
FAX: (919) 544-2928

**2018 NORTH  
CAROLINA STATE  
BUILDING  
CODES**

- ISSUE DATE: 07/31/18  
PROJECT No.: 1350999:56  
DIVISION MGR.: MCP  
REVISIONS: 07/31/19
- 1 2018 CODE UPDATE NC1905NCP-01/23/19 MCP
  - 2 DIVISION REVISION NC1905NCP-02/28/19 MCP
  - 3 DIVISION REVISION NC1902NCP-04/22/19 MCP
  - 4 DIVISION REVISION NC1905NCP-07/31/19 FAB

### ABBREVIATIONS

ABV.	ABOVE	G.F.I.	GROUND-FAULT CIRCUIT INTERRUPTER	R.O.	ROUGH OPENING SHELF AND POLE
A/C	AIR CONDITIONING			S & P	SOLID CORE
ADJ.	ADJUSTABLE	G.I.	GALVANIZED IRON	S.C.	SMOKE DETECTOR
ALT	ALTERNATE	GL.	GLASS	S.D.	SECTION
AMP.	AMPERAGE	GYP. BD.	GYP. BOARD	S.H.	SINGLE HUNG
BD.	BOARD	H.C.	HOLLOW CORE	SHT.	SHEET
CL.	CENTER LINE	HDR.	HEADER	SHTG.	SHEATHING
CAB.	CABINET	HGT. / HT.	HEIGHT	SHWR.	SHOWER
CLS.	CEILING	H.H.	HEADER HEIGHT	SIM.	SIMILAR
CLR.	CLEAR	HS	HORIZONTAL SLIDER	SL.	SLIDING
CONC.	CONCRETE	I.L.O.	IN LIEU OF	SL. GL.	SLIDING GLASS
CPT.	CARPET	INSUL.	INSULATION	STD.	STANDARD
C.T.	CERAMIC TILE	INT.	INTERIOR	S.V.	SHEET VINYL
D.	DRYER	LAM.	LAMINATED	TEMP.	TEMPERED GLASS
DBL.	DOUBLE	LAV.	LAVATORY	THK.	THICK
D.G.	DUAL GLAZED	LUM.	LUMINOUS	T.O.C.	TOP OF CURB
DIA.	DIAMETER	M.C.	MEDICINE CABINET	T.O.P.	TOP OF PLATE
DIM.	DIMENSION	MFR.	MANUFACTURER	T.O.S.	TOP OF SLAB
DISP.	DISPOSAL	MIN.	MINIMUM	TYP.	TYPICAL
D.L.	DIVIDED LIGHT	MTD.	MOUNTED	U.N.O.	UNLESS NOTED OTHERWISE
DP.	DEEP	MTL.	METAL	V.P.	VAPOR PROOF
DR.	DOOR	N.I.C.	NOT IN CONTRACT	W.	WASHER
D.S.	DOWNSPOUT	N.T.S.	NOT TO SCALE	W.	WITH
DTL.	DETAIL	O/	OVER	WD.	WOOD
D.W.	DISHWASHER	O.C.	ON CENTER	WDW.	WINDOW
EA.	EACH	OPT.	OPTIONAL	WH	WATER HEATER
ELEV.	ELEVATION	O.S.A.	OUTSIDE AIR	WI.	WROUGHT IRON
EQ.	EQUAL	PL.	PLATE	WP.	WEATHER PROOF
EXH.	EXHAUST	PH.	PHONE		
EXT.	EXTERIOR	PLT.	PLATE		
FAU.	FORCED AIR UNIT	PLYWD.	PLYWOOD		
F.G./FX.	FIXED GLASS	FR.	PAIR		
F.G.	FUEL GAS	P.T.D.F.	PRESSURE TREATED DOUGLAS FIR		
FIN.	FINISH	R.	RISER		
FLR.	FLOOR	RAD.	RADIUS		
FLR. LINE	FLOOR LINE	R.A.G.	RETURN AIR GRILL		
FLUOR.	FLUORESCENT	REF.	REFRIGERATOR		
FR. DR.	FRENCH DOOR	RE/S	RE-SAWN		
F.M.C.	FLOOR MATERIAL CHANGE	REV.	REVERSE		
FTS.	FOOTING	RM.	ROOM		
GA.	GAUGE				
GAR. DISP.	GARBAGE DISPOSAL				

### ARCH. SYMBOLS

**BUILDING SECTION**  
SECTION INDICATOR  
SHEET NUMBER

**DETAIL REFERENCE**  
DETAIL NUMBER  
SHEET NUMBER

**KEYNOTE REFERENCE**  
REFERENCE NUMBER

**OFFSET REFERENCE**  
DIFFERENTIAL IN FLOOR LEVEL OR FINISH SURFACE

**REVISION REFERENCE**  
REVISION NUMBER  
REFER TO TITLE SHEET

### SCALE NOTE

IF BOX IS 1" SQ. THEN SCALE IS 1/4" = 1'-0"

IF BOX IS 1/2" SQ. THEN SCALE IS 1/8" = 1'-0"

### CONSULTANTS

**OWNER :**  
KB HOME  
NORTH CAROLINA DIVISION  
4506 S. MIAMI BLVD., SUITE 180  
DURHAM, NC 27703  
TEL: (919) 768-7980  
FAX: (919) 544-2928

**ARCHITECT**  
KB HOME  
5250 PACIFIC CONCOURSE DRIVE, SUITE 550  
LOS ANGELES, CA 90045  
TEL: (424) 244-3100  
FAX: (310) 241-2671

### SQUARE FOOTAGE

SQUARE FOOTAGE		PLAN 240.3174 PARTIN PLACE 2	
FIRST FLOOR AREA	1477	SQ. FT.	
SECOND FLOOR AREA	1647	SQ. FT.	
<b>TOTAL AREA</b>	<b>3124</b>	<b>SQ. FT.</b>	
GARAGE AREA	416	SQ. FT.	
PORCH AREA(S)			
ELEVATION 'A'	57	SQ. FT.	
ELEVATION 'B'	97	SQ. FT.	
ELEVATION 'C'	126	SQ. FT.	
ELEVATION 'D'	126	SQ. FT.	
OPTION (AREA) DEN/BDRM. 5/BA.3	101	SQ. FT.	
PATIO AREA(S)			
10'x10' COVERED	100	SQ. FT.	
10'x20' COVERED	200	SQ. FT.	
DECK AREA(S)			
OPEN 12'x12'	144	SQ. FT.	
OPEN 21'x12'	252	SQ. FT.	
SCREEN-IN 12'x12'	144	SQ. FT.	
SCREEN-IN 21'x12'	252	SQ. FT.	

### CODE INFORMATION

**APPLICABLE CODES:**  
2018 NORTH CAROLINA STATE BUILDING CODE; RESIDENTIAL CODE, INCLUDING REFERENCED CODES AND STANDARDS

**PROJECT DESCRIPTION:**  
2 STORY SINGLE FAMILY DETACHED RESIDENTIAL PLAN W/ 4 ELEVATIONS

**OCCUPANCY:**  
R3

**CONSTRUCTION TYPE:**  
V - B

**CODE ABBREVIATIONS**

N.C.-R.	NORTH CAROLINA RESIDENTIAL CODE
N.C.-B.	NORTH CAROLINA BUILDING CODE
N.C.-M.	NORTH CAROLINA MECHANICAL CODE
N.C.-P.	NORTH CAROLINA PLUMBING CODE
N.C.-F.	NORTH CAROLINA FUEL GAS CODE
N.C.-E.	NORTH CAROLINA ELECTRICAL CODE
N.C.-E.C.	NORTH CAROLINA ENERGY CODE
N.E.C.	NATIONAL ELECTRICAL CODE
I.C.B.O.	INTERNATIONAL CONFERENCE OF BUILDING OFFICIALS
A.S.T.M.	AMERICAN SOCIETY FOR TESTING MATERIALS
N.F.P.A.	NATIONAL FIRE PROTECTION ASSOCIATION
ANSI.	AMERICAN NATIONAL STANDARDS INSTITUTE
I.E.C.C.	INTERNATIONAL ENERGY CONSERVATION CODE
I.C.C.	INTERNATIONAL CODE COUNCIL UNDERWRITERS LABORATORIES, INC.
U.L.	

### REVISION LIST

DELTA	DATE	SHEETS REVISED	LOG NUMBER
1	01/25/19	TS.	NC1905NCP
2	02/28/19	AI.1- AI.7, 3.A1,3.A2, 3.B1, 3.B2, 3.B3, 3.C1, 3.D1.	NC1905NCP
3	04/22/19	3.B1	NC1902NCP
4	07/31/19	ALL	NC1905NCP

FOR INTERNAL USE ONLY

REVISION BY:	
1.	
2.	
3.	
4.	
5.	
6.	

PLAN:  
**240.3174-R**  
SHEET:  
**TS**

**SPEC. LEVEL 1  
RALEIGH-DURHAM  
40' SERIES**

These designs and drawings are CONFIDENTIAL and the exclusive property of KB Home Corporation and are not to be disclosed without the express permission of KB Home Corporation. Copyright 2014 © KB Home Corporation, all rights reserved.









**NORTH CAROLINA  
40' SERIES**

KB HOME  
NORTH CAROLINA DIVISION  
4506 S. MIAMI BLVD.  
SUITE 180  
DURHAM, NC 27703  
TEL: (919) 768-7980  
FAX: (919) 544-2928

**2018 NORTH  
CAROLINA STATE  
BUILDING  
CODES**

ISSUE DATE: 07/31/18  
PROJECT No.: 1350999-56  
DIVISION MGR.: MCP  
REVISIONS: 07/31/19

- 1 2018 CODE UPDATE NC1905NCP- 01/23/19 MCP
- 2 DIVISION REVISION NC1905NCP- 02/22/19 MCP
- 3 DIVISION REVISION NC1902NCP- 04/22/19 MCP
- 4 DIVISION REVISION NC1905NCP- 07/31/19 FAB

FOR INTERNAL USE ONLY	
REVISION NO.	DATE
1	
2	
3	
4	

PLAN:  
**240.3174-R**  
SHEET:  
**1.1**

**SPEC. LEVEL 1  
RALEIGH-DURHAM  
40' SERIES**

- # FLOOR PLAN NOTES**
- SINK WITH GARBAGE DISPOSAL - VERIFY DIMENSIONS WITH MANUFACTURER SPEC'S.
  - DISHWASHER - PROVIDE SURFACE MOUNT AIR GAP VERIFY DIMENSIONS WITH MANUFACTURER SPEC'S.
  - SLIDE-IN RANGE/ OVEN COMBINATION W/ BUILT-IN LIGHT & FAN (VENT TO OUTSIDE AIR) - VERIFY WITH MANUFACTURER SPEC'S.
  - 36" COOKTOP - W/ BUILT-IN HOOD W/LIGHT & FAN, (VENT TO OUTSIDE AIR) - CABINET MOUNTED MICROWAVE INCLUDED OVEN WITH VENT - VERIFY WITH MANUFACTURER SPEC'S.
  - 34" CLEAR REFRIGERATOR SPACE - PROVIDE PLUMBING FOR ICE/MAKER (RECESSED IN WALL).
  - DOUBLE OVEN - VERIFY WITH MANUFACTURER SPEC'S.
  - BASE CABINETS - REFER TO INTERIOR ELEVATIONS
  - UPPER CABINETS - REFER TO INTERIOR ELEVATIONS
  - PANTRY - SHELVES PER SPEC
  - ISLAND CABINET - REFER TO INTERIOR ELEVATIONS
  - TUB/SHOWER COMBINATION WITH T2' FIBERGLASS ENCLOSURE (NON-ABSORBENT) VERIFY DIMENSIONS WITH MFR'S SPEC'S.
  - OVAL TUB - VERIFY DIMENSIONS WITH MANUFACTURER SPEC'S.
  - SHOWER PAN WITH MAINSCOT TO 84" - VERIFY DIMENSIONS WITH MANUFACTURER SPEC'S.
  - SHATTERPROOF (TEMPERED) GLASS SHOWER ENCLOSURE
  - TOWEL BAR
  - NOT USED
  - TOILET PAPER HOLDER
  - EXTEND VANITY - REFER TO INTERIOR ELEVATIONS
  - OPTIONAL SINK
  - PROVIDE WATER AND WASTE FOR WASHER (WASHER CONTROL VALVES) (RECESSED IN WALL)
  - DRYER VENT
  - NOT USED
  - FREE STANDING LAUNDRY SINK - VERIFY DIMENSIONS WITH MFR'S SPEC'S.
  - ELECTRIC WATER HEATER - LOCATE ON 18" HIGH FRAMED PLATFORM
  - TEMPERATURE AND PRESSURE RELIEF VALVE DRAIN TO EXTERIOR - MIN. 6" ABOVE & MAX. 24" ABOVE GRADE
  - NOT USED
  - NOT USED
  - PRE-MFR. METAL GAS APPLIANCE FIREPLACE INSTALLED PER MANUFACTURER'S INSTRUCTIONS
  - NON-COMBUSTIBLE HEARTH MATERIAL
  - ROUTE OF FIREPLACE 'B' VENT FROM BELOW - PROVIDE O.S.B. SHAFT
  - +36" GUARD WALL DETAIL 84/AD5 OR 86/AD5
  - +34" - +38" HIGH HANDRAIL DETAIL 83/AD5
  - COATS WITH SHELF & POLE - DETAIL T3/AD4
  - LINEN - SHELVES PER SPEC
  - WARDROBE WITH SHELF & POLE - DETAIL T3/AD4 U.N.O.
  - MEDIA NICHE - REFER TO INTERIOR ELEVATIONS
  - FLAT SOFFIT - REFER TO PLAN OR ELEVATIONS FOR HEIGHT
  - NOT USED
  - LINE OF CEILING BREAK
  - INTERIOR SHELF - REFER TO PLAN OR INT. ELEV. FOR HGT.
  - LOW WALL - REFER TO PLAN FOR HEIGHT - DETAIL T2/AD4
  - LOCATION OF PLUMBING WASTE DROP FROM ABOVE
  - 2x6 WALL
  - 2x6 BALLOON FRAMED WALL - REFER TO STRUCTURAL
  - DOUBLE 2x4 WALL
  - LINE OF FLOOR ABOVE
  - LINE OF FLOOR BELOW
  - EXTERIOR RAIL
  - F.A.U. VENT TO OUTSIDE AIR
  - 22"x54" ATTIC ACCESS W/ STAIRS
  - F.A.U. IN ATTIC - PROVIDE MIN. 22"x30" ATTIC ACCESS PANEL - PROVIDE FUEL GAS. REFER TO UTILITY PLAN DETAIL 88/AD5
  - DUCT CHASE - DETAIL 84 & 90/AD5 - REFER TO MECH. PLAN
  - RETURN AIR GRILL (R.A.G.) - REFER TO MECHANICAL PLAN
  - 1/2" GYPSUM BOARD ON CEILING AND WALLS AT USEABLE SPACE UNDER STAIRS
  - THE GARAGE SHALL BE SEPARATED FROM THE RESIDENCE AND ITS ATTIC AREA BY NOT LESS THAN 2" GYPSUM BOARD APPLIED TO THE GARAGE SIDE
  - SEPARATION BETWEEN SECOND FLOOR AND GARAGE CEILING, PROVIDE (1) LAYER OF 7" TYPE 'X' GYPSUM BOARD, WALLS SUPPORTING SECOND FLOOR AND GARAGE CEILING, PROVIDE (1) LAYER OF 7" GYPSUM BOARD
  - EXTERIOR SHELF - REFER TO ELEV. FOR HEIGHT
  - NOT USED
  - NOT USED
  - SECTIONAL GARAGE DOOR - VERIFY WINDOW OPTION
  - NOT USED
  - DRAFTSTOP REQUIRED IN FLOOR / CEILING SPACES EXCEEDING 1000 SQUARE FEET. DIVIDED SPACES MUST BE ROUGHLY EQUAL
  - OPENINGS BETWEEN GARAGE AND HOUSE SHALL BE EQUIPPED WITH SOLID WOOD DOORS NOT LESS THAN 1 3/8" THICK, OR SHALL BE 20-MINUTE FIRE RATED. DOORS SHALL BE WEATHERSTRIPPED
- NOTE:  
FOR ALL PLAN OPTIONS REFER TO BASIC PLAN FOR INFORMATION NOT SHOWN HERE.

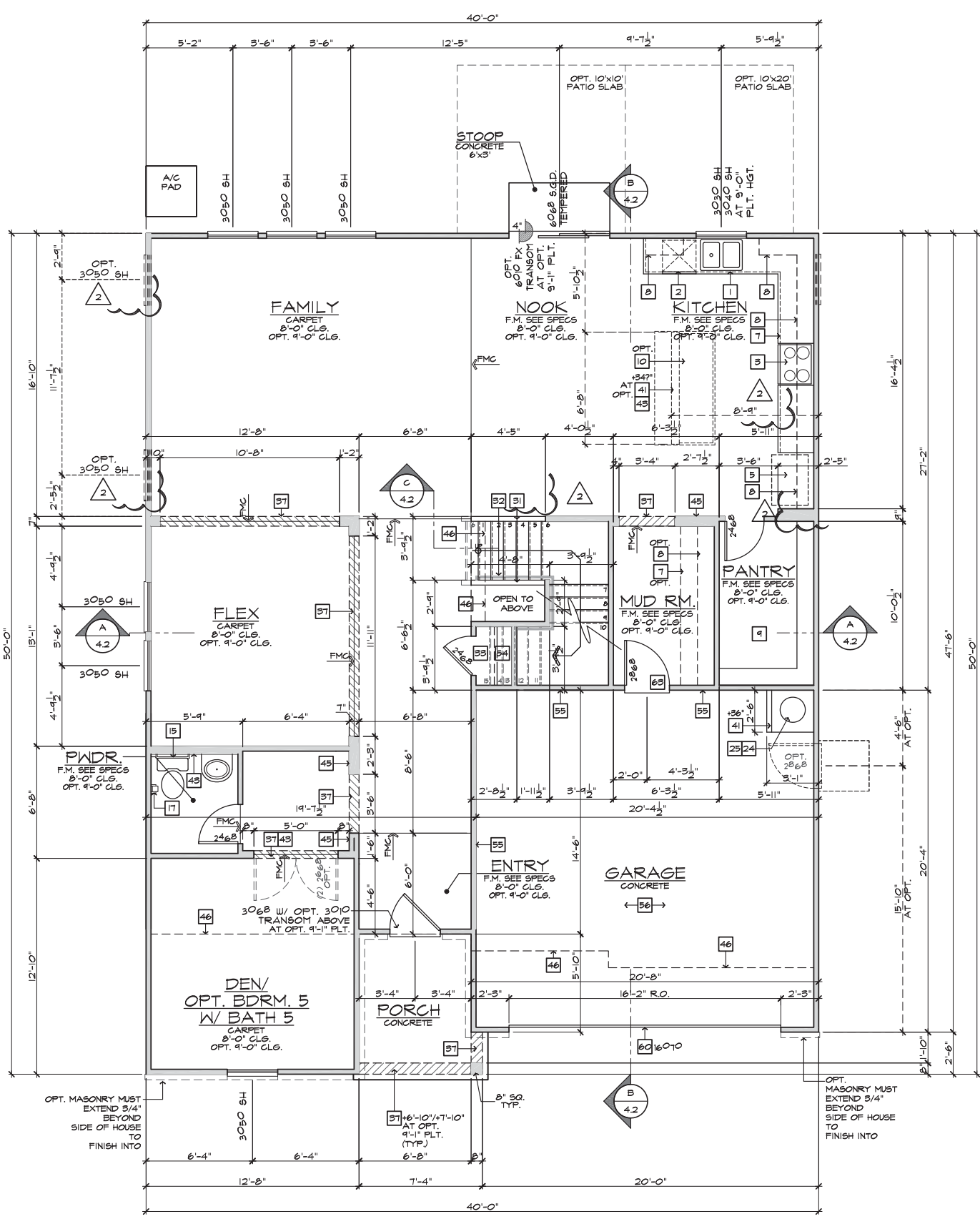

**FIRST FLOOR PLAN 'A'**  
SCALE 1/4"=1'-0" (22"x34") - 1/8"=1'-0" (11"x17")  
BASIC PLAN

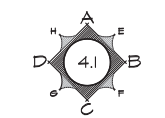

**INTERIOR KEY**

SQUARE FOOTAGE		
PLAN 2403174 PARTIN PLACE 2		
FIRST FLOOR AREA	1477	SQ. FT.
SECOND FLOOR AREA	1647	SQ. FT.
<b>TOTAL AREA</b>	<b>3174</b>	<b>SQ. FT.</b>
GARAGE AREA	416	SQ. FT.
PORCH AREA(S)		
ELEVATION 'A'	57	SQ. FT.
ELEVATION 'B'	91	SQ. FT.
ELEVATION 'C'	126	SQ. FT.
ELEVATION 'D'	126	SQ. FT.
OPTION (AREA) DEN/BDRM. 5/BAS	101	SQ. FT.
PATIO AREA(S)		
10'x10' COVERED	100	SQ. FT.
10'x20' COVERED	200	SQ. FT.
DECK AREA(S)		
OPEN 12'x12'	144	SQ. FT.
OPEN 21'x12'	252	SQ. FT.
SCREEN-IN 12'x12'	144	SQ. FT.
SCREEN-IN 21'x12'	252	SQ. FT.

**PLATE NOTES**

**8'-1" PLATE NOTES**

WINDOW HEADER HEIGHT:	6'-8" U.N.O.
2ND FLOOR WINDOW HDR. HEIGHT:	7'-0" U.N.O.
ENTRY DOOR HEIGHT:	6'-8" U.N.O.
SLIDING GLASS DOOR HEIGHT:	6'-8" (TEMP.)
INTERIOR SOFFIT HEIGHT:	7'-4" U.N.O.
INTERIOR DOOR HEIGHT:	6'-8" U.N.O.

**9'-1" PLATE NOTES**

WINDOW HEADER HEIGHT 1st OR 2nd:	7'-8" U.N.O.
40'0 WINDOW OVER TUB HDR. HGT.:	8'-4" U.N.O.
ENTRY DOOR HEIGHT:	6'-8" U.N.O.
SLIDING GLASS DOOR HEIGHT:	6'-8" (TEMP.)
INTERIOR SOFFIT HEIGHT:	8'-0" U.N.O.
TRAY CEILING:	T2' DROP U.N.O.
INTERIOR DOOR HEIGHT:	6'-8" U.N.O.

**STAIR DATA NOTES**

<b>FIRST FLOOR WITH 8'-1" PLATE HEIGHT:</b>
14" DEEP T.J.I. FLOOR JOISTS WITH 3/4" T&G DECKING.
14 TREADS AT 10" EACH
15 RISERS AT 7-7/16" EACH
<b>FIRST FLOOR WITH 9'-1" PLATE HEIGHT:</b>
14" DEEP T.J.I. FLOOR JOISTS WITH 3/4" T&G DECKING.
15 TREADS AT 10" EACH
16 RISERS AT 7-3/4" EACH

**GENERAL PLAN NOTES**

ALL CEILING HEIGHTS PER SECTION AND ELEVATION PLATE HEIGHTS, U.N.O.  
ALL INTERIOR DOORS TO BE HOLLOW CORE 1 3/8" THICK, U.N.O. (REFER TO PLAN FOR SIZE)  
ALL GARAGE SERVICE DOORS TO BE HOLLOW CORE EXTERIOR GRADE (REFER TO PLAN FOR SIZE)  
ALL HOUSE TO GARAGE DOORS TO BE 20-MINUTE FIRE-RATED (REFER TO PLAN FOR SIZE)  
ALL ENTRY DOORS AND EXTERIOR FRENCH DOORS TO BE SOLID CORE 1 3/4" THICK (REFER TO PLAN FOR SIZE)  
ALL FLOOR MATERIAL CHANGES TO OCCUR AT CENTER OF DOOR JAMBS, U.N.O.

These designs and drawings are CONFIDENTIAL and the exclusive property of KB Home Corporation and are not to be disclosed without the express permission of KB Home Corporation. Copyright 2014 © KB Home Corporation, all rights reserved.



**NORTH CAROLINA  
40' SERIES**

KB HOME  
NORTH CAROLINA DIVISION

4506 S. MIAMI BLVD.  
SUITE 180  
DURHAM, NC 27703  
TEL: (919) 768-7980  
FAX: (919) 544-2928

**2018 NORTH  
CAROLINA STATE  
BUILDING  
CODES**

ISSUE DATE: 07/31/18  
PROJECT No.: 1350999:56  
DIVISION MGR.: MCP  
REVISIONS: 07/31/19

- 1 2018 CODE UPDATE NC19055NCP- 01/23/19 MCP
- 2 DIVISION REVISION NC19055NCP- 02/22/19 MCP
- 3 DIVISION REVISION NC19029NCP- 04/22/19 MCP
- 4 DIVISION REVISION NC19055NCP- 07/31/19 FAB

FOR INTERNAL USE ONLY	
REVISION NO.	DATE
1	
2	
3	
4	
5	
6	

PLAN:  
**240.3174-R**

SHEET:  
**1.2**

**SPEC. LEVEL 1  
RALEIGH-DURHAM  
40' SERIES**

- # FLOOR PLAN NOTES**
- SINK WITH GARBAGE DISPOSAL - VERIFY DIMENSIONS WITH MANUFACTURER SPEC'S.
  - DISHWASHER - PROVIDE SURFACE MOUNT AIR GAP VERIFY DIMENSIONS WITH MANUFACTURER SPEC'S.
  - SLIDE-IN RANGE/ OVEN COMBINATION W/ BUILT-IN LIGHT & FAN (VENT TO OUTSIDE AIR) - VERIFY WITH MANUFACTURER SPEC'S.
  - 36" COOKTOP - W/ BUILT-IN HOOD W/LIGHT & FAN, (VENT TO OUTSIDE AIR) - CABINET MOUNTED MICROWAVE INCLUDED OVEN WITH VENT - VERIFY WITH MANUFACTURER SPEC'S.
  - 34" CLEAR REFRIGERATOR SPACE - PROVIDE PLUMBING FOR ICEMAKER (RECESSED IN WALL).
  - DOUBLE OVEN - VERIFY WITH MANUFACTURER SPEC'S.
  - BASE CABINETS - REFER TO INTERIOR ELEVATIONS
  - UPPER CABINETS - REFER TO INTERIOR ELEVATIONS
  - PANTRY - SHELVES PER SPEC
  - ISLAND CABINET - REFER TO INTERIOR ELEVATIONS
  - TUB/SHOWER COMBINATION WITH 12" FIBERGLASS ENCLOSURE (NON-ABSORBENT) VERIFY DIMENSIONS WITH MFR'S SPEC'S.
  - OVAL TUB - VERIFY DIMENSIONS WITH MANUFACTURER SPEC'S.
  - SHOWER PAN WITH MAINSCOT TO 84" - VERIFY DIMENSIONS WITH MANUFACTURER SPEC'S.
  - SHATTERPROOF (TEMPERED) GLASS SHOWER ENCLOSURE
  - TOKEL BAR
  - NOT USED
  - TOILET PAPER HOLDER
  - EXTEND VANITY - REFER TO INTERIOR ELEVATIONS
  - OPTIONAL SINK
  - PROVIDE WATER AND WASTE FOR WASHER (WASHER CONTROL VALVES) (RECESSED IN WALL)
  - DRYER VENT
  - NOT USED
  - FREE STANDING LAUNDRY SINK - VERIFY DIMENSIONS WITH MFR'S SPEC'S.
  - ELECTRIC WATER HEATER - LOCATE ON 18" HIGH FRAMED PLATFORM
  - TEMPERATURE AND PRESSURE RELIEF VALVE DRAIN TO EXTERIOR - MIN. 6" ABOVE & MAX. 24" ABOVE GRADE
  - NOT USED
  - NOT USED
  - PRE-MFR. METAL GAS APPLIANCE FIREPLACE INSTALLED PER MANUFACTURERS INSTRUCTIONS
  - NON-COMBUSTIBLE HEARTH MATERIAL
  - ROUTE OF FIREPLACE "B" VENT FROM BELOW - PROVIDE O.S.B. SHAFT
  - +36" GUARD WALL DETAIL 84/AD5 OR 86/AD5
  - +34" - +38" HIGH HANDRAIL DETAIL 83/AD5
  - COATS WITH SHELF & POLE - DETAIL T3/AD4
  - LINEN - SHELVES PER SPEC
  - WARDROBE WITH SHELF & POLE - DETAIL T3/AD4 U.N.O.
  - MEDIA NICHE - REFER TO INTERIOR ELEVATIONS
  - FLAT SOFFIT - REFER TO PLAN OR ELEVATIONS FOR HEIGHT
  - NOT USED
  - LINE OF CEILING BREAK
  - INTERIOR SHELF - REFER TO PLAN OR INT. ELEV. FOR HGT.
  - LOW WALL - REFER TO PLAN FOR HEIGHT - DETAIL T2/AD4
  - LOCATION OF PLUMBING WASTE DROP FROM ABOVE
  - 2x6 WALL
  - 2x6 BALLOON FRAMED WALL - REFER TO STRUCTURAL
  - DOUBLE 2x4 WALL
  - LINE OF FLOOR ABOVE
  - LINE OF FLOOR BELOW
  - EXTERIOR RAIL
  - F.A.U. VENT TO OUTSIDE AIR
  - 22"x54" ATTIC ACCESS W/ STAIRS
  - F.A.U. IN ATTIC - PROVIDE MIN. 22"x30" ATTIC ACCESS PANEL - PROVIDE FUEL GAS. REFER TO UTILITY PLAN DETAIL 88/AD5
  - DUCT CHASE - DETAIL 89 & 90/AD5 - REFER TO MECH. PLAN
  - RETURN AIR GRILL (R.A.G.) - REFER TO MECHANICAL PLAN
  - 1/2" GYPSUM BOARD ON CEILING AND WALLS AT USEABLE SPACE UNDER STAIRS
  - THE GARAGE SHALL BE SEPARATED FROM THE RESIDENCE AND ITS ATTIC AREA BY NOT LESS THAN 2" GYPSUM BOARD APPLIED TO THE GARAGE SIDE
  - SEPARATION BETWEEN SECOND FLOOR AND GARAGE CEILING, PROVIDE (1) LAYER OF 2" TYPE "X" GYPSUM BOARD, WALLS SUPPORTING SECOND FLOOR AND GARAGE CEILING, PROVIDE (1) LAYER OF 2" GYPSUM BOARD
  - EXTERIOR SHELF - REFER TO ELEV. FOR HEIGHT
  - NOT USED
  - NOT USED
  - SECTIONAL GARAGE DOOR - VERIFY WINDOW OPTION
  - NOT USED
  - DRAFTSTOP REQUIRED IN FLOOR / CEILING SPACES EXCEEDING 1000 SQUARE FEET. DIVIDED SPACES MUST BE ROUGHLY EQUAL.
  - OPENINGS BETWEEN GARAGE AND HOUSE SHALL BE EQUIPPED WITH SOLID WOOD DOORS NOT LESS THAN 1 3/8" INCH THICK, OR SHALL BE 20-MINUTE FIRE RATED. DOORS SHALL BE WEATHERSTRIPPED
- NOTE:  
FOR ALL PLAN OPTIONS REFER TO BASIC PLAN FOR INFORMATION NOT SHOWN HERE.

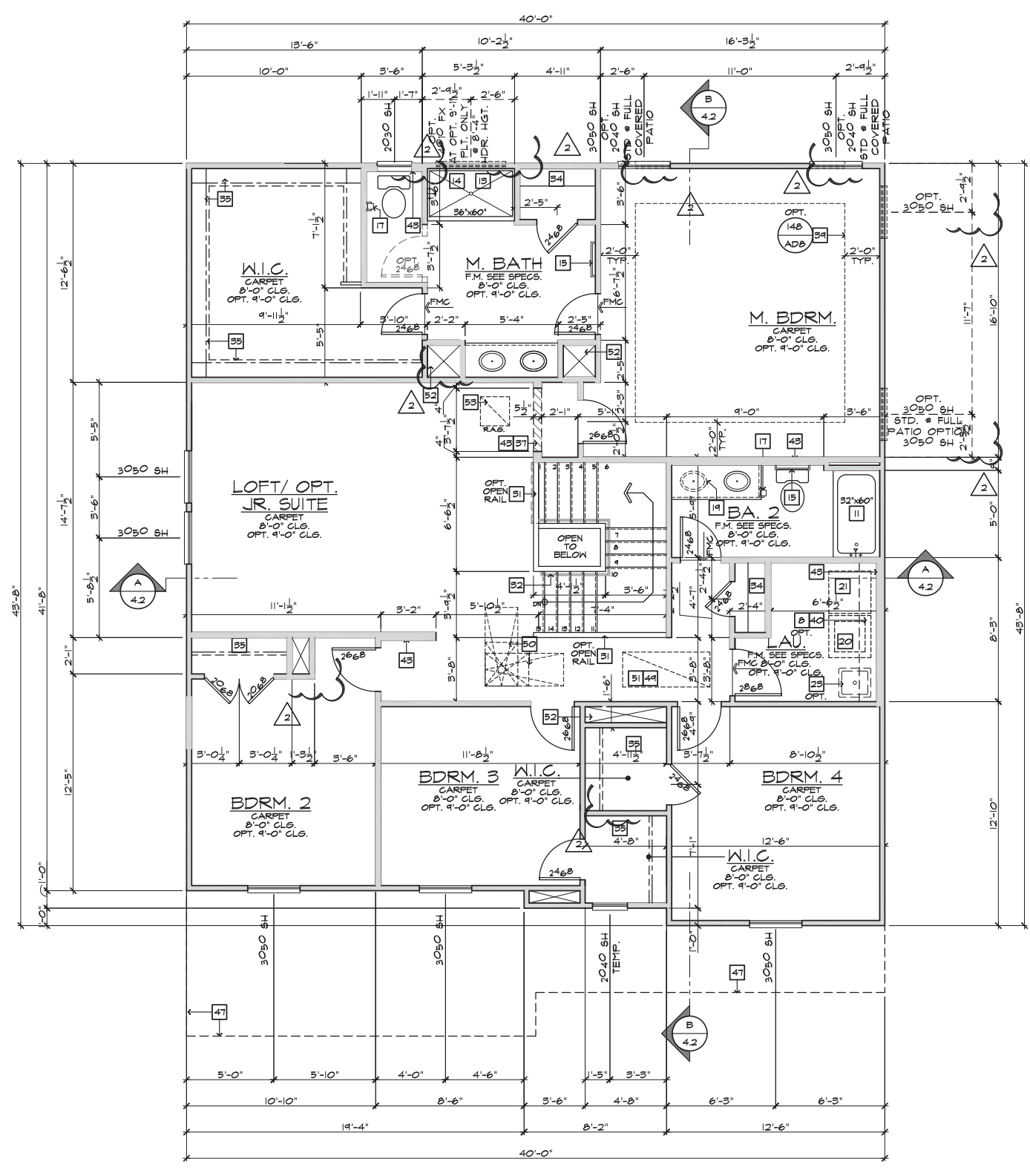

**SECOND FLOOR PLAN 'A'**  
SCALE 1/4"=1'-0" (22'x34") - 1/8"=1'-0" (11'x17")

BASIC PLAN

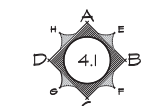

**INTERIOR KEY**

PLATE NOTES	
<b>8'-1" PLATE NOTES</b>	
WINDOW HEADER HEIGHT:	6'-8" U.N.O.
2ND FLOOR WINDOW HDR. HEIGHT:	7'-0" U.N.O.
ENTRY DOOR HEIGHT:	6'-8" U.N.O.
SLIDING GLASS DOOR HEIGHT:	6'-8" (TEMP.)
INTERIOR SOFFIT HEIGHT:	7'-4" U.N.O.
INTERIOR DOOR HEIGHT:	6'-8" U.N.O.
<b>9'-1" PLATE NOTES</b>	
WINDOW HEADER HEIGHT 1st OR 2nd:	7'-8" U.N.O.
4010 WINDOW OVER TUB HDR. HGT.:	8'-4" U.N.O.
ENTRY DOOR HEIGHT:	6'-8" U.N.O.
SLIDING GLASS DOOR HEIGHT:	6'-8" (TEMP.)
INTERIOR SOFFIT HEIGHT:	8'-0" U.N.O.
TRAY CEILING:	T3 DROP U.N.O.
INTERIOR DOOR HEIGHT:	6'-8" U.N.O.

STAIR DATA NOTES	
<b>FIRST FLOOR WITH 8'-1" PLATE HEIGHT:</b>	
14" DEEP T.J.I. FLOOR JOISTS WITH 3/4" T&G DECKING.	
14" TREADS AT 10" EACH	
15 RISERS AT 7-11/16" EACH	
<b>FIRST FLOOR WITH 9'-1" PLATE HEIGHT:</b>	
14" DEEP T.J.I. FLOOR JOISTS WITH 3/4" T&G DECKING.	
15 TREADS AT 10" EACH	
16 RISERS AT 7-3/4" EACH	

GENERAL PLAN NOTES	
ALL CEILING HEIGHTS PER SECTION AND ELEVATION PLATE HEIGHTS, U.N.O.	
ALL INTERIOR DOORS TO BE HOLLOW CORE 1 3/8" THICK, U.N.O. (REFER TO PLAN FOR SIZE)	
ALL GARAGE SERVICE DOORS TO BE HOLLOW CORE EXTERIOR GRADE (REFER TO PLAN FOR SIZE)	
ALL HOUSE TO GARAGE DOORS TO BE 20-MINUTE FIRE-RATED (REFER TO PLAN FOR SIZE)	
ALL ENTRY DOORS AND EXTERIOR FRENCH DOORS TO BE SOLID CORE 1 3/4" THICK (REFER TO PLAN FOR SIZE)	
ALL FLOOR MATERIAL CHANGES TO OCCUR AT CENTER OF DOOR JAMBS, U.N.O.	

These designs and drawings are CONFIDENTIAL and the exclusive property of KB Home Corporation, and are not to be disclosed without the express permission of KB Home Corporation. Copyright 2014 © KB Home Corporation, all rights reserved.



**NORTH CAROLINA  
40' SERIES**

KB HOME  
NORTH CAROLINA DIVISION  
4506 S. MIAMI BLVD.  
SUITE 180  
DURHAM, NC 27703  
TEL: (919) 768-7980  
FAX: (919) 544-2928

**2018 NORTH  
CAROLINA STATE  
BUILDING  
CODES**

ISSUE DATE: 07/31/18  
PROJECT No.: 1350999:56  
DIVISION MGR.: MCP  
REVISIONS: 07/31/19

- 1 2018 CODE UPDATE  
NC19055NCP- 01/23/19 MCP
- 2 DIVISION REVISION  
NC19055NCP- 02/22/19 MCP
- 3 DIVISION REVISION  
NC19029NCP- 04/22/19 MCP
- 4 DIVISION REVISION  
NC19055NCP- 07/31/19 FAB

FOR INTERNAL USE ONLY	
REVISED BY:	
1	
2	
3	
4	
5	
6	

PLAN:  
**240.3174-R**  
SHEET:  
**1.4**

**SPEC. LEVEL 1  
RALEIGH-DURHAM  
40' SERIES**

- # FLOOR PLAN NOTES**
- SINK WITH GARBAGE DISPOSAL - VERIFY DIMENSIONS WITH MANUFACTURER SPECS.
  - DISHWASHER - PROVIDE SURFACE MOUNT AIR GAP VERIFY DIMENSIONS WITH MANUFACTURER SPECS.
  - SLIDE-IN RANGE/ OVEN COMBINATION W/ BUILT-IN LIGHT & FAN (VENT TO OUTSIDE AIR) - VERIFY WITH MANUFACTURER SPECS.
  - 36" COOKTOP - W/ BUILT-IN HOOD W/LIGHT & FAN, (VENT TO OUTSIDE AIR) - CABINET MOUNTED MICROWAVE INCLUDED OVEN WITH VENT - VERIFY WITH MANUFACTURER SPECS.
  - 34" CLEAR REFRIGERATOR SPACE - PROVIDE PLUMBING FOR ICEMAKER (RECESSED IN WALL).
  - DOUBLE OVEN - VERIFY WITH MANUFACTURER SPECS.
  - BASE CABINETS - REFER TO INTERIOR ELEVATIONS
  - UPPER CABINETS - REFER TO INTERIOR ELEVATIONS
  - PANTRY - SHELVES PER SPEC
  - ISLAND CABINET - REFER TO INTERIOR ELEVATIONS
  - TUB/SHOWER COMBINATION WITH T2" FIBERGLASS ENCLOSURE (NON-ABSORBENT) VERIFY DIMENSIONS WITH MFR'S SPECS.
  - OVAL TUB - VERIFY DIMENSIONS WITH MANUFACTURER SPECS.
  - SHOWER PAN WITH MAINSCOT TO 84" - VERIFY DIMENSIONS WITH MANUFACTURER SPECS.
  - SHATTERPROOF (TEMPERED) GLASS SHOWER ENCLOSURE
  - TOWEL BAR
  - NOT USED
  - TOILET PAPER HOLDER
  - EXTEND VANITY - REFER TO INTERIOR ELEVATIONS
  - OPTIONAL SINK
  - PROVIDE WATER AND WASTE FOR WASHER (WASHER CONTROL VALVES) (RECESSED IN WALL)
  - DRYER VENT
  - NOT USED
  - FREE STANDING LAUNDRY SINK - VERIFY DIMENSIONS WITH MFR'S SPECS.
  - ELECTRIC WATER HEATER - LOCATE ON 18" HIGH FRAMED PLATFORM
  - TEMPERATURE AND PRESSURE RELIEF VALVE DRAIN TO EXTERIOR - MIN. 6" ABOVE & MAX. 24" ABOVE GRADE
  - NOT USED
  - NOT USED
  - PRE-MFR. METAL GAS APPLIANCE FIREPLACE INSTALLED PER MANUFACTURERS INSTRUCTIONS
  - NON-COMBUSTIBLE HEARTH MATERIAL
  - ROUTE OF FIREPLACE "B" VENT FROM BELOW - PROVIDE O.S.B. SHAFT
  - +36" GUARD WALL DETAIL 84/AD5 OR 86/AD5
  - +34" - +38" HIGH HANDRAIL DETAIL 83/AD5
  - COATS WITH SHELF & POLE - DETAIL T3/AD4
  - LINEN - SHELVES PER SPEC
  - WARDROBE WITH SHELF & POLE - DETAIL T3/AD4 U.N.O.
  - MEDIA NICHE - REFER TO INTERIOR ELEVATIONS
  - FLAT SOFFIT - REFER TO PLAN OR ELEVATIONS FOR HEIGHT
  - NOT USED
  - LINE OF CEILING BREAK
  - INTERIOR SHELF - REFER TO PLAN OR INT. ELEV. FOR HGT.
  - LOW WALL - REFER TO PLAN FOR HEIGHT - DETAIL T2/AD4
  - LOCATION OF PLUMBING WASTE DROP FROM ABOVE
  - 2x6 WALL
  - 2x6 BALLOON FRAMED WALL - REFER TO STRUCTURAL
  - DOUBLE 2x4 WALL
  - LINE OF FLOOR ABOVE
  - LINE OF FLOOR BELOW
  - EXTERIOR RAIL
  - F.A.U. VENT TO OUTSIDE AIR
  - 22"x54" ATTIC ACCESS W/ STAIRS
  - F.A.U. IN ATTIC - PROVIDE MIN. 22"x30" ATTIC ACCESS PANEL - PROVIDE FUEL GAS. REFER TO UTILITY PLAN DETAIL 88/AD5
  - DUCT CHASE - DETAIL 89 & 90/AD5 - REFER TO MECH. PLAN
  - RETURN AIR GRILL (R.A.G.) - REFER TO MECHANICAL PLAN
  - 1/2" GYPSUM BOARD ON CEILING AND WALLS AT USEABLE SPACE UNDER STAIRS
  - THE GARAGE SHALL BE SEPARATED FROM THE RESIDENCE AND ITS ATTIC AREA BY NOT LESS THAN 2" GYPSUM BOARD APPLIED TO THE GARAGE SIDE
  - SEPARATION BETWEEN SECOND FLOOR AND GARAGE CEILING, PROVIDE (1) LAYER OF 7" TYPE "X" GYPSUM BOARD, WALLS SUPPORTING SECOND FLOOR AND GARAGE CEILING, PROVIDE (1) LAYER OF 7" GYPSUM BOARD
  - EXTERIOR SHELF - REFER TO ELEV. FOR HEIGHT
  - NOT USED
  - NOT USED
  - SECTIONAL GARAGE DOOR - VERIFY WINDOW OPTION
  - NOT USED
  - DRAFTSTOP REQUIRED IN FLOOR / CEILING SPACES EXCEEDING 1000 SQUARE FEET. DIVIDED SPACES MUST BE ROUGHLY EQUAL.
  - OPENINGS BETWEEN GARAGE AND HOUSE SHALL BE EQUIPPED WITH SOLID WOOD DOORS NOT LESS THAN 1 3/8-INCH THICK, OR SHALL BE 20-MINUTE FIRE RATED. DOORS SHALL BE WEATHERSTRIPPED
- NOTE:  
FOR ALL PLAN OPTIONS REFER TO BASIC PLAN FOR INFORMATION NOT SHOWN HERE.

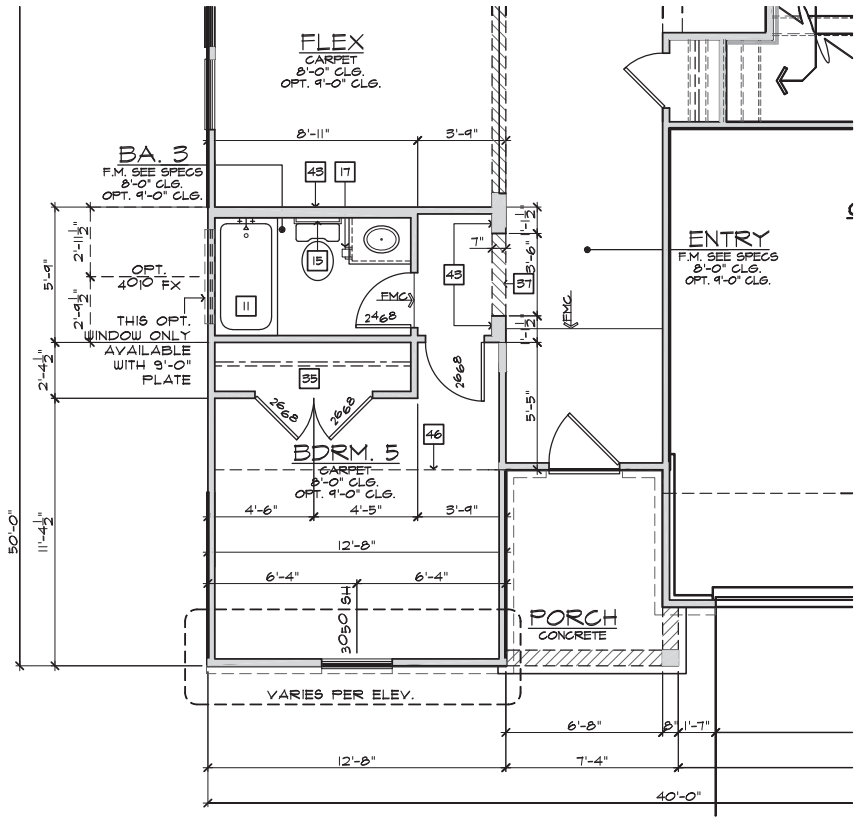
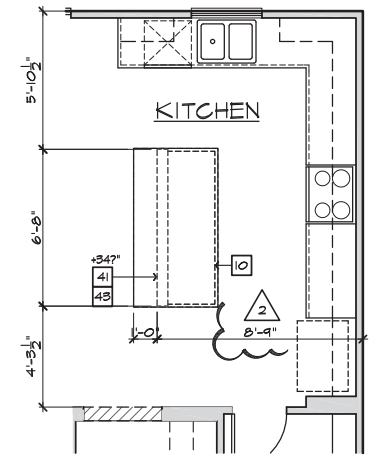
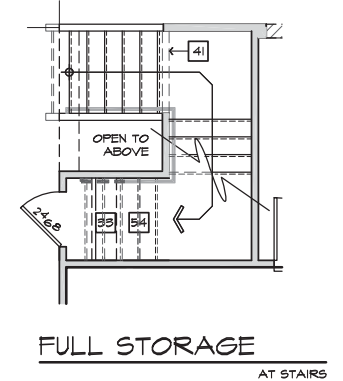

FIRST FLOOR PLAN OPTIONS  
SCALE 1/4"=1'-0" (22'x34") - 1/8"=1'-0" (11'x17')

BASIC PLAN

These designs and drawings are CONFIDENTIAL and the exclusive property of KB Home Corporation and are not to be disclosed without the express permission of KB Home Corporation. Copyright 2014 © KB Home Corporation. All rights reserved.



**NORTH CAROLINA  
40' SERIES**

KB HOME  
NORTH CAROLINA DIVISION  
4506 S. MIAMI BLVD.  
SUITE 180  
DURHAM, NC 27703  
TEL: (919) 768-7980  
FAX: (919) 544-2928

**2018 NORTH  
CAROLINA STATE  
BUILDING  
CODES**

ISSUE DATE: 07/31/18  
PROJECT No.: 1350999:56  
DIVISION MGR.: MCP  
REVISIONS: 07/31/19

- 1 2018 CODE UPDATE NC19055NCP- 01/23/19 MCP
- 2 DIVISION REVISION NC19005NCP- 02/22/19 MCP
- 3 DIVISION REVISION NC19029NCP- 04/22/19 MCP
- 4 DIVISION REVISION NC19055NCP- 07/31/19 FAB

FOR INTERNAL USE ONLY	
REVISED BY:	
1.	
2.	
3.	
4.	
5.	
6.	

PLAN:  
**240.3174-R**  
SHEET:  
**1.5**

**SPEC. LEVEL 1  
RALEIGH-DURHAM  
40' SERIES**

- # FLOOR PLAN NOTES**
1. SINK WITH GARBAGE DISPOSAL - VERIFY DIMENSIONS WITH MANUFACTURER SPEC'S.
  2. DISHWASHER - PROVIDE SURFACE MOUNT AIR GAP VERIFY DIMENSIONS WITH MANUFACTURER SPEC'S.
  3. SLIDE-IN RANGE/ OVEN COMBINATION W/ BUILT-IN LIGHT & FAN (VENT TO OUTSIDE AIR) - VERIFY WITH MANUFACTURER SPEC'S.
  4. 36" COOK-TOP - W/ BUILT-IN HOOD W/LIGHT & FAN, (VENT TO OUTSIDE AIR) - CABINET MOUNTED MICROWAVE INCLUDED OVEN WITH VENT - VERIFY WITH MANUFACTURER SPEC'S.
  5. 34" CLEAR REFRIGERATOR SPACE - PROVIDE PLUMBING FOR ICEMAKER (RECESSED IN WALL).
  6. DOUBLE OVEN - VERIFY WITH MANUFACTURER SPEC'S.
  7. BASE CABINETS - REFER TO INTERIOR ELEVATIONS
  8. UPPER CABINETS - REFER TO INTERIOR ELEVATIONS
  9. PANTRY - SHELVES PER SPEC
  10. ISLAND CABINET - REFER TO INTERIOR ELEVATIONS
  11. TUB/SHOWER COMBINATION WITH 12" FIBERGLASS ENCLOSURE (NON-ABSORBENT) VERIFY DIMENSIONS WITH MFR'S SPEC'S.
  12. OVAL TUB - VERIFY DIMENSIONS WITH MANUFACTURER SPEC'S.
  13. SHOWER PAN WITH MAINSCOT TO 84" - VERIFY DIMENSIONS WITH MANUFACTURER SPEC'S.
  14. SHATTERPROOF (TEMPERED) GLASS SHOWER ENCLOSURE
  15. TOWEL BAR
  16. NOT USED
  17. TOILET PAPER HOLDER
  18. EXTEND VANITY - REFER TO INTERIOR ELEVATIONS
  19. OPTIONAL SINK
  20. PROVIDE WATER AND WASTE FOR WASHER (WASHER CONTROL VALVES) (RECESSED IN WALL)
  21. DRYER VENT
  22. NOT USED
  23. FREE STANDING LAUNDRY SINK - VERIFY DIMENSIONS WITH MFR'S SPEC'S.
  24. ELECTRIC WATER HEATER - LOCATE ON 18" HIGH FRAMED PLATFORM
  25. TEMPERATURE AND PRESSURE RELIEF VALVE DRAIN TO EXTERIOR - MIN. 6" ABOVE & MAX. 24" ABOVE GRADE
  26. NOT USED
  27. NOT USED
  28. PRE-MFR. METAL GAS APPLIANCE FIREPLACE INSTALLED PER MANUFACTURERS INSTRUCTIONS
  29. NON-COMBUSTIBLE HEARTH MATERIAL
  30. ROUTE OF FIREPLACE "B" VENT FROM BELOW - PROVIDE O.S.B. SHAFT
  31. +36" GUARD WALL DETAIL 84/AD5 OR 86/AD5
  32. +34" - +38" HIGH HANDRAIL DETAIL 83/AD5
  33. COATS WITH SHELF & POLE - DETAIL T3/AD4
  34. LINEN - SHELVES PER SPEC
  35. WARDROBE WITH SHELF & POLE - DETAIL T3/AD4 U.N.O.
  36. MEDIA NICHE - REFER TO INTERIOR ELEVATIONS
  37. FLAT SOFFIT - REFER TO PLAN OR ELEVATIONS FOR HEIGHT
  38. NOT USED
  39. LINE OF CEILING BREAK
  40. INTERIOR SHELF - REFER TO PLAN OR INT. ELEV. FOR HGT.
  41. LOW WALL - REFER TO PLAN FOR HEIGHT - DETAIL T2/AD4
  42. LOCATION OF PLUMBING WASTE DROP FROM ABOVE
  43. 2x6 WALL
  44. 2x6 BALLOON FRAMED WALL - REFER TO STRUCTURAL
  45. DOUBLE 2x4 WALL
  46. LINE OF FLOOR ABOVE
  47. LINE OF FLOOR BELOW
  48. EXTERIOR RAIL
  49. F.A.U. VENT TO OUTSIDE AIR
  50. 22"x54" ATTIC ACCESS W/ STAIRS
  51. F.A.U. IN ATTIC - PROVIDE MIN. 22"x30" ATTIC ACCESS PANEL - PROVIDE FUEL GAS. REFER TO UTILITY PLAN DETAIL 88/AD5
  52. DUCT CHASE - DETAIL 89 & 90/AD5 - REFER TO MECH. PLAN
  53. RETURN AIR GRILL (R.A.G.) - REFER TO MECHANICAL PLAN
  54. 1/2" GYPSUM BOARD ON CEILING AND WALLS AT USEABLE SPACE UNDER STAIRS
  55. THE GARAGE SHALL BE SEPARATED FROM THE RESIDENCE AND ITS ATTIC AREA BY NOT LESS THAN 2" GYPSUM BOARD APPLIED TO THE GARAGE SIDE
  56. SEPARATION BETWEEN SECOND FLOOR AND GARAGE CEILING, PROVIDE (1) LAYER OF 2" TYPE "X" GYPSUM BOARD. WALLS SUPPORTING SECOND FLOOR AND GARAGE CEILING, PROVIDE (1) LAYER OF 2" GYPSUM BOARD
  57. EXTERIOR SHELF - REFER TO ELEV. FOR HEIGHT
  58. NOT USED
  59. NOT USED
  60. SECTIONAL GARAGE DOOR - VERIFY WINDOW OPTION
  61. NOT USED
  62. DRAFTSTOP REQUIRED IN FLOOR / CEILING SPACES EXCEEDING 1000 SQUARE FEET. DIVIDED SPACES MUST BE ROUGHLY EQUAL.
  63. OPENINGS BETWEEN GARAGE AND HOUSE SHALL BE EQUIPPED WITH SOLID WOOD DOORS NOT LESS THAN 1 3/8" INCH THICK, OR SHALL BE 20-MINUTE FIRE RATED. DOORS SHALL BE WEATHERSTRIPPED
- NOTE:  
FOR ALL PLAN OPTIONS REFER TO BASIC PLAN FOR INFORMATION NOT SHOWN HERE.

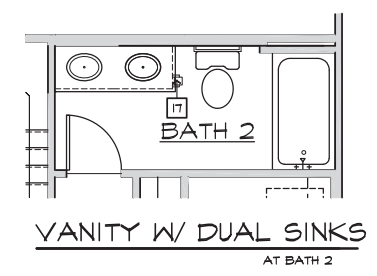
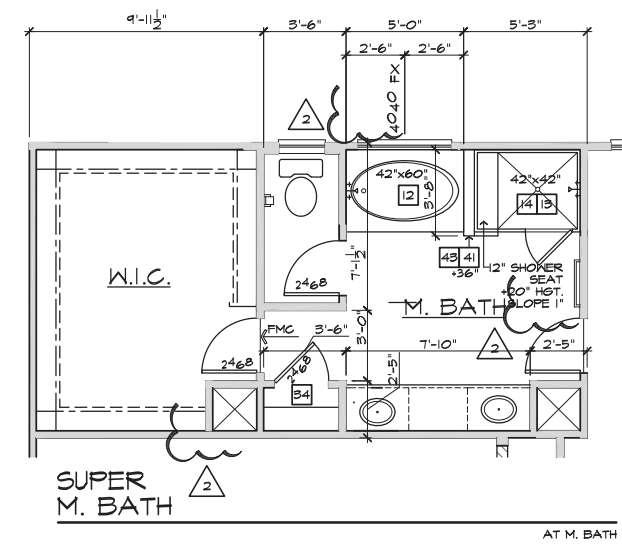
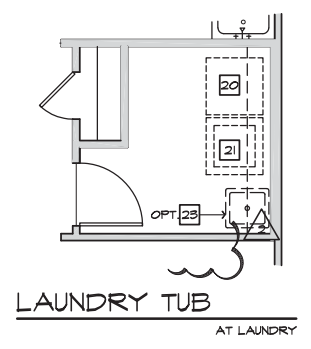

**SECOND FLOOR PLAN OPTIONS**  
SCALE 1/4"=1'-0" (22"x34") - 1/8"=1'-0" (11"x17")

BASIC PLAN

These designs and drawings are CONFIDENTIAL and the exclusive property of KB Home Corporation and are not to be disclosed without the express permission of KB Home Corporation. Copyright 2014 © KB Home Corporation. All rights reserved.



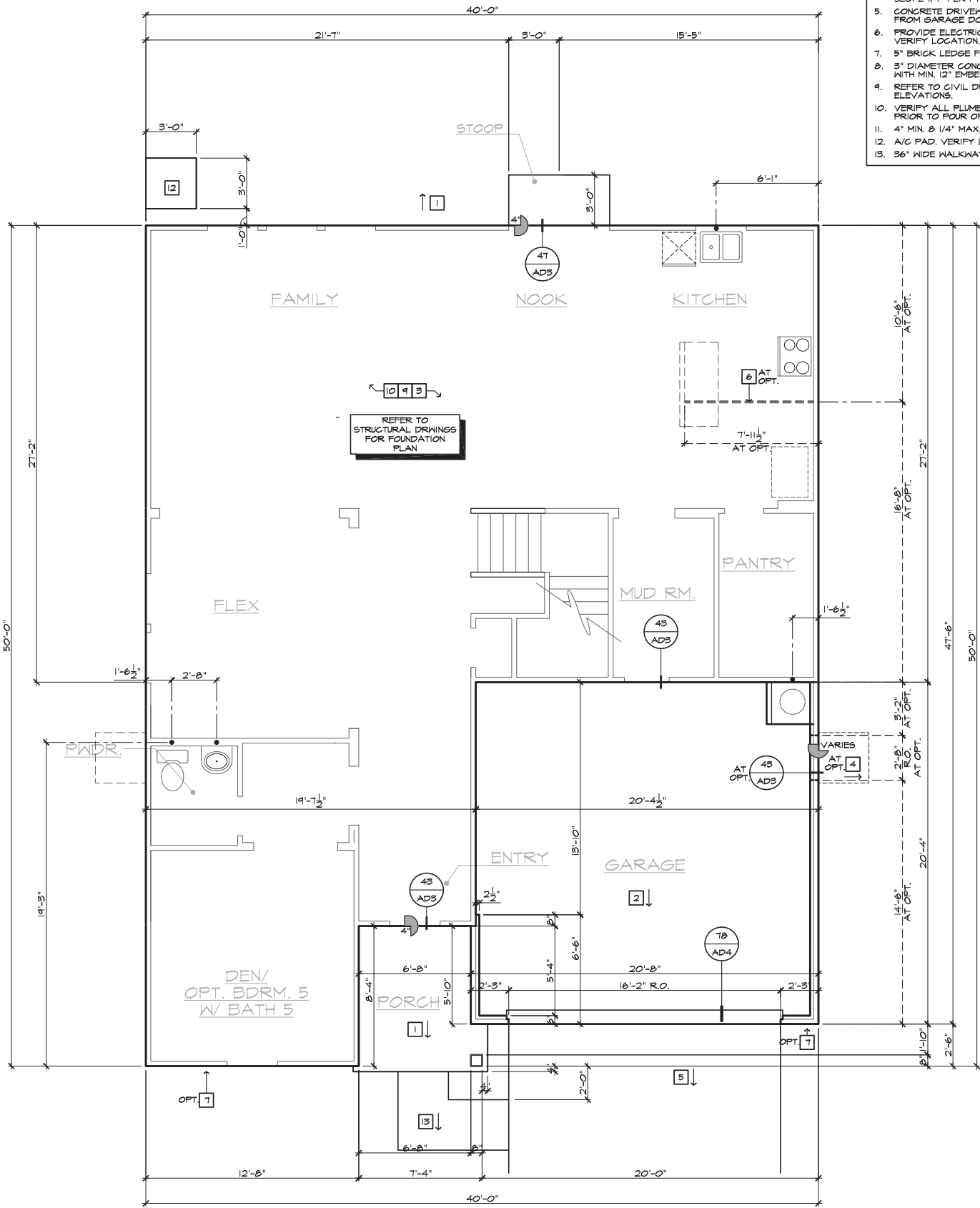

- # SLAB PLAN NOTES**
- NOTE: NOT ALL KEY NOTES APPLY.
1. CONCRETE PATIO/PORCH SLAB PER STRUCTURAL- SLOPE 1/4" PER FT. MIN.
  2. CONCRETE GARAGE SLAB PER STRUCTURAL- SLOPE 1/8" PER 1'-0" MIN. TOWARD DOOR OPENING.
  3. CONCRETE FOUNDATION PER STRUCTURAL.
  4. CONCRETE STOOP, 36"x36" STANDARD SLOPE 1/4" PER FT. MIN.
  5. CONCRETE DRIVEWAY SLOPE 1/4" PER FT. MIN. AWAY FROM GARAGE DOOR OPENING.
  6. PROVIDE ELECTRICAL CONDUIT UNDER SLAB AT ISLAND. VERIFY LOCATION.
  7. 5" BRICK LEDGE FOR MASONRY VENEER.
  8. 3" DIAMETER CONCRETE FILLED PIPE BOLLARD 36" HIGH WITH MIN. 12" EMBEDMENT INTO CONCRETE.
  9. REFER TO CIVIL DRAWINGS FOR ALL FINISH SURFACE ELEVATIONS.
  10. VERIFY ALL PLUMBING STUB DIMENSIONS SHOWN HERE PRIOR TO POUR OF SLAB.
  11. 4" MIN. Ø 1/4" MAX. TO HARD SURFACE.
  12. A/C PAD. VERIFY LOCATION.
  13. 36" WIDE WALKWAY- SLOPE 1/4" PER FT. MIN.



**NORTH CAROLINA  
40' SERIES**

KB HOME  
NORTH CAROLINA DIVISION  
4506 S. MIAMI BLVD.  
SUITE 180  
DURHAM, NC 27703  
TEL: (919) 768-7980  
FAX: (919) 544-2928

**2018 NORTH  
CAROLINA STATE  
BUILDING  
CODES**

ISSUE DATE: 07/31/18  
PROJECT No.: 1350999:56  
DIVISION MGR.: MCP  
REVISIONS: 07/31/19

- 1 2018 CODE UPDATE NCI9055NCP- 01/23/19 MCP
- 2 DIVISION REVISION NCI9005NCP- 02/22/19 MCP
- 3 DIVISION REVISION NCI9029NCP- 04/22/19 MCP
- 4 DIVISION REVISION NCI9055NCP- 07/31/19 FAB

FOR INTERNAL USE ONLY

REVISIONED BY:	DATE:
1	
2	
3	
4	
5	
6	

PLAN:  
**240.3174-R**  
SHEET:  
**2.1**

**SPEC. LEVEL 1  
RALEIGH-DURHAM  
40' SERIES**

**SLAB INTERFACE PLAN 'A'**  
SCALE 1/4"=1'-0" (22"X34") - 1/8"=1'-0" (11"X17")

BASIC PLAN AT SLAB-ON-GRADE

These designs and drawings are CONFIDENTIAL and the exclusive property of KB Home Corporation and are not to be disclosed without the express permission of KB Home Corporation. Copyright 2014 © KB Home Corporation. All rights reserved.



- # SLAB PLAN NOTES**
- NOTE: NOT ALL KEY NOTES APPLY.
1. CONCRETE PATIO/PORCH SLAB PER STRUCTURAL- SLOPE 1/4" PER FT. MIN.
  2. CONCRETE GARAGE SLAB PER STRUCTURAL- SLOPE 1/8" PER 1'-0" MIN. TOWARD DOOR OPENING.
  3. CONCRETE FOUNDATION PER STRUCTURAL.
  4. CONCRETE STOOP; 36"x36" STANDARD SLOPE 1/4" PER FT. MIN.
  5. CONCRETE DRIVEWAY SLOPE 1/4" PER FT. MIN. AWAY FROM GARAGE DOOR OPENING.
  6. PROVIDE ELECTRICAL CONDUIT UNDER SLAB AT ISLAND. VERIFY LOCATION.
  7. 5" BRICK LEDGE FOR MASONRY VENEER.
  8. 3" DIAMETER CONCRETE FILLED PIPE BOLLARD 36" HIGH WITH MIN. 12" EMBEDMENT INTO CONCRETE.
  9. REFER TO CIVIL DRAWINGS FOR ALL FINISH SURFACE ELEVATIONS.
  10. VERIFY ALL PLUMBING STUB DIMENSIONS SHOWN HERE PRIOR TO POUR OF SLAB.
  11. 4" MIN. Ø 1/4" MAX. TO HARD SURFACE.
  12. A/C PAD. VERIFY LOCATION.
  13. 36" WIDE WALKWAY- SLOPE 1/4" PER FT. MIN.

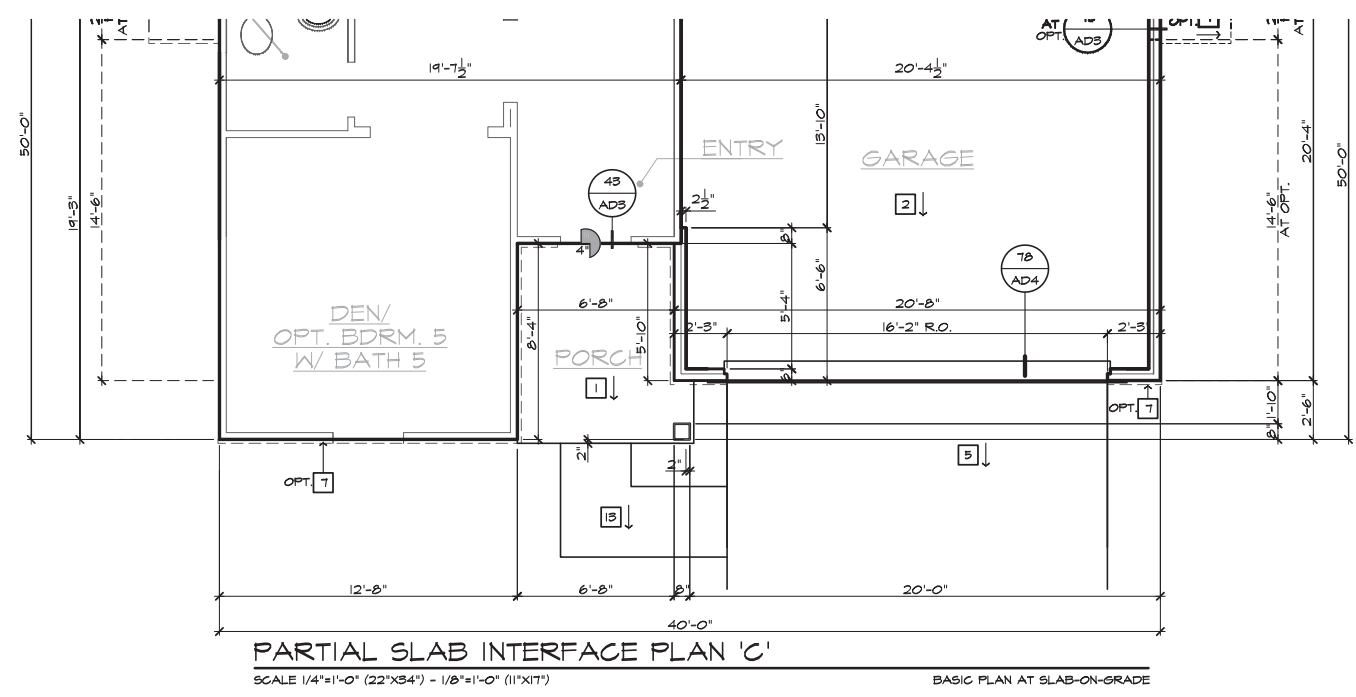

**NORTH CAROLINA  
40' SERIES**

KB HOME  
 NORTH CAROLINA DIVISION  
 4506 S. MIAMI BLVD.  
 SUITE 180  
 DURHAM, NC 27703  
 TEL: (919) 768-7980  
 FAX: (919) 544-2928

**2018 NORTH  
CAROLINA STATE  
BUILDING  
CODES**

ISSUE DATE: 07/31/18  
 PROJECT No.: 1350999:56  
 DIVISION MGR.: MCP  
 REVISIONS: 07/31/19

- 1 2018 CODE UPDATE  
NC1905NCP- 01/23/19 MCP
- 2 DIVISION REVISION  
NC1905NCP- 02/22/19 MCP
- 3 DIVISION REVISION  
NC1902NCP- 04/22/19 MCP
- 4 DIVISION REVISION  
NC1905NCP- 07/31/19 FAB

FOR INTERNAL USE ONLY

REVISION BY:	DATE:	DESCRIPTION:
1.		
2.		
3.		
4.		
5.		
6.		

PLAN:  
**240.3174-R**  
 SHEET:  
**2.2**

**SPEC. LEVEL 1  
RALEIGH-DURHAM  
40' SERIES**

These designs and drawings are CONFIDENTIAL and the exclusive property of KB Home Corporation and are not to be disclosed without the express permission of KB Home Corporation. Copyright 2014 © KB Home Corporation. All rights reserved.

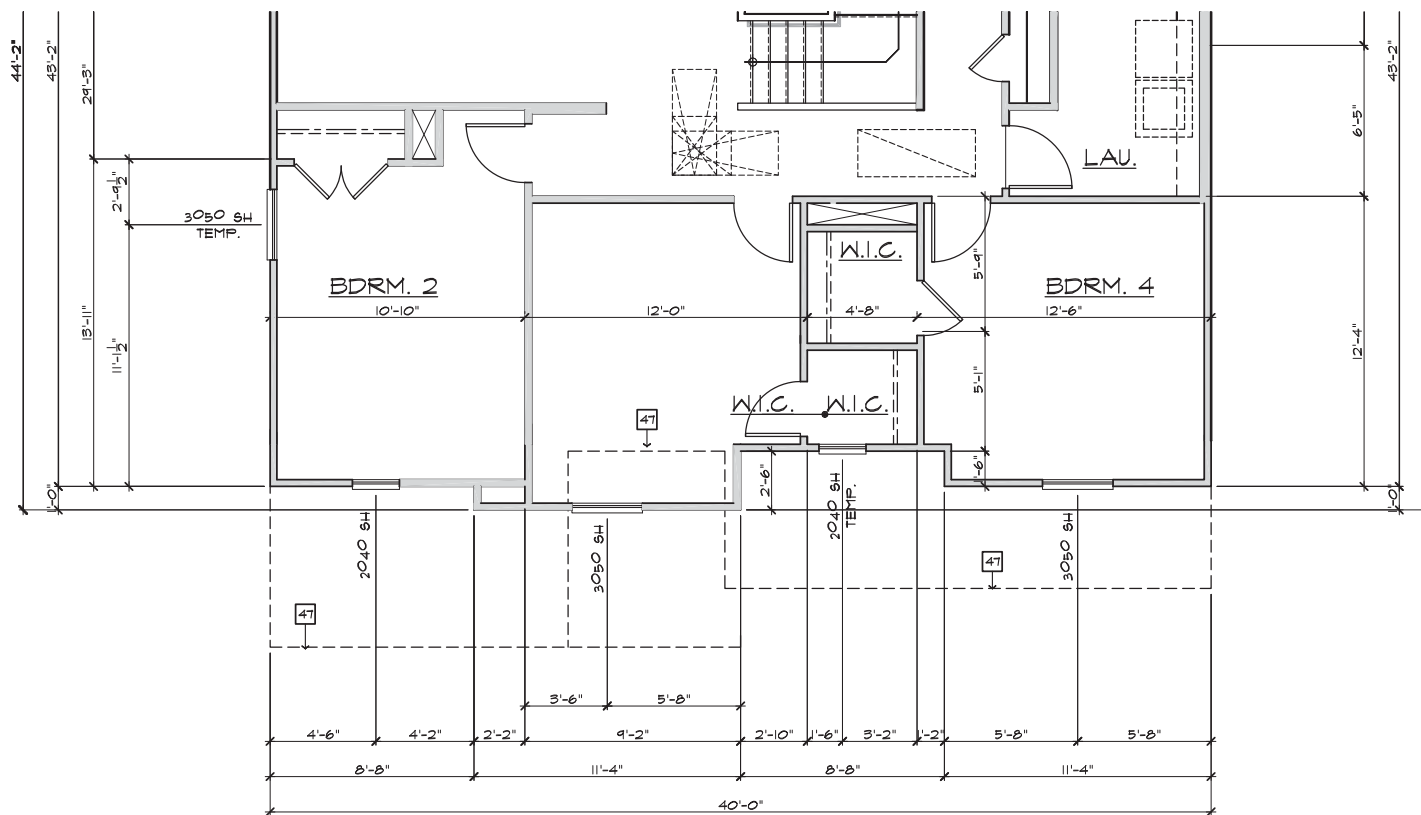

PARTIAL SECOND FLOOR PLAN 'C'

SCALE 1/4"=1'-0" (22'X34") - 1/8"=1'-0" (11'X17")

BASIC PLAN

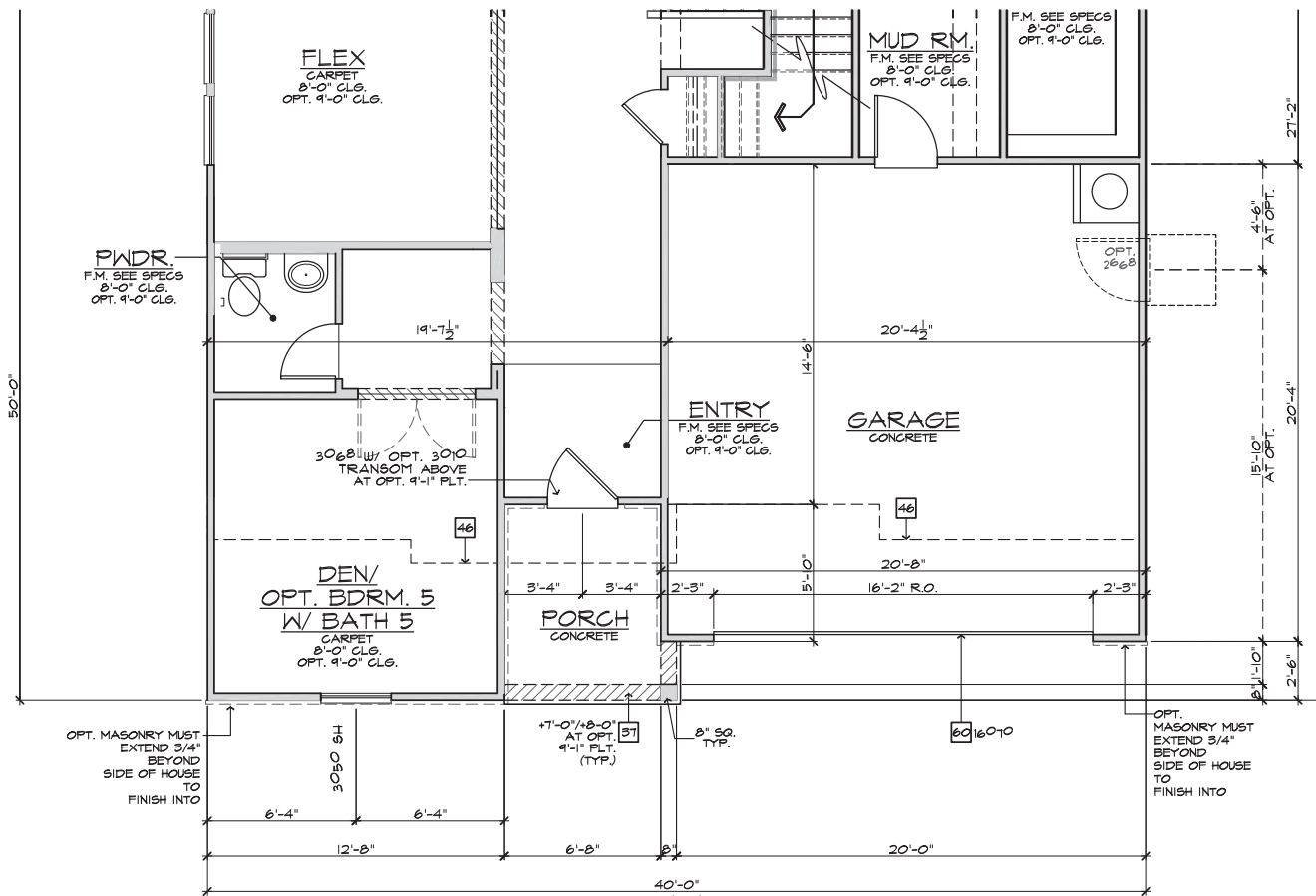

PARTIAL FIRST FLOOR PLAN 'C'

SCALE 1/4"=1'-0" (22'X34") - 1/8"=1'-0" (11'X17")

BASIC PLAN

#	PARTIAL PLAN NOTES
NOTE: NOT ALL KEY NOTES APPLY.	
31.	+36" GUARD WALL DETAIL 84/AD5 OR 86/AD5
37.	FLAT SOFFIT - REFER TO PLAN OR ELEVATIONS FOR HEIGHT
38.	NOT USED
39.	LINE OF CEILING BREAK
40.	INTERIOR SHELF - REFER TO PLAN OR INT. ELEV. FOR HGT.
41.	LOW WALL - REFER TO PLAN FOR HEIGHT - DETAIL 72/AD4
43.	2x6 WALL
44.	2x6 BALLOON FRAMED WALL - REFER TO STRUCTURAL
45.	DOUBLE 2x4 WALL
46.	LINE OF FLOOR ABOVE
47.	LINE OF FLOOR BELOW
48.	EXTERIOR RAIL
55.	THE GARAGE SHALL BE SEPARATED FROM THE RESIDENCE AND ITS ATTIC AREA BY NOT LESS THAN 7" GYPSUM BOARD APPLIED TO THE GARAGE SIDE
56.	SEPARATION BETWEEN SECOND FLOOR AND GARAGE CEILING, PROVIDE (1) LAYER OF 7" TYPE 'X' GYPSUM BOARD, WALLS SUPPORTING SECOND FLOOR AND GARAGE CEILING; PROVIDE (1) LAYER OF 7" GYPSUM BOARD
57.	EXTERIOR SHELF - REFER TO ELEV. FOR HEIGHT
60.	SECTIONAL GARAGE DOOR - VERIFY WINDOW OPTION



**NORTH CAROLINA  
40' SERIES**

KB HOME  
NORTH CAROLINA DIVISION  
4506 S. MIAMI BLVD.  
SUITE 180  
DURHAM, NC 27703  
TEL: (919) 768-7980  
FAX: (919) 544-2928

**2018 NORTH  
CAROLINA STATE  
BUILDING  
CODES**

ISSUE DATE: 07/31/18  
PROJECT No.: 1350999:56  
DIVISION MGR.: MCP  
REVISIONS: 07/31/19

- 1 2018 CODE UPDATE  
NC1905NCF- 01/23/19 MCP
- 2 DIVISION REVISION  
NC1905NCF- 02/28/19 MCP
- 3 DIVISION REVISION  
NC1902NCF- 04/22/19 MCP
- 4 DIVISION REVISION  
NC1905NCF- 07/31/19 FAB

FOR INTERNAL USE ONLY	
REVISED BY:	
1.	
2.	
3.	
4.	
5.	
6.	

PLAN:  
**240.3174-R**  
SHEET:  
**3.C1**

**SPEC. LEVEL 1  
RALEIGH-DURHAM  
40' SERIES**

NOTE:  
REFER TO BASIC FLOOR PLAN FOR INFORMATION NOT SHOWN HERE

These designs and drawings are CONFIDENTIAL and the exclusive property of KB Home Corporation and are not to be disclosed without the express permission of KB Home Corporation. Copyright 2014 © KB Home Corporation, all rights reserved.

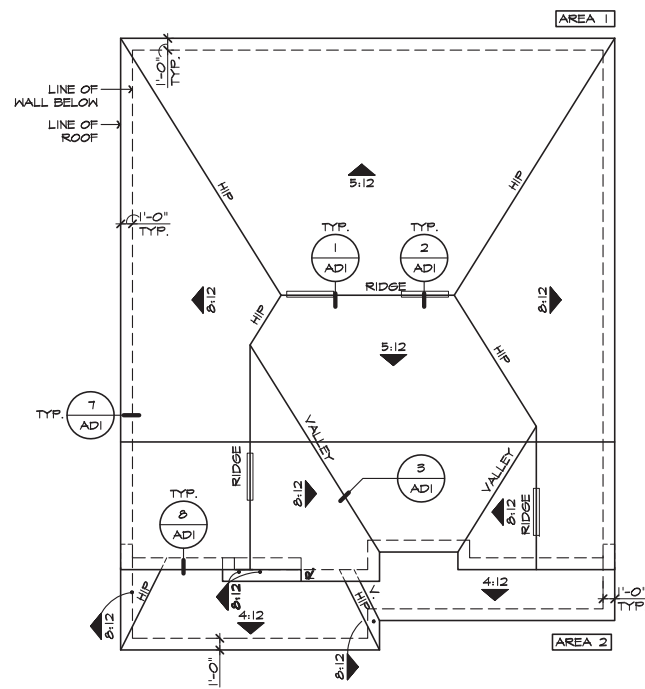

**ROOF PLAN 'C'**

SCALE 1/8"=1'-0" (22'X34') - 1/16"=1'-0" (11'X17')



**REAR ELEVATION 'C'**

SCALE 1/4"=1'-0" (22'X34') - 1/8"=1'-0" (11'X17')

**ELEVATION NOTES**

- NOTE: NOT ALL KEY NOTES APPLY.**
1. ROOF MATERIAL - REFER TO ROOF NOTES
  2. 2X FASCIA/BARGE BOARD WITH FASCIA CAP
  3. G.I. FLASHING
  4. G.I. FLASHING & SADDLE/CRICKET
  5. G.I. DRIP SCREED
  6. 24"x24" CHIMNEY
  7. DECORATIVE VENT
  8. DECORATIVE CORBEL
  9. DECORATIVE SHUTTERS
  10. FENESTRATION, SEE ELEVATION FOR TYPE
  11. RECESSED ELEMENT
  12. DECORATIVE TRIM FYPON OR EQ. SEE ELEVATION FOR TYPE
  13. TRIM - SEE ELEVATION FOR SIZE
  14. SYNTHETIC MATERIAL
  15. PRE-MANUFACTURED DECORATIVE COLUMN (SIZE, SEE ELEV.) FYPON OR EQ. SURROUNDING STRUCTURAL FOOT.
  16. SITE-BUILT COLUMN - SEE ELEVATION FOR TYPE
  17. SHAKE SIDING
  18. STONE VENEER PER SPECS
  19. BRICK/MASONRY VENEER PER SPECS
  20. BUILT UP BRICK COLUMN
  21. SOLDIER COURSE
  22. ROWLOCK COURSE
  23. FRIEZE BOARD
  24. SIDING W/ 4" CORNER TRIM PER SPECS
  25. P.T. POST W/ WRAP - SEE STRUCTURAL FOR SIZE
  26. PRE-FAB DECORATIVE TRIM
  27. LIGHT WEIGHT PRECAST STONE TRIM
  28. RAILINGS (436" U.N.O.)
  29. VINYL WRAP
  30. DECORATIVE WINDOW/DOOR TRIM - FYPON OR EQ. SEE ELEVATION FOR SIZE.
  31. BRACKET OR KICKER - FYPON OR EQ.
  32. ENTRY DOOR
  33. CONCRETE STOOP/ PORCH - SEE SLAB INTERFACE PLAN.
  34. SECTIONAL GARAGE DOOR PER SPECS
  35. ALUMINUM WRAP
  36. OPTIONAL DOOR/WINDOW - REFER TO PLAN OPTIONS
  37. OPTIONAL STANDING SEAM METAL ROOF
  38. KEYSTONE
  39. SOLDIER CROWN
  40. JACK SOLDIER COURSE
  41. WATER TABLE
  42. ATRIUM DOOR
  43. PILASTER - SEE ELEVATION FOR TYPE

**ROOF PLAN NOTES 'C'**

**5:12** INDICATES ROOF SLOPE AND DIRECTION, U.N.O.

ROOF MATERIAL: COMPOSITION SHINGLE  
 12" (INCHES) TYPICAL ROOF OVERHANG AT RAKE, U.N.O.  
 12" (INCHES) TYPICAL ROOF OVERHANG AT EAVE, U.N.O.  
 LOCATE EAVE/ RAFTER VENTS EQUALLY BALANCED AROUND HOUSE EXCEPT ABOVE SHEARWALL PANELS.

**ATTIC VENT CALCULATIONS**

PROVIDE 1 SQ. IN. OF VENTILATION PER 500 SQ. IN. OF ATTIC SPACE. PROVIDE THAT AT LEAST 50% & NO MORE THAN 50% OF THE REQ. VENTILATING AREA IS PROVIDED BY VENTILATORS LOCATED IN THE UPPER PORTION OF THE ATTIC, (HIGH VENTING) AT 3'-0" ABOVE EAVE VENT WITH THE BALANCE BEING PROVIDED BY EAVE VENTS, (LOW VENTING)  
 \* CALCULATION BY 1/50, HIGH/LOW VENTING NOT REQUIRED.

**AREA 1 / MAIN**

VENTILATION REQUIRED:	1725 SQ. FT. / 500 =	3.45 SQ. FT.
ATTIC AREA	X 144 =	497 SQ. IN.
	X 50% =	248 SQ. IN.

**VENTILATION PROVIDED:**

LIN. FEET OF RIDGE VENT AT (10 SQ. IN./FOOT) =	432 SQ. IN.
LIN. FEET OF VENTILATED SOFFIT (5 SQ. IN./FOOT) =	605 SQ. IN.
<b>TOTAL VENTILATION PROVIDED:</b>	<b>1037 SQ. IN.</b>

**AREA 2 / PORCH**

VENTILATION REQUIRED:	* 225 SQ. FT. / 50 =	4.5 SQ. FT.
ATTIC AREA	X 144 =	648 SQ. IN.

**VENTILATION PROVIDED:**

LIN. FEET OF RIDGE VENT AT (10 SQ. IN./FOOT) =	90 SQ. IN.
LIN. FEET OF VENTILATED SOFFIT (5 SQ. IN./FOOT) =	140 SQ. IN.
<b>TOTAL VENTILATION PROVIDED:</b>	<b>230 SQ. IN.</b>

**NOTES:**  
 ALL VENT OPENINGS SHALL BE COVERED WITH 1/4" CORROSION RESISTANT METAL MESH.  
 FRAMER SHALL BE RESPONSIBLE FOR COORDINATING WITH TRUSS MANUFACTURER TO ACCOMMODATE ALL ATTIC VENTS.  
 ALL VENTS SHALL BE INSTALLED SO AS TO MAKE THEM WATER-PROOF & WALL MOUNTED LOUVERS SHALL BE SEALED & FLASHED W/ MOISTOP IN THE SAME MANNER PRESCRIBED FOR WINDOW INSTALLATION.  
 PROVIDE APPROVED INSULATION DAMS (BAFFLES) WHERE VENT BLOCKS ARE USED BETWEEN ROOF FRAMING MEMBERS TO PREVENT VENT HOLES FROM BEING BLOCKED BY INSULATION. LOCATE HIGH VENTING MINIMUM 3'-0" VERTICAL DISTANCE ABOVE EAVES.  
 WHEN GABLE END TRUSS MEMBERS BLOCK GABLE END VENTS, PROVIDE ADEQUATE ADDITIONAL VENTILATION BY MEANS OF ROOF TILE VENTS.



**NORTH CAROLINA 40' SERIES**

KB HOME  
 NORTH CAROLINA DIVISION  
 4506 S. MIAMI BLVD.  
 SUITE 180  
 DURHAM, NC 27703  
 TEL: (919) 768-7980  
 FAX: (919) 544-2928

**2018 NORTH CAROLINA STATE BUILDING CODES**

ISSUE DATE: 07/31/18  
 PROJECT No.: 1350999:56  
 DIVISION MGR.: MCP  
 REVISIONS: 07/31/19

- 1. 2018 CODE UPDATE NC1905NCF- 01/23/19 MCP
- 2. DIVISION REVISION NC1905NCF- 02/28/19 MCP
- 3. DIVISION REVISION NC1903NCF- 04/22/19 MCP
- 4. DIVISION REVISION NC1905NCF- 07/31/19 FAB

FOR INTERNAL USE ONLY

REVISION BY:	
1.	
2.	
3.	
4.	
5.	
6.	

PLAN:  
**240.3174-R**  
 SHEET:  
**3.C2**

**SPEC. LEVEL 1 RALEIGH-DURHAM 40' SERIES**

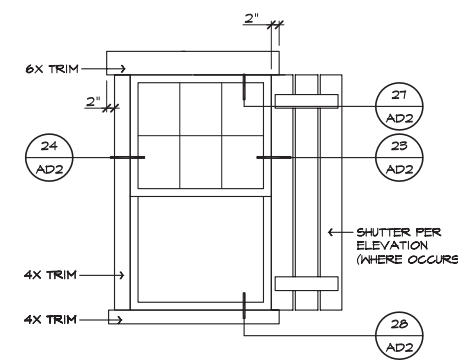

**DETAIL 'A'**

N.T.S.

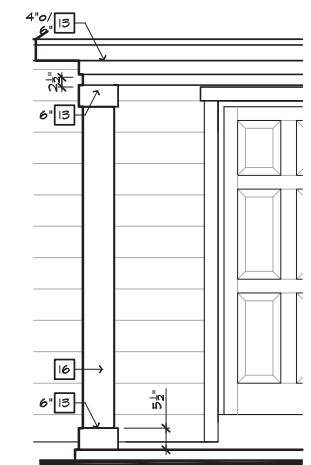

**DETAIL 'B'**

N.T.S.

These designs and drawings are CONFIDENTIAL and the exclusive property of KB Home Corporation and are not to be disclosed without the express permission of KB Home Corporation. Copyright 2014 © KB Home Corporation. All rights reserved.

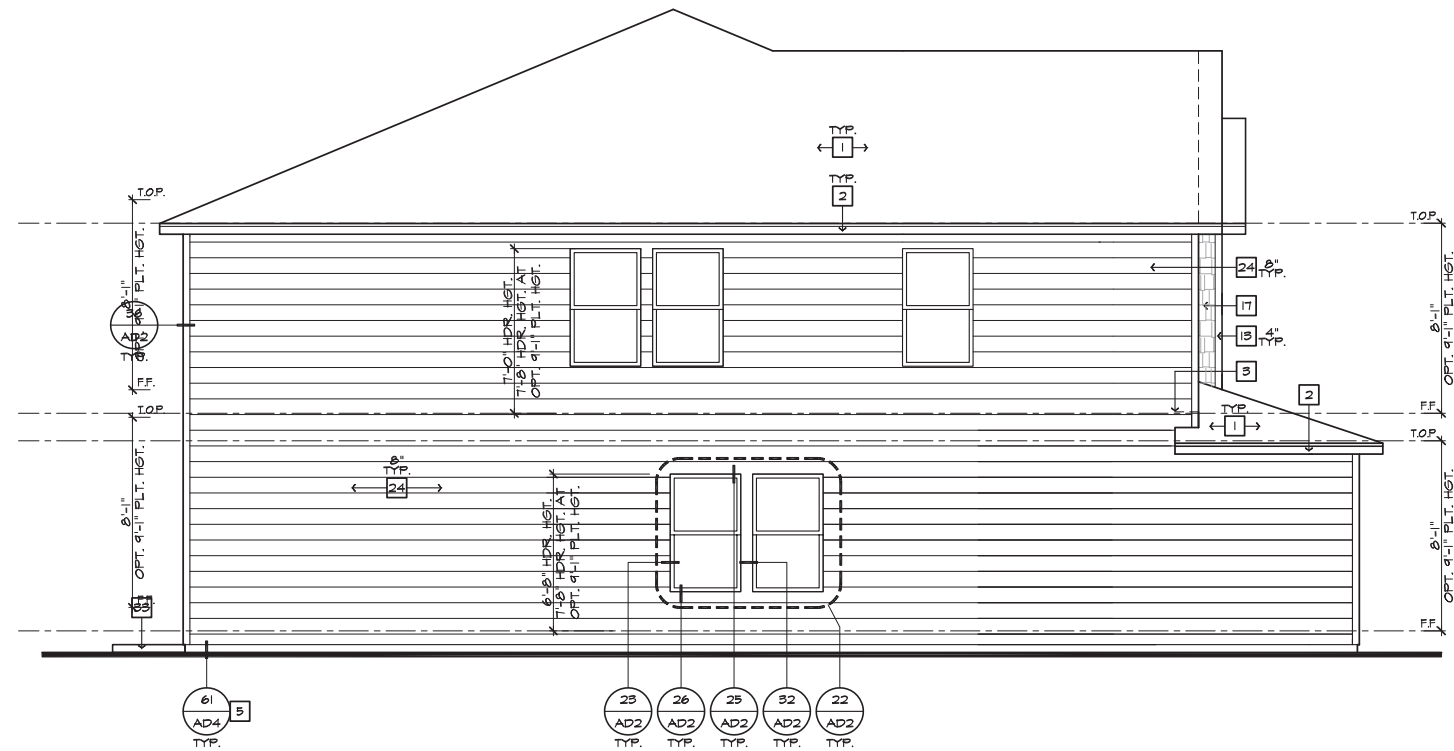

**LEFT ELEVATION 'C'**  
SCALE 1/4"=1'-0" (22"X34") - 1/8"=1'-0" (11"X17")

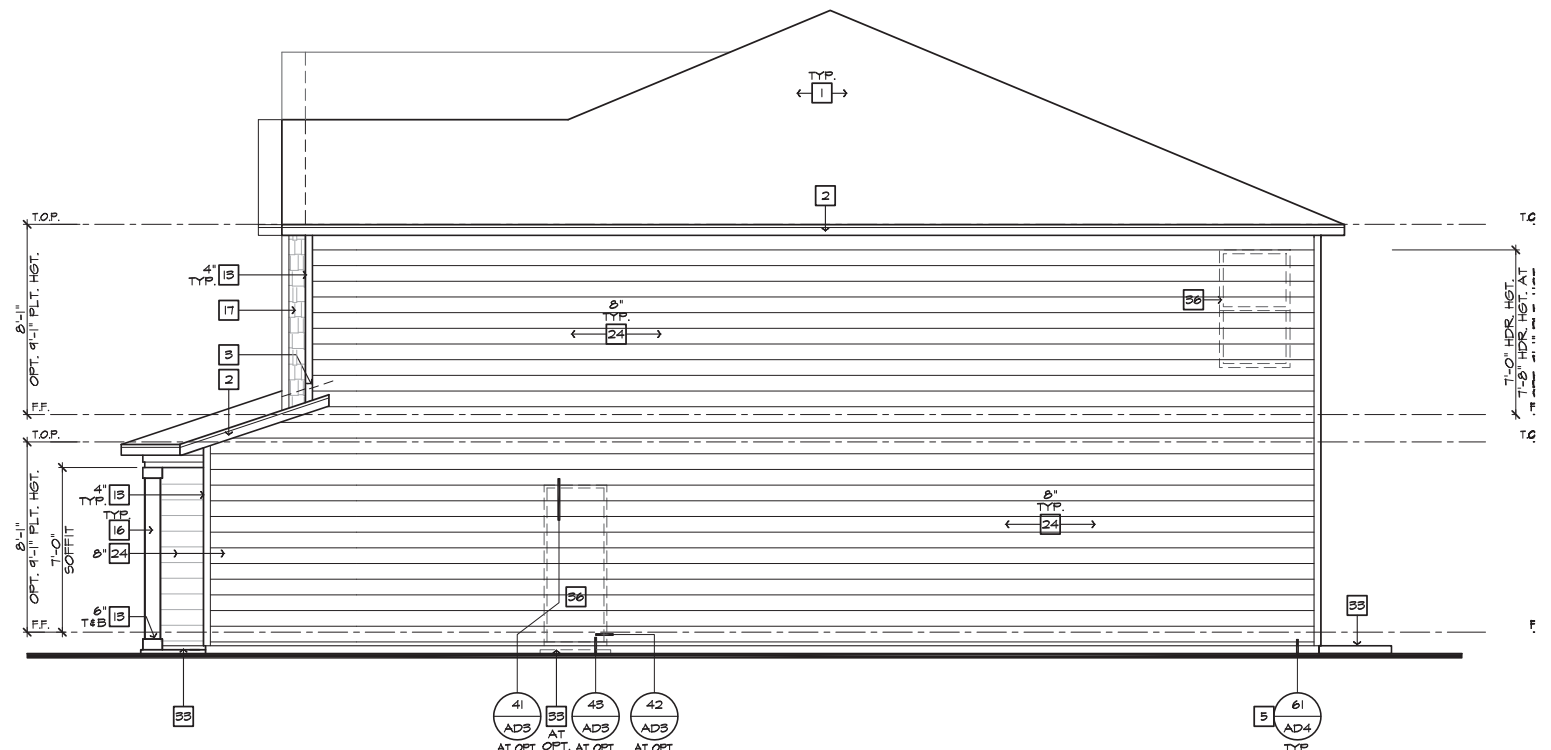

**RIGHT ELEVATION 'C'**  
SCALE 1/4"=1'-0" (22"X34") - 1/8"=1'-0" (11"X17")

#	ELEVATION NOTES
<b>NOTE: NOT ALL KEY NOTES APPLY.</b>	
1.	ROOF MATERIAL - REFER TO ROOF NOTES
2.	2X FASCIA/BARGE BOARD WITH FASCIA CAP
3.	G.I. FLASHING
4.	G.I. FLASHING & SADDLE/CRIKETT
5.	G.I. DRIP SCREED
6.	24"X24" CHIMNEY
7.	DECORATIVE VENT
8.	DECORATIVE CORBEL
9.	DECORATIVE SHUTTERS
10.	PEDIMENT, SEE ELEVATION FOR TYPE
11.	RECESSED ELEMENT
12.	DECORATIVE TRIM FYPON OR EQ. SEE ELEVATION FOR TYPE
13.	TRIM - SEE ELEVATION FOR SIZE
14.	SYNTHETIC MATERIAL
15.	PRE-MANUFACTURED DECORATIVE COLUMN (SIZE, SEE ELEV.) FYPON OR EQ. SURROUNDING STRUCTURAL POST.
16.	SITE-BUILT COLUMN - SEE ELEVATION FOR TYPE
17.	SHAKE SIDING
18.	STONE VENEER PER SPECS
19.	BRICK/MASONRY VENEER PER SPECS
20.	BUILT UP BRICK COLUMN
21.	SOLDIER COURSE
22.	ROWLOCK COURSE
23.	FRIEZE BOARD
24.	SIDING W/ 4" CORNER TRIM PER SPECS
25.	P.T. POST W/ WRAP - SEE STRUCTURAL FOR SIZE
26.	PRE-FAB DECORATIVE TRIM
27.	LIGHT WEIGHT PRECAST STONE TRIM
28.	RAILINGS (436" U.N.O.)
29.	VINYL WRAP
30.	DECORATIVE WINDOW/DOOR TRIM - FYPON OR EQ. SEE ELEVATION FOR SIZE.
31.	BRACKET OR KICKER - FYPON OR EQ.
32.	ENTRY DOOR
33.	CONCRETE STOOP/ PORCH - SEE SLAB INTERFACE PLAN.
34.	SECTIONAL GARAGE DOOR PER SPECS
35.	ALUMINUM WRAP
36.	OPTIONAL DOOR/WINDOW - REFER TO PLAN OPTIONS
37.	OPTIONAL STANDING SEAM METAL ROOF
38.	KEYSTONE
39.	SOLDIER CROWN
40.	JACK SOLDIER COURSE
41.	WATER TABLE
42.	ATRIUM DOOR
43.	PILASTER - SEE ELEVATION FOR TYPE



**NORTH CAROLINA  
40' SERIES**

KB HOME  
NORTH CAROLINA DIVISION  
4506 S. MIAMI BLVD.  
SUITE 180  
DURHAM, NC 27703  
TEL: (919) 768-7980  
FAX: (919) 544-2928

**2018 NORTH  
CAROLINA STATE  
BUILDING  
CODES**

ISSUE DATE: 07/31/18  
PROJECT No.: 1350999:56  
DIVISION MGR.: MCP  
REVISIONS: 07/31/19

- 1. 2018 CODE UPDATE  
NC1905NCF- 01/23/19 MCP
- 2. DIVISION REVISION  
NC1905NCF- 02/28/19 MCP
- 3. DIVISION REVISION  
NC1902NCF- 04/22/19 MCP
- 4. DIVISION REVISION  
NC1905NCF- 07/31/19 FAB

FOR INTERNAL USE ONLY	
REVISION NO.	REVISION BY:
1.	
2.	
3.	
4.	
5.	
6.	

PLAN:  
**240.3174-R**  
SHEET:  
**3.C3**

**SPEC. LEVEL 1  
RALEIGH-DURHAM  
40' SERIES**

These designs and drawings are CONFIDENTIAL and the exclusive property of KB Home Corporation and are not to be disclosed without the express permission of KB Home Corporation. Copyright 2014 © KB Home Corporation. All rights reserved.



**NORTH CAROLINA  
40' SERIES**

KB HOME  
NORTH CAROLINA DIVISION  
4506 S. MIAMI BLVD.  
SUITE 180  
DURHAM, NC 27703  
TEL: (919) 768-7980  
FAX: (919) 544-2928

**2018 NORTH  
CAROLINA STATE  
BUILDING  
CODES**

ISSUE DATE: 07/31/18  
PROJECT No.: 1350999:56  
DIVISION MGR.: MCP  
REVISIONS: 07/31/19

- 1 2018 CODE UPDATE  
NC1905NCF- 01/23/19 MCP
- 2 DIVISION REVISION  
NC1905NCF- 02/28/19 MCP
- 3 DIVISION REVISION  
NC19023NCF- 04/22/19 MCP
- 4 DIVISION REVISION  
NC19055NCF- 07/31/19 FAB

FOR INTERNAL USE ONLY	
REVISION NO.	REVISION BY
1	
2	
3	
4	
5	
6	

PLAN:  
**240.3174-R**  
SHEET:  
**3.C5**

**SPEC. LEVEL 1  
RALEIGH-DURHAM  
40' SERIES**

#	ELEVATION NOTES
<b>NOTE: NOT ALL KEY NOTES APPLY.</b>	
1.	ROOF MATERIAL - REFER TO ROOF NOTES
2.	2X FASCIA/BARGE BOARD WITH FASCIA CAP
3.	G.I. FLASHING
4.	G.I. FLASHING & SADDLE/CRICKET
5.	G.I. DRIP SCREED
6.	24"x24" CHIMNEY
7.	DECORATIVE VENT
8.	DECORATIVE CORBEL
9.	DECORATIVE SHUTTERS
10.	PEDIMENT, SEE ELEVATION FOR TYPE
11.	RECESSED ELEMENT
12.	DECORATIVE TRIM FYPON OR EQ. SEE ELEVATION FOR TYPE
13.	TRIM - SEE ELEVATION FOR SIZE
14.	SYNTHETIC MATERIAL
15.	PRE-MANUFACTURED DECORATIVE COLUMN (SIZE, SEE ELEV.) FYPON OR EQ. SURROUNDING STRUCTURAL POST.
16.	SITE-BUILT COLUMN - SEE ELEVATION FOR TYPE
17.	SHAKE SIDING
18.	STONE VENEER PER SPECS
19.	BRICK/MASONRY VENEER PER SPECS
20.	BUILT UP BRICK COLUMN
21.	SOLDIER COURSE
22.	ROWLOCK COURSE
23.	FRIEZE BOARD
24.	SIDING W/ 4" CORNER TRIM PER SPECS
25.	P.T. POST W/ WRAP - SEE STRUCTURAL FOR SIZE
26.	PRE-FAB DECORATIVE TRIM
27.	LIGHT WEIGHT PRECAST STONE TRIM
28.	RAILINGS (436" U.N.O.)
29.	VINYL WRAP
30.	DECORATIVE WINDOW/DOOR TRIM - FYPON OR EQ. SEE ELEVATION FOR SIZE.
31.	BRACKET OR KICKER - FYPON OR EQ.
32.	ENTRY DOOR
33.	CONCRETE STOOP/ PORCH - SEE SLAB INTERFACE PLAN.
34.	SECTIONAL GARAGE DOOR PER SPECS
35.	ALUMINUM WRAP
36.	OPTIONAL DOOR/WINDOW - REFER TO PLAN OPTIONS
37.	OPTIONAL STANDING SEAM METAL ROOF
38.	KEYSTONE
39.	SOLDIER CROWN
40.	JACK SOLDIER COURSE
41.	WATER TABLE
42.	ATRIUM DOOR
43.	PILASTER - SEE ELEVATION FOR TYPE
<b>9'-1" PLATE OPTION</b>	
<b>NOTE:</b> WINDOW SIZES WILL INCREASE BY 1' AT 9'-1" PLATE OPTIONS. HEADER HEIGHTS FOR ALL WINDOWS WILL BE T-8" AT 9'-1" PLATE OPTIONS.	

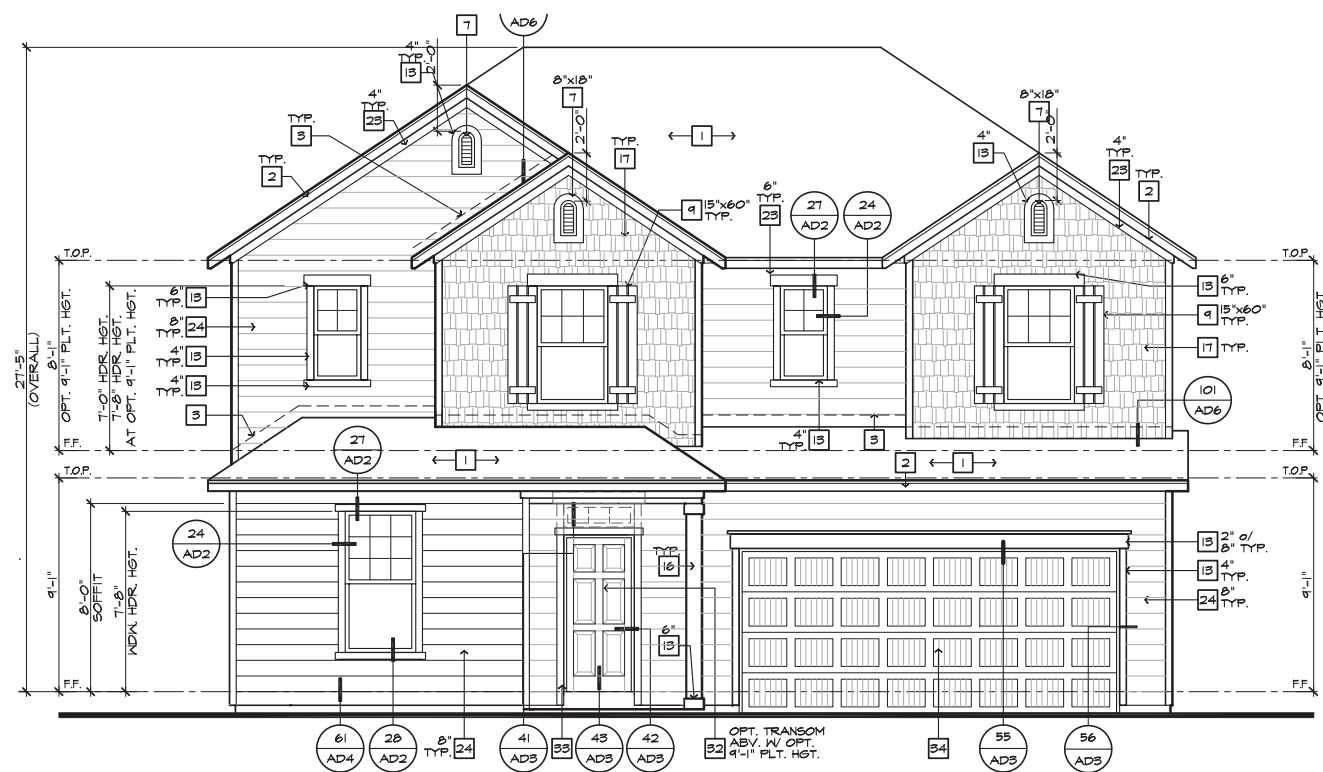

**FRONT ELEVATION 'C'**  
**AT OPTIONAL 9'-1" PLT. HGT.**  
SCALE 1/4"=1'-0" (22"x34") - 1/8"=1'-0" (11"x17")

These designs and drawings are CONFIDENTIAL and the exclusive property of KB Home Corporation and are not to be disclosed without the express permission of KB Home Corporation. Copyright 2014 © KB Home Corporation. All rights reserved.



**NORTH CAROLINA  
40' SERIES**

KB HOME  
NORTH CAROLINA DIVISION  
4506 S. MIAMI BLVD.  
SUITE 180  
DURHAM, NC 27703  
TEL: (919) 768-7980  
FAX: (919) 544-2928

**2018 NORTH  
CAROLINA STATE  
BUILDING  
CODES**

- ISSUE DATE: 07/31/18
- PROJECT No.: 1350999:56
- DIVISION MGR.: MCP
- REVISIONS: 07/31/19
- 1 2018 CODE UPDATE  
NC1905NCP- 01/23/19 MCP
- 2 DIVISION REVISION  
NC1905NCP- 02/28/19 MCP
- 3 DIVISION REVISION  
NC1902NCP- 04/22/19 MCP
- 4 DIVISION REVISION  
NC1905NCP- 07/31/19 FAB

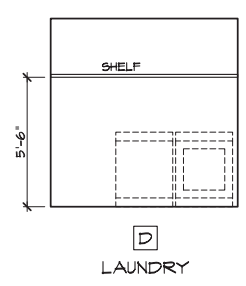
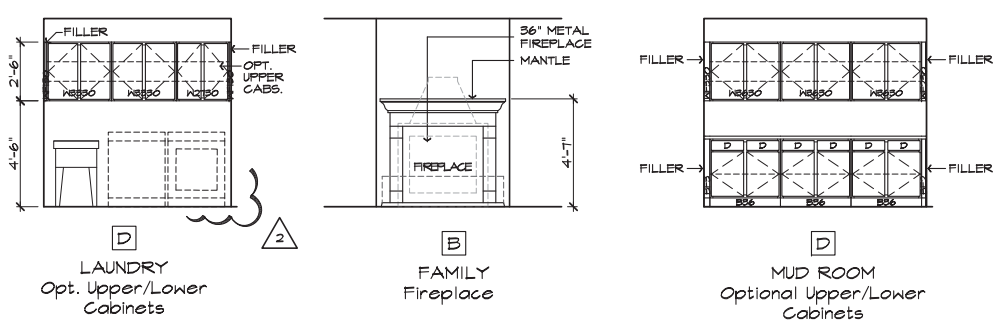

**INTERIOR ELEVATIONS**

**MISCELLANEOUS ELEVATIONS**

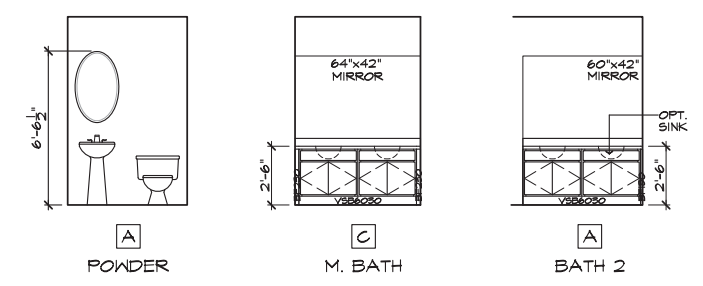
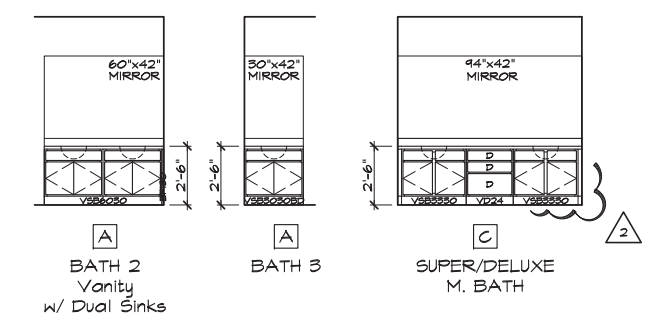

**BATH ELEVATIONS**

**BATH ELEVATIONS**

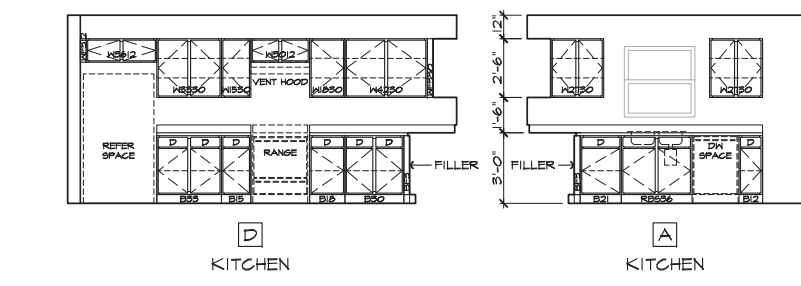
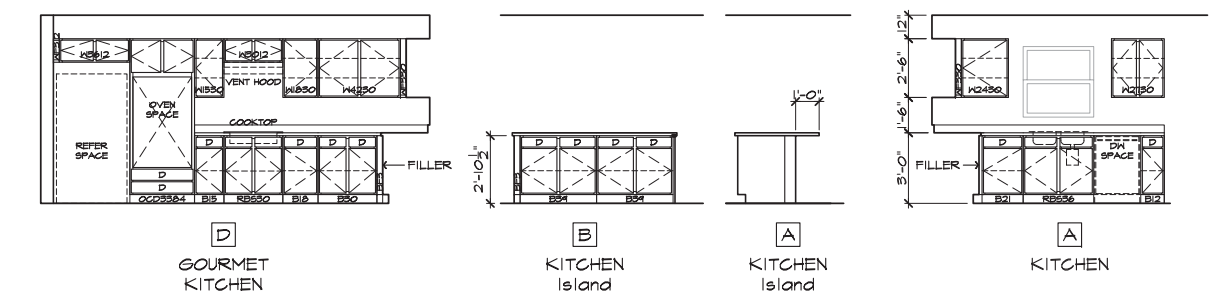

**KITCHEN ELEVATIONS**

**KITCHEN ELEVATIONS**

**OPTIONAL INTERIOR ELEVATIONS**

**STANDARD INTERIOR ELEVATIONS**

SCALE 1/4"=1'-0" (22"X34") - 1/8"=1'-0" (11"X17")

SCALE 1/4"=1'-0" (22"X34") - 1/8"=1'-0" (11"X17")

FOR INTERNAL USE ONLY

REVISION BY:	DATE:
1.	
2.	
3.	
4.	
5.	
6.	

PLAN:  
**240.3174-R**  
SHEET:  
**4.1**

**SPEC. LEVEL 1  
RALEIGH-DURHAM  
40' SERIES**

These designs and drawings are CONFIDENTIAL and the exclusive property of KB Home Corporation and are not to be disclosed without the express permission of KB Home Corporation. Copyright 2014 © KB Home Corporation. All rights reserved.



- SECTION NOTES**
- NOTE: NOT ALL KEY NOTES APPLY.
1. ROOF MATERIAL - REFER TO ROOF NOTES
  2. ROOF PITCH - REFER TO ROOF NOTES
  3. PRE-MANUFACTURED WOOD ROOF TRUSS SYSTEM - SEE STRUCTURAL & TRUSS CALCS
  4. ROOF SHEATHING PER STRUCTURAL
  5. 2x FASCIA/BARGE BOARD
  6. CONT. SOFFITED EAVE W/ VENTING
  7. G.I. FLASHING - ROOF TO WALL
  8. EXTERIOR FINISH PER ELEVATIONS
  9. FLOOR FRAMING PER STRUCTURAL
  10. FLOOR SHEATHING PER STRUCTURAL
  11. HEADER PER STRUCTURAL
  12. FLUSH BEAM PER STRUCTURAL
  13. DROPPED BEAM PER STRUCTURAL
  14. FLAT/ ARCHED SOFFIT PER PLAN
  15. 2x4 STUD WALL
  16. 2x6 STUD WALL
  17. 2x6 BALLOON FRAMED WALL PER STRUCTURAL
  18. DBL. 2x4 WALL PER PLAN
  19. 2x CRIPPLES @ 16" O.C.
  20. 2x PRESSURE TREATED SILL PLATE
  21. 2x SOLE PLATE
  22. DBL. 2x TOP PLATE @ EXTERIOR & BEARING WALLS
  23. 1x OVER 2x TOP PLATE @ INTERIOR & NON-BEARING WALLS
  24. INSULATION MATERIAL PER ENERGY CALCULATIONS
  25. MIN. 36" HIGH GUARD - SEE PLAN FOR HEIGHT
  26. LOW WALL - SEE PLAN FOR HEIGHT
  27. STAIR TREADS AND RISERS PER PLAN. - MIN. 10" TREAD & MAX. 7 5/4" RISER
  28. INTERIOR FINISH - MIN. 1/2" GYP. BD. @ WALLS & SAG RESISTANT OR 5/8" DRYWALL @ CEILING
  29. MIN. 1/2" GYP. BD. ON CEILING & WALLS @ USEABLE SPACE UNDER STAIRS.
  30. GARAGE SHALL BE SEPARATED FROM THE RESIDENCE AND ITS ATTIC AREA BY NOT LESS THAN 1/2" GYP. BD. @ GARAGE SIDE WALLS & 5/8" UNDER LIVING AREA UN.O.
  31. MATERIAL TO UNDERSIDE OF ROOF SHEATHING
  32. INTERIOR SHELF - MIN. 1/2" GYP. BD. OVER 5/8" PLY HD.
  33. CONCRETE PATIO/ PORCH SLAB PER STRUCTURAL - SLOPE 1/4" PER FT. MIN.
  34. CONCRETE GARAGE SLAB PER STRUCTURAL - SLOPE 2" MIN.
  35. CONCRETE FOUNDATION PER STRUCTURAL
  36. LINE OF OPTIONAL TRAY CEILING/ STEP CEILING
  37. LINE OF OPTIONAL VOLUME CEILING
  38. PROFILE OF OPTIONAL COVERED PATIO
  39. EXTERIOR SOFFIT MATERIAL - REFER TO ELEVATIONS.
  40. 8" BLOCK WALL
  41. 5/8" TYPE-X DRYWALL @ GARAGE CEILING
  42. WHEN THERE IS USABLE SPACE ABOVE AND BELOW THE CONCEALED SPACE OF A FLOOR-CEILING ASSEMBLY IN A SINGLE-FAMILY DWELLING, DRAFT STOPS SHALL BE INSTALLED SO THAT THE AREA OF THE CONCEALED SPACE DOES NOT EXCEED 1000 SQUARE FEET. DRAFTSTOPPINGS SHALL DIVIDE THE CONCEALED SPACE INTO APPROXIMATELY EQUAL AREAS.

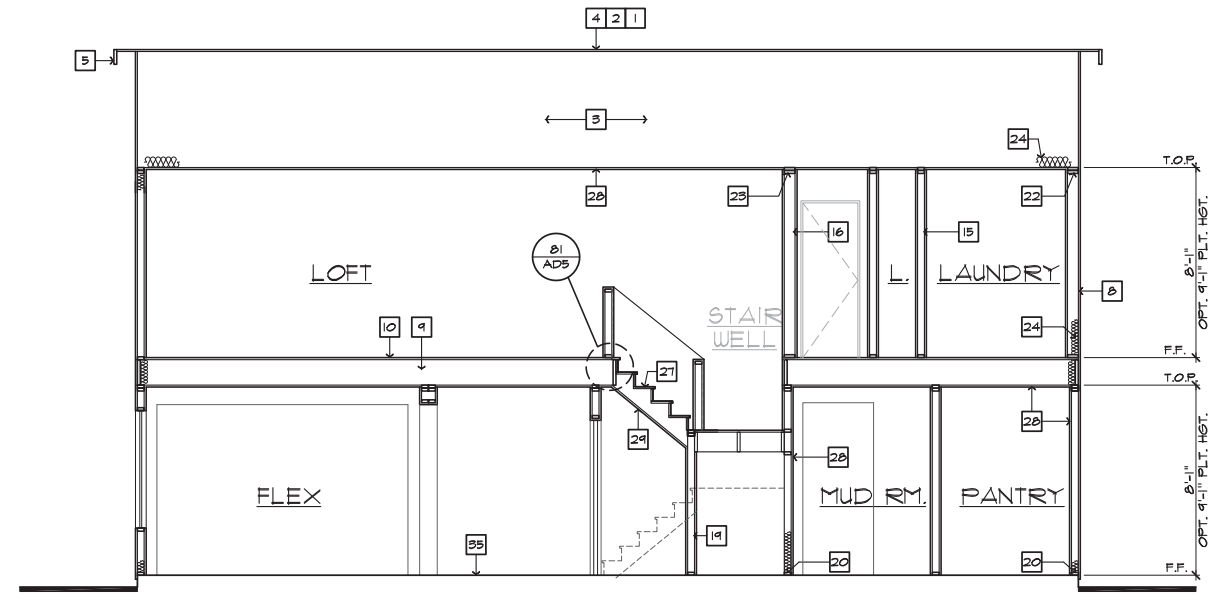

**SECTION "A"**

SCALE 1/4"=1'-0" (22'x34') - 1/8"=1'-0" (11'x17') AT SLAB-ON-GRADE

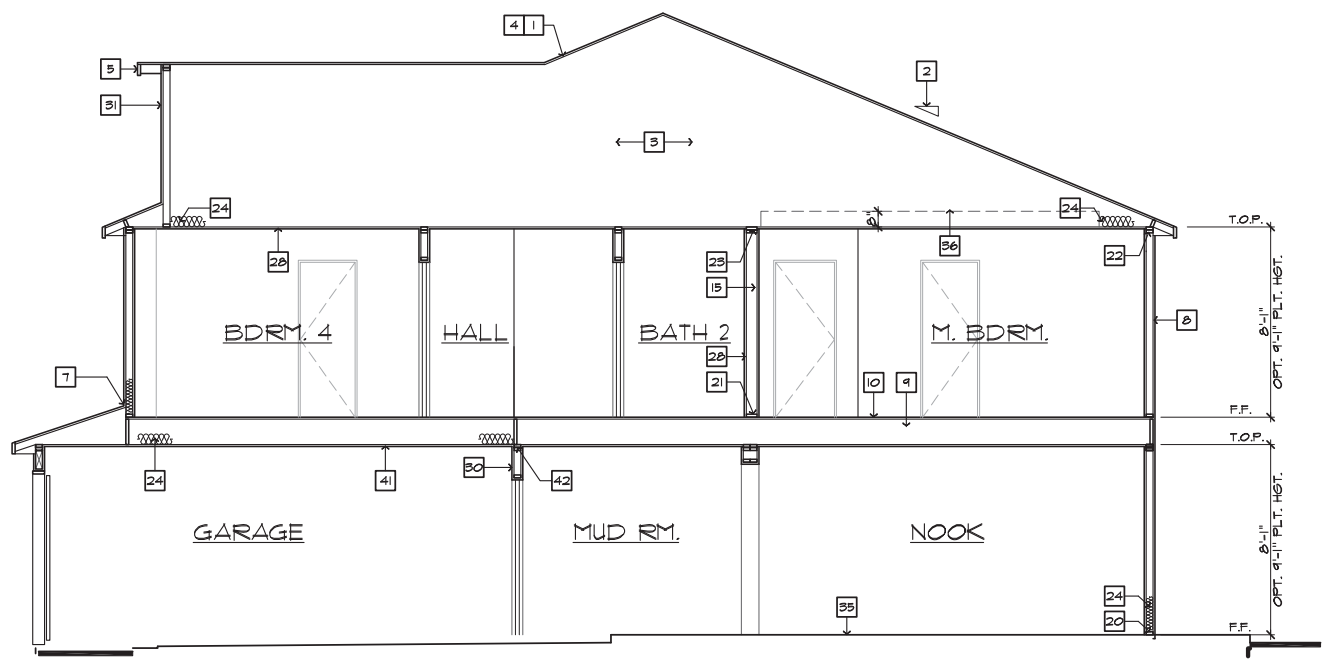

**SECTION "B"**

SCALE 1/4"=1'-0" (22'x34') - 1/8"=1'-0" (11'x17') AT SLAB-ON-GRADE

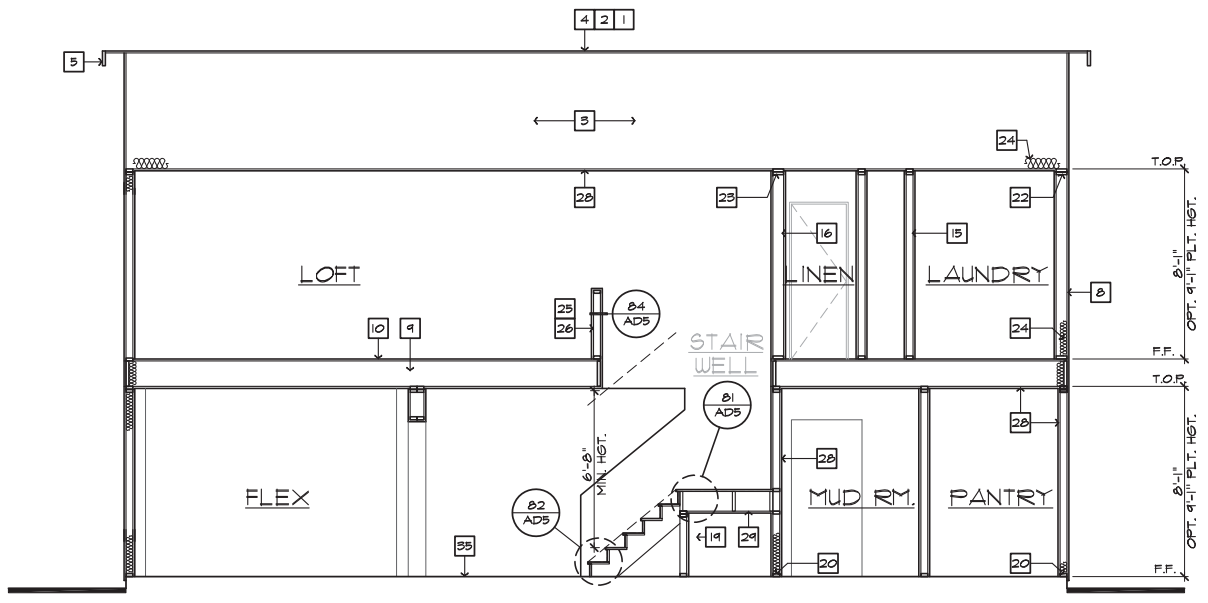

**SECTION "C"**

SCALE 1/4"=1'-0" (22'x34') - 1/8"=1'-0" (11'x17') AT SLAB-ON-GRADE

**NORTH CAROLINA 40' SERIES**

KB HOME  
NORTH CAROLINA DIVISION  
4506 S. MIAMI BLVD.  
SUITE 180  
DURHAM, NC 27703  
TEL: (919) 768-7980  
FAX: (919) 544-2928

**2018 NORTH CAROLINA STATE BUILDING CODES**

ISSUE DATE: 07/31/18  
PROJECT No.: 1350999:56  
DIVISION MGR.: MCP  
REVISIONS: 07/31/19

- 1 2018 CODE UPDATE NCI905NCP- 01/23/19 MCP
- 2 DIVISION REVISION NCI905NCP- 02/22/19 MCP
- 3 DIVISION REVISION NCI902NCP- 04/22/19 MCP
- 4 DIVISION REVISION NCI905NCP- 07/31/19 FAB

FOR INTERNAL USE ONLY	
REVISION NO.	REVISION BY

PLAN:  
**240.3174-R**  
SHEET:  
**4.2**

**SPEC. LEVEL 1  
RALEIGH-DURHAM  
40' SERIES**

These designs and drawings are CONFIDENTIAL and the exclusive property of KB Home Corporation and are not to be disclosed without the express permission of KB Home Corporation. Copyright 2014 © KB Home Corporation, all rights reserved.



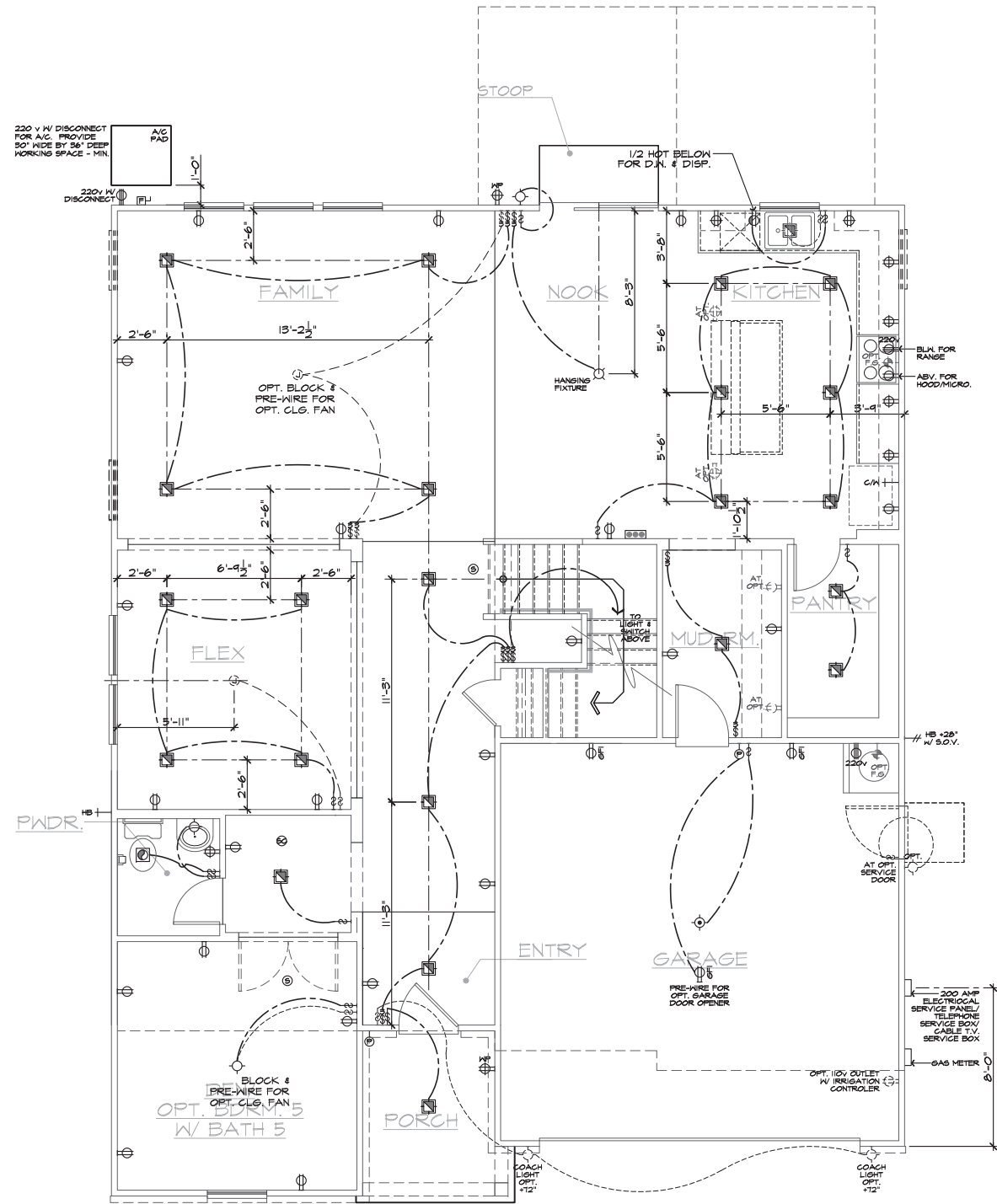

**FIRST FLOOR UTILITY PLAN**  
SCALE 1/4"=1'-0" (22"X34") - 1/8"=1'-0" (11"X17")

BASIC PLAN

UTILITY LEGEND	
	120V DUPLEX CONVENIENCE RECEPTACLE (ARC FAULT (AFCI) AND TAMPER RESISTANT (TR))
	120V (TR) RECEPTACLE W/ GFI CIRCUIT
	120V (TR) RECEPTACLE W/ GFI CIRCUIT W/ WATER RESISTANT HOUSING
	FUSED DISCONNECT
	120V (AFCI & TR) RECESSED FLOOR RECEPTACLE W/ COVER
	120V (AFCI & TR) DUPLEX CONVENIENCE RECEPTACLE SWITCH CONTROLLED, 1/2 HOT
	220V SINGLE CONVENIENCE RECEPTACLE HEIGHT NOTED AS PER PLAN
	TWO-POLE LIGHT SWITCH AT 42" ABV. FIN. FLR. 8" ABOVE COUNTER UNO.
	THREE-POLE LIGHT SWITCH
	FOUR-POLE LIGHT SWITCH
	W.P. WALL MOUNTED LIGHT FIXTURE W/ WATER RESISTANT HOUSING
	WALL MOUNTED INCANDESCENT LIGHT FIXTURE
	WALL MOUNTED FLUORESCENT LIGHT FIXTURE
	CEILING MOUNTED INCANDESCENT LIGHT FIXTURE
	CEILING MOUNTED FLUORESCENT LIGHT FIXTURE
	HANGING INCANDESCENT LIGHT FIXTURE
	RECESSED INCANDESCENT DIRECTIONAL LIGHT FIXTURE (EYE BALL)
	RECESSED INCANDESCENT LIGHT FIXTURE W/ WATER RESISTANT HOUSING
	RECESSED FLUORESCENT LIGHT FIXTURE
	RECESSED EXHAUST FAN
	RECESSED EXHAUST FAN/ INCANDESCENT LIGHT COMBINATION
	RECESSED EXHAUST FAN/ FLUORESCENT LIGHT COMBINATION
	INCANDESCENT WALL SCONCE
	ILLUMINATED ADDRESS SIGN - VISIBLE FROM STREET
	24"x48" FLUORESCENT LIGHT BOX (CEILING MOUNTED)
	12"x48" FLUORESCENT LIGHT BOX (CEILING MOUNTED)
	OPTIONAL PRE-WIRED CEILING FAN AND SWITCH - LOCATED IN CENTER OF ROOM UNO.
	CEILING MOUNTED JUNCTION BOX
	WALL MOUNTED JUNCTION BOX
	DOOR CHIME
	CATV RECEPTACLE
	PUSH BUTTON
	PHONE OUTLET
	SERVICE BOX
	HOSE BIB
	HOSE BIB W/ S.O.V.
	WATER STUB FOR ICE MAKER
	APPROVED CEILING MOUNTED SMOKE DETECTOR TO BE HARD WIRED WITH BATTERY BACK-UP AND INTERCONNECTED
	APPROVED CARBON MONOXIDE ALARM/ SMOKE DET.
	THERMOSTAT (VERIFY LOCATION W/ HVAC PLAN)
	GAS TAP
	GAS KEY - FIREPLACE GAS VALVES SHALL BE LOCATED OUTSIDE OF REQUIRED HEARTH AREA, BUT NO MORE THAN 48" FROM GAS OUTLET
	SWITCHING FOR ROOMS W/ CLG. FAN OPTIONS
	24" MIN. SEPARATION OF ELECTRICAL BOXES AS SHOWN BELOW
	Diagram showing switching options for Light/Fan and Fan
	Diagram showing 24" min separation of electrical boxes

- NOTES**
- MECHANICAL, ELECTRICAL AND PLUMBING SYSTEMS ARE SHOWN FOR INTENT ONLY. THESE SYSTEMS SHALL BE ENGINEERED BY OTHERS. THE CONTRACTOR SHALL BE RESPONSIBLE FOR PROPER INSTALLATION AND PLACEMENT. ALL HEIGHTS SHOWN ARE TO CENTERLINE OF FIXTURE.
  - PROVIDE SWITCH, LIGHT, 120V (AFCI & TR) DUPLEX RECEPTACLE & FUEL GAS STUB OR 220V RECEPTACLE IN ATTIC FOR F.A.U. - PER COMMUNITY SPECIFICATIONS.
  - SMOKE DETECTORS IN ROOMS WITH VOLUME CEILING TO BE LOCATED AT HIGHEST POINT OF CEILING.
  - 20 FOOT #4 REBAR FOR UFER GROUND AND ADDITIONAL G.O.D. WATER GROUND. REFER TO SLAB INTERFACE PLAN FOR LOCATION.
  - 200 AMP ELECTRICAL PANEL (DEFAULT). ELECTRICAL PLAN CHECK PERMIT REQUIRED IF LOAD EXCEED 400 AMPS.



**NORTH CAROLINA 40' SERIES**  
KB HOME  
NORTH CAROLINA DIVISION  
4506 S. MIAMI BLVD.  
SUITE 180  
DURHAM, NC 27703  
TEL: (919) 768-7980  
FAX: (919) 544-2928

**2018 NORTH CAROLINA STATE BUILDING CODES**

ISSUE DATE: 07/31/18  
PROJECT No.: 1350999:56  
DIVISION MGR.: MCP  
REVISIONS: 07/31/19

- 1 2018 CODE UPDATE NC19055NCP- 01/23/19 MCP
- 2 DIVISION REVISION NC19005NCP- 02/22/19 MCP
- 3 DIVISION REVISION NC19029NCP- 04/22/19 MCP
- 4 DIVISION REVISION NC19055NCP- 07/31/19 FAB

FOR INTERNAL USE ONLY	
REVISION BY:	
1.	
2.	
3.	
4.	
5.	
6.	

PLAN:  
**240.3174-R**  
SHEET:  
**5.1**

**SPEC. LEVEL 1**  
**RALEIGH-DURHAM 40' SERIES**

These designs and drawings are CONFIDENTIAL and the exclusive property of KB Home Corporation and are not to be disclosed without the express permission of KB Home Corporation. Copyright 2014 © KB Home Corporation. All rights reserved.

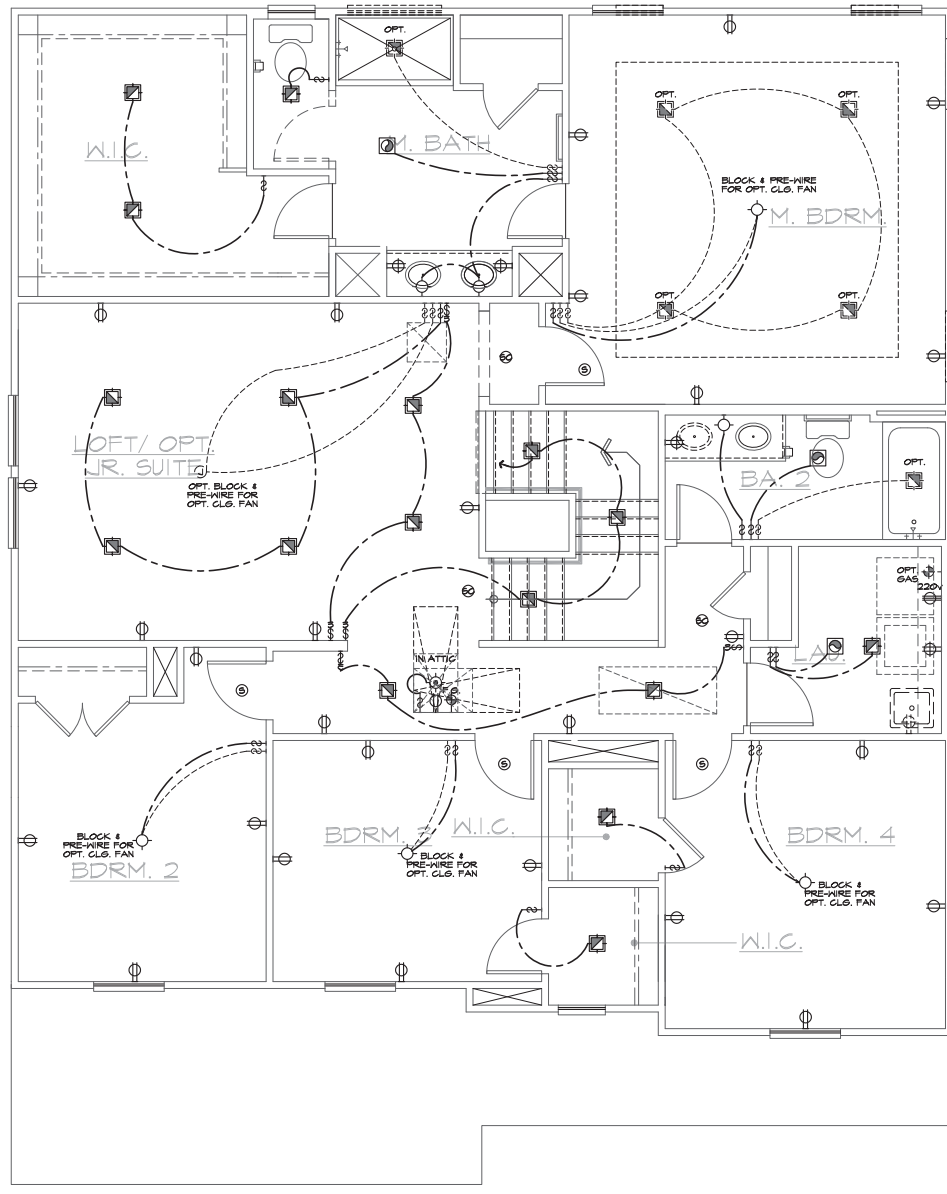

**UTILITY LEGEND**

- ⊖ 120V DUPLEX CONVENIENCE RECEPTACLE  
ARC FAULT (AFCI) AND TAMPER RESISTANT (TR)  
12" ABV. FIN. FLR. TYPICAL UNO.
- ⊖ GFI 120V (TR) RECEPTACLE W/ GFI CIRCUIT  
W/ WATER RESISTANT HOUSING
- ⊖ GFI 120V (TR) RECEPTACLE W/ GFI CIRCUIT
- ⊖ FUSED DISCONNECT
- 120V (AFCI & TR) RECESSED FLOOR  
RECEPTACLE W/ COVER
- ⊖ 120V (AFCI & TR) DUPLEX CONVENIENCE RECEPTACLE  
SWITCH CONTROLLED, 1/2 HOT
- ⊖ 220V 220V SINGLE CONVENIENCE RECEPTACLE  
HEIGHT NOTED AS PER PLAN
- ⊖ 2 TWO-POLE LIGHT SWITCH AT 42" ABV. FIN. FLR.  
8" ABOVE COUNTER UNO.
- ⊖ 3 THREE-POLE LIGHT SWITCH
- ⊖ 4 FOUR-POLE LIGHT SWITCH
- ⊖ W.P. WALL MOUNTED LIGHT FIXTURE  
W/ WATER RESISTANT HOUSING
- ⊖ WALL MOUNTED INCANDESCENT  
LIGHT FIXTURE
- ⊖ WALL MOUNTED FLUORESCENT  
LIGHT FIXTURE
- ⊖ CEILING MOUNTED INCANDESCENT  
LIGHT FIXTURE
- ⊖ CEILING MOUNTED FLUORESCENT  
LIGHT FIXTURE
- ⊖ HANGING INCANDESCENT  
LIGHT FIXTURE
- ⊖ RECESSED INCANDESCENT DIRECTIONAL  
LIGHT FIXTURE (EYE BALL)
- ⊖ RECESSED INCANDESCENT LIGHT FIXTURE  
W/ WATER RESISTANT HOUSING
- ⊖ RECESSED FLUORESCENT LIGHT FIXTURE
- ⊖ RECESSED EXHAUST FAN
- ⊖ RECESSED EXHAUST FAN/ INCANDESCENT  
LIGHT COMBINATION
- ⊖ RECESSED EXHAUST FAN/ FLUORESCENT  
LIGHT COMBINATION
- ⊖ INCANDESCENT WALL SCONCE
- ⊖ ILLUMINATED ADDRESS SIGN - VISIBLE  
FROM STREET
- ⊖ 24"x48" FLUORESCENT LIGHT  
BOX (CEILING MOUNTED)
- ⊖ 12"x48" FLUORESCENT LIGHT  
BOX (CEILING MOUNTED)
- ⊖ OPTIONAL PRE-WIRED CEILING FAN  
AND SWITCH - LOCATED IN CENTER OF ROOM UNO.
- ⊖ CEILING MOUNTED JUNCTION BOX
- ⊖ WALL MOUNTED JUNCTION BOX
- ⊖ DOOR CHIME
- ⊖ CATV RECEPTACLE
- ⊖ PUSH BUTTON
- ⊖ PHONE OUTLET
- ⊖ SERVICE BOX
- ⊖ HOSE BIB
- ⊖ HOSE BIB W/ S.O.V.
- ⊖ WATER STUB FOR ICE MAKER
- ⊖ APPROVED CEILING MOUNTED  
SMOKE DETECTOR TO BE HARD WIRED  
WITH BATTERY BACK-UP AND INTERCONNECTED
- ⊖ APPROVED CARBON MONOXIDE ALARM/ SMOKE DET.
- ⊖ THERMOSTAT (VERIFY LOCATION W/ HVAC PLAN)
- ⊖ GAS TAP
- ⊖ GAS KEY - FIREPLACE GAS VALVES SHALL BE  
LOCATED OUTSIDE OF REQUIRED HEARTH AREA,  
BUT NO MORE THAN 48" FROM GAS OUTLET

SWITCHING FOR ROOMS W/ CLG. FAN  
OPTIONS

24" MIN. SEPARATION  
OF ELECTRICAL BOXES  
AS SHOWN BELOW

CHALLENGING

2'-0" MIN.

MIN. GARAGE

**NOTES**

1. MECHANICAL, ELECTRICAL AND PLUMBING SYSTEMS ARE SHOWN FOR INTENT ONLY. THESE SYSTEMS SHALL BE ENGINEERED BY OTHERS. THE CONTRACTOR SHALL BE RESPONSIBLE FOR PROPER INSTALLATION AND PLACEMENT. ALL HEIGHTS SHOWN ARE TO CENTERLINE OF FIXTURE.
2. PROVIDE SWITCH, LIGHT, 120V (AFCI & TR) DUPLEX RECEPTACLE & FUEL GAS STUB OR 220V RECEPTACLE IN ATTIC FOR F.A.U. - PER COMMUNITY SPECIFICATIONS.
3. SMOKE DETECTORS IN ROOMS WITH VOLUME CEILING TO BE LOCATED AT HIGHEST POINT OF CEILING.
4. 20 FOOT #4 REBAR FOR UFER GROUND AND ADDITIONAL G.O.D. WATER GROUND. REFER TO SLAB INTERFACE PLAN FOR LOCATION.
5. 200 AMP ELECTRICAL PANEL (DEFAULT). ELECTRICAL PLAN CHECK PERMIT REQUIRED IF LOAD EXCEED 400 AMPS.

**SECOND FLOOR UTILITY PLAN**  
SCALE 1/4"=1'-0" (22"x34") - 1/8"=1'-0" (11"x17")

BASIC PLAN



**NORTH CAROLINA  
40' SERIES**

KB HOME  
NORTH CAROLINA DIVISION

4506 S. MIAMI BLVD.  
SUITE 180  
DURHAM, NC 27703  
TEL: (919) 768-7980  
FAX: (919) 544-2928

**2018 NORTH  
CAROLINA STATE  
BUILDING  
CODES**

ISSUE DATE: 07/31/18  
PROJECT No.: 1350999:56  
DIVISION MGR.: MCP  
REVISIONS: 07/31/19

- 1. 2018 CODE UPDATE  
NC19051NCP- 01/23/19 MCP
- 2. DIVISION REVISION  
NC19005NCP- 02/22/19 MCP
- 3. DIVISION REVISION  
NC19029NCP- 04/22/19 MCP
- 4. DIVISION REVISION  
NC19055NCP- 07/31/19 FAB

FOR INTERNAL USE ONLY

REVISION BY:	DATE:	DESCRIPTION:
1.		
2.		
3.		
4.		
5.		
6.		

PLAN:  
**240.3174-R**

SHEET:  
**5.2**

**SPEC. LEVEL 1**  
**RALEIGH-DURHAM  
40' SERIES**

These designs and drawings are CONFIDENTIAL, and the exclusive property of KB Home Corporation, and are not to be disclosed without the express permission of KB Home Corporation. Copyright 2014. © KB Home Corporation, all rights reserved.



**NORTH CAROLINA  
40' SERIES**

KB HOME  
NORTH CAROLINA DIVISION  
4506 S. MIAMI BLVD.  
SUITE 180  
DURHAM, NC 27703  
TEL: (919) 768-7980  
FAX: (919) 544-2928

**2018 NORTH  
CAROLINA STATE  
BUILDING  
CODES**

ISSUE DATE: 07/31/18  
PROJECT No.: 1350999:56  
DIVISION MGR.: MCP  
REVISIONS: 07/31/19

- 1 2018 CODE UPDATE  
NC19055NCP- 01/23/19 MCP
- 2 DIVISION REVISION  
NC19005NCP- 02/22/19 MCP
- 3 DIVISION REVISION  
NC19029NCP- 04/22/19 MCP
- 4 DIVISION REVISION  
NC19055NCP- 07/31/19 FAB

FOR INTERNAL USE ONLY	
REVISION BY:	
1.	
2.	
3.	
4.	
5.	
6.	

PLAN:  
**240.3174-R**  
SHEET:  
**5.3**

**SPEC. LEVEL 1  
RALEIGH-DURHAM  
40' SERIES**

UTILITY LEGEND	
	120V DUPLEX CONVENIENCE RECEPTACLE ARC FAULT(AFCI) AND TAMPER RESISTANT(TR) 12" ABV. FIN. FLR. TYPICAL UNO.
	120V (TR) RECEPTACLE W/ GFI CIRCUIT W/ WATER RESISTANT HOUSING
	120V (TR) RECEPTACLE W/ GFI CIRCUIT
	FUSED DISCONNECT
	120V (AFCI & TR) RECESSED FLOOR RECEPTACLE W/ COVER
	120V (AFCI & TR) DUPLEX CONVENIENCE RECEPTACLE SWITCH CONTROLLED, 1/2 HOT
	220V SINGLE CONVENIENCE RECEPTACLE HEIGHT NOTED AS PER PLAN
	TWO-POLE LIGHT SWITCH AT 42" ABV. FIN. FLR. 8" ABOVE COUNTER UNO.
	THREE-POLE LIGHT SWITCH
	FOUR-POLE LIGHT SWITCH
	W.P. WALL MOUNTED LIGHT FIXTURE W/ WATER RESISTANT HOUSING
	WALL MOUNTED INCANDESCENT LIGHT FIXTURE
	WALL MOUNTED FLUORESCENT LIGHT FIXTURE
	CEILING MOUNTED INCANDESCENT LIGHT FIXTURE
	CEILING MOUNTED FLUORESCENT LIGHT FIXTURE
	HANGING INCANDESCENT LIGHT FIXTURE
	RECESSED INCANDESCENT DIRECTIONAL LIGHT FIXTURE (EYE BALL)
	RECESSED INCANDESCENT LIGHT FIXTURE
	W.P. RECESSED INCANDESCENT LIGHT FIXTURE W/ WATER RESISTANT HOUSING
	RECESSED FLUORESCENT LIGHT FIXTURE
	RECESSED EXHAUST FAN
	RECESSED EXHAUST FAN/ INCANDESCENT LIGHT COMBINATION
	RECESSED EXHAUST FAN/ FLUORESCENT LIGHT COMBINATION
	INCANDESCENT WALL SCONCE
	ILLUMINATED ADDRESS SIGN - VISIBLE FROM STREET
	24"x48" FLUORESCENT LIGHT BOX (CEILING MOUNTED)
	12"x48" FLUORESCENT LIGHT BOX (CEILING MOUNTED)
	OPTIONAL PRE-WIRED CEILING FAN AND SWITCH - LOCATED IN CENTER OF ROOM UNO.
	CEILING MOUNTED JUNCTION BOX
	WALL MOUNTED JUNCTION BOX
	DOOR CHIME
	CATV RECEPTACLE
	PUSH BUTTON
	PHONE OUTLET
	SERVICE BOX
	HOSE BIB
	HOSE BIB W/ S.O.V.
	WATER STUB FOR ICE MAKER
	APPROVED CEILING MOUNTED SMOKE DETECTOR TO BE HARD WIRED WITH BATTERY BACK-UP AND INTERCONNECTED
	APPROVED CARBON MONOXIDE ALARM/ SMOKE DET.
	THERMOSTAT (VERIFY LOCATION W/ HVAC PLAN)
	GAS TAP
	GAS KEY - FIREPLACE GAS VALVES SHALL BE LOCATED OUTSIDE OF REQUIRED HEARTH AREA, BUT NO MORE THAN 48" FROM GAS OUTLET
	SWITCHING FOR ROOMS W/ CLS. FAN OPTIONS
	24" MIN. SEPARATION OF ELECTRICAL BOXES AS SHOWN BELOW

- NOTES**
- MECHANICAL, ELECTRICAL AND PLUMBING SYSTEMS ARE SHOWN FOR INTENT ONLY. THESE SYSTEMS SHALL BE ENGINEERED BY OTHERS. THE CONTRACTOR SHALL BE RESPONSIBLE FOR PROPER INSTALLATION AND PLACEMENT. ALL HEIGHTS SHOWN ARE TO CENTERLINE OF FIXTURE.
  - PROVIDE SWITCH, LIGHT, 120V (AFCI & TR) DUPLEX RECEPTACLE & FUEL GAS STUB OR 220V RECEPTACLE IN ATTIC FOR F.A.U. - PER COMMUNITY SPECIFICATIONS.
  - SMOKE DETECTORS IN ROOMS WITH VOLUME CEILING TO BE LOCATED AT HIGHEST POINT OF CEILING.
  - 20 FOOT #4 REBAR FOR UFER GROUND AND ADDITIONAL G.O.D. WATER GROUND. REFER TO SLAB INTERFACE PLAN FOR LOCATION.
  - 200 AMP ELECTRICAL PANEL (DEFAULT). ELECTRICAL PLAN CHECK PERMIT REQUIRED IF LOAD EXCEED 400 AMPS.

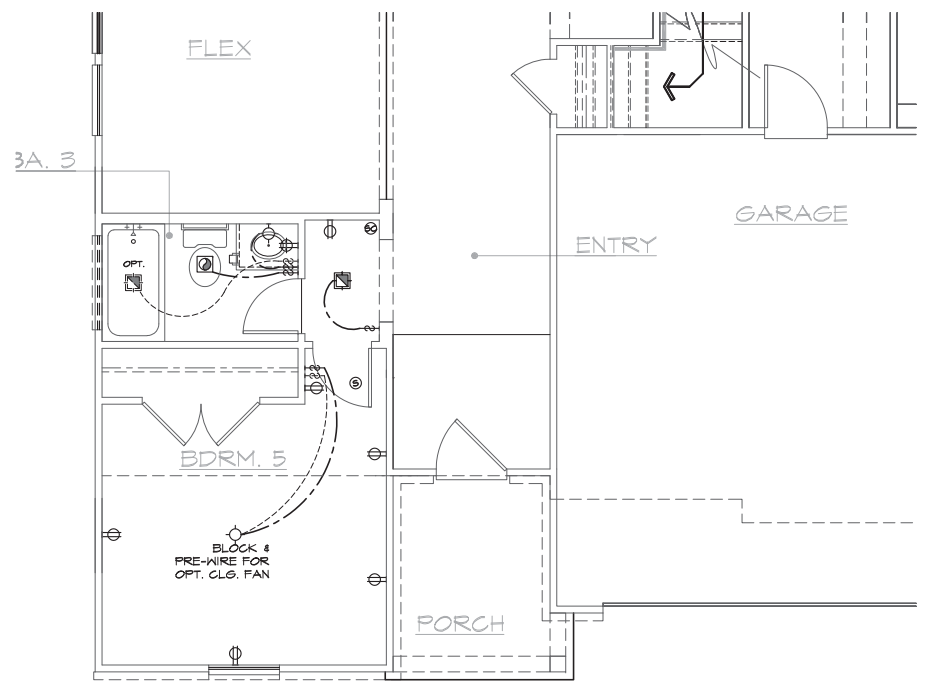

**BEDROOM 5 AND BATH 3**  
AT OPTIONAL DEN AND STORAGE

**FIRST FLOOR UTILITY PLAN OPTIONS**  
SCALE 1/4"=1'-0" (22'x34') - 1/8"=1'-0" (11'x17')

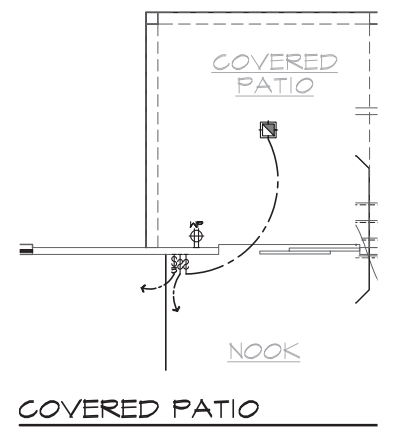

**COVERED PATIO**

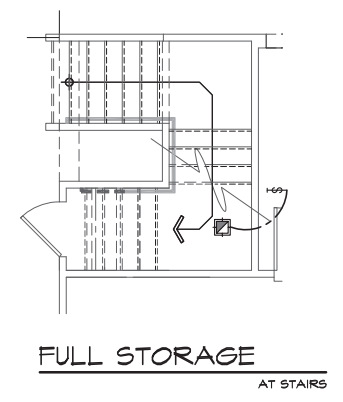

**FULL STORAGE**  
AT STAIRS

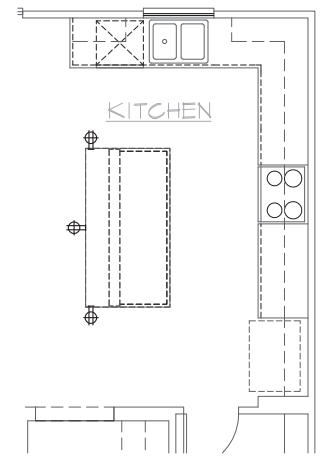

**KITCHEN ISLAND**  
AT KITCHEN

BASIC PLAN

These designs and drawings are CONFIDENTIAL and the exclusive property of KB Home Corporation and are not to be disclosed without the express permission of KB Home Corporation. Copyright 2014 © KB Home Corporation. All rights reserved.



**NORTH CAROLINA  
40' SERIES**

KB HOME  
NORTH CAROLINA DIVISION  
4506 S. MIAMI BLVD.  
SUITE 180  
DURHAM, NC 27703  
TEL: (919) 768-7980  
FAX: (919) 544-2928

**2018 NORTH  
CAROLINA STATE  
BUILDING  
CODES**

ISSUE DATE: 07/31/18  
PROJECT No.: 1350999:56  
DIVISION MGR.: MCP  
REVISIONS: 07/31/19

- 1 2018 CODE UPDATE  
NC1905NCP- 01/23/19 MCP
- 2 DIVISION REVISION  
NC1905NCP- 02/22/19 MCP
- 3 DIVISION REVISION  
NC1902NCP- 04/22/19 MCP
- 4 DIVISION REVISION  
NC1905NCP- 07/31/19 FAB

FOR INTERNAL USE ONLY	
REVISION BY:	
1.	
2.	
3.	
4.	
5.	
6.	

PLAN:  
**240.3174-R**  
SHEET:  
**5.4**

**SPEC. LEVEL 1  
RALEIGH-DURHAM  
40' SERIES**

**UTILITY LEGEND**

- ⊕ 120V DUPLEX CONVENIENCE RECEPTACLE  
ARC FAULT(AFCI) AND TAMPER RESISTANT(TR)  
12" ABV. FIN. FLR. TYPICAL UNO.
- ⊕ HP GFI 120V (TR) RECEPTACLE W/ GFI CIRCUIT  
W/ WATER RESISTANT HOUSING
- ⊕ GFI 120V (TR) RECEPTACLE W/ GFI CIRCUIT
- ⊕ FUSED DISCONNECT
- 120V (AFCI & TR) RECESSED FLOOR  
RECEPTACLE W/ COVER
- ⊕ 120V (AFCI & TR) DUPLEX CONVENIENCE RECEPTACLE  
SWITCH CONTROLLED, 1/2 HOT
- ⊕ 220 v 220V SINGLE CONVENIENCE RECEPTACLE  
HEIGHT NOTED AS PER PLAN
- ⊕-2 TWO-POLE LIGHT SWITCH AT 42" ABV. FIN. FLR.  
8" ABOVE COUNTER UNO.
- ⊕-3 THREE-POLE LIGHT SWITCH
- ⊕-4 FOUR-POLE LIGHT SWITCH
- ⊕ W.P. WALL MOUNTED LIGHT FIXTURE  
W/ WATER RESISTANT HOUSING
- ⊕ WALL MOUNTED INCANDESCENT  
LIGHT FIXTURE
- ⊕ WALL MOUNTED FLUORESCENT  
LIGHT FIXTURE
- ⊕ CEILING MOUNTED INCANDESCENT  
LIGHT FIXTURE
- ⊕ CEILING MOUNTED FLUORESCENT  
LIGHT FIXTURE
- ⊕ HANGING INCANDESCENT  
LIGHT FIXTURE
- ⊕ RECESSED INCANDESCENT DIRECTIONAL  
LIGHT FIXTURE (EYE BALL)
- ⊕ RECESSED INCANDESCENT LIGHT FIXTURE
- ⊕ W.P. RECESSED INCANDESCENT LIGHT FIXTURE  
W/ WATER RESISTANT HOUSING
- ⊕ RECESSED FLUORESCENT LIGHT FIXTURE
- ⊕ RECESSED EXHAUST FAN
- ⊕ RECESSED EXHAUST FAN/ INCANDESCENT  
LIGHT COMBINATION
- ⊕ RECESSED EXHAUST FAN/ FLUORESCENT  
LIGHT COMBINATION
- ⊕ INCANDESCENT WALL SCONCE
- ] ILLUMINATED ADDRESS SIGN - VISIBLE  
FROM STREET



24"x48" FLUORESCENT LIGHT  
BOX (CEILING MOUNTED)



12"x48" FLUORESCENT LIGHT  
BOX (CEILING MOUNTED)

- ⊕ OPTIONAL PRE-WIRED CEILING FAN  
AND SWITCH - LOCATED IN CENTER OF ROOM UNO.
- ⊕ CEILING MOUNTED JUNCTION BOX
- ⊕ WALL MOUNTED JUNCTION BOX
- ⊕ DOOR CHIME
- ⊕ CATV RECEPTACLE
- ⊕ PUSH BUTTON
- ⊕ PHONE OUTLET
- ⊕ SERVICE BOX
- ⊕ HOSE BIB
- ⊕ HOSE BIB W/ S.O.V.
- ⊕ WATER STUB FOR ICE MAKER
- ⊕ APPROVED CEILING MOUNTED  
SMOKE DETECTOR TO BE HARD WIRED  
WITH BATTERY BACK-UP AND INTERCONNECTED
- ⊕ APPROVED CARBON MONOXIDE ALARM/ SMOKE DET.
- ⊕ THERMOSTAT (VERIFY LOCATION W/ HVAC PLAN)
- ⊕ GAS TAP
- ⊕ GAS KEY - FIREPLACE GAS VALVES SHALL BE  
LOCATED OUTSIDE OF REQUIRED HEARTH AREA,  
BUT NO MORE THAN 48" FROM GAS OUTLET

SWITCHING FOR  
ROOMS W/ CLG. FAN  
OPTIONS

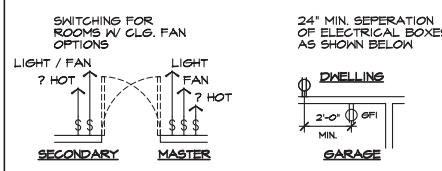

24" MIN. SEPARATION  
OF ELECTRICAL BOXES  
AS SHOWN BELOW

**NOTES**

- MECHANICAL, ELECTRICAL AND PLUMBING SYSTEMS ARE SHOWN FOR INTENT ONLY. THESE SYSTEMS SHALL BE ENGINEERED BY OTHERS. THE CONTRACTOR SHALL BE RESPONSIBLE FOR PROPER INSTALLATION AND PLACEMENT. ALL HEIGHTS SHOWN ARE TO CENTERLINE OF FIXTURE.
- PROVIDE SWITCH, LIGHT, 120V (AFCI & TR) DUPLEX RECEPTACLE & FUEL GAS STUB OR 220V RECEPTACLE IN ATTIC FOR F.A.U. - PER COMMUNITY SPECIFICATIONS.
- SMOKE DETECTORS IN ROOMS WITH VOLUME CEILING TO BE LOCATED AT HIGHEST POINT OF CEILING.
- 20 FOOT #4 REBAR FOR UFER GROUND AND ADDITIONAL GOLD WATER GROUND. REFER TO SLAB INTERFACE PLAN FOR LOCATION.
- 200 AMP ELECTRICAL PANEL (DEFAULT). ELECTRICAL PLAN CHECK PERMIT REQUIRED IF LOAD EXCEED 400 AMPS.

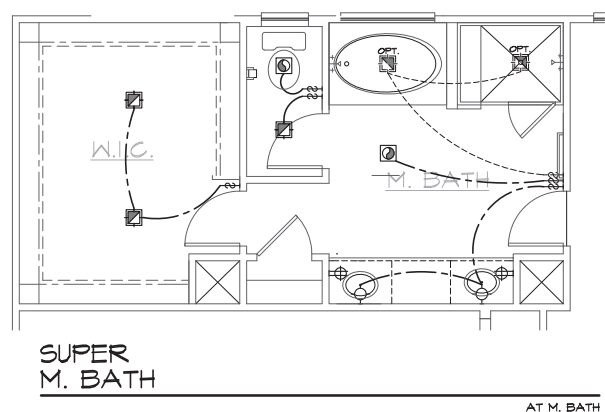
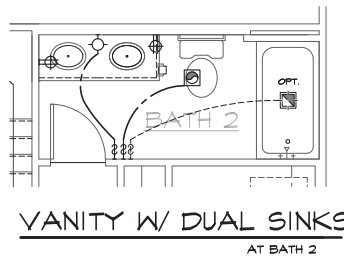
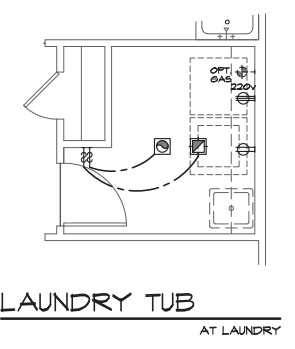

**SECOND FLOOR UTILITY PLAN OPTIONS**  
SCALE 1/4"=1'-0" (22"x34") - 1/8"=1'-0" (11"x17")

BASIC PLAN

These designs and drawings are CONFIDENTIAL and the exclusive property of KB Home Corporation and are not to be disclosed without the express permission of KB Home Corporation. Copyright 2014. © KB Home Corporation. All rights reserved.



REFER TO BASIC ELEVATION FOR INFORMATION NOT SHOWN HERE

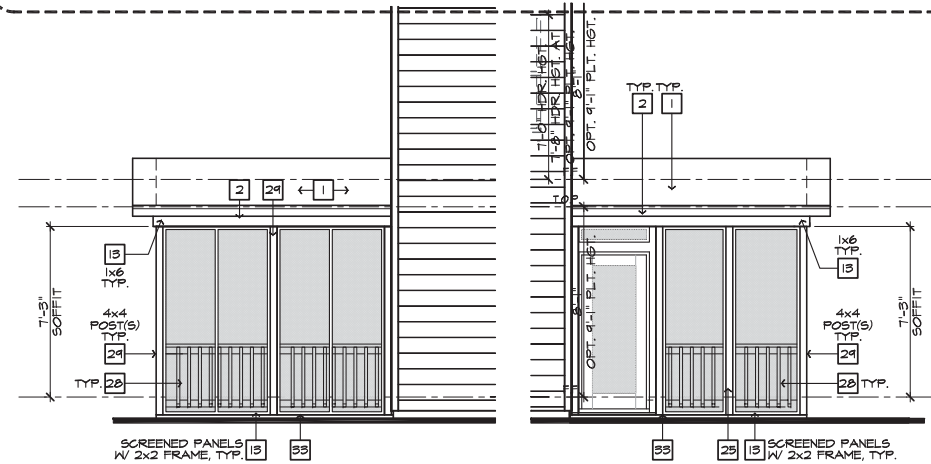

PARTIAL RIGHT ELEVATION

PARTIAL RIGHT ELEVATION

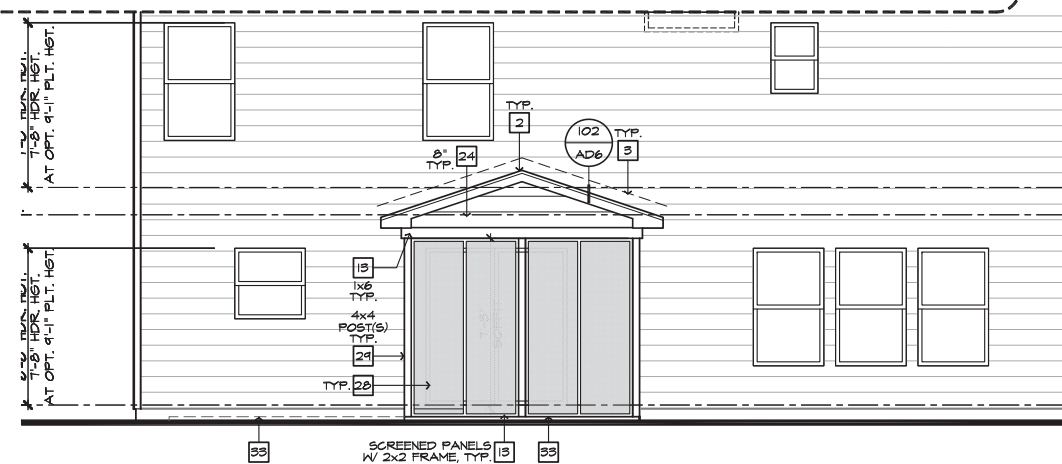

PARTIAL REAR ELEVATION

ROOF PLAN NOTES	
	INDICATES ROOF SLOPE AND DIRECTION, U.N.O.
ROOF MATERIAL: COMPOSITION SHINGLE	
12" (INCHES) TYPICAL ROOF OVERHANG AT RAKE, U.N.O.	
12" (INCHES) TYPICAL ROOF OVERHANG AT EAVE, U.N.O.	
LOCATE EAVE/ RAFTER VENTS EQUALLY BALANCED AROUND HOUSE EXCEPT ABOVE SHEARWALL PANELS.	
ATTIC VENT CALCULATIONS	
PROVIDE 1 SQ. IN. OF VENTILATION PER 500 SQ. IN. OF ATTIC SPACE. PROVIDE THAT AT LEAST 50% & NO MORE THAN 80% OF THE REQ. VENTILATING AREA IS PROVIDED BY VENTILATORS LOCATED IN THE UPPER PORTION OF THE ATTIC. (HIGH VENTING) AT 3'-0" ABOVE EAVE VENT WITH THE BALANCE BEING PROVIDED BY EAVE VENTS. (LOW VENTING)	
* CALCULATION BY 1/150, HIGH/LOW VENTING NOT REQUIRED.	
AREA 3 / OPTIONAL 10'x10' COVERED PATIO	
VENTILATION REQUIRED:	* 100 SQ. FT. / 150 = 0.67 SQ. FT. X 144 = 96.48 SQ. IN.
ATTIC AREA	
VENTILATION PROVIDED:	( 7 ) LIN. FEET OF RIDGE VENT AT (10 SQ. IN./FOOT) = 126 SQ. IN.
	(20) LIN. FEET OF VENTILATED SOFFIT (5 SQ. IN./FOOT) = 100 SQ. IN.
TOTAL VENTILATION PROVIDED:	226 SQ. IN.

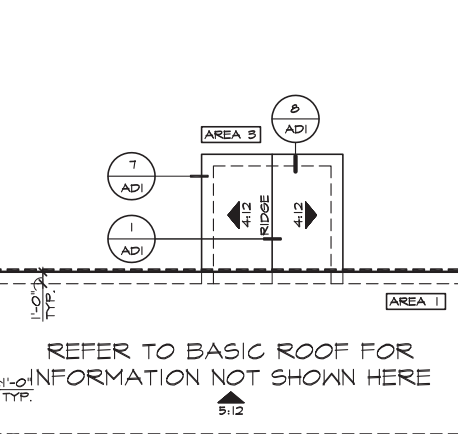

PARTIAL ROOF PLAN

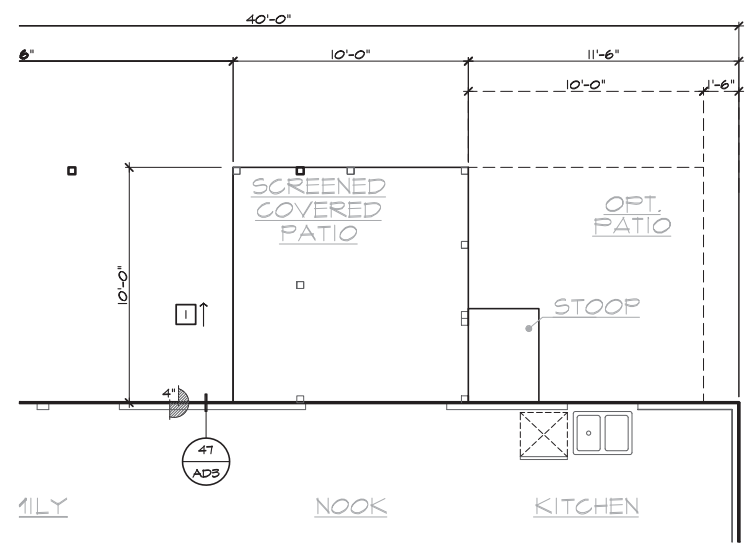

PARTIAL SLAB INTERFACE PLAN

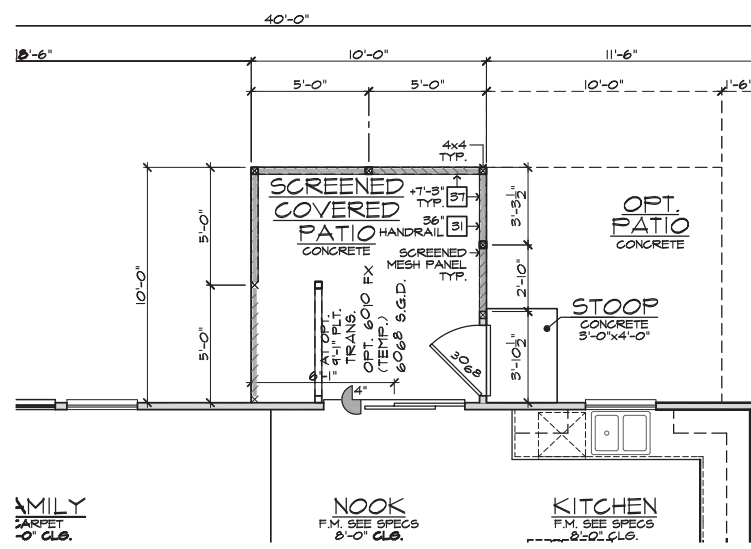

PARTIAL FIRST FLOOR PLAN

10'x10' COVERED SCREENED PATIO AT SLAB ON GRADE  
SCALE 1/4"=1'-0" (22"x34") - 1/8"=1'-0" (11"x17")

#	ELEVATION NOTES
NOTE: NOT ALL KEY NOTES APPLY.	
1.	ROOF MATERIAL - REFER TO ROOF NOTES
2.	2X FASCIA/BARGE BOARD WITH FASCIA CAP
3.	G.I. FLASHING
4.	G.I. FLASHING & SADDLE/CRICKET
5.	G.I. DRIP SCREED
6.	24"x24" CHIMNEY
7.	DECORATIVE VENT
8.	DECORATIVE CORBEL
9.	DECORATIVE SHUTTERS
10.	PEDIMENT, SEE ELEVATION FOR TYPE
11.	RECESSED ELEMENT
12.	DECORATIVE TRIM FYPON OR EQ. SEE ELEVATION FOR TYPE
13.	TRIM - SEE ELEVATION FOR SIZE
14.	SYNTHETIC MATERIAL
15.	PRE-MANUFACTURED DECORATIVE COLUMN (SIZE, SEE ELEV.) FYPON OR EQ. SURROUNDING STRUCTURAL POST.
16.	SITE-BUILT COLUMN - SEE ELEVATION FOR TYPE
17.	SHAKE SIDING
18.	STONE VENEER PER SPECS
19.	BRICK/MASONRY VENEER PER SPECS
20.	BUILT UP BRICK COLUMN
21.	SOLDIER COURSE
22.	ROYLOCK COURSE
23.	FRIEZE BOARD
24.	SIDING W/ 4" CORNER TRIM PER SPECS
25.	P.T. POST W/ WRAP - SEE STRUCTURAL FOR SIZE
26.	PRE-FAB DECORATIVE TRIM
27.	LIGHT WEIGHT PRECAST STONE TRIM
28.	RAILINGS (+36" U.N.O.)
29.	VINYL WRAP
30.	DECORATIVE WINDOW/DOOR TRIM - FYPON OR EQ. SEE ELEVATION FOR SIZE.
31.	BRACKET OR KICKER - FYPON OR EQ.
32.	ENTRY DOOR
33.	CONCRETE STOOP/ PORCH - SEE SLAB INTERFACE PLAN.
34.	SECTIONAL GARAGE DOOR PER SPECS
35.	ALUMINUM WRAP
36.	OPTIONAL DOOR/WINDOW - REFER TO PLAN OPTIONS
37.	OPTIONAL STANDING SEAM METAL ROOF
38.	KEYSTONE
39.	SOLDIER CROWN
40.	JACK SOLDIER COURSE
41.	WATER TABLE
42.	TRIUM DOOR
43.	PILASTER - SEE ELEVATION FOR TYPE

#	PARTIAL PLAN NOTES
NOTE: NOT ALL KEY NOTES APPLY.	
51.	+36" GUARD WALL DETAIL 84/AD5 OR 86/AD5
57.	FLAT SOFFIT - REFER TO PLAN OR ELEVATIONS FOR HEIGHT
58.	NOT USED
59.	LINE OF CEILING BREAK
60.	INTERIOR SHELF - REFER TO PLAN OR INT. ELEV. FOR HGT.
41.	LOW WALL - REFER TO PLAN FOR HEIGHT - DETAIL T2/AD4
45.	2x6 WALL
44.	2x6 BALLOON FRAMED WALL - REFER TO STRUCTURAL
45.	DOUBLE 2x4 WALL
46.	LINE OF FLOOR ABOVE
47.	LINE OF FLOOR BELOW
48.	EXTERIOR RAIL
55.	THE GARAGE SHALL BE SEPARATED FROM THE RESIDENCE AND ITS ATTIC AREA BY NOT LESS THAN 7" GYPSUM BOARD APPLIED TO THE GARAGE SIDE
56.	SEPARATION BETWEEN SECOND FLOOR AND GARAGE CEILING, PROVIDE (1) LAYER OF 7" TYPE "X" GYPSUM BOARD, WALLS SUPPORTING SECOND FLOOR AND GARAGE CEILING, PROVIDE (1) LAYER OF 7" GYPSUM BOARD
57.	EXTERIOR SHELF - REFER TO ELEV. FOR HEIGHT
60.	SECTIONAL GARAGE DOOR - VERIFY WINDOW OPTION

#	SLAB PLAN NOTES
NOTE: NOT ALL KEY NOTES APPLY.	
1.	CONCRETE PATIO/PORCH SLAB PER STRUCTURAL- SLOPE 1/4" PER FT. MIN.
2.	CONCRETE GARAGE SLAB PER STRUCTURAL- SLOPE 1/8" PER 1'-0" MIN. TOWARD DOOR OPENING.
3.	CONCRETE FOUNDATION PER STRUCTURAL.
4.	CONCRETE STOOP, 36"x36" STANDARD SLOPE 1/4" PER FT. MIN.
5.	CONCRETE DRIVEWAY SLOPE 1/4" PER FT. MIN. AWAY FROM GARAGE DOOR OPENING.
6.	PROVIDE ELECTRICAL CONDUIT UNDER SLAB AT ISLAND. VERIFY LOCATION.
7.	5" BRICK LEDGE FOR MASONRY VENEER.
8.	3" DIAMETER CONCRETE FILLED PIPE BOLLARD 36" HIGH WITH MIN. 12" EMBEDMENT INTO CONCRETE.
9.	REFER TO CIVIL DRAWINGS FOR ALL FINISH SURFACE ELEVATIONS.
10.	VERIFY ALL PLUMBING STUB DIMENSIONS SHOWN HERE PRIOR TO POUR OF SLAB.
11.	4" MIN. @ 1/4" MAX. TO HARD SURFACE.
12.	A/G PAD. VERIFY LOCATION.
13.	36" WIDE WALKWAY- SLOPE 1/4" PER FT. MIN.

#	FOR INTERNAL USE ONLY
1.	REVIEWED BY: _____
2.	DATE: _____
3.	BY: _____
4.	DATE: _____
5.	BY: _____
6.	DATE: _____

**NORTH CAROLINA 40' SERIES**

KB HOME  
NORTH CAROLINA DIVISION  
4506 S. MIAMI BLVD.  
SUITE 180  
DURHAM, NC 27703  
TEL: (919) 768-7980  
FAX: (919) 544-2928

**2018 NORTH CAROLINA STATE BUILDING CODES**

ISSUE DATE: 07/31/18  
PROJECT No.: 1350999:56  
DIVISION MGR.: MCP  
REVISIONS: 07/31/19

- 1. 2018 CODE UPDATES NC1905NCP- 01/23/19 MCP
- 2. DIVISION REVISION NC1905NCP- 02/22/19 MCP
- 3. DIVISION REVISION NC1902NCP- 04/22/19 MCP
- 4. DIVISION REVISION NC1905NCP- 07/31/19 FAB

#	FOR INTERNAL USE ONLY
1.	REVIEWED BY: _____
2.	DATE: _____
3.	BY: _____
4.	DATE: _____
5.	BY: _____
6.	DATE: _____

PLAN: **240.3174-R**  
SHEET: **8.3**

**SPEC. LEVEL 1 RALEIGH-DURHAM 40' SERIES**

These designs and drawings are CONFIDENTIAL, and the exclusive property of KB Home Corporation and are not to be disclosed without the express permission of KB Home Corporation. Copyright 2014 © KB Home Corporation. All rights reserved.

All I-Joist and Versa-Lam Beams  
Must be Installed per The  
Boise Cascade Installation Guide!

KB Homes  
3174 Elev C  
Lot 39 Mason Pointe

Revisions: BY:

08-25-18

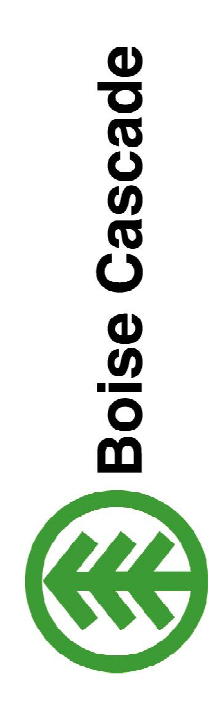
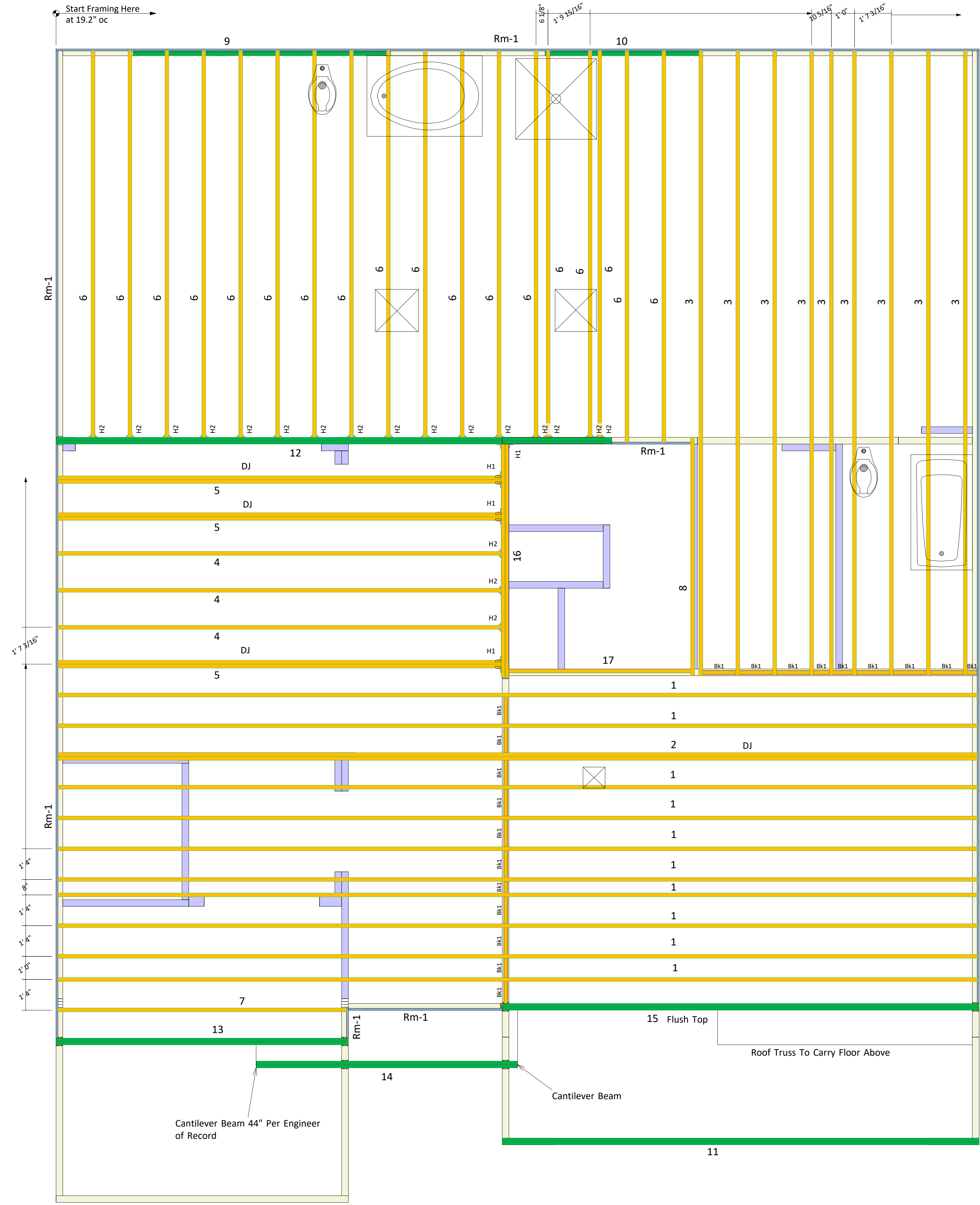
Products				
PlotID	Net Qty	Product	Length	Plies
1	10	14" BC <sup>®</sup> 5000s-1.8	40' 0"	1
2	2	14" BC <sup>®</sup> 5000s-1.8	40' 0"	2
3	9	14" BC <sup>®</sup> 5000s-1.8	28' 0"	1
4	3	14" BC <sup>®</sup> 5000s-1.8	20' 0"	1
5	6	14" BC <sup>®</sup> 5000s-1.8	20' 0"	2
6	18	14" BC <sup>®</sup> 5000s-1.8	17' 0"	1
7	1	14" BC <sup>®</sup> 5000s-1.8	13' 0"	1
8	1	14" BC <sup>®</sup> 5000s-1.8	11' 0"	1
9	2	1-3/4" x 9-1/4" VERSA-LAM <sup>®</sup> 2.0 3100 SP	12' 0"	2
10	2	1-3/4" x 9-1/4" VERSA-LAM <sup>®</sup> 2.0 3100 SP	8' 0"	2
11	2	1-3/4" x 11-7/8" VERSA-LAM <sup>®</sup> 2.0 3100 SP	22' 0"	2
12	2	1-3/4" x 14" VERSA-LAM <sup>®</sup> 2.0 3100 SP	26' 0"	2
13	2	1-3/4" x 14" VERSA-LAM <sup>®</sup> 2.0 3100 SP	14' 0"	2
14	2	1-3/4" x 14" VERSA-LAM <sup>®</sup> 2.0 3100 SP	12' 0"	2
15	2	1-3/4" x 24" VERSA-LAM <sup>®</sup> 2.0 3100 SP	22' 0"	2
16	2	14" BC <sup>®</sup> 5000s-1.8	11' 0"	2
17	1	14" BC <sup>®</sup> 5000s-1.8	8' 0"	1
Rm-1	12	1" x 14" BC RIM BOARD OSB	12' 0"	1
Bk1	12	14" BC <sup>®</sup> 5000s-1.8	2' 0"	1

Connector Summary			
PlotID	Qty	Manuf	Product
H1	4	Simpson	HU4.12/11
H2	19	Simpson	IUS2.06/14

**SALES PRESENTATION DRAWING**  
No structural or dimensional check has been made of this design drawings of the building, therefore, the user is to check all applicable dimensions, quantities, loads, and details carefully. This drawing has not been checked by Boise Engineering.

Squash Blocks Required  
Under The Ends Of All LVL  
And Point Loads For Load  
Transfer - See Details

ALL DIMENSIONS AND CONDITIONS  
TO BE REVIEWED AND APPROVED  
BY BOTH THE CONTRACTOR AND  
THE ENGINEER OF RECORD  
PRIOR TO INSTALLATION

**Second Floor Layout**

KB Homes  
3174 Elev C  
Lot 39 Mason Pointe  
84 Lumber EWP

BC FRAMER II
Plan Date: 07312018
Structural Date: 07062018
By: KOG
Sheet: 2/4

THIS LAYOUT IS INTENDED FOR THE PURPOSE OF TRUSS LOCATION AND PLACEMENT ONLY. REFER TO THE BUILDING PLANS FOR ACTUAL BUILDING CONSTRUCTION.



DEDICATED TO QUALITY AND EXCELLENCE  
 200 EMMETT ROAD  
 DUNN, NORTH CAROLINA 28334  
 PHONE: 910-892-8400  
 FAX: 910-892-8384

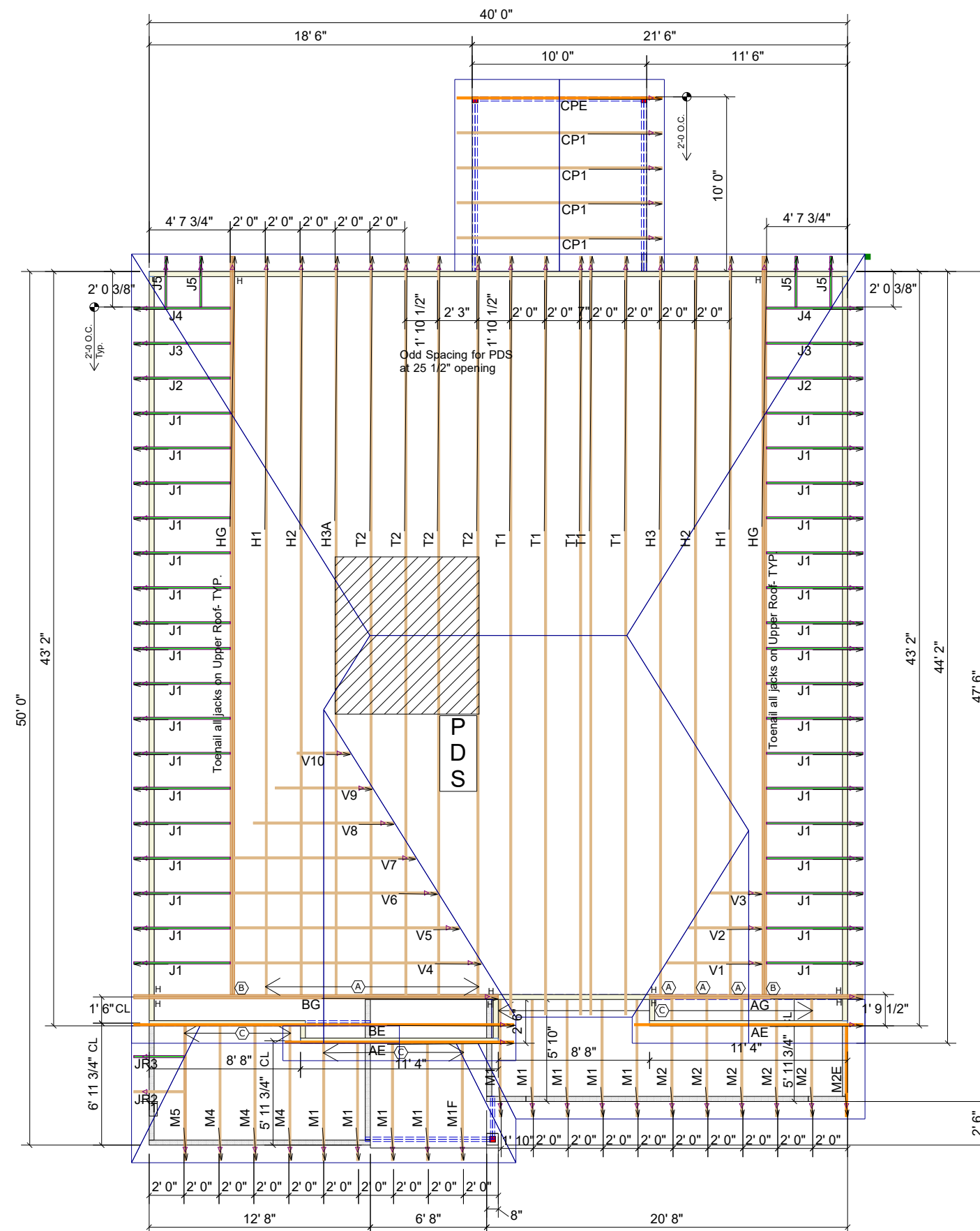
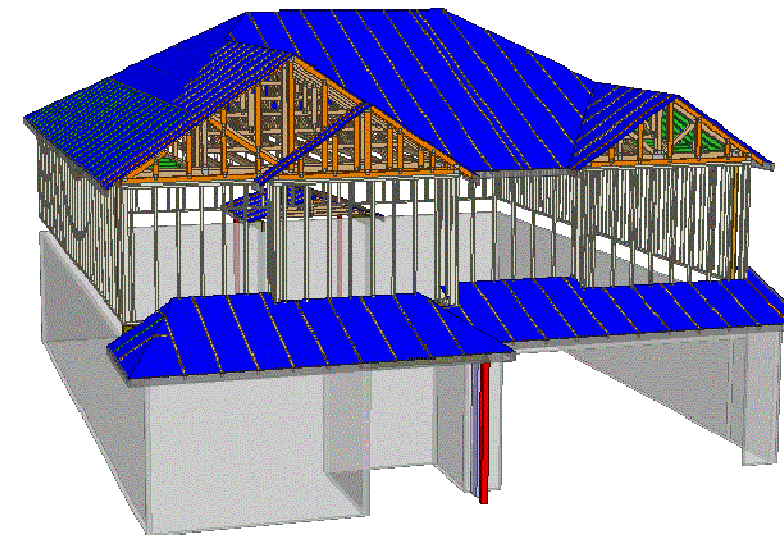

THE PURPOSE OF THIS DETAIL IS TO ILLUSTRATE HOW TO PROPERLY SPACE 24" O.C. ROOF TRUSSES TO ALLOW FOR A 25 1/2" OPENING FOR PULL DOWN ATTIC ACCESS

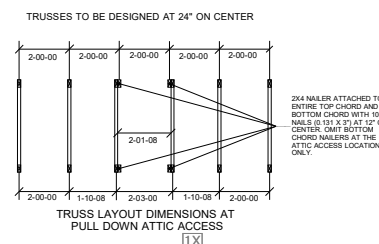

### Hardware List:

A	10	HUS26
B	2	HHUS26-2
C	19	LUS24
.	.	.
~	110	H2.5A- not supplied
H	10	HTS20
.	.	.

PROJECT:	Lot 39 @ Mason Pointe		
CUSTOMER:	KB HOME		
MODEL:	Plan 240.3174 "C" 10 x 10 CP GR		
SCALE:	NOT TO SCALE	PO #	21916
DRAWN BY:	MWM	PRINT DATE:	8/28/19
REV:	XXXXXX	SHIP DATE:	2019

TOP LIVE:	20 PSF
TOP DEAD:	10 PSF
BOTM DEAD:	10 PSF
WIND SPD:	130 MPH

**GENERAL NOTES:**  
 DO NOT CUT OR MODIFY TRUSSES.  
 TRUSSES ARE SPACED 24" ON CENTER UNLESS NOTED OTHERWISE.  
 REFER TO THE INDIVIDUAL TRUSS DESIGN DRAWINGS FOR THE LOCATION OF LATERAL BRACING AND MULTI-PLY CONNECTION REQUIREMENTS.  
 PER ANSI TPI 1-2002 THE TRUSS ENGINEER IS RESPONSIBLE FOR TRUSS TO TRUSS CONNECTIONS AND TRUSS PLY TO PLY CONNECTIONS. THIS TRUSS PLACEMENT PLAN RECOMMENDS TRUSS TO BEARING CONNECTIONS AND TRUSS TO BEAM CONNECTIONS WHICH SHALL BE REVIEWED BY THE BUILDING DESIGNER. IT IS THE RESPONSIBILITY OF THE BUILDING DESIGNER TO RESOLVE ALL ROOF FORCES ADEQUATELY TO THE FOUNDATION.

**STRUCTURAL PLANS FOR:**



**240.3174 - RH GARAGE**



**PLAN RELEASE / REVISIONS**

REV DATE	ARCH PLAN VERSION	REVISION DESCRIPTION	DRFT
08/26/2019	240.3174 RH 2019.02.28	INITIAL SETUP OF LAYOUT	CAR
08/26/2019	240.3174 RH 2019.02.28	CREATED LOT-SPECIFIC STRUCTURAL LAYOUT FROM MASTER PLAN AND EWP LAYOUT	CAR

**NOTES**

- 1. ENGINEER'S SEAL APPLIES TO STRUCTURAL COMPONENTS ONLY. ENGINEER'S SEAL DOES NOT CERTIFY DIMENSIONAL ACCURACY OR ARCHITECTURAL LAYOUT, INCLUDING ROOF GEOMETRY. JDS CONSULTING & DESIGN, PLLC ASSUMES NO LIABILITY FOR CHANGES MADE TO THESE PLANS BY OTHERS, OR FOR CONSTRUCTION METHODS, OR FOR ANY DEVIATION FROM THE PLANS. ENGINEER TO BE NOTIFIED PRIOR TO CONSTRUCTION IF ANY DISCREPANCIES ARE NOTED ON THE PLANS.
- 2. DIMENSIONS SHALL GOVERN OVER SCALE, AND CODE SHALL GOVERN OVER DIMENSIONS.
- 3. PLANS MUST HAVE SIGNED SEAL TO BE VALID AND ARE LIMITED TO THE FOLLOWING USES:
  - A. IF THESE PLANS ARE ISSUED AS A MASTER-PLAN SET, THE SET IS VALID FOR 18 MONTHS FROM THE DATE ON THE SEAL, UNLESS ANY CODE-REQUIRED UPDATES ARE PLACED IN EFFECT BY THE MUNICIPALITY.
  - B. IF THESE PLANS ARE NOT ISSUED AS A MASTER-PLAN SET, THE SET IS VALID FOR A CONDITIONAL, ONE-TIME USE FOR THE LOT OR ADDRESS SPECIFIED ON THE TITLE BLOCK.

**CODE**

ALL CONSTRUCTION, WORKMANSHIP, AND MATERIAL QUALITY AND SELECTION SHALL BE PER:

**2018  
NORTH CAROLINA  
STATE BUILDING CODE:  
RESIDENTIAL CODE**

**ENGINEER OF RECORD**

**JDS CONSULTING & DESIGN, PLLC**  
**ENGINEERING, BUILDING DESIGN, & CONSTRUCTION**  
**CONSULTING SERVICES**  
**8600 'D' JERSEY COURT**  
**RALEIGH, NC 27617**  
**PROJECT REFERENCE: 19901771**

KB HOME  
 NORTH CAROLINA DIVISION  
 4518 S. MIAMI BLVD.  
 SUITE 180  
 DURHAM, NC 27703  
 TEL: (919) 768-7988  
 FAX: (919) 472-0582



P-0961



PROJECT NO.: 19901771  
 DATE: 8/26/2019

PLAN:  
**240.3174**

TITLE SHEET

**T**

These designs and drawings are CONFIDENTIAL and the exclusive property of KB Home Corporation and are not to be disclosed without the express permission of KB Home Corporation. They may not be used or duplicated without the express permission of KB Home Corporation. Copyright 2018 © KB Home Corporation. All rights reserved.



NOTE: ALL CHAPTERS, SECTIONS, TABLES, AND FIGURES CITED WITHOUT A PUBLICATION TITLE ARE FROM THE APPLICABLE RESIDENTIAL CODE (SEE TITLE SHEET).

**GENERAL**

1. IT IS THE CONTRACTOR'S RESPONSIBILITY TO VERIFY ALL DIMENSIONS PRIOR TO CONSTRUCTION. FURTHERMORE, CONTRACTOR IS ULTIMATELY RESPONSIBLE FOR CONSTRUCTION MEANS, METHODS, AND SAFETY ON SITE. NOTIFY JDS CONSULTING & DESIGN, PLLC IMMEDIATELY IF DISCREPANCIES ON PLAN EXIST.

2. BRACED-WALL DESIGN IS BASED ON SECTION R602.10 - WALL BRACING. PRIMARY PRESCRIPTIVE METHOD TO BE CS-WSP. SEE WALL BRACING PLANS AND DETAILS FOR ADDITIONAL INFORMATION.

ALL NON-PRESCRIPTIVE SOLUTIONS ARE BASED ON GUIDELINES ESTABLISHED IN THE AMERICAN SOCIETY OF CIVIL ENGINEERS PUBLICATION ASCE 7 AND THE NATIONAL DESIGN SPECIFICATION FOR WOOD CONSTRUCTION - SPECIAL DESIGN PROVISIONS FOR WIND AND SEISMIC.

3. SEISMIC DESIGN SHALL BE PER SECTION R301.2.2 - SEISMIC PROVISIONS, INCLUDING ASSOCIATED TABLES AND FIGURES, BASED ON LOCAL SEISMIC DESIGN CATEGORY.

**DESIGN LOADS**

ASSUMED SOIL BEARING-CAPACITY 2,000 PSF

	LIVE LOAD
ULTIMATE DESIGN WIND SPEED	115 MPH, EXPOSURE B
GROUND SNOW	15 PSF
ROOF	20 PSF

RESIDENTIAL CODE TABLE R301.5	LIVE LOAD (PSF)
DWELLING UNITS	40
SLEEPING ROOMS	30
ATTICS WITH STORAGE	20
ATTICS WITHOUT STORAGE	10
STAIRS	40
DECKS	40
EXTERIOR BALCONIES	60
PASSENGER VEHICLE GARAGES	50
FIRE ESCAPES	40
GUARDS AND HANDRAILS	200 (pounds, concentrated)

COMPONENT AND CLADDING LOADS, INCLUDING THOSE FOR DOORS AND WINDOWS, SHALL BE DERIVED FROM TABLES R301.2(2) AND R301.2(3) FOR A BUILDING WITH A MEAN ROOF HEIGHT OF 35 FEET, LOCATED IN EXPOSURE B.

**ABBREVIATIONS**

ABV	ABOVE	KS	KING STUD COLUMN
AFF	ABOVE FINISHED FLOOR	LVL	LAMINATED VENEER LUMBER
ALT	ALTERNATE	MAX	MAXIMUM
BRG	BEARING	MECH	MECHANICAL
BSMT	BASEMENT	MFR	MANUFACTURER
CANT	CANTILEVER	MIN	MINIMUM
CJ	CEILING JOIST	NTS	NOT TO SCALE
CLG	CEILING	OA	OVERALL
CMU	CONCRETE MASONRY UNIT	OC	ON CENTER
CO	CASED OPENING	PT	PRESSURE TREATED
COL	COLUMN	R	RISER
CONC	CONCRETE	REF	REFRIGERATOR
CONT	CONTINUOUS	RFG	ROOFING
D	CLOTHES DRYER	RO	ROUGH OPENING
DBL	DOUBLE	RS	ROOF SUPPORT
DIAM	DIAMETER	SC	STUD COLUMN
DJ	DOUBLE JOIST	SF	SQUARE FOOT (FEET)
DN	DOWN	SH	SHELF / SHELVES
DP	DEEP	SHTG	SHEATHING
DR	DOUBLE RAFTER	SHW	SHOWER
DSP	DOUBLE STUD POCKET	SIM	SIMILAR
EA	EACH	SJ	SINGLE JOIST
EE	EACH END	SP	STUD POCKET
EQ	EQUAL	SPEC'D	SPECIFIED
EX	EXTERIOR	SQ	SQUARE
FAU	FORCED-AIR UNIT	T	TREAD
FDN	FOUNDATION	TEMP	TEMPERED GLASS
FF	FINISHED FLOOR	THK	THICK(NESS)
FLR	FLOOR(ING)	TJ	TRIPLE JOIST
FP	FIREPLACE	TOC	TOP OF CURB / CONCRETE
FTG	FOOTING	TR	TRIPLE RAFTER
HB	HOSE BIBB	TYP	TYPICAL
HDR	HEADER	UNO	UNLESS NOTED OTHERWISE
HGR	HANGER	W	CLOTHES WASHER
JS	JACK STUD COLUMN	WH	WATER HEATER
		WWF	WELDED WIRE FABRIC
		XJ	EXTRA JOIST

**MATERIALS**

1. INTERIOR / TRIMMED FRAMING LUMBER SHALL BE #2 SPRUCE PINE FIR (SPF) WITH THE FOLLOWING DESIGN PROPERTIES (#2 SOUTHERN YELLOW PINE MAY BE SUBSTITUTED):

Fb = 875 PSI Fv = 70 PSI E = 1.4E6 PSI

2. FRAMING LUMBER EXPOSED TO WEATHER OR IN CONTACT WITH THE GROUND, CONCRETE, OR MASONRY SHALL BE PRESSURE TREATED #2 SOUTHERN YELLOW PINE (SYP) WITH THE FOLLOWING DESIGN PROPERTIES:

Fb = 975 PSI Fv = 95 PSI E = 1.6E6 PSI

3. LVL STRUCTURAL MEMBERS TO BE LAMINATED VENEER LUMBER WITH THE FOLLOWING MINIMUM DESIGN PROPERTIES:

Fb = 2600 PSI Fv = 285 PSI E = 1.9E6 PSI

4. PSL STRUCTURAL MEMBERS TO BE PARALLEL STRAND LUMBER WITH THE FOLLOWING MINIMUM DESIGN PROPERTIES:

Fb = 2900 PSI Fv = 290 PSI E = 2.0E6 PSI

5. LSL STRUCTURAL MEMBERS TO BE LAMINATED STRAND LUMBER WITH THE FOLLOWING MINIMUM DESIGN PROPERTIES:

Fb = 2250 PSI Fv = 400 PSI E = 1.55E6 PSI

6. STRUCTURAL STEEL WIDE-FLANGE BEAMS SHALL CONFORM TO ASTM A992. Fy = 50 KSI

7. REBAR SHALL BE DEFORMED STEEL CONFORMING TO ASTM A615, GRADE 60.

8. POURED CONCRETE COMPRESSIVE STRENGTH TO BE A MINIMUM 3,000 PSI AT 28 DAYS. MATERIALS USED TO PRODUCE CONCRETE SHALL COMPLY WITH THE APPLICABLE STANDARDS LISTED IN AMERICAN CONCRETE INSTITUTE STANDARD ACI 318 OR ASTM C1157.

9. CONCRETE SUBJECT TO MODERATE OR SEVERE WEATHERING PROBABILITY PER TABLE R301.2(1) SHALL BE AIR-ENTRAINED WHEN REQUIRED BY TABLE R402.2.

10. CONCRETE MASONRY UNITS (CMU) SHALL CONFORM TO AMERICAN CONCRETE INSTITUTE PUBLICATION 530: BUILDING CODE REQUIREMENTS AND SPECIFICATIONS FOR MASONRY STRUCTURES AND COMPANION COMMENTARIES AND THE MASONRY SOCIETY PUBLICATION TMS 402/602: BUILDING CODE REQUIREMENTS AND SPECIFICATIONS FOR MASONRY STRUCTURES.

11. MORTAR SHALL COMPLY WITH ASTM INTERNATIONAL STANDARD C270.

12. INDICATED MODEL NUMBERS FOR ALL METAL HANGERS, STRAPS, FRAMING CONNECTORS, AND HOLD-DOWNS ARE SIMPSON STRONG-TIE BRAND. EQUIVALENT USP BRAND PRODUCTS ARE ACCEPTABLE.

13. REFER TO I-JOIST EQUIVALENCE CHART ON I-JOIST DETAIL SHEET FOR SUBSTITUTION OF MANUFACTURER SERIES.

**FOUNDATION**

1. MINIMUM ALLOWABLE SOIL BEARING CAPACITY IS ASSUMED TO BE 2,000 PSF. IT IS THE CONTRACTOR'S RESPONSIBILITY TO VERIFY SOIL BEARING CAPACITY IF UNSATISFACTORY CONDITIONS EXIST.

2. CONCRETE FOUNDATION WALLS TO BE SELECTED AND CONSTRUCTED PER SECTION R404 OR AMERICAN CONCRETE INSTITUTE STANDARD ACI 318.

3. MASONRY FOUNDATION WALLS TO BE SELECTED AND CONSTRUCTED PER SECTION R404 AND/OR AMERICAN CONCRETE INSTITUTE PUBLICATION 530: BUILDING CODE REQUIREMENTS AND SPECIFICATIONS FOR MASONRY STRUCTURES AND COMPANION COMMENTARIES AND/OR THE MASONRY SOCIETY PUBLICATION TMS 402/602: BUILDING CODE REQUIREMENTS AND SPECIFICATIONS FOR MASONRY STRUCTURES.

4. CONCRETE WALL HORIZONTAL REINFORCEMENT TO BE PER TABLE R404.1.2(1) OR AS NOTED OR DETAILED. CONCRETE WALL VERTICAL REINFORCEMENT TO BE PER TABLES R404.1.2(3 AND 4) OR AS NOTED OR DETAILED. ALL CONCRETE WALLS SHALL COMPLY WITH APPLICABLE PROVISIONS OF CHAPTER 6.

- A. TABLES ASSUME THAT WALLS HAVE PERMANENT LATERAL SUPPORT AT THE TOP AND BOTTOM.
- B. FOUNDATION DRAINS ARE ASSUMED AT ALL WALLS PER SECTION R405.

5. PLAIN-MASONRY WALL DESIGN TO BE PER TABLE R404.1.1(1) OR AS NOTED OR DETAILED. MASONRY WALLS WITH VERTICAL REINFORCEMENT TO BE PER TABLES R404.1.1 (2 THROUGH 4) OR AS NOTED OR DETAILED. ALL MASONRY WALLS SHALL COMPLY WITH APPLICABLE PROVISIONS OF CHAPTER 6.

- A. TABLES ASSUME THAT WALLS HAVE PERMANENT LATERAL SUPPORT AT THE TOP AND BOTTOM.
- B. WALL REINFORCING SHALL BE PLACED ACCORDING TO FOOTNOTE (c) OF THE TABLES (REINFORCING IS NOT CENTERED IN WALL).
- C. FOUNDATION DRAINS ARE ASSUMED AT ALL WALLS PER SECTION R405.

6. WOOD SILL PLATES TO BE ANCHORED TO THE FOUNDATION WITH 1/2" DIAMETER ANCHOR BOLTS WITH MINIMUM 7" EMBEDMENT, SPACED A MAXIMUM OF 6'-0" OC AND WITHIN 12" FROM THE ENDS OF EACH PLATE SECTION. INSTALL MINIMUM (2) ANCHOR BOLTS PER SECTION. SEE SECTION R403.1.6 FOR SPECIFIC CONDITIONS.

7. THE UNSUPPORTED HEIGHT OF SOLID MASONRY PIERS SHALL NOT EXCEED TEN TIMES THEIR LEAST DIMENSION. UNFILLED, HOLLOW PIERS MAY BE USED IF THE UNSUPPORTED HEIGHT IS NOT MORE THAN FOUR TIMES THEIR LEAST DIMENSION.

8. CENTERS OF PIERS TO BEAR IN THE MIDDLE THIRD OF THE FOOTINGS, AND GIRDERS SHALL CENTER IN THE MIDDLE THIRD OF THE PIERS.

9. ALL FOOTINGS TO HAVE MINIMUM 2" PROJECTION ON EACH SIDE OF FOUNDATION WALLS (SEE DETAILS).

10. ALL REBAR NOTED IN CONCRETE TO HAVE AT LEAST 2" COVER FROM EDGE OF CONCRETE TO EDGE OF REBAR.

11. FRAMING TO BE FLUSH WITH FOUNDATION WALLS.

12. WITH CLASS 1 SOILS, VAPOR BARRIER AND CRUSHED STONE MAY BE OMITTED.

**FRAMING**

1. ALL BEARING HEADERS TO BE (2) 2x6 SUPPORTED W/ MIN (1) JACK STUD AND (1) KING STUD EACH END, UNO.

2. ALL NON-BEARING HEADERS TO BE (2) 2x4, UNO.

3. NON-BEARING INTERIOR WALLS NOT MORE THAN 10' NOMINAL HEIGHT AND NOT SHOWN AS BRACED WALLS MAY BE FRAMED WITH 2x4 STUDS @ 24" OC.

4. SOLID BLOCKING TO BE PROVIDED AT ALL POINT LOADS THROUGH FLOOR LEVELS TO THE FOUNDATION OR TO OTHER STRUCTURAL COMPONENTS.

5. ALL BEAMS SPECIFIED ARE MINIMUM SIZES ONLY. LARGER MEMBERS MAY SUBSTITUTED AS NEEDED FOR EASE OF CONSTRUCTION.

6. ALL EXTERIOR WALLS TO BE FULLY SHEATHED WITH 7/16" OSB.

7. PORCH / PATIO COLUMNS TO BE 4x4 MINIMUM PRESSURE-TREATED LUMBER.

- A. ATTACH PORCH COLUMNS TO SLAB / FDN WALL USING ABA, ABU, ABW, OR CPT SIMPSON POST BASES TO FIT COLUMN SIZES NOTED ON PLAN -OR- ANY OTHER COLUMN CONNECTION WITH 500# UPLIFT CAPACITY.
- B. ATTACH PORCH COLUMNS TO PORCH BEAMS USING AC OR BC SIMPSON POST CAPS TO FIT COLUMN SIZES NOTED ON PLAN -OR- ANY OTHER COLUMN CONNECTION WITH 500# UPLIFT CAPACITY.
- C. TRIM OUT COLUMN(S) AND BEAM(S) PER BUILDER AND DETAILS.

8. ALL ENGINEERED WOOD PRODUCTS (LVL, PSL, LSL, ETC.) SHALL BE INSTALLED WITH CONNECTIONS PER MANUFACTURER SPECIFICATIONS.

9. ENGINEERED WOOD FLOOR SYSTEMS AND ROOF TRUSS SYSTEMS:

- A. SHOP DRAWINGS FOR THE SYSTEMS SHALL BE PROVIDED TO THE ENGINEER OF RECORD FOR REVIEW AND COORDINATION BEFORE CONSTRUCTION.
- B. TRUSS PROFILES SHALL BE SEALED BY THE TRUSS MANUFACTURER.
- C. INSTALLATION OF THE SYSTEMS SHALL BE PER MANUFACTURER'S INSTRUCTIONS.
- D. TRUSS LAYOUT AND PLACEMENT BY MANUFACTURER TO COINCIDE WITH THE SUPPORT LOCATIONS SHOWN IN THESE DRAWINGS.

10. ALL BEAMS TO BE CONTINUOUSLY SUPPORTED Laterally AND SHALL BEAR FULL WIDTH ON THE SUPPORTING WALLS OR COLUMNS INDICATED, WITH A MINIMUM OF THREE STUDS, UNO.

11. ALL STEEL BEAMS TO BE SUPPORTED AT EACH END WITH A MIN BEARING LENGTH OF 3 1/2" AND FULL FLANGE WIDTH. BEAMS MUST BE ATTACHED AT EACH END WITH A MINIMUM OF FOUR 16d NAILS OR TWO 1/2" x 4" LAG SCREWS, UNO.

12. STEEL FLITCH BEAMS TO BE BOLTED TOGETHER USING (2) ROWS OF 1/2" DIAMETER BOLTS (ASTM 307) WITH WASHERS PLACED UNDER THE THREADED END OF THE BOLT. BOLTS TO BE SPACED AT 24" OC (MAX) AND STAGGERED TOP AND BOTTOM OF BEAM (2" EDGE DISTANCE), WITH TWO BOLTS TO BE LOCATED AT 6" FROM EACH END OF FLITCH BEAM.

13. WHEN A 4-PLY LVL BEAM IS USED, ATTACH WITH (1) 1/2" DIAMETER BOLT, 12" OC, STAGGERED TOP AND BOTTOM, 1 1/2" MIN FROM ENDS. ALTERNATE EQUIVALENT ATTACHMENT METHOD MAY BE USED, SUCH AS SDS, SDW, OR TRUSSLOK SCREWS (SEE MANUFACTURER SPECIFICATIONS).

14. FOR STUD COLUMNS OF 4-OR-MORE STUDS, INSTALL SIMPSON STRONG-TIE CS16 STRAPS ACROSS STUDS @ 30" OC, 6" MAX FROM PLATES, ON INSIDE FACE OF COLUMN (EXTERIOR WALL), ON BOTH FACES OF COLUMN (INTERIOR WALL).

15. FLOOR JOISTS ADJACENT AND PARALLEL TO THE EXTERIOR FOUNDATION WALL SHALL BE PROVIDED WITH FULL-DEPTH SOLID BLOCKING, NOT LESS THAN TWO (2) INCHES NOMINAL IN THICKNESS, PLACED PERPENDICULAR TO THE JOIST AT SPACING NOT MORE THAN FOUR (4) FEET. THE BLOCKING SHALL BE NAILED TO THE FLOOR SHEATHING, THE SILL PLATE, THE JOIST, AND THE EXTERIOR RIM JOIST / BOARD.

16. BRACED WALL PANELS SHALL BE FASTENED TO MEET THE UPLIFT-RESISTANCE REQUIREMENTS IN CHAPTERS 6 AND 8 OF THE APPLICABLE CODE (SEE TITLE SHEET). REQUIREMENTS OF THE STRUCTURAL DRAWINGS THAT EXCEED THE CODE MINIMUM SHALL BE MET.



KB HOME  
NORTH CAROLINA DIVISION  
4518 S. MIAMI BLVD.  
SUITE 180  
DURHAM, NC 27703  
TEL: (919) 768-7988  
FAX: (919) 472-0582

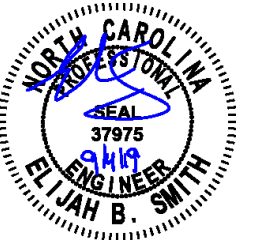

P-0961



JDS CONSULTING & DESIGN, PLLC  
8600 'D' JERSEY CT. RALEIGH, NC 27617  
919.480.1075

INFO@JDSDESIGNONLINE.COM  
WWW.JDSDESIGNONLINE.COM

PROJECT NO.: 19901771

DATE: 8/26/2019

PLAN:  
240.3174

GENERAL NOTES

**GN1.0**

These designs and drawings are CONFIDENTIAL, and the enclosure property of KB Home Corporation and are not to be disclosed without the express permission of KB Home Corporation. They may not be used or duplicated without the express permission of KB Home Corporation. Copyright 2019 © KB Home Corporation, all rights reserved.

FASTENER SCHEDULE		
CONNECTION	3" x 0.131" NAIL	3" x 0.120" NAIL
JOIST TO SILL PLATE	(4) TOE NAILS	(4) TOE NAILS
SOLE PLATE TO JOIST / BLOCKING	NAILS @ 8" OC (typical) (4) PER 16" SPACE (at braced panels)	NAILS @ 8" OC (typical) (4) PER 16" SPACE (at braced panels)
STUD TO SOLE PLATE	(4) TOE NAILS	(4) TOE NAILS
TOP OR SOLE PLATE TO STUD	(3) FACE NAILS	(4) FACE NAILS
RIM JOIST OR BAND JOIST TO TOP PLATE OR SILL PLATE	TOE NAILS @ 6" OC	TOE NAILS @ 4" OC
BLOCKING BETWEEN JOISTS TO TOP PLATE OR SILL PLATE	(4) TOE NAILS	(4) TOE NAILS
DOUBLE STUD	NAILS @ 8" OC	NAILS @ 8" OC
DOUBLE TOP PLATES	NAILS @ 12" OC	NAILS @ 12" OC
DOUBLE TOP PLATES LAP (24" MIN LAP LENGTH)	(12) NAILS IN LAPPED AREA, EA SIDE OF JOINT	(12) NAILS IN LAPPED AREA, EA SIDE OF JOINT
TOP PLATE LAP AT CORNERS AND INTERSECTING WALLS	(3) FACE NAILS	(3) FACE NAILS
OPEN-WEB TRUSS BOTTOM CHORD TO TOP PLATES OR SILL PLATE (PARALLEL TO WALL)	NAILS @ 6" OC	NAILS @ 4" OC
BOTTOM CHORD OF TRUSS TO TOP PLATES OR SILL PLATE (PERPENDICULAR TO WALL)	(3) TOE NAILS	(3) TOE NAILS

SEE TABLE R602.3(1) FOR ADDITIONAL STRUCTURAL-MEMBER FASTENING REQUIREMENTS.

DETAILS AND NOTES ON DRAWINGS GOVERN.

**BALLOON WALL FRAMING SCHEDULE**  
(USE THESE STANDARDS UNLESS NOTED OTHERWISE ON THE FRAMING PLAN SHEETS)

FRAMING MEMBER SIZE	MAX HEIGHT (PLATE TO PLATE) 115 MPH ULTIMATE DESIGN WIND SPEED
2x4 @ 16" OC	10'-0"
2x4 @ 12" OC	12'-0"
2x6 @ 16" OC	15'-0"
2x6 @ 12" OC	17'-9"
2x8 @ 16" OC	19'-0"
2x8 @ 12" OC	22'-0"
(2) 2x4 @ 16" OC	14'-6"
(2) 2x4 @ 12" OC	17'-0"
(2) 2x6 @ 16" OC	21'-6"
(2) 2x6 @ 12" OC	25'-0"
(2) 2x8 @ 16" OC	27'-0"
(2) 2x8 @ 12" OC	31'-0"

- ALL HEIGHTS ARE MEASURED SUBFLOOR TO TOP OF WALL PLATE.
- WHEN SPLIT-FRAMED WALLS ARE USED FOR HEIGHTS OVER 12', THE CONTRACTOR SHALL ADD 6' MINIMUM OF CS16 COIL STRAPPING (FULLY NAILED), CENTERED OVER THE WALL BREAK.
- FINGER-JOINTED MEMBERS MAY BE USED FOR CONTINUOUS HEIGHTS WHERE TRADITIONALLY MILLED LUMBER LENGTHS ARE LIMITED.
- FOR GREATER WIND SPEED, SEE ENGINEERED SOLUTION FOR CONDITION IN DRAWINGS.

**ROOF SYSTEMS**

**TRUSSED ROOF - STRUCTURAL NOTES**

- PROVIDE CONTINUOUS BLOCKING THROUGH STRUCTURE FOR ALL POINT LOADS.
-  DENOTES OVER-FRAMED AREA
- MINIMUM 7/16" OSB ROOF SHEATHING
- TRUSS LAYOUT AND PLACEMENT BY MANUFACTURER TO COINCIDE WITH THE SUPPORT LOCATIONS SHOWN. TRUSS PROFILES SHALL BE SEALED BY THE TRUSS MANUFACTURER. TRUSS PLANS TO BE COORDINATED WITH THE SEALED STRUCTURAL DRAWINGS. INSTALLATION SHALL BE IN ACCORDANCE WITH THE MANUFACTURER'S INSTRUCTIONS.
- MANUFACTURER TO PROVIDE REQUIRED UPLIFT CONNECTION.
- PROVIDE H2.5A (MINIMUM) OR EQUIVALENT AT EACH TRUSS-TO-TOP PLATE CONNECTION AT OVER-FRAMED AREAS, UNLESS NOTED OTHERWISE.
- UPLIFT CONNECTION TO BE CARRIED THROUGH TO FLOOR SYSTEM.

**STICK-FRAMED ROOF - STRUCTURAL NOTES**

- PROVIDE 2x4 COLLAR TIES AT 48" OC AT UPPER THIRD OF RAFTERS, UNLESS NOTED OTHERWISE.
- FUR RIDGES FOR FULL RAFTER CONTACT.
- PROVIDE CONTINUOUS BLOCKING THROUGH STRUCTURE FOR ALL POINT LOADS.
-  DENOTES OVER-FRAMED AREA
- MINIMUM 7/16" OSB ROOF SHEATHING
- PROVIDE 2x4 RAFTER TIES AT 16" OC AT 45° BETWEEN RAFTERS AND CEILING JOISTS. USE (4) 16d NAILS AT EACH CONNECTION. RAFTER TIES MAY BE SPACED AT 48" OC AT LOCATIONS WHERE NO KNEE WALLS ARE INSTALLED.
- PROVIDE H2.5A (MINIMUM) OR EQUIVALENT AT EACH RAFTER-TO-TOP PLATE CONNECTION AT OVER-FRAMED AREAS, UNLESS NOTED OTHERWISE.
- UPLIFT CONNECTION TO BE CARRIED THROUGH TO FLOOR SYSTEM.

BRICK VENEER LINTEL SCHEDULE		
SPAN	STEEL ANGLE SIZE	END BEARING LENGTH
UP TO 42"	L3-1/2"x3-1/2"x1/4"	8" (MIN. @ EACH END)
UP TO 72"	L6"x4"x5/16" (LLV)	8" (MIN. @ EACH END)
OVER 72"	L6"x4"x5/16" (LLV) ATTACH LINTEL w/ 1/2" THRU BOLT @ 12" OC, 3" FROM EACH END	

\* FOR QUEEN BRICK: LINTELS AT THIS CONDITION MAY BE 5"x3-1/2"x5/16"

NOTE: BRICK LINTELS AT SLOPED AREAS TO BE 4"x3-1/2"x1/4" STEEL ANGLE WITH 16D NAILS IN 3/16" HOLES IN 4" ANGLE LEG AT 12" OC TO TRIPLE RAFTER. WHEN THE SLOPE EXCEEDS 4:12 A MINIMUM OF 3"x3"x1/4" PLATES SHALL BE WELDED AT 24" OC ALONG THE STEEL ANGLE.



KB HOME  
NORTH CAROLINA DIVISION  
4518 S. MIAMI BLVD.  
SUITE 180  
DURHAM, NC 27703  
TEL: (919) 768-7988  
FAX: (919) 472-0582



P-0961



PROJECT NO.: 19901771  
DATE: 8/26/2019

PLAN:  
240.3174

GENERAL NOTES

**GN1.1**

These designs and drawings are CONFIDENTIAL and the enclosure property of KB Home Corporation and are not to be disclosed without the express permission of KB Home Corporation. They may not be used or duplicated without the express permission of KB Home Corporation. Copyright 2019 © KB Home Corporation, all rights reserved.

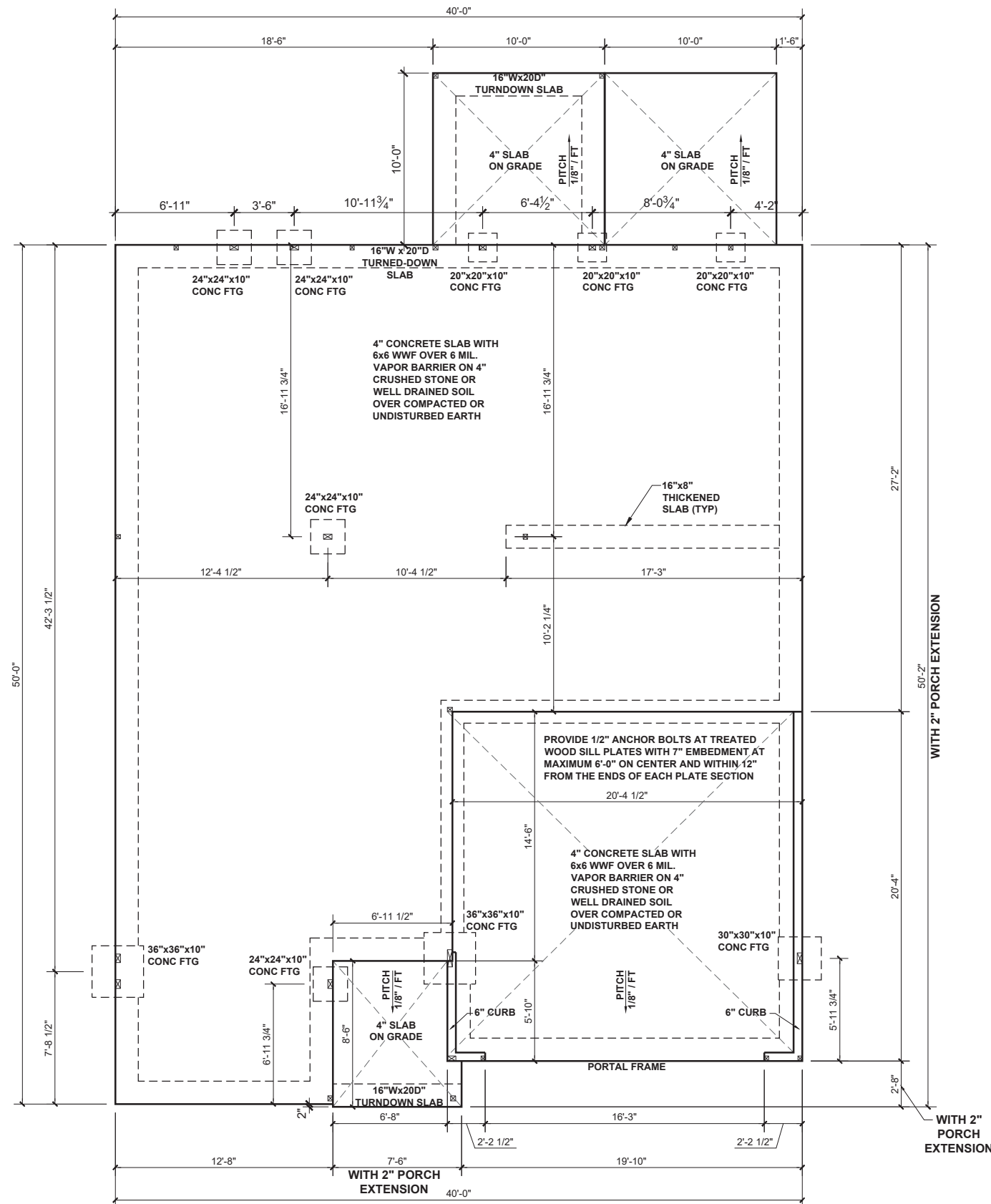

**BEAM & POINT LOAD LEGEND**

- INTERIOR LOAD BEARING WALL
- ROOF RAFTER / TRUSS SUPPORT
- DOUBLE RAFTER / DOUBLE JOIST
- STRUCTURAL BEAM / GIRDER
- WINDOW / DOOR HEADER
- POINT LOAD TRANSFER
- POINT LOAD FROM ABOVE BEARING ON BEAM / GIRDER

(1) #5 REBAR @ CENTER OFF ALL PERIMETER AND INTERNAL LOAD BEARING FOOTINGS. (2" C.C. MIN)



KB HOME  
NORTH CAROLINA DIVISION  
4518 S. MIAMI BLVD.  
SUITE 180  
DURHAM, NC 27703  
TEL: (919) 768-7988  
FAX: (919) 472-0582

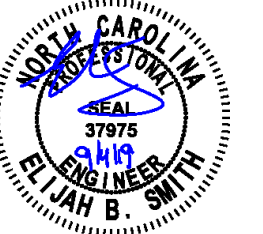

P-0961

**JDS**  
CONSULTING & DESIGN

JDS CONSULTING & DESIGN, PLLC  
8600 'D' JERSEY CT, RALEIGH, NC 27617  
919.480.1075

INFO@JDSDESIGNONLINE.COM  
WWW.JDSDESIGNONLINE.COM

PROJECT NO.: 19901771  
DATE: 8/26/2019

PLAN:  
**240.3174**

SLAB  
FOUNDATION PLAN  
**S.10C**

**SLAB FOUNDATION PLAN - 'C'**  
SCALE: 1/8" = 1'-0"

These designs and drawings are CONFIDENTIAL, and the enclosure property of KB Home Corporation and are not to be disclosed without the express permission of KB Home Corporation. They may not be used or duplicated without the express permission of KB Home Corporation. Copyright 2019 © KB Home Corporation, all rights reserved.

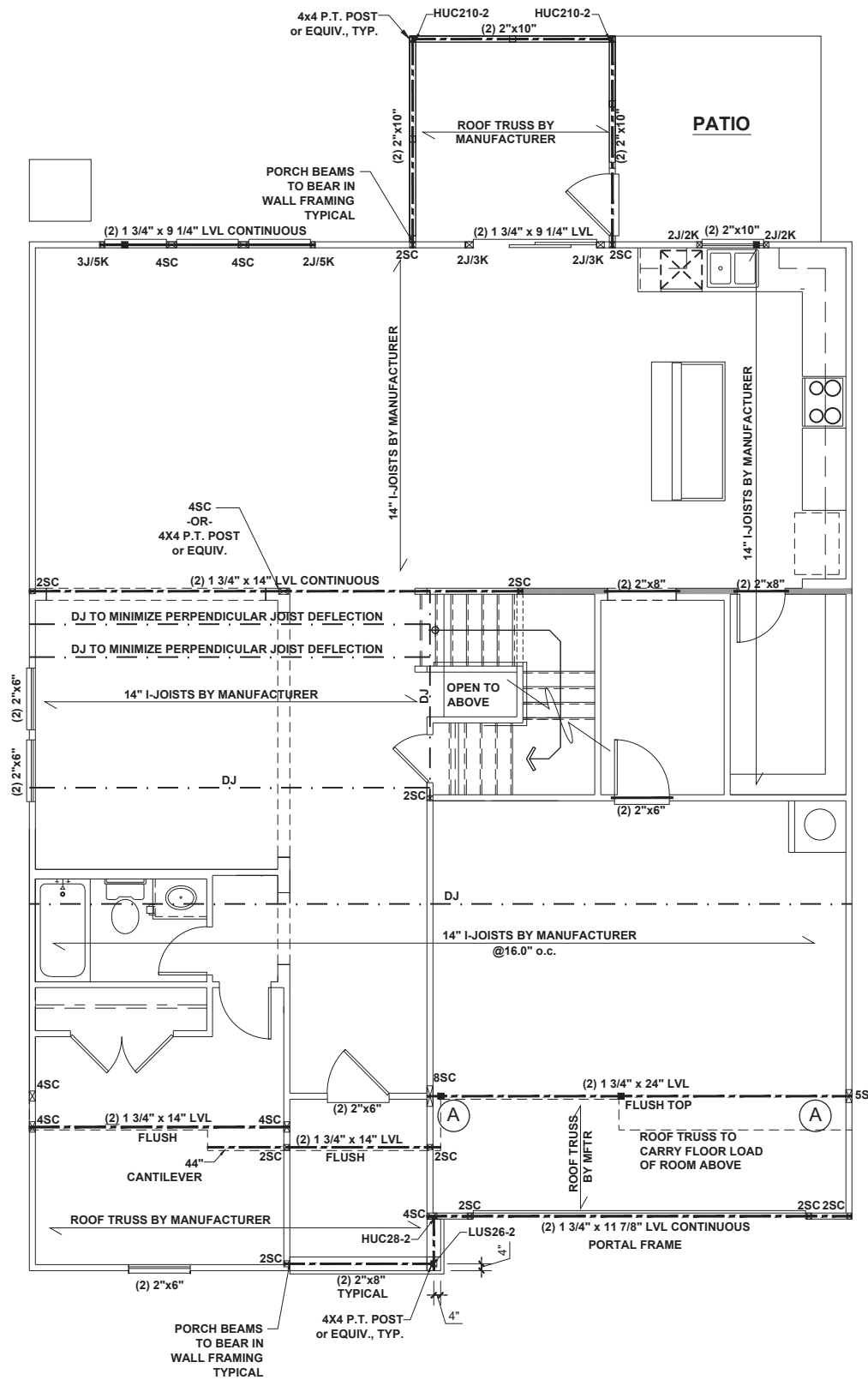

**FIRST FLOOR CEILING FRAMING PLAN - 'C'**  
 SCALE: 1/8" = 1'-0"

**BEAM & POINT LOAD LEGEND**

	INTERIOR LOAD BEARING WALL
	ROOF RAFTER / TRUSS SUPPORT
	DOUBLE RAFTER / DOUBLE JOIST
	STRUCTURAL BEAM / GIRDER
	WINDOW / DOOR HEADER
	POINT LOAD TRANSFER
	POINT LOAD FROM ABOVE BEARING ON BEAM / GIRDER

- STRUCTURAL FRAMING NOTES - (SEE GENERAL NOTES SHEET FOR ADDITIONAL REQUIREMENTS.)**
- ALL FRAMING TO BE #2 SPF MINIMUM.
  - ALL BEARING HEADERS TO BE (2) 2x6 SUPPORTED w/ MIN (1) JACK AND (1) KING EACH END, UNO.
  - EXTERIOR WALL OPENINGS OVER 3' TO HAVE MULTIPLE KING STUDS AS NOTED ON PLAN.
  - ALL NON-BEARING HEADERS TO BE (2) 2x4 (1) J / (1) K, UNO.
  - PROVIDE CONTINUOUS BLOCKING THROUGH STRUCTURE FOR ALL POINT LOADS.
  - ALL HANGERS AND CONNECTORS SPECIFIED ARE TO BE SIMPSON STRONG-TIE OR EQUIVALENT.
  - ALL BEAMS SPECIFIED ARE MINIMUM SIZES ONLY. LARGER MEMBERS MAY SUBSTITUTED AS NEEDED FOR EASE OF CONSTRUCTION. MINIMUM BEAM SUPPORT IS (1) 2x4 STUD.
  - ALL EXTERIOR WALLS TO BE FULLY SHEATHED WITH 7/16" OSB.
  - FRONT PORCH COLUMNS TO BE MIN 4x4 PT ATTACHED AT TOP AND BOTTOM USING SIMPSON (OR EQUIV) COLUMN BASE OR SST A24 BRACKETS. TRIM OUT PER BUILDER.
  - PORCH COLUMNS TO BE MIN 4x4 PT ATTACHED AT BOTTOM USING SIMPSON (OR EQUIV) ABA44 AND AT TOP USING CS 16 STRAPPING (12" MIN) TO PORCH HEADER / BAND.
  - WHEN A 4-PLY LVL IS USED, ATTACH WITH (1) 1/2" Ø BOLT 12" OC STAGGERED, TOP AND BOTTOM, 1-1/2" MIN FROM ENDS. ALTERNATE ATTACHMENT EQUIVALENT METHOD MAY BE USED, SUCH AS SDW OR TRUSSLOK SCREWS (SEE MANUFACTURER'S SPECIFICATIONS).
  - FOR STUD COLUMNS OF 4 OR MORE, INSTALL SST CS16 STRAPS @ 30" OC, 6" MAX FROM PLATES, ON INSIDE FACE OF COLUMN (EXTERIOR WALL), ON BOTH FACES OF COLUMN (INTERIOR WALL).

I-JOIST SPACING NOT TO EXCEED 19.2" OC IN LOCATIONS WITH TILE FINISH FLOOR

ALL FLUSH BEAMS TO BE DIRECTLY SUPPORTED BY (2) 2x STUDS UNLESS OTHERWISE NOTED. STUD COLUMNS TO BE SUPPORTED BY SOLID BLOCKING TO FOUNDATION OR TO BEARING COMPONENT BELOW.

FLOOR FRAMING TO BE 14" DEEP TJI 210 SERIES OR EQUAL, 19.2" OC MAXIMUM SPACING, U.N.O.

\*\*REFER TO I-JOIST EQUIVALENCE CHART ON I-JOIST DETAIL SHEET FOR SUBSTITUTION OF MANUFACTURER SERIES

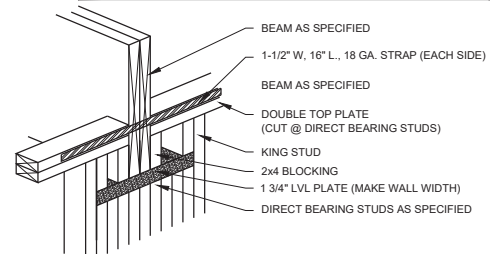

**(A) DIRECT STUD BEARING**  
 DROPPED SINGLE LVL PLATE NTS



KB HOME  
 NORTH CAROLINA DIVISION  
 4518 S. MIAMI BLVD.  
 SUITE 180  
 DURHAM, NC 27703  
 TEL: (919) 768-7988  
 FAX: (919) 472-0582



P-0961

**JDS**  
 CONSULTING & DESIGN

JDS CONSULTING & DESIGN, PLLC  
 8600 'D' JERSEY CT, RALEIGH, NC 27617  
 919.480.1075

INFO@JDSDESIGNONLINE.COM  
 WWW.JDSDESIGNONLINE.COM

PROJECT NO.: 19901771  
 DATE: 8/26/2019

PLAN:  
**240.3174**

FIRST FLOOR  
 CEILING FRAMING PLAN  
**S1.0C**

These designs and drawings are CONFIDENTIAL and the exclusive property of KB Home Corporation and are not to be disclosed without the express permission of KB Home Corporation. Copyright 2019 © KB Home Corporation, all rights reserved.

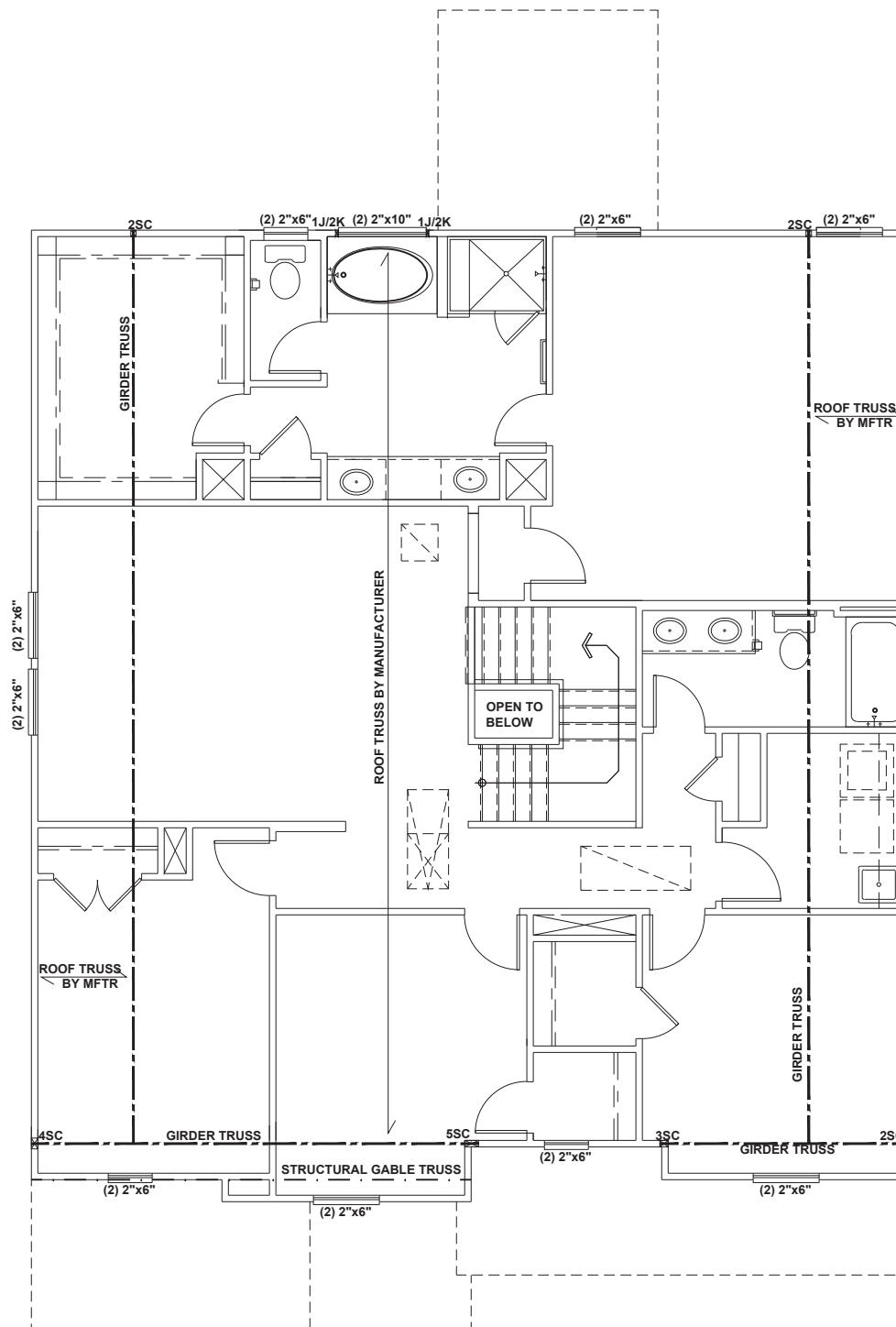

**BEAM & POINT LOAD LEGEND**

	INTERIOR LOAD BEARING WALL
	ROOF RAFTER / TRUSS SUPPORT
	DOUBLE RAFTER / DOUBLE JOIST
	STRUCTURAL BEAM / GIRDER
	WINDOW / DOOR HEADER
	POINT LOAD TRANSFER
	POINT LOAD FROM ABOVE BEARING ON BEAM / GIRDER

- STRUCTURAL FRAMING NOTES - (SEE GENERAL NOTES SHEET FOR ADDITIONAL REQUIREMENTS.)**
- ALL FRAMING TO BE #2 SPF MINIMUM.
  - ALL BEARING HEADERS TO BE (2) 2x6 SUPPORTED w/ MIN (1) JACK AND (1) KING EACH END, UNO.
  - EXTERIOR WALL OPENINGS OVER 3' TO HAVE MULTIPLE KING STUDS AS NOTED ON PLAN.
  - ALL NON-BEARING HEADERS TO BE (2) 2x4 (1) J / (1) K, UNO.
  - PROVIDE CONTINUOUS BLOCKING THROUGH STRUCTURE FOR ALL POINT LOADS.
  - ALL HANGERS AND CONNECTORS SPECIFIED ARE TO BE SIMPSON STRONG-TIE OR EQUIVALENT.
  - ALL BEAMS SPECIFIED ARE MINIMUM SIZES ONLY. LARGER MEMBERS MAY SUBSTITUTED AS NEEDED FOR EASE OF CONSTRUCTION. MINIMUM BEAM SUPPORT IS (1) 2x4 STUD.
  - ALL EXTERIOR WALLS TO BE FULLY SHEATHED WITH 7/16" OSB.
  - FRONT PORCH COLUMNS TO BE MIN 4x4 PT ATTACHED AT TOP AND BOTTOM USING SIMPSON (OR EQUIV) COLUMN BASE OR SST A24 BRACKETS. TRIM OUT PER BUILDER.
  - PORCH COLUMNS TO BE MIN 4x4 PT ATTACHED AT BOTTOM USING SIMPSON (OR EQUIV) ABA44 AND AT TOP USING CS 16 STRAPPING (12" MIN) TO PORCH HEADER / BAND.
  - WHEN A 4-PLY LVL IS USED, ATTACH WITH (1) 1/2" Ø BOLT 12" OC STAGGERED, TOP AND BOTTOM, 1-1/2" MIN FROM ENDS. ALTERNATE ATTACHMENT EQUIVALENT METHOD MAY BE USED, SUCH AS SDW OR TRUSSLOK SCREWS (SEE MANUFACTURER'S SPECIFICATIONS).
  - FOR STUD COLUMNS OF 4 OR MORE, INSTALL SST CS16 STRAPS @ 30" OC, 6" MAX FROM PLATES, ON INSIDE FACE OF COLUMN (EXTERIOR WALL), ON BOTH FACES OF COLUMN (INTERIOR WALL).

ALL FLUSH BEAMS TO BE DIRECTLY SUPPORTED BY (2) 2X STUDS UNLESS OTHERWISE NOTED. STUD COLUMNS TO BE SUPPORTED BY SOLID BLOCKING TO FOUNDATION OR TO BEARING COMPONENT BELOW.

**SECOND FLOOR CEILING FRAMING PLAN - 'C'**  
 SCALE: 1/8" = 1'-0"



KB HOME  
 NORTH CAROLINA DIVISION  
 4518 S. MIAMI BLVD.  
 SUITE 180  
 DURHAM, NC 27703  
 TEL: (919) 768-7988  
 FAX: (919) 472-0582



P-0961

**JDS**  
 CONSULTING & DESIGN

JDS CONSULTING & DESIGN, PLLC  
 8600 'D' JERSEY CT, RALEIGH, NC 27617  
 919.480.1075

INFO@JDSDESIGNONLINE.COM  
 WWW.JDSDESIGNONLINE.COM

PROJECT NO.: 19901771  
 DATE: 8/26/2019

PLAN:  
**240.3174**

SECOND FLOOR  
 CEILING FRAMING PLAN

**S2.0C**

These designs and drawings are CONFIDENTIAL and the exclusive property of KB Home Corporation and are not to be disclosed without the express permission of KB Home Corporation. They may not be used or duplicated without the express permission of KB Home Corporation. Copyright 2019 © KB Home Corporation, all rights reserved.

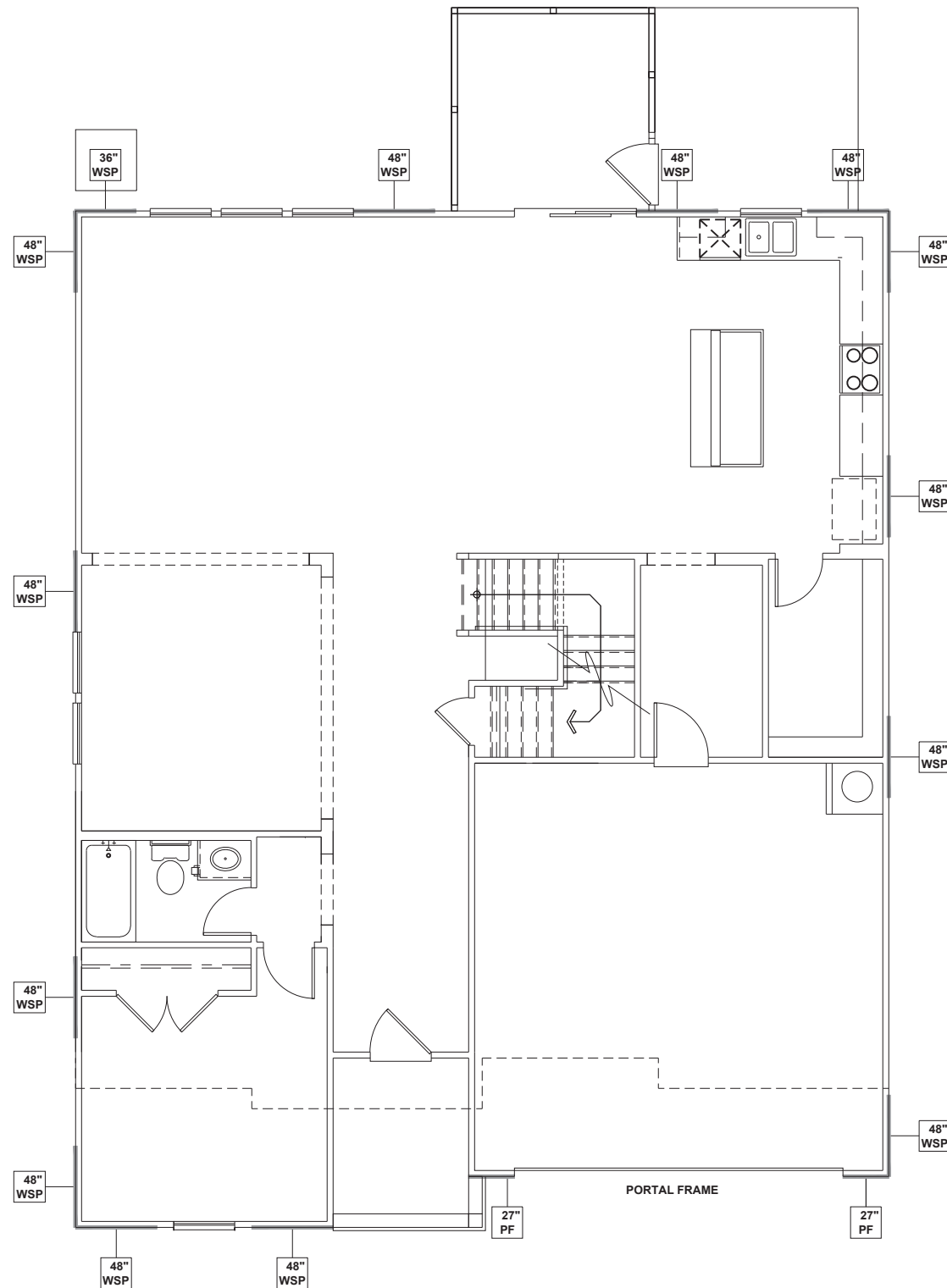

**FIRST FLOOR WALL BRACING PLAN - 'C'**  
 SCALE: 1/8" = 1'-0"

**WALL BRACING REQUIREMENTS**

- MINIMUM PANEL WIDTH IS 24"
- FIGURES BASED ON THE CONTINUOUS SHEATHING METHOD USING THE RECTANGLE CIRCUMSCRIBED AROUND THE FLOOR PLAN OR PORTION OF THE FLOOR PLAN. IF NO RECTANGLE IS NOTED, THE STRUCTURE HAS BEEN FIGURED ALL WITHIN ONE RECTANGLE.
- PANELS MAY SHIFT UP TO 36" EITHER DIRECTION FOR EASE OF CONSTRUCTION (NAILING & BLOCK REQUIREMENTS STILL APPLY).
- FOR ADDITIONAL WALL BRACING INFORMATION, REFER TO WALL BRACING DETAIL SHEET(S).
- SCHEMATIC BELOW INDICATES HOW SIDES OF RECTANGLE ARE TO BE INTERPRETED IN BRACING CHART WHEN APPLIED TO STRUCTURE:

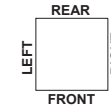

- ◆ CS16 STRAP FROM STUD, CROSS HEADER, TO WALL TOP PLATE, 36" LONG MINIMUM
- ▶ SIMPSON MSTA15 HOLD DOWN CAPACITY OF 970 POUNDS PER ANCHOR WITH (12) 10d NAILS. STRAP TO BE LOCATED AT EDGE OF BRACED WALL PANEL. (CS16 STRAPPING MAY BE SUBSTITUTED w/ SIMILAR LENGTH AND NAILING PATTERN.) USE HTT4 FOR ATTACHMENT TO CONCRETE.

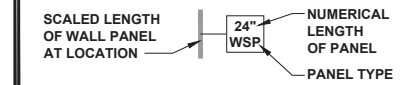

**WALL BRACING NOTE:**

WALLS WITH REQUIRED LENGTH LISTED AS "N/A" DO NOT MEET THE REQUIREMENTS OF PRESCRIPTIVE WALL BRACING FOUND IN THE NCRC. THESE WALLS HAVE BEEN ENGINEERED BASED ON DESIGN GUIDELINES ESTABLISHED IN ASCE-07 AND THE NDS: WIND & SEISMIC PROVISIONS SUPPLEMENT.

**WALL BRACING: RECTANGLE 1**

SIDE	REQUIRED LENGTH	PROVIDED LENGTH
FRONT	13.5 FT.	14.75 FT.
LEFT	11.0 FT.	16.0 FT.
REAR	13.5 FT.	15.0 FT.
RIGHT	11.0 FT.	16.0 FT.



KB HOME  
 NORTH CAROLINA DIVISION  
 4518 S. MIAMI BLVD.  
 SUITE 180  
 DURHAM, NC 27703  
 TEL: (919) 768-7988  
 FAX: (919) 472-0582

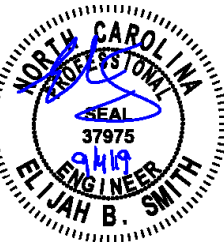

P-0961



JDS CONSULTING & DESIGN, PLLC  
 8600 'D' JERSEY CT. RALEIGH, NC 27617  
 919.480.1075

INFO@JDSDESIGNONLINE.COM  
 WWW.JDSDESIGNONLINE.COM

PROJECT NO.: 19901771  
 DATE: 8/26/2019

PLAN:  
**240.3174**

FIRST FLOOR  
 WALL BRACING PLAN

**S4.0C**

These designs and drawings are CONFIDENTIAL, and the enclosure property of KB Home Corporation and are not to be disclosed without the express permission of KB Home Corporation. They may not be used or duplicated without the express permission of KB Home Corporation. Copyright 2019 © KB Home Corporation, all rights reserved.

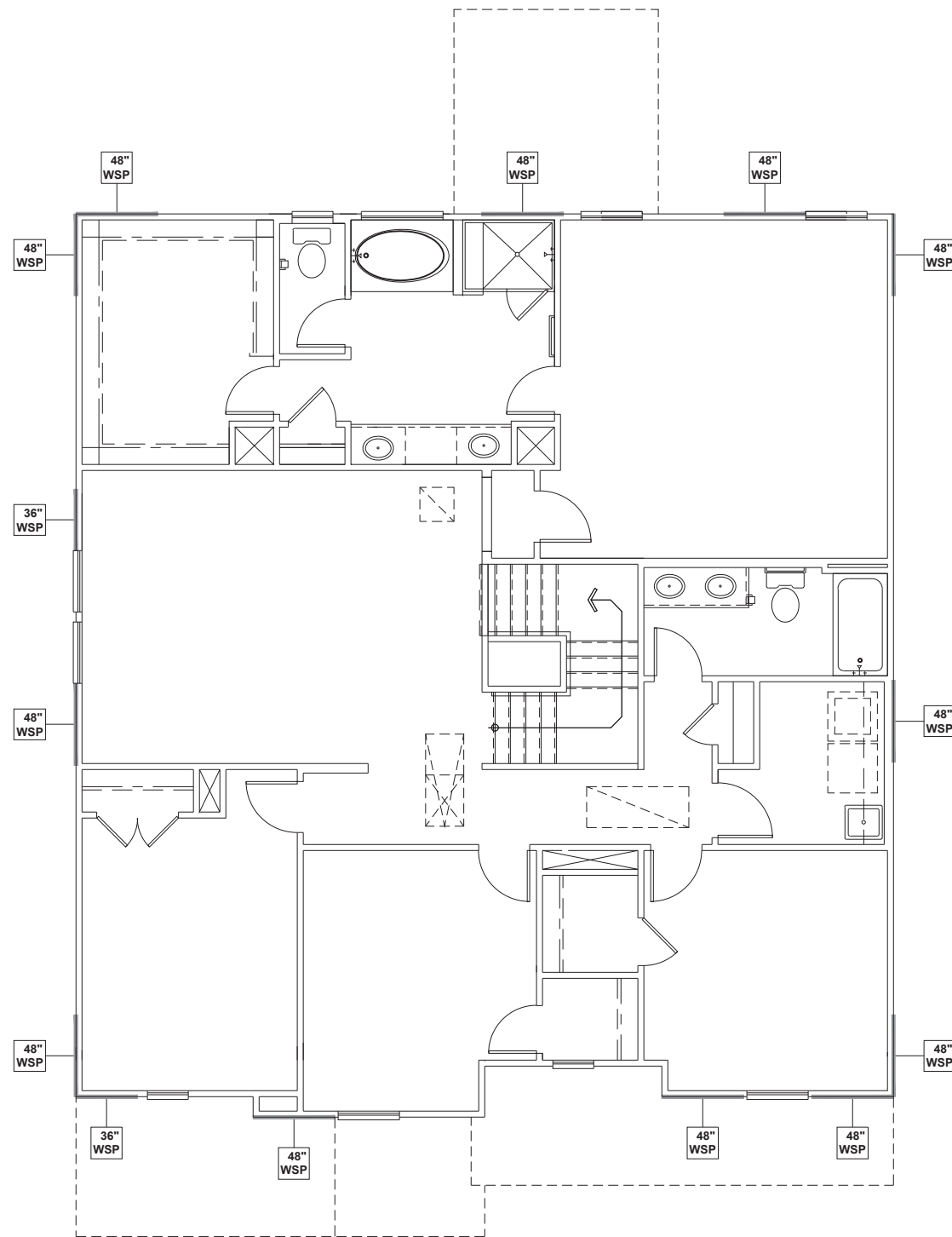

**WALL BRACING REQUIREMENTS**

- MINIMUM PANEL WIDTH IS 24"
- FIGURES BASED ON THE CONTINUOUS SHEATHING METHOD USING THE RECTANGLE CIRCUMSCRIBED AROUND THE FLOOR PLAN OR PORTION OF THE FLOOR PLAN. IF NO RECTANGLE IS NOTED, THE STRUCTURE HAS BEEN FIGURED ALL WITHIN ONE RECTANGLE.
- PANELS MAY SHIFT UP TO 36" EITHER DIRECTION FOR EASE OF CONSTRUCTION (NAILING & BLOCK REQUIREMENTS STILL APPLY).
- FOR ADDITIONAL WALL BRACING INFORMATION, REFER TO WALL BRACING DETAIL SHEET(S).
- SCHEMATIC BELOW INDICATES HOW SIDES OF RECTANGLE ARE TO BE INTERPRETED IN BRACING CHART WHEN APPLIED TO STRUCTURE:

- ◆ CS16 STRAP FROM STUD, CROSS HEADER, TO WALL TOP PLATE, 36" LONG MINIMUM
- ▶ SIMPSON MSTA15 HOLD DOWN CAPACITY OF 970 POUNDS PER ANCHOR WITH (12) 10d NAILS. STRAP TO BE LOCATED AT EDGE OF BRACED WALL PANEL. (CS16 STRAPPING MAY BE SUBSTITUTED w/ SIMILAR LENGTH AND NAILING PATTERN.) USE HTT4 FOR ATTACHMENT TO CONCRETE.

SCALED LENGTH OF WALL PANEL AT LOCATION

NUMERICAL LENGTH OF PANEL  
 PANEL TYPE

**WALL BRACING NOTE:**

WALLS WITH REQUIRED LENGTH LISTED AS "N/A" DO NOT MEET THE REQUIREMENTS OF PRESCRIPTIVE WALL BRACING FOUND IN THE NCRC. THESE WALLS HAVE BEEN ENGINEERED BASED ON DESIGN GUIDELINES ESTABLISHED IN ASCE-07 AND THE NDS: WIND & SEISMIC PROVISIONS SUPPLEMENT.

**WALL BRACING: RECTANGLE 1**

SIDE	REQUIRED LENGTH	PROVIDED LENGTH
FRONT	9.0 FT.	15.0 FT.
LEFT	9.0 FT.	15.0 FT.
REAR	9.0 FT.	12.0 FT.
RIGHT	9.0 FT.	12.0 FT.

**SECOND FLOOR WALL BRACING PLAN - 'C'**  
SCALE: 1/8" = 1'-0"



KB HOME  
NORTH CAROLINA DIVISION  
4518 S. MIAMI BLVD.  
SUITE 180  
DURHAM, NC 27703  
TEL: (919) 768-7988  
FAX: (919) 472-0582



P-0961

**JDS**  
CONSULTING & DESIGN

JDS CONSULTING & DESIGN, PLLC  
8600 'D' JERSEY CT, RALEIGH, NC 27617  
919.480.1075

INFO@JDSDESIGNONLINE.COM  
WWW.JDSDESIGNONLINE.COM

PROJECT NO.: 19901771  
DATE: 8/26/2019

PLAN:  
**240.3174**

SECOND FLOOR  
WALL BRACING PLAN  
**S5.0C**

These designs and drawings are CONFIDENTIAL, and the enclosure property of KB Home Corporation, and are not to be disclosed without the express permission of KB Home Corporation. They may not be used or duplicated without the express permission of KB Home Corporation. Copyright 2019 © KB Home Corporation, all rights reserved.

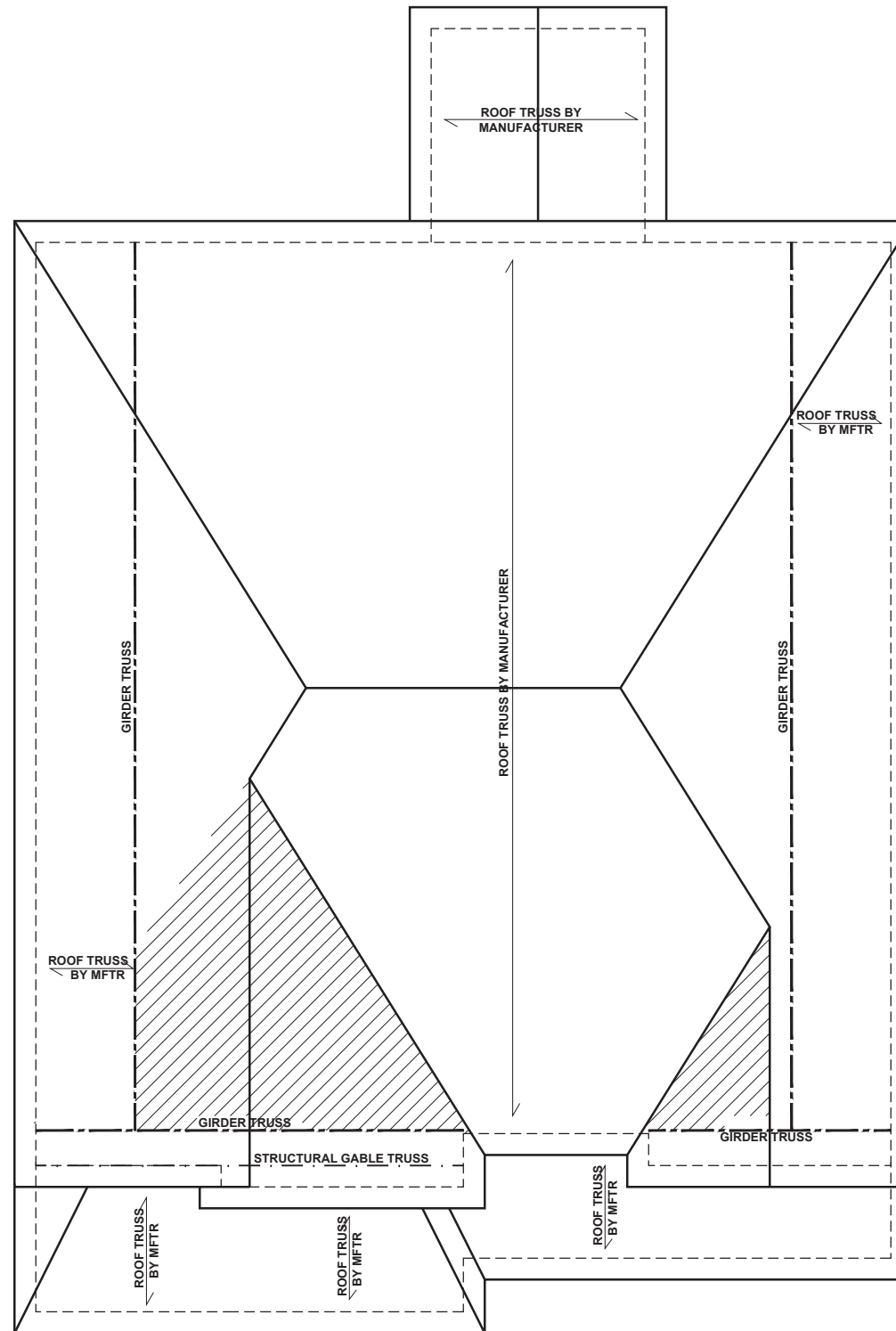

**ROOF FRAMING PLAN - 'C'**  
SCALE: 1/8" = 1'-0"

**BEAM & POINT LOAD LEGEND**

	INTERIOR LOAD BEARING WALL
	ROOF RAFTER / TRUSS SUPPORT
	DOUBLE RAFTER / DOUBLE JOIST
	STRUCTURAL BEAM / GIRDER
	WINDOW / DOOR HEADER
	POINT LOAD TRANSFER
	POINT LOAD FROM ABOVE BEARING ON BEAM / GIRDER

- TRUSSED ROOF - STRUCTURAL NOTES**
- PROVIDE CONTINUOUS BLOCKING THROUGH STRUCTURE FOR ALL POINT LOADS.
  - DENOTES OVER-FRAMED AREA
  - MINIMUM 7/16" OSB ROOF SHEATHING
  - TRUSS LAYOUT AND PLACEMENT BY MANUFACTURER TO COINCIDE WITH THE SUPPORT LOCATIONS SHOWN. TRUSS PROFILES SHALL BE SEALED BY THE TRUSS MANUFACTURER. TRUSS PLANS TO BE COORDINATED WITH THE SEALED STRUCTURAL DRAWINGS. INSTALLATION SHALL BE IN ACCORDANCE WITH THE MANUFACTURER'S INSTRUCTIONS.
  - MANUFACTURER TO PROVIDE REQUIRED UPLIFT CONNECTION.
  - PROVIDE H2.5A (MINIMUM) OR EQUIVALENT AT EACH TRUSS-TO-TOP PLATE CONNECTION AT OVER-FRAMED AREAS, UNLESS NOTED OTHERWISE.
  - UPLIFT CONNECTION TO BE CARRIED THROUGH TO FLOOR SYSTEM.

**TRUSS UPLIFT CONNECTORS: EXPOSURE B, 115 MPH, ANY PITCH, 24" O.C. MAX ROOF TRUSS SPACING**

TRUSSES SHALL BE ATTACHED TO SUPPORT WALL FOR UPLIFT RESISTANCE. CONTINUOUS OSB WALL SHEATHING BELOW PROVIDES CONTINUOUS UPLIFT RESISTANCE TO FOUNDATION. ALL TRUSSES SUPPORTED BY INTERMEDIATE SUPPORT WALLS, KNEEWALLS, OR BEAMS SHALL BE ATTACHED TO SUPPORTING MEMBER PER SCHEDULE:

ROOF PLAN UP TO 28'	CONNECTOR NAILING PER TABLE 602.3(1) NCRBC 2018 EDITION
OVER 28'	(1) SIMPSON H2.5A HURRICANE CLIP TO DBL TOP PLATE OR BEAM OR (1) SIMPSON H3 CLIP TO SINGLE 2x4 PLATE



KB HOME  
NORTH CAROLINA DIVISION  
4518 S. MIAMI BLVD.  
SUITE 180  
DURHAM, NC 27703  
TEL: (919) 768-7988  
FAX: (919) 472-0582



P-0961

**JDS**  
CONSULTING & DESIGN

JDS CONSULTING & DESIGN, PLLC  
8600 'D' JERSEY CT, RALEIGH, NC 27617  
919.480.1075

INFO@JDSDESIGNONLINE.COM  
WWW.JDSDESIGNONLINE.COM

PROJECT NO.: 19901771  
DATE: 8/26/2019

PLAN:  
**240.3174**

ROOF FRAMING PLAN  
**S7.0C**

These designs and drawings are CONFIDENTIAL, and the enclosure property of KB Home Corporation and are not to be disclosed without the express permission of KB Home Corporation. They may not be used or duplicated without the express permission of KB Home Corporation. Copyright 2019 © KB Home Corporation, all rights reserved.



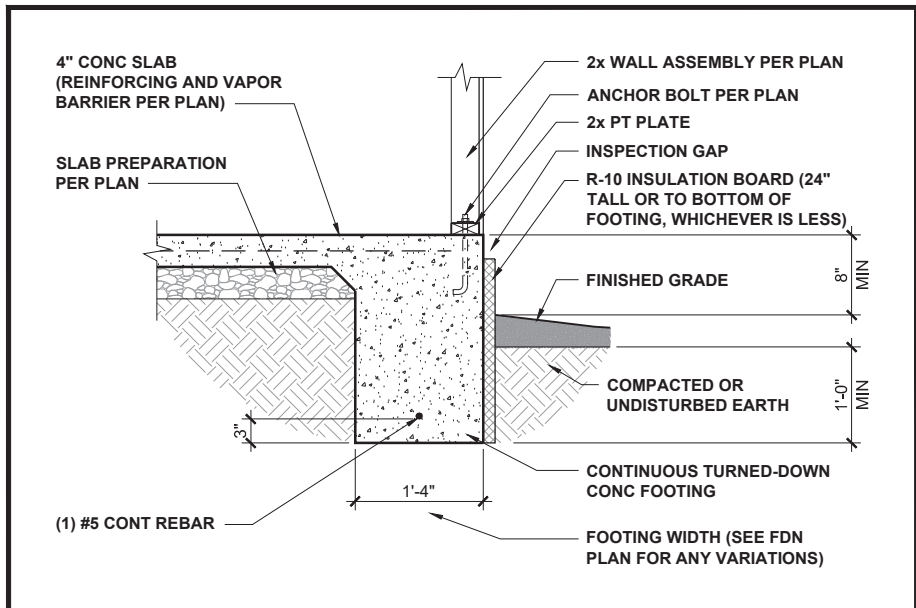

**TURNED-DOWN CONC SLAB FOOTING** 1/2" = 1'-0" **1**

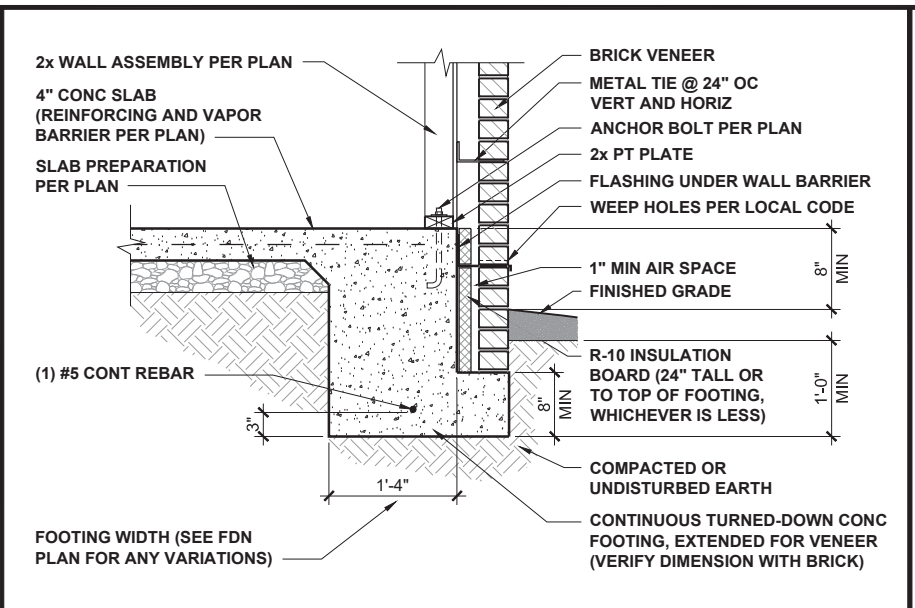

**TURNED-DOWN FOOTING w/ BRICK** 1/2" = 1'-0" **2**

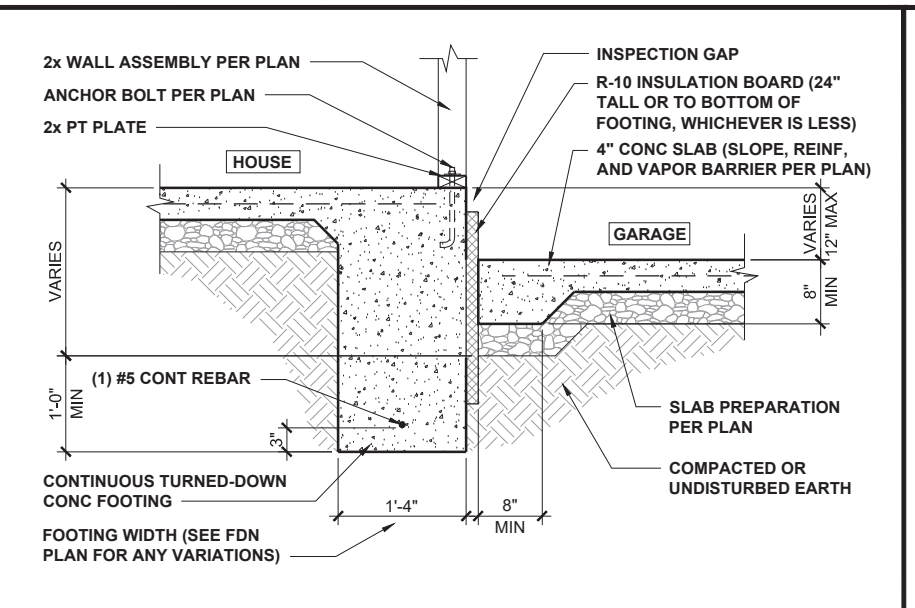

**HOUSE / GARAGE FOOTING** 1/2" = 1'-0" **3**

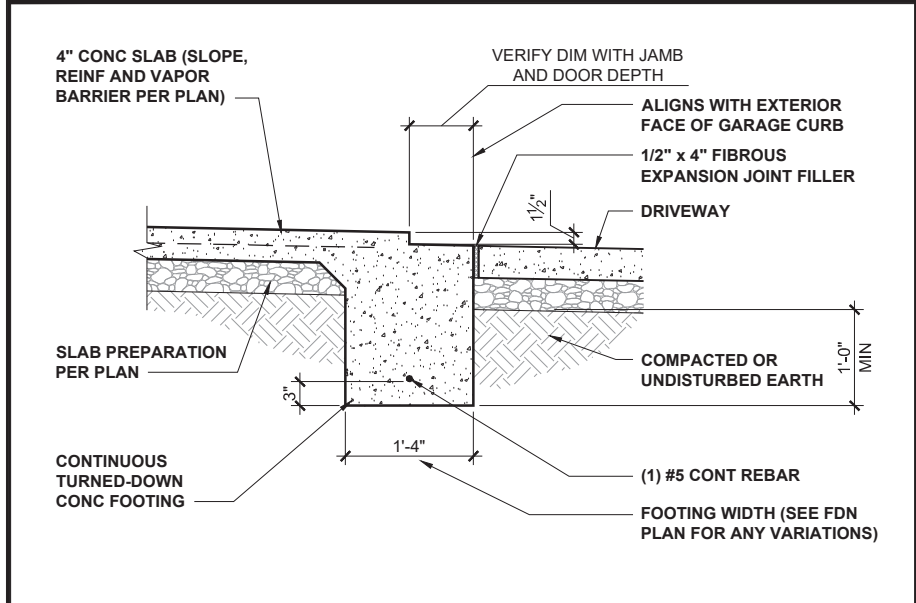

**GARAGE DOORWAY FOOTING** 1/2" = 1'-0" **4**

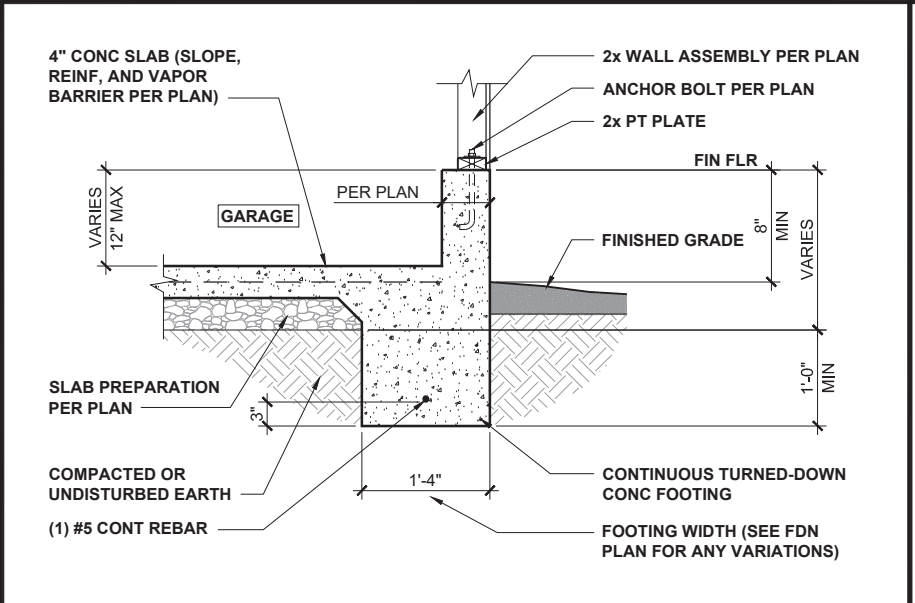

**GARAGE FOUNDATION** 1/2" = 1'-0" **5**

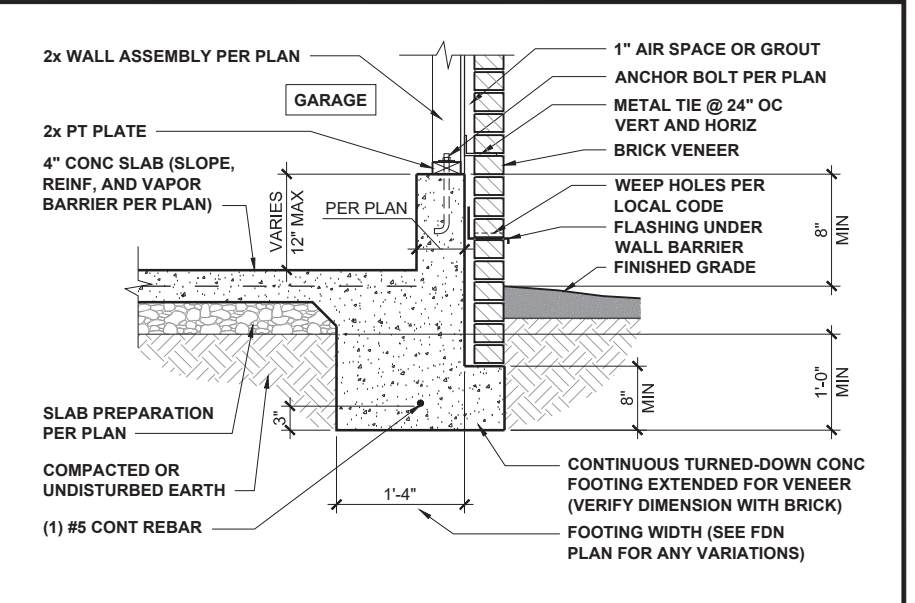

**GARAGE FOUNDATION WITH BRICK** 1/2" = 1'-0" **6**

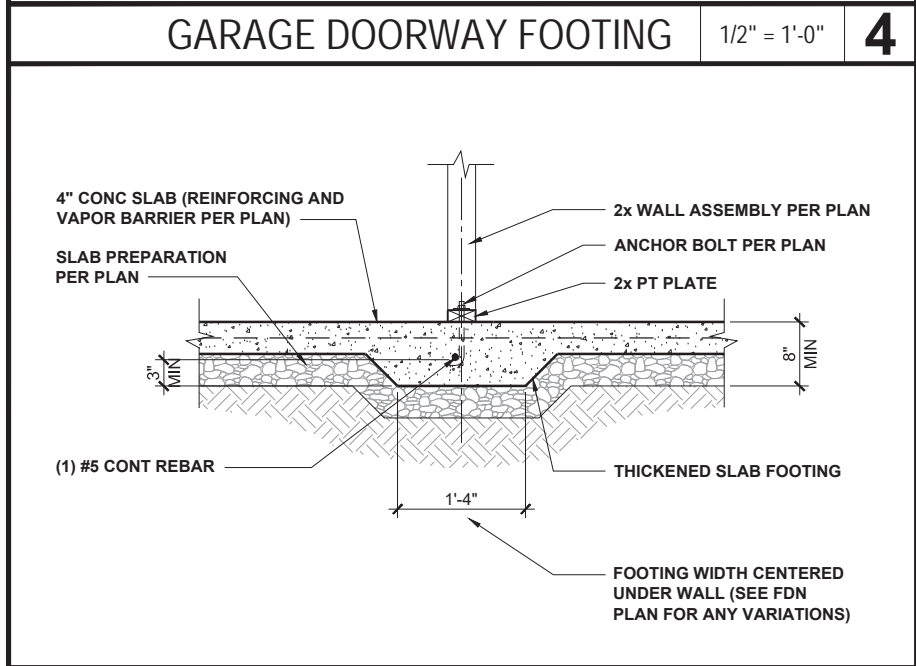

**INTERIOR FOOTING** 1/2" = 1'-0" **7**

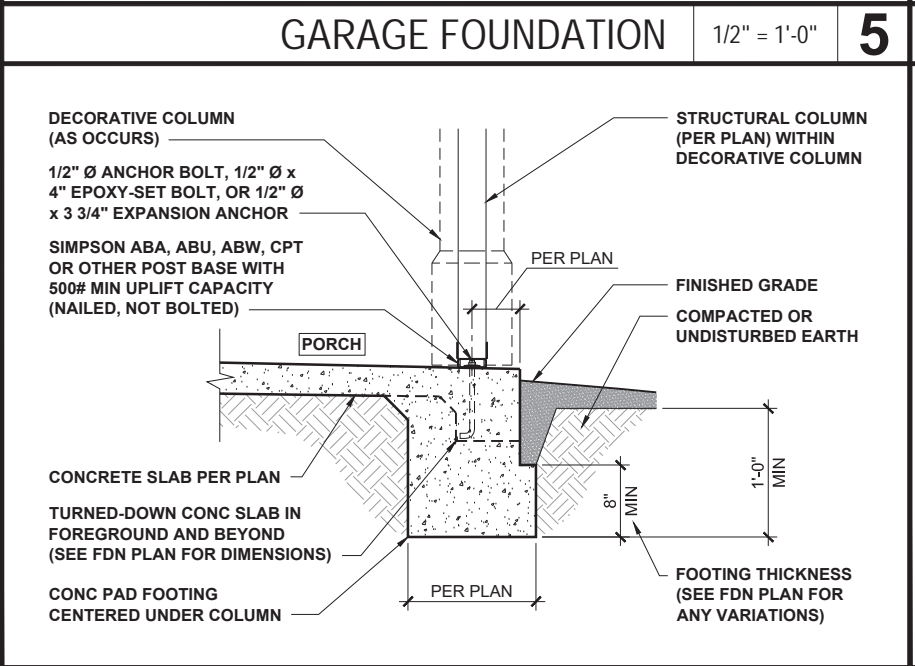

**PORCH COLUMN FOUNDATION** 1/2" = 1'-0" **8**

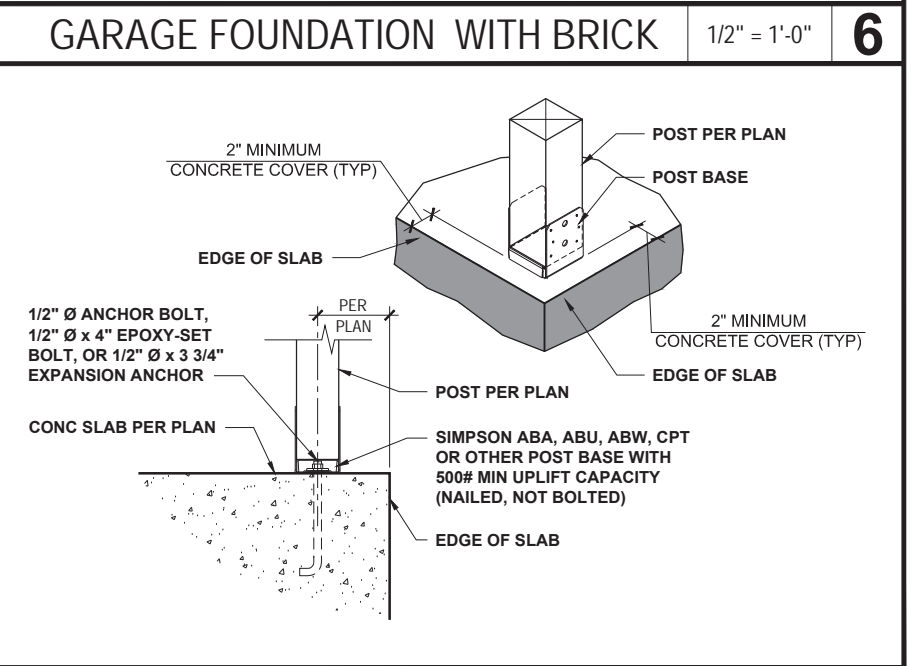

**PORCH COLUMN** 3/4" = 1'-0" **9**



KB HOME  
NORTH CAROLINA DIVISION  
4518 S. MIAMI BLVD.  
SUITE 180  
DURHAM, NC 27703  
TEL: (919) 768-7988  
FAX: (919) 472-0582

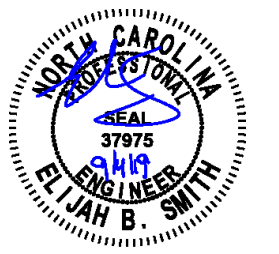

P-0961  
**JDS**  
CONSULTING & DESIGN  
JDS CONSULTING & DESIGN, PLLC  
8600 'D' JERSEY CT. RALEIGH, NC 27617  
919.480.1075  
INFO@JDSDESIGNONLINE.COM  
WWW.JDSDESIGNONLINE.COM

PROJECT NO.: 19901771  
DATE: 8/26/2019

PLAN:  
**240.3174**

TURNED-DOWN SLAB  
FOUNDATION DETAILS

**D1.0**

These designs and drawings are CONFIDENTIAL and the exclusive property of KB Home Corporation and are not to be disclosed without the express permission of KB Home Corporation. Copyright 2019 © KB Home Corporation. All rights reserved.

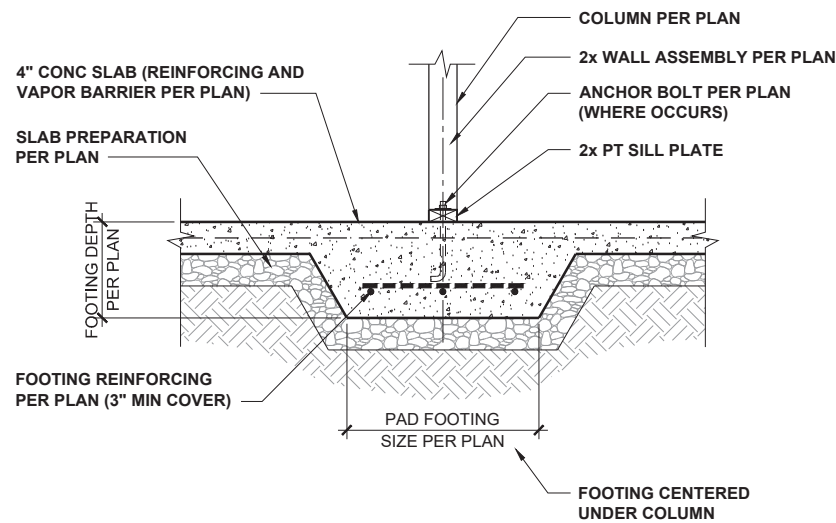

INT POINT-LOAD FOOTING SECTION 1/2" = 1'-0" **1**

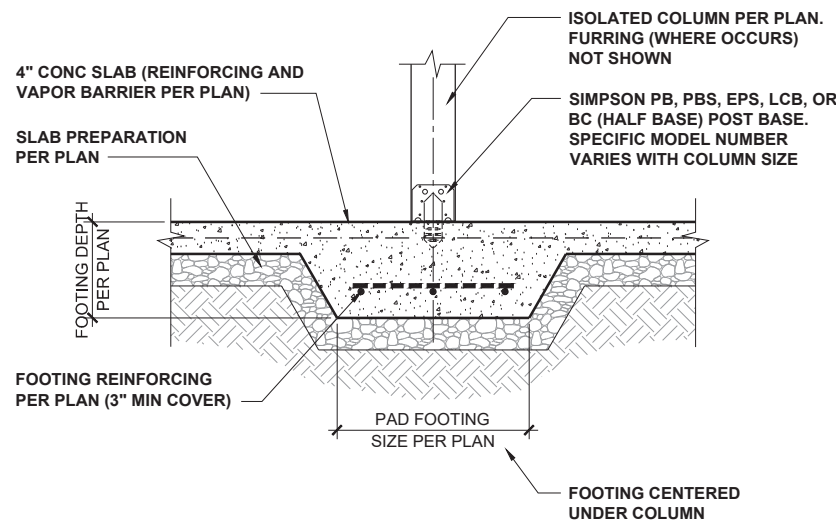

ISOLATED COLUMN FOOTING 1/2" = 1'-0" **2**

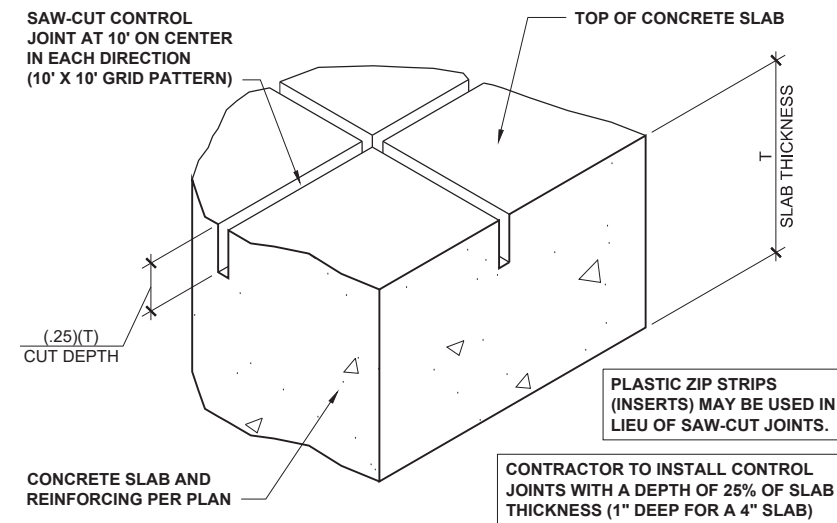

CONCRETE SLAB CONTROL JOINTS 3" = 1'-0" **3**

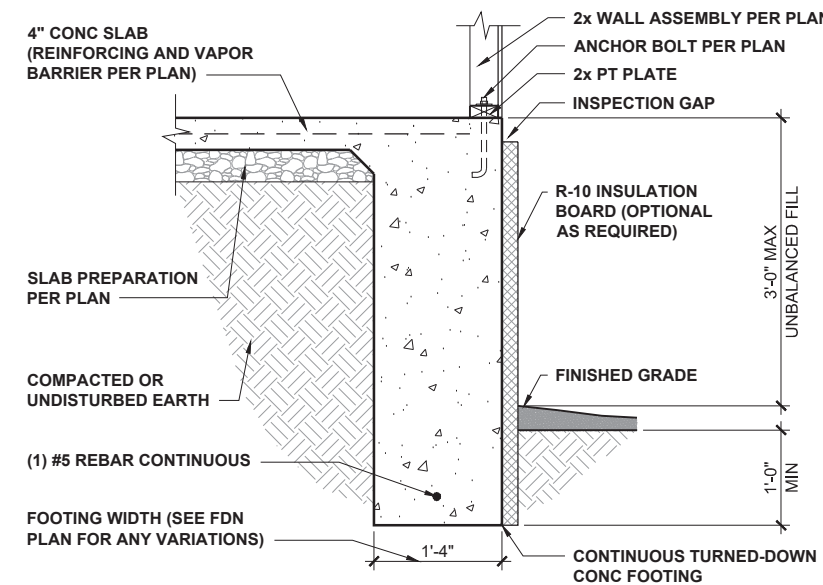

3' EXTENDED TURNED DOWN FOOTING 1/2" = 1'-0" **4**

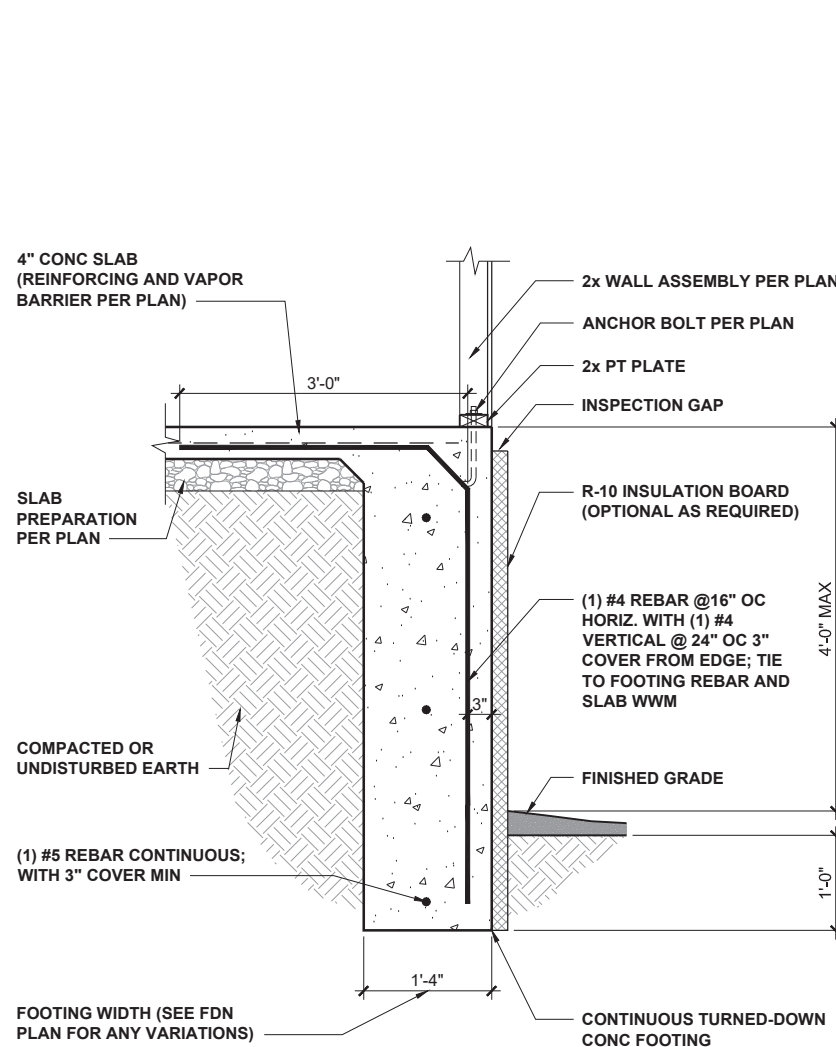

4' EXTENDED RETAINED FOOTING 1/2" = 1'-0" **6**

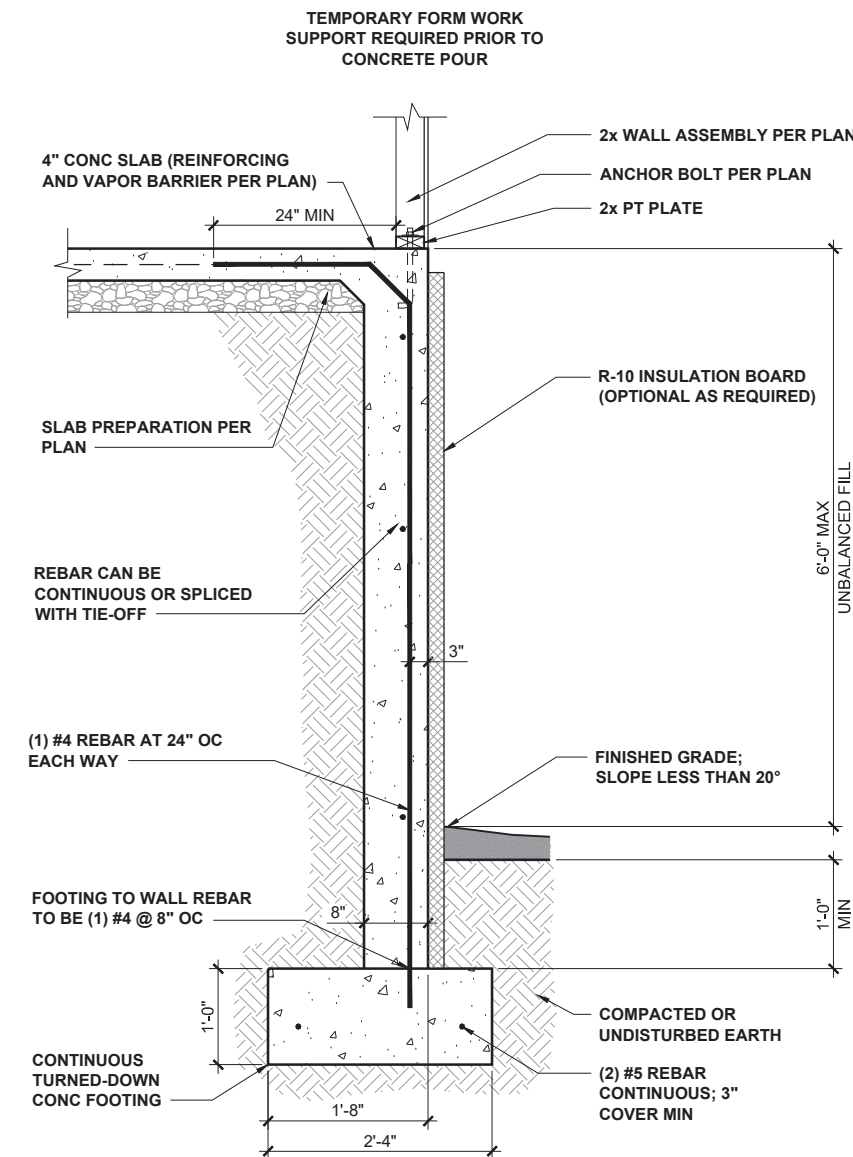

6' EXTENDED REINFORCED FOOTING 1/2" = 1'-0" **7**

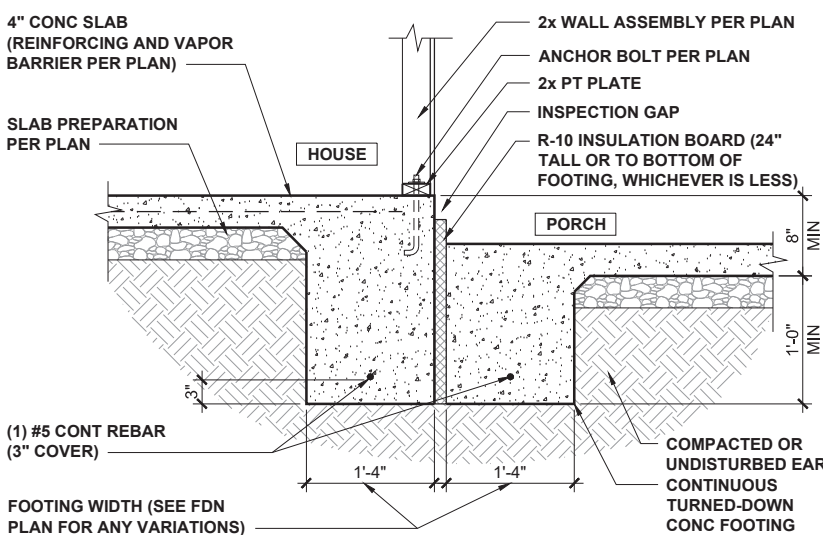

FOOTING AT HOUSE/PORCH 1/2" = 1'-0" **5**



KB HOME  
NORTH CAROLINA DIVISION  
4518 S. MIAMI BLVD.  
SUITE 180  
DURHAM, NC 27703  
TEL: (919) 768-7988  
FAX: (919) 472-0582

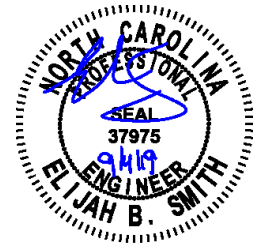

P-0961



JDS CONSULTING & DESIGN, PLLC  
8600 'D' JERSEY CT, RALEIGH, NC 27617  
919.480.1075

INFO@JDSDESIGNONLINE.COM  
WWW.JDSDESIGNONLINE.COM

PROJECT NO.: 19901771  
DATE: 8/26/2019

PLAN:  
240.3174

TURNED-DOWN SLAB  
FOUNDATION DETAILS

**D2.0**

These designs and drawings are CONFIDENTIAL, and the contents are the property of KB Home Corporation and are not to be disclosed without the express permission of KB Home Corporation. They may not be used or duplicated without the express permission of KB Home Corporation. Copyright 2019 © KB Home Corporation. All rights reserved.

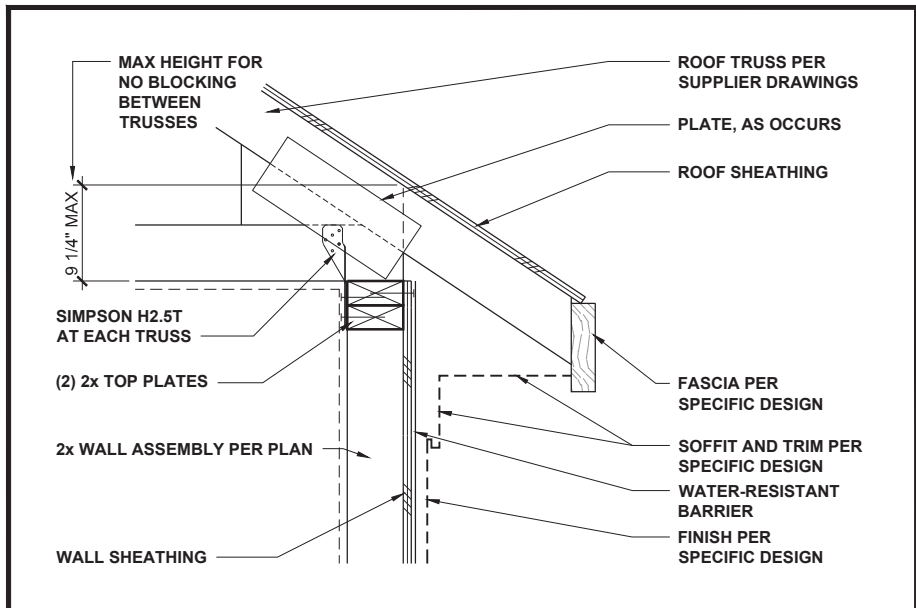

LOW-HEEL TRUSS AT WALL 1" = 1'-0" **1**

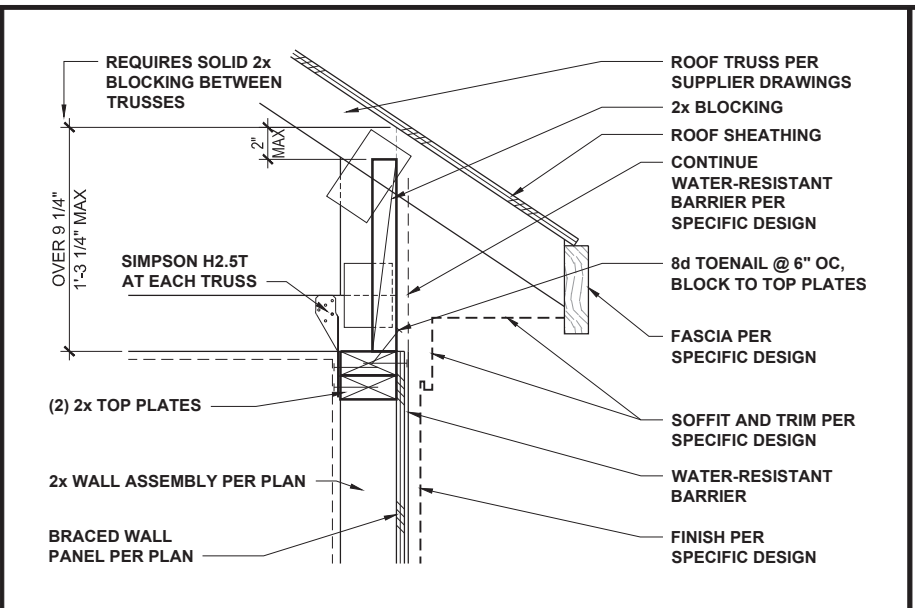

TYPICAL TRUSS AT BRACED WALL 1" = 1'-0" **2**

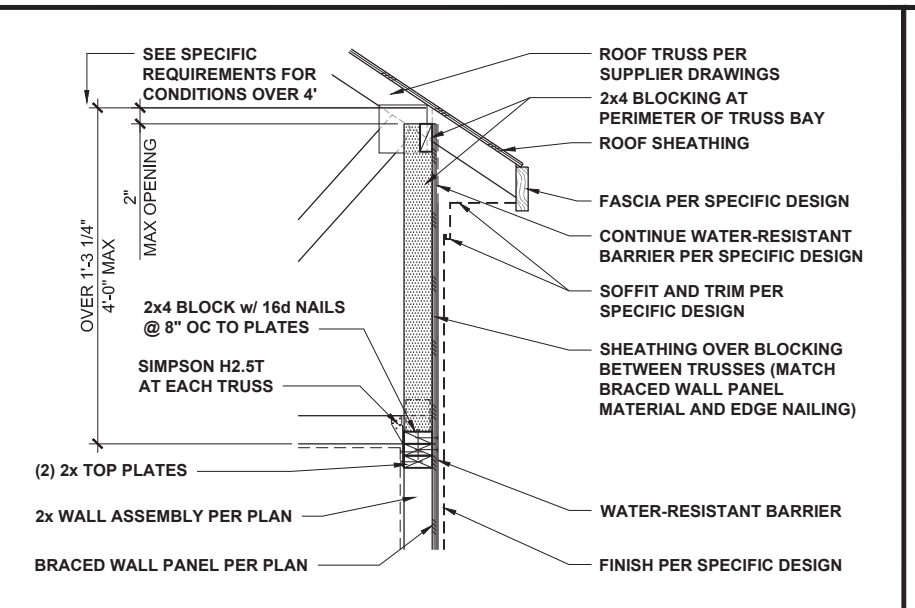

HIGH-HEEL TRUSS AT BRACED WALL 1/2" = 1'-0" **3**

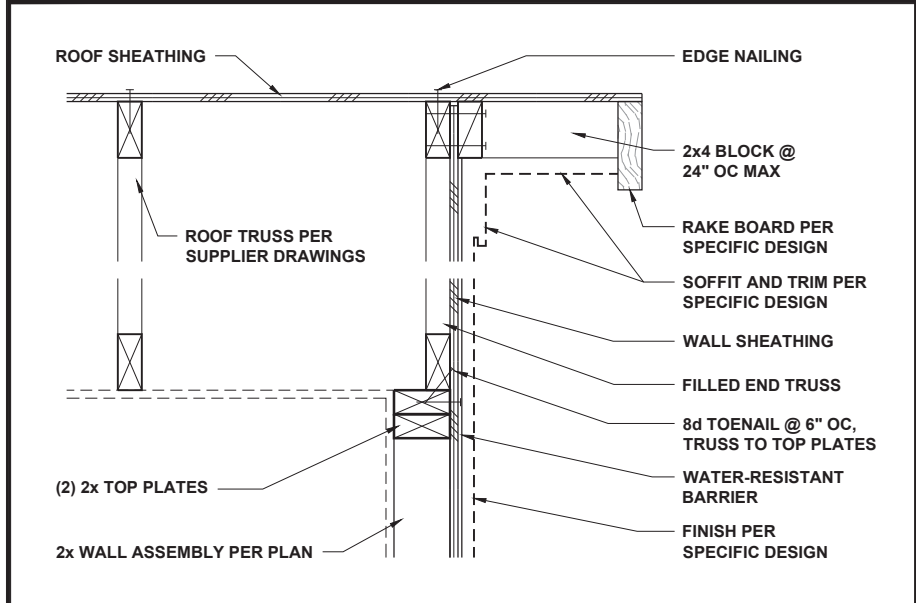

END TRUSS AT WALL 1" = 1'-0" **4**

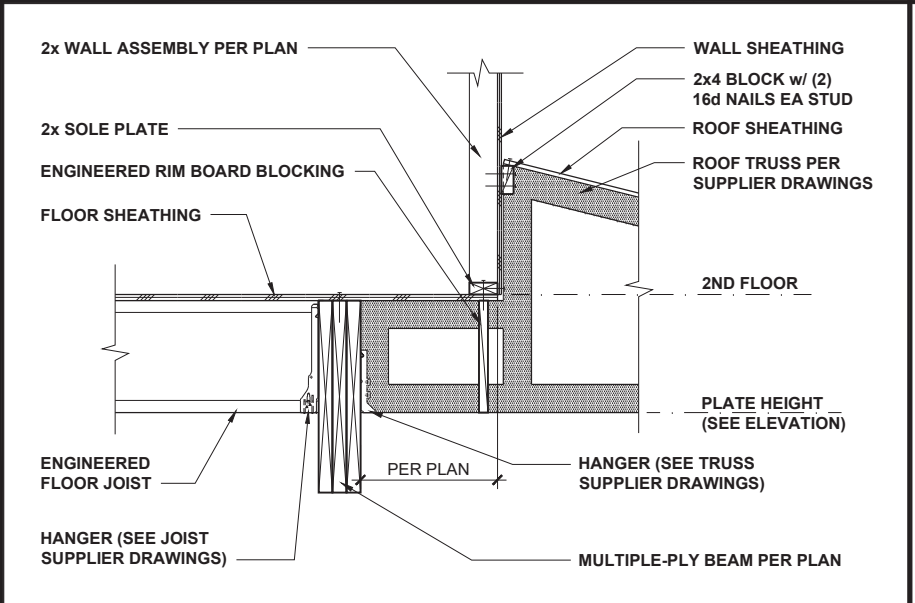

TRUSS AT BEAM AND WALL 1/2" = 1'-0" **5**

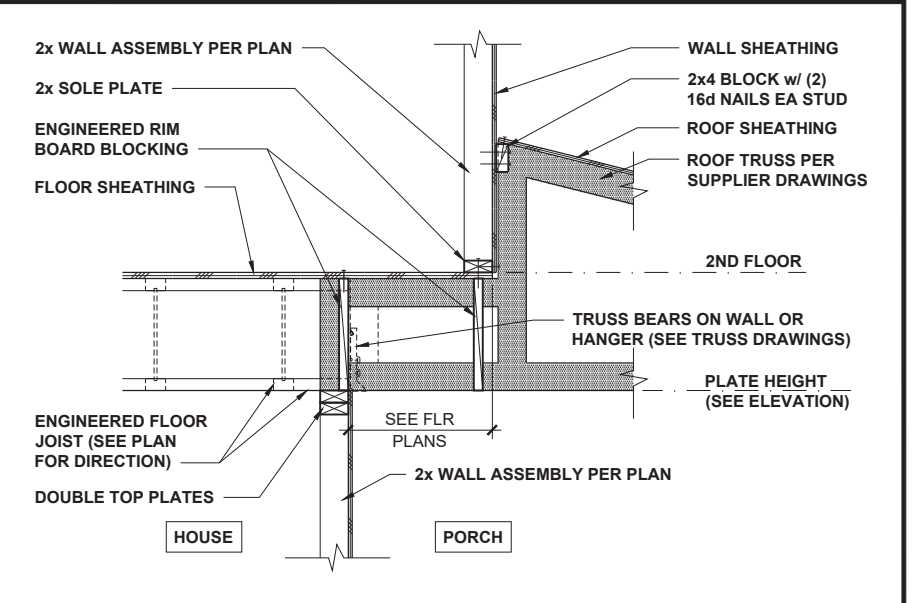

TRUSS AT FLOOR AND WALL 1/2" = 1'-0" **6**

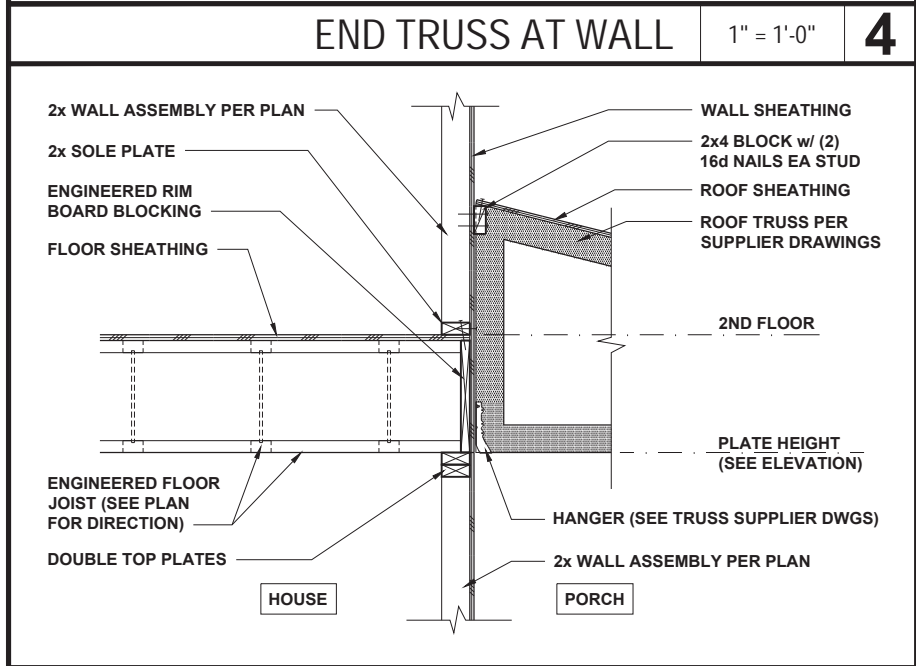

TRUSS AT FLOOR AND WALL 1/2" = 1'-0" **7**

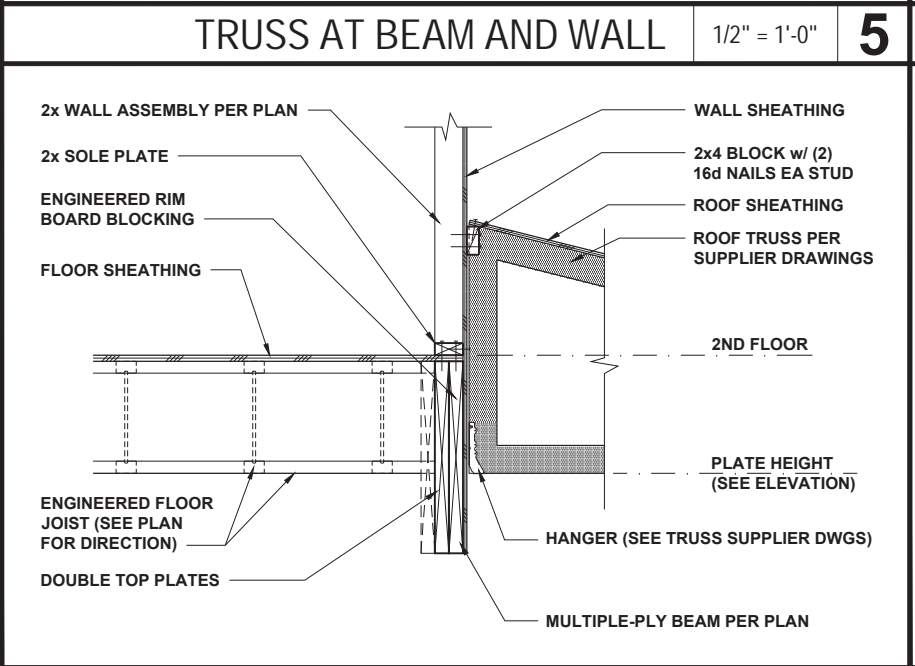

TRUSS AT BEAM AND WALL 1/2" = 1'-0" **8**

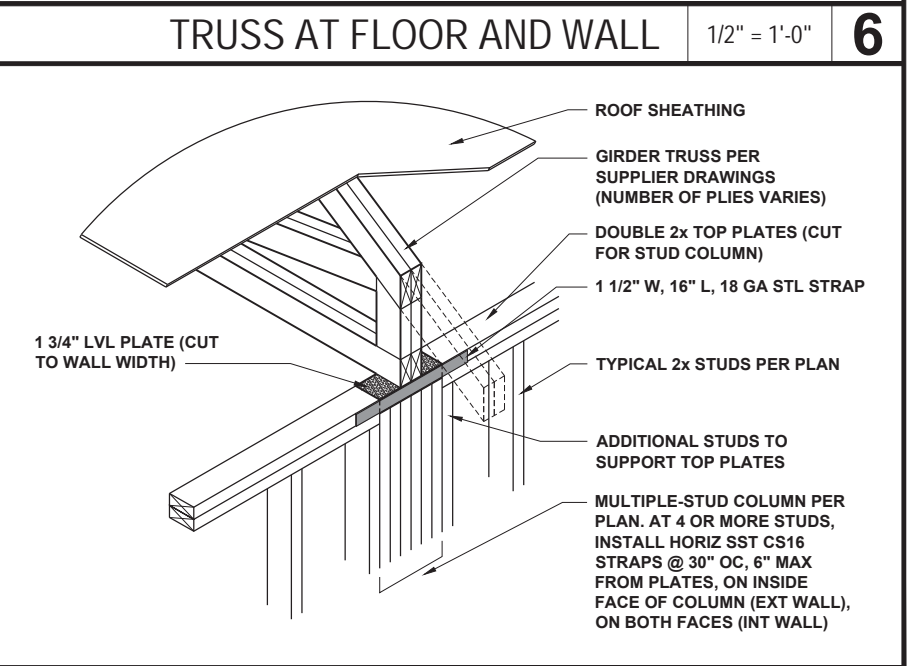

GIRDER TRUSS AT WALL 1/2" = 1'-0" **9**



KB HOME  
NORTH CAROLINA DIVISION  
4518 S. MIAMI BLVD.  
SUITE 180  
DURHAM, NC 27703  
TEL: (919) 768-7988  
FAX: (919) 472-0582

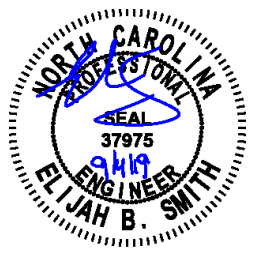

P-0961



PROJECT NO.: 19901771  
DATE: 8/26/2019

PLAN:  
**240.3174**

ROOF TRUSS  
FRAMING DETAILS

**D4.0**

These designs and drawings are CONFIDENTIAL and the exclusive property of KB Home Corporation and are not to be disclosed without the express permission of KB Home Corporation. Copyright 2019 © KB Home Corporation. All rights reserved.

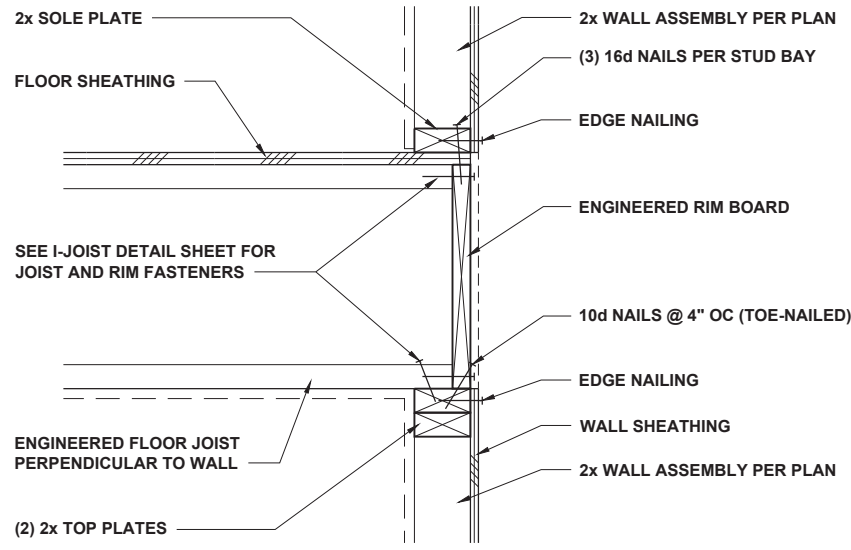

FLOOR JOISTS PERP TO WALL 1" = 1'-0" **1**

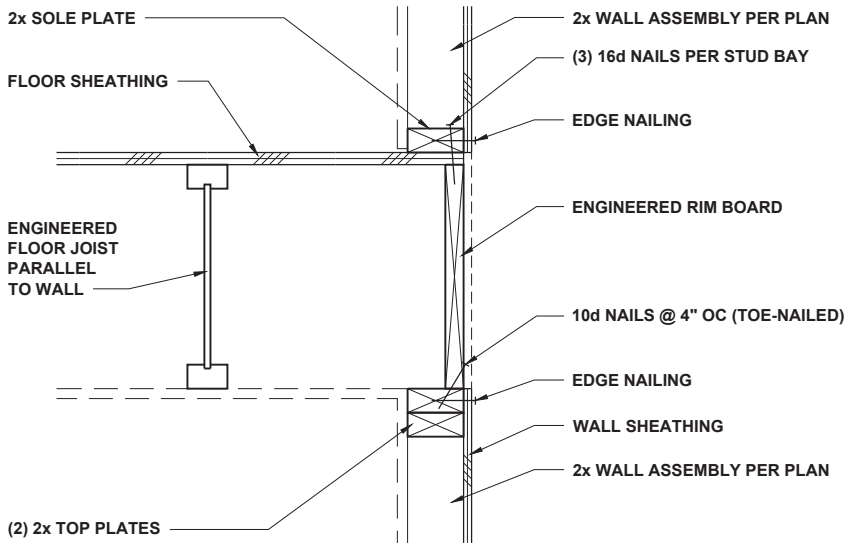

FLOOR JOISTS PARALLEL TO WALL 1" = 1'-0" **2**

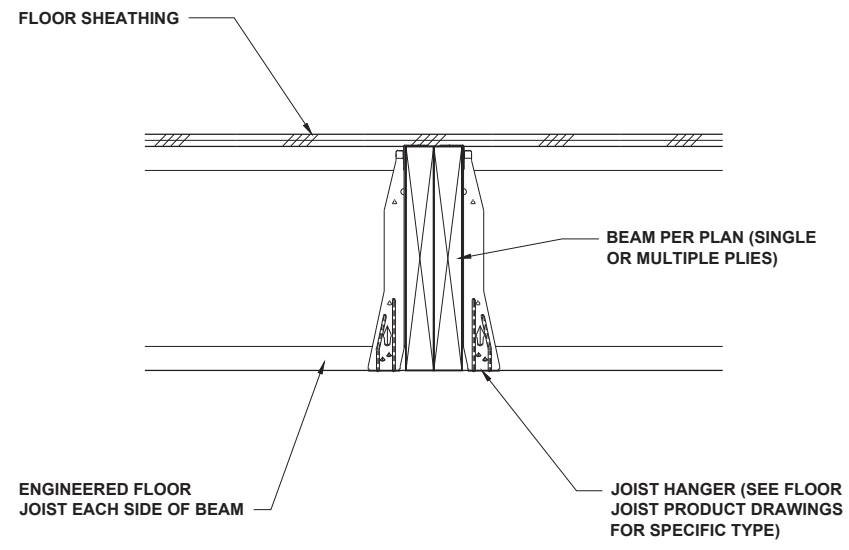

FLOOR JOISTS AT FLUSH BEAM 3/4" = 1'-0" **3**

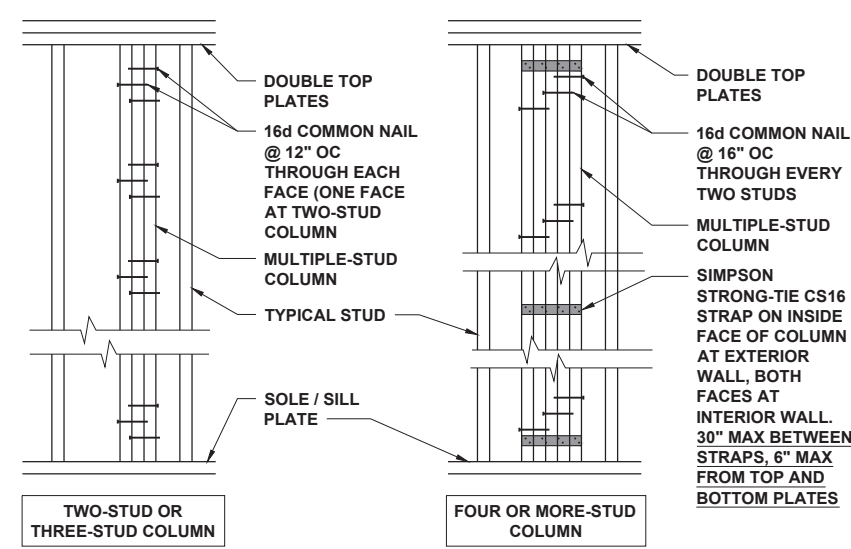

MULTIPLE-STUD COLUMN FASTENING 1/2" = 1'-0" **4**

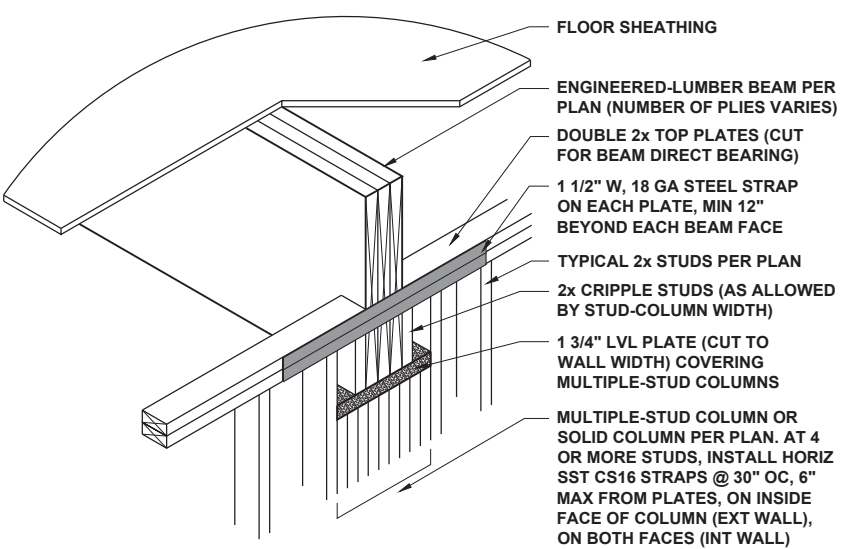

BEAM INTO WALL 1/2" = 1'-0" **5**

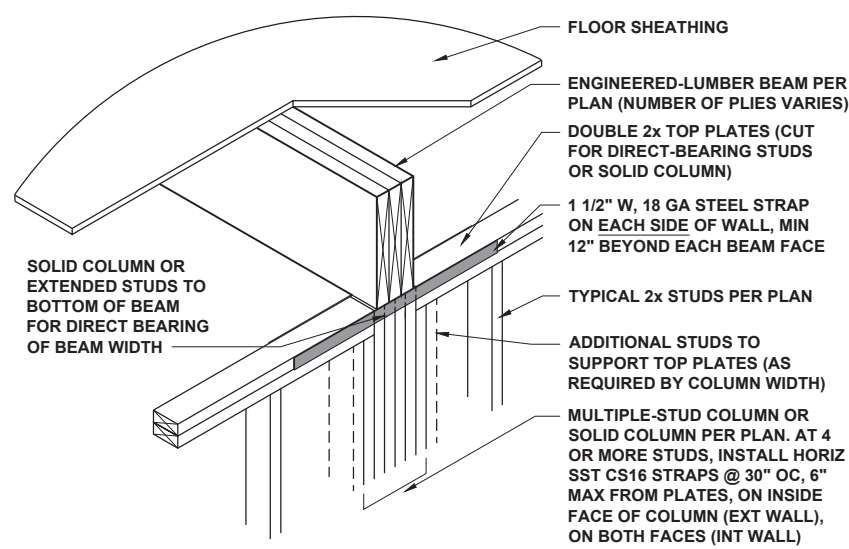

FLUSH BEAM AT WALL 1/2" = 1'-0" **6**

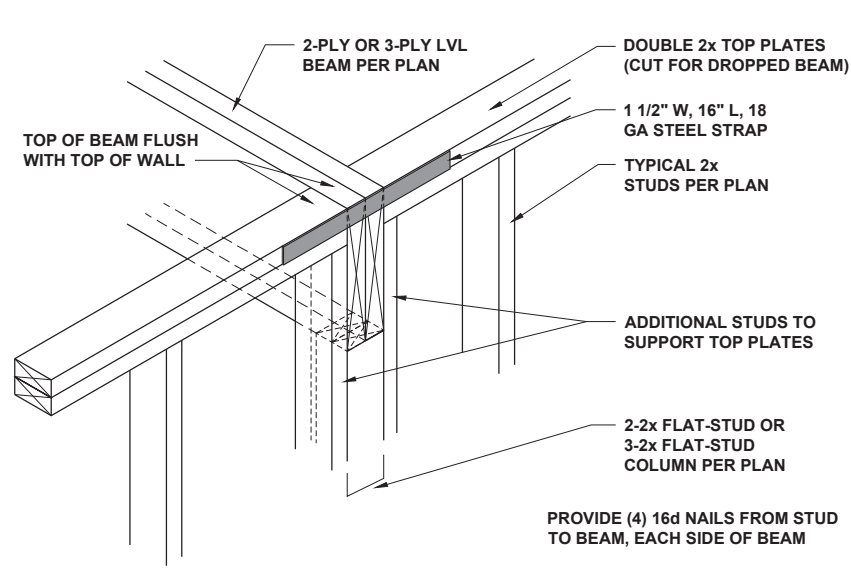

DROPPED LVL BEAM AT WALL 3/4" = 1'-0" **7**

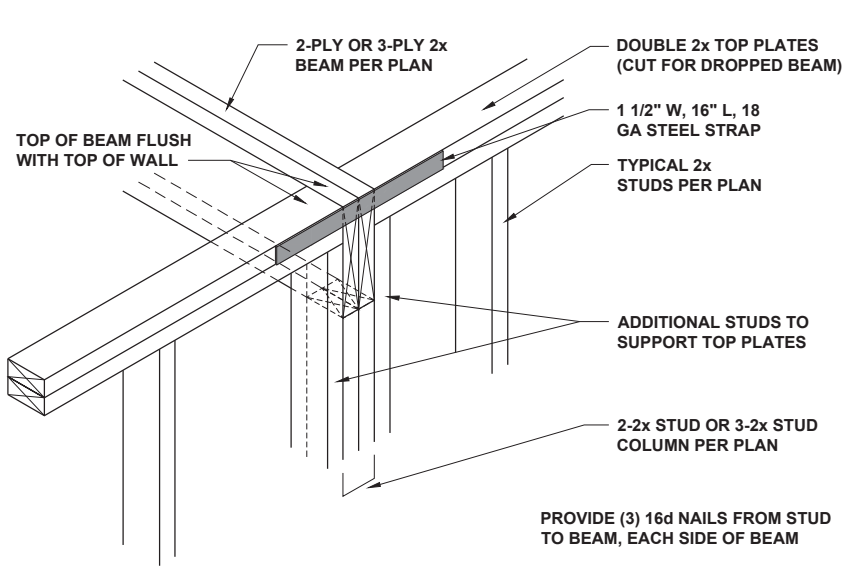

DROPPED 2x BEAM AT WALL 3/4" = 1'-0" **8**

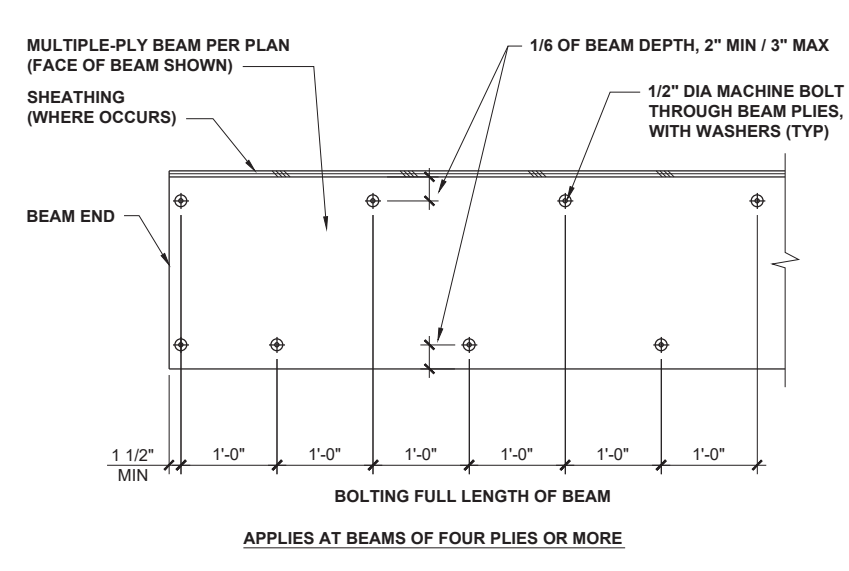

MULTIPLE-PLY BEAM BOLTING 1/2" = 1'-0" **9**



KB HOME  
NORTH CAROLINA DIVISION  
4518 S. MIAMI BLVD.  
SUITE 180  
DURHAM, NC 27703  
TEL: (919) 768-7988  
FAX: (919) 472-0582



P-0961



PROJECT NO.: 19901771  
DATE: 8/26/2019

PLAN:  
**240.3174**

MISCELLANEOUS  
FRAMING DETAILS

**D5.0**

These designs and drawings are CONFIDENTIAL, and the enclosure property of KB Home Corporation and are not to be disclosed without the express permission of KB Home Corporation. Copyright 2019 © KB Home Corporation. All rights reserved.

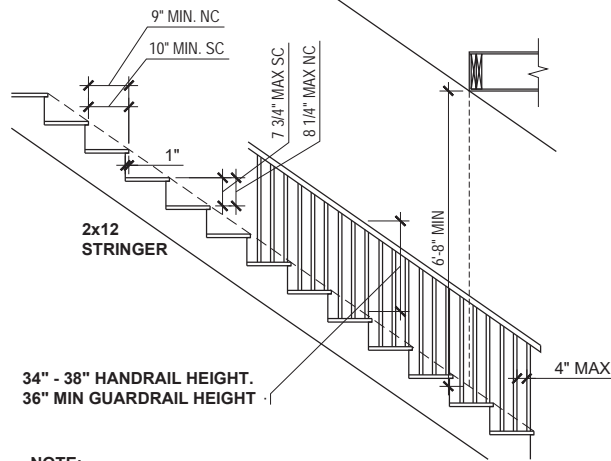

NOTE:  
EACH TREAD AND RISER MUST BE UNIFORM,  
WITH NO MORE THAN 3/8\"/>

TYPICAL STAIR REQUIREMENTS

1/4" = 1'-0"

1

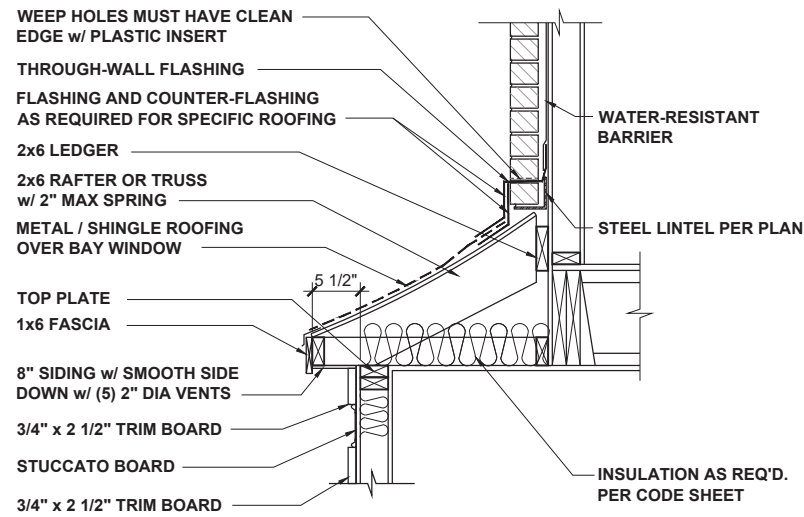

BAY ROOF

1/2" = 1'-0"

2

ALTERNATE LINTEL AT WIDE OPENING

1 1/2" = 1'-0"

3

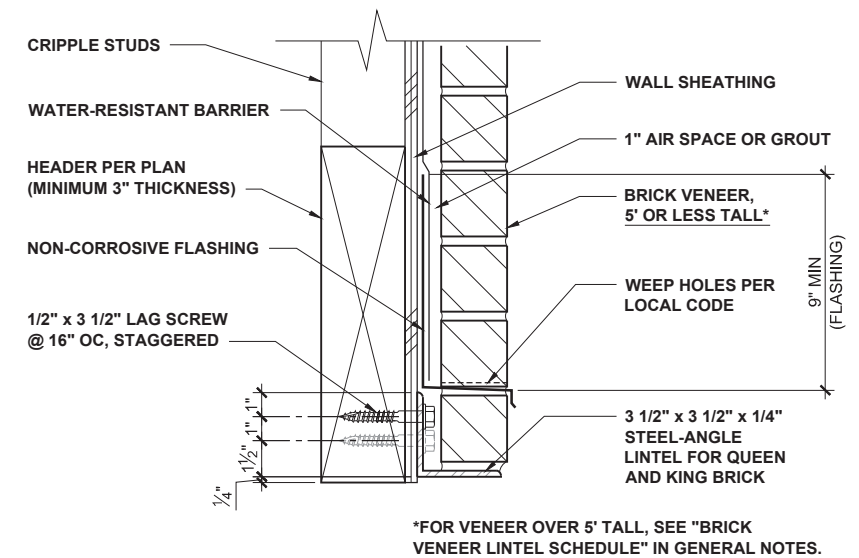

\*FOR VENEER OVER 5' TALL, SEE "BRICK VENEER LINTEL SCHEDULE" IN GENERAL NOTES.

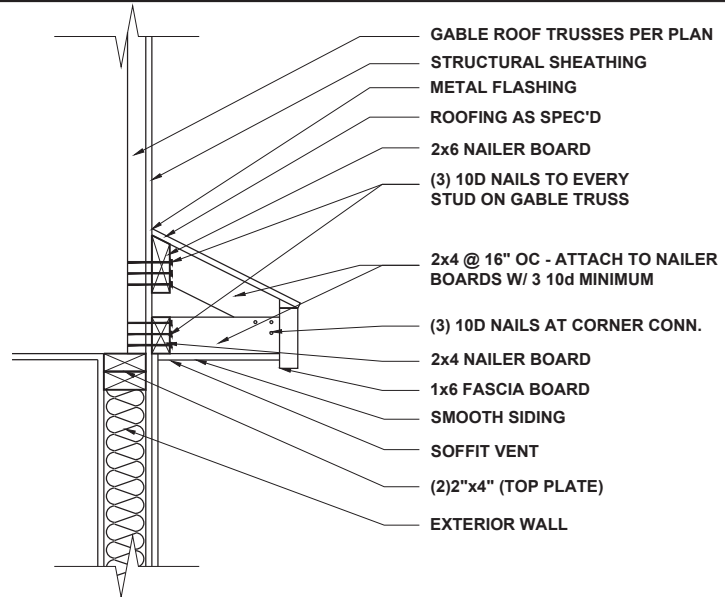

GABLE ROOF RETURN

3/4" = 1'-0"

4

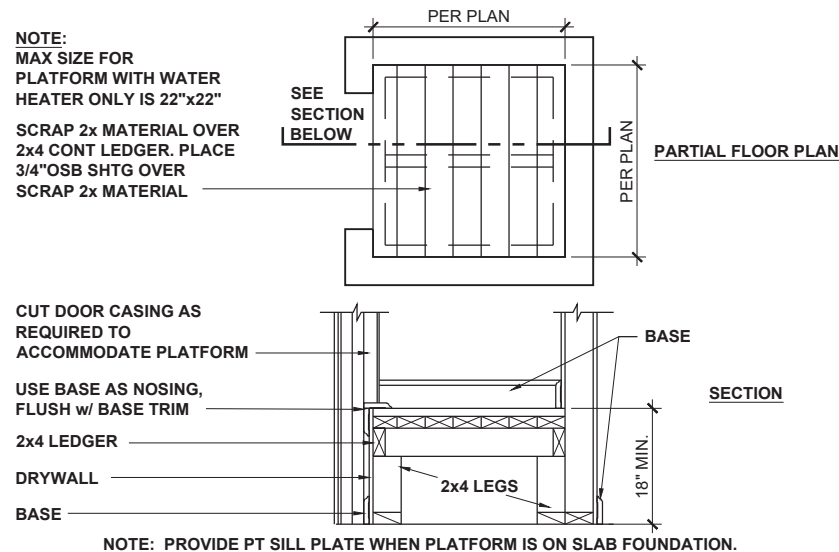

NOTE: PROVIDE PT SILL PLATE WHEN PLATFORM IS ON SLAB FOUNDATION.

HVAC / WATER HEATER CLOSET

1/2" = 1'-0"

5

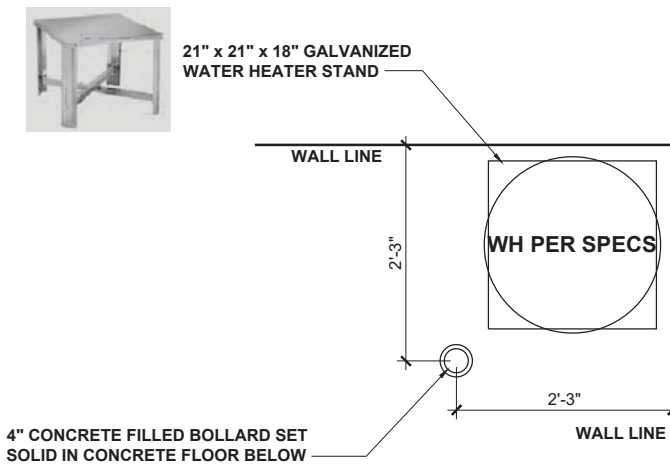

WATER HTR PLATFORM IN GARAGE

1/2" = 1'-0"

6

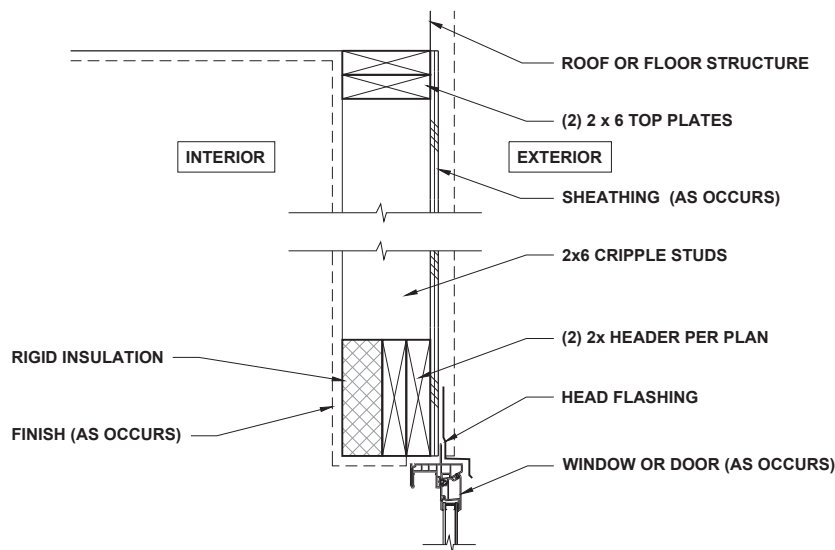

HEADER WITH INSULATION

1" = 1'-0"

7



KB HOME  
NORTH CAROLINA DIVISION  
4518 S. MIAMI BLVD.  
SUITE 180  
DURHAM, NC 27703  
TEL: (919) 768-7988  
FAX: (919) 472-0582

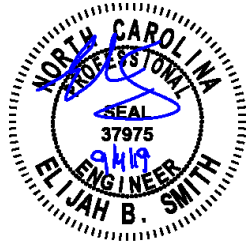

P-0961



JDS CONSULTING & DESIGN, PLLC  
8600 'D' JERSEY CT. RALEIGH, NC 27617  
919.480.1075

INFO@JDSDESIGNONLINE.COM  
WWW.JDSDESIGNONLINE.COM

PROJECT NO.: 19901771  
DATE: 8/26/2019

PLAN:  
240.3174

MISCELLANEOUS  
FRAMING DETAILS

D6.0

These designs and drawings are CONFIDENTIAL, and the enclosure property of KB Home Corporation, and are not to be disclosed without the express permission of KB Home Corporation. They may not be used or duplicated without the express permission of KB Home Corporation. Copyright 2019 © KB Home Corporation, all rights reserved.

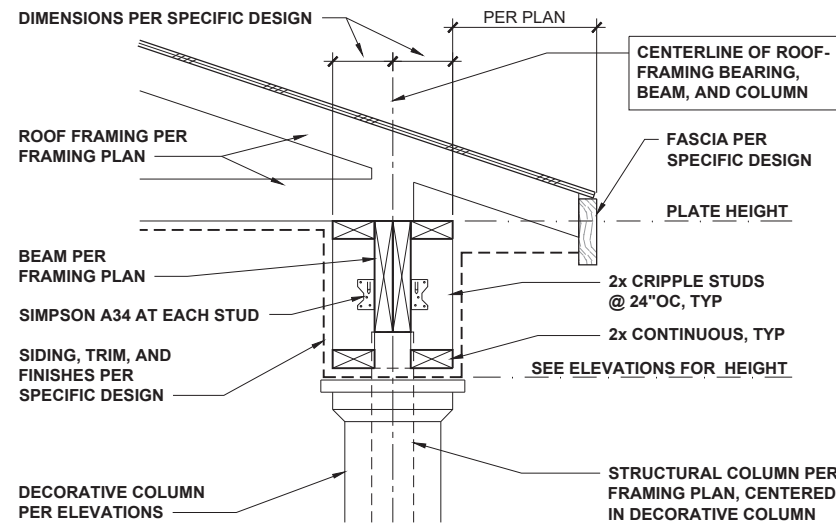

COVERED PORCH EAVES 3/4" = 1'-0" **1**

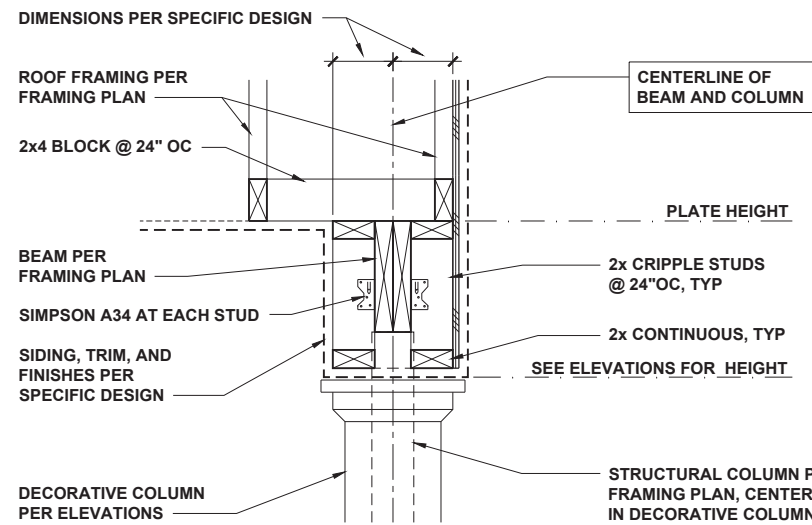

COVERED PORCH RAKE 3/4" = 1'-0" **2**

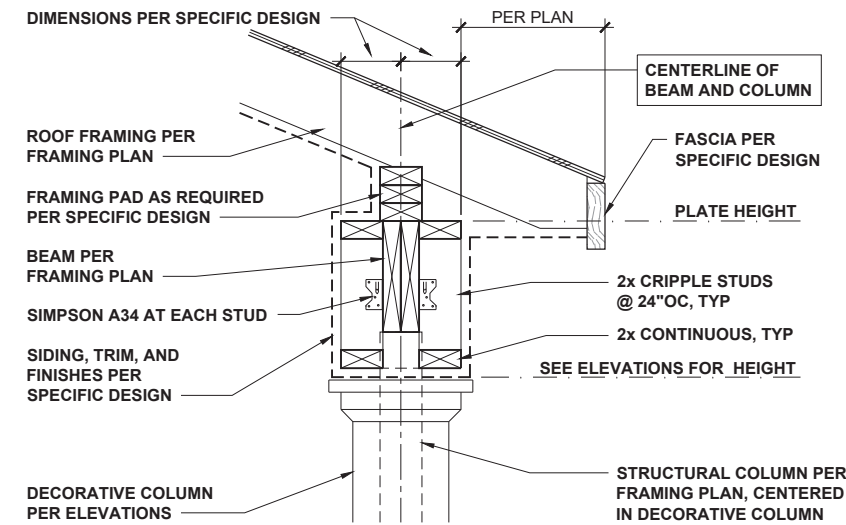

COVERED PORCH WITH SLOPING CLG 3/4" = 1'-0" **3**



KB HOME  
NORTH CAROLINA DIVISION  
4518 S. MIAMI BLVD.  
SUITE 180  
DURHAM, NC 27703  
TEL: (919) 768-7988  
FAX: (919) 472-0582

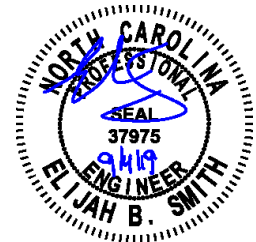

P-0961



JDS CONSULTING & DESIGN, PLLC  
8600 'D' JERSEY CT. RALEIGH, NC 27617  
919.480.1075

INFO@JDSDESIGNONLINE.COM  
WWW.JDSDESIGNONLINE.COM

PROJECT NO.: 19901771  
DATE: 8/26/2019

PLAN:  
**240.3174**

MISCELLANEOUS  
FRAMING DETAILS

**D7.0**

These designs and drawings are CONFIDENTIAL, and the enclosure property of KB Home Corporation and are not to be disclosed without the express permission of KB Home Corporation. They may not be used or duplicated without the express permission of KB Home Corporation. Copyright 2019 © KB Home Corporation, all rights reserved.



KB HOME  
NORTH CAROLINA DIVISION  
4518 S. MIAMI BLVD.  
SUITE 180  
DURHAM, NC 27703  
TEL: (919) 768-7988  
FAX: (919) 472-0582



P-0961



JDS CONSULTING & DESIGN, PLLC  
8600 'D' JERSEY CT. RALEIGH, NC 27617  
919.480.1075  
INFO@JDSDESIGNONLINE.COM  
WWW.JDSDESIGNONLINE.COM

PROJECT NO.: 19901771  
DATE: 8/26/2019

PLAN:  
240.3174

WALL BRACING DETAILS

D8.0

These designs and drawings are CONFIDENTIAL, and the enclosure property of KB Home Corporation and are not to be disclosed without the express permission of KB Home Corporation. They may not be used or duplicated without the express permission of KB Home Corporation. Copyright 2019 © KB Home Corporation, all rights reserved.

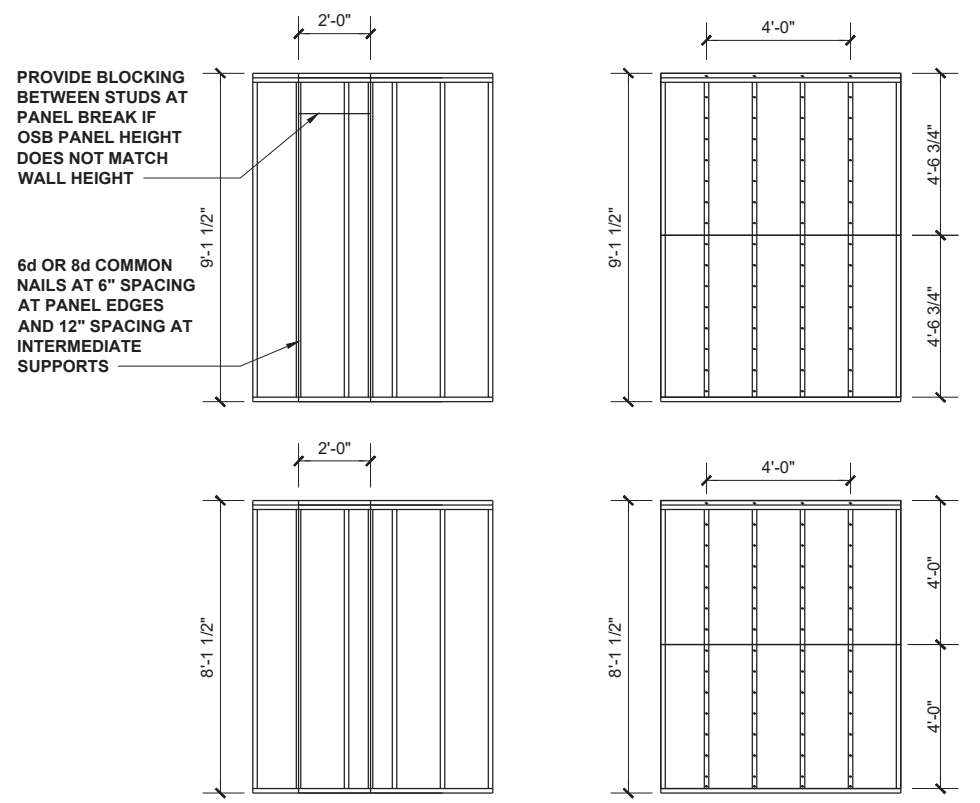
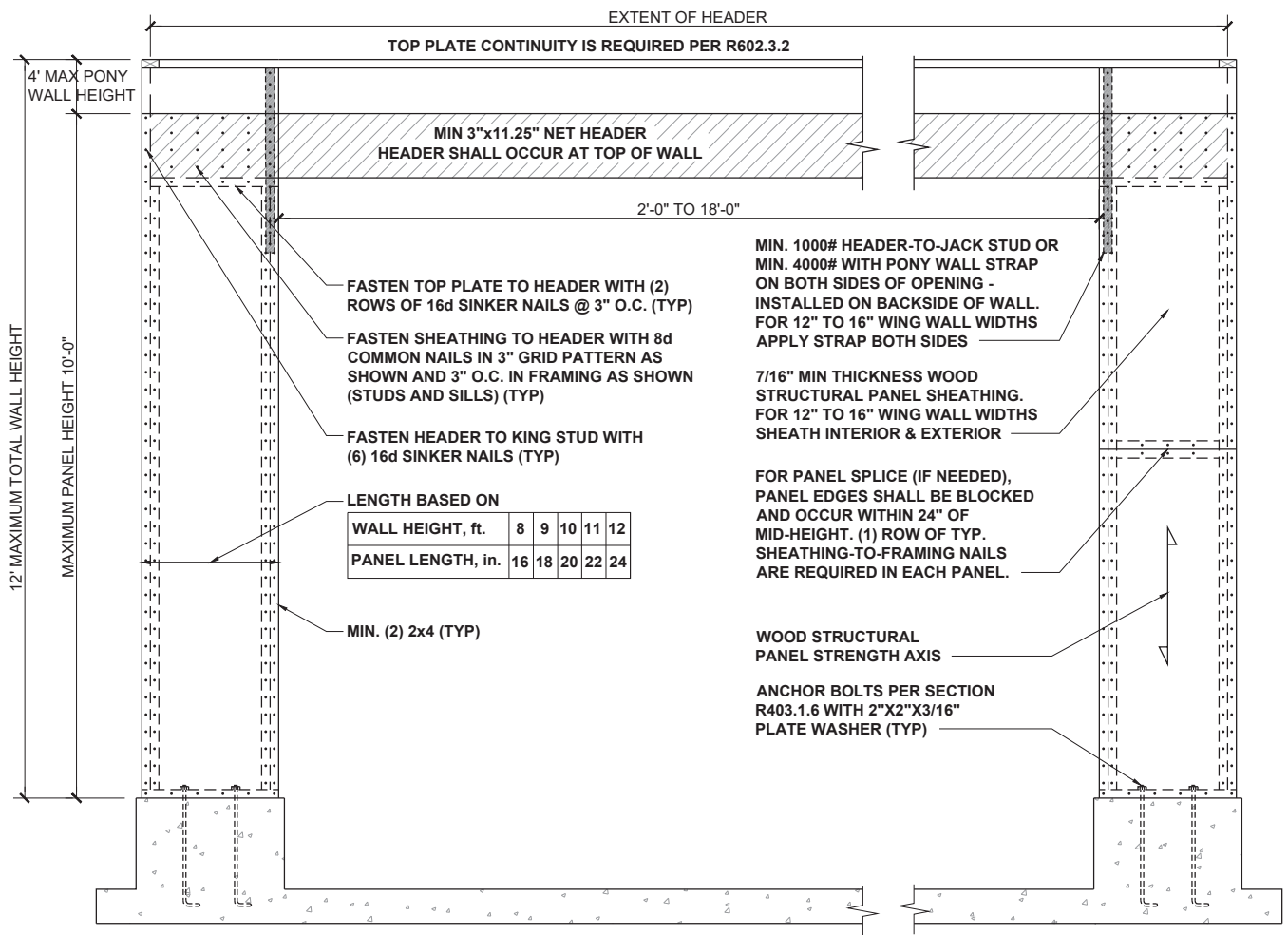

**CS-WSP - WOOD STRUCTURAL PANEL (CONTINUOUSLY SHEATHED)**

BRACED WALL PANEL 7/16" MIN. OSB SHEATHING ON ONE SIDE OF WALL. MINIMUM PANEL LENGTH 24".

**GB - GYPSUM BOARD**

BRACED WALL PANEL 1/2" GYPSUM BOARD NAILED TO STUDS AT 7" O.C. USING 5d COOLER NAILS OR #6 SCREWS. MINIMUM PANEL LENGTH 48" WHEN APPLIED TO BOTH SIDES OF WALL AND 96" WHEN APPLIED TO ONE SIDE OF WALL.

**HIGH-SPEED WIND ZONES**

FOR LOCATIONS OF 130 MPH OR MORE ULTIMATE DESIGN WIND SPEED (110 MPH OR MORE BASIC WIND SPEED IN VIRGINIA AND GEORGIA), WALLS SHALL BE BRACED PER THE LATEST ADOPTED EDITION OF THE AMERICAN SOCIETY OF CIVIL ENGINEERS PUBLICATION ASCE 7 OR STANDARD FOR RESIDENTIAL CONSTRUCTION IN HIGH-WIND REGIONS (ICC 600).

**METHOD PF: PORTAL FRAME PANEL CONSTRUCTION**

3/8" = 1'-0" **1**

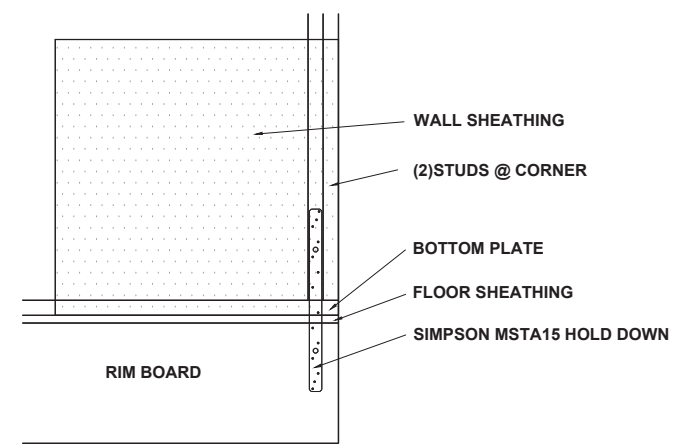

SIMPSON MSTA15 HOLD DOWN CAPACITY OF 970 POUNDS PER ANCHOR WITH (12) 10d NAILS. STRAP TO BE LOCATED AT EDGE OF BRACED WALL PANEL.

**BRACED WALL HOLD-DOWN**

NTS **3**

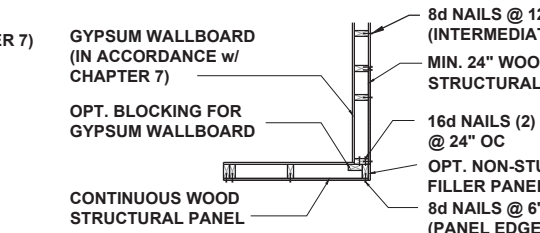
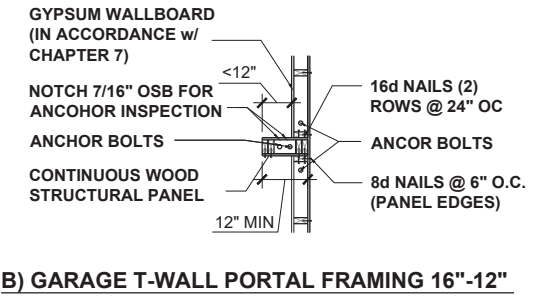
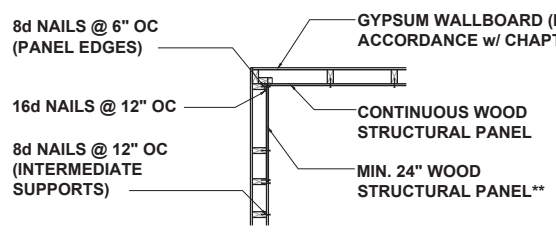
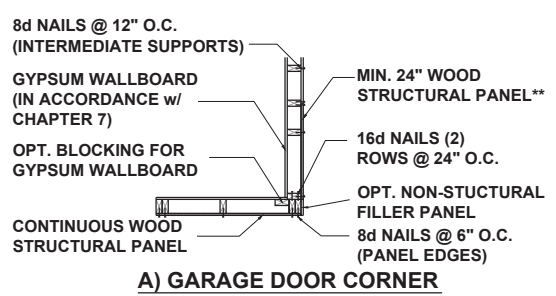

**CORNER FRAMING FOR CONTINUOUS SHEATHING**

1/4" = 1'-0" **4**

**BRACING METHODS**

3/16" = 1'-0" **2**

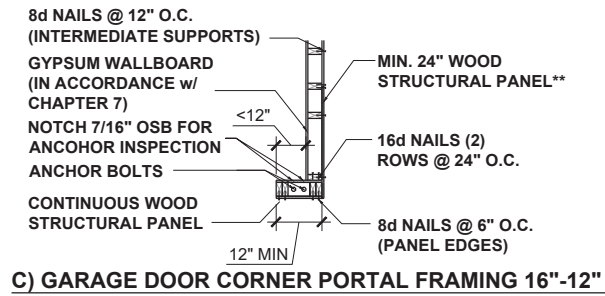

\*\* IN LIEU OF THE CORNER RETURN, A HOLD-DOWN DEVICE WITH A MINIMUM UPLIFT DESIGN VALUE OF 800# SHALL BE FASTENED TO THE CORNER STUD AND TO THE FOUNDATION OR FRAMING BELOW.

# JOIST DETAILS

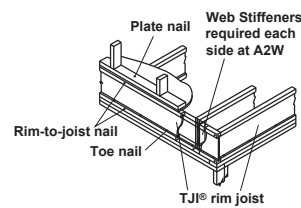

**A2 A2W** Must have 1 3/4" minimum joist bearing at ends. Attach rim joist per A3 detail.

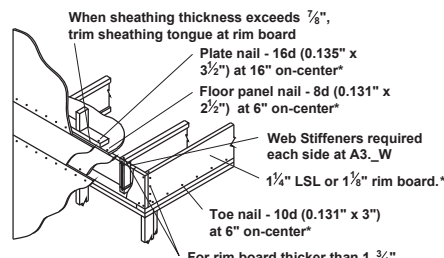

**A3** For rim board thicker than 1 3/4" - Attach Joist to rim board with one 10d (0.128"x3") nail. Top nail from joist into rim board. - Connect corner with four 10d (0.128"x3") nails. Toe nail from side of parallel closure into rim board

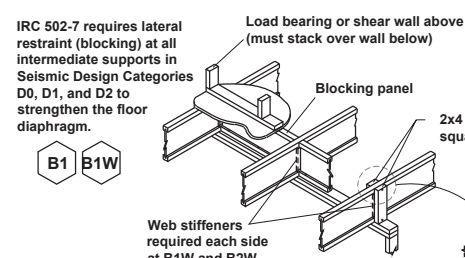

**B1 B1W** Blocking panels may be required with shear walls above or below - see detail B1

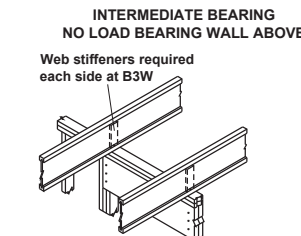

**B3 B3W** Blocking panels may be required with shear walls above or below (See detail B1)

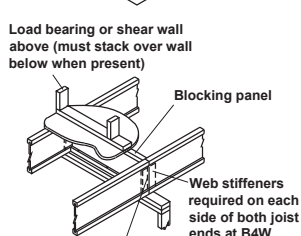

**B4 B4W** End of joists at centerline of support

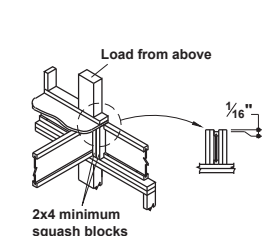

**CS** Use 2x4 minimum squash blocks to transfer load around joist

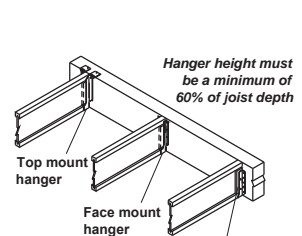

**H1** Web stiffeners required if sides of hanger do not laterally support at least 3/8" of joist top flange

## FASTENING of FLOOR PANELS

Guidelines for Closest On-Center Spacing per Row

Nail Size	I-JOIST *		Rim Board	1 1/2" LSL or wider	LVL	PSL
	110, 210, and 230 EQ.	360 and 560 EQ.	1 1/4" LSL			
8d (0.131" x 2 1/2")	4"	3"	4"	3"	3"	3"
10d (0.148" x 3")	4"	4"	4"	4"	4"	4"
16d (0.162" x 3 1/2")	6"	6"	6" (2)	6" (2)	8"	6"

- (1) One row of fasteners permitted (two at abutting panel edges) for diaphragms. Stagger nails when using 4" on-center spacing and maintain 3/8" joist and panel edge distance. For other applications, multiple rows of fasteners are permitted if the rows are offset at least 1/2" and staggered.
- (2) Can be reduced to 4" on-center if nail penetration into the narrow edge is no more than 1 3/8" (to avoid splitting).
- Recommended nailing is 12" on-center in field and 6" on-center along panel edge. Fastening requirements on engineered drawings supersede recommendations listed above.

- Recommended use of a non-polyurethane subfloor adhesive on all contact points between panels and floor framing.
- Nailing rows must be offset at least 1/2" and staggered.
- 14 ga. staples may be substituted for 8d (0.113" x 2 1/2") nails if minimum penetration of 1" into the joist or rim board is achieved.
- Maximum spacing of nails is 18" on-center for joists.

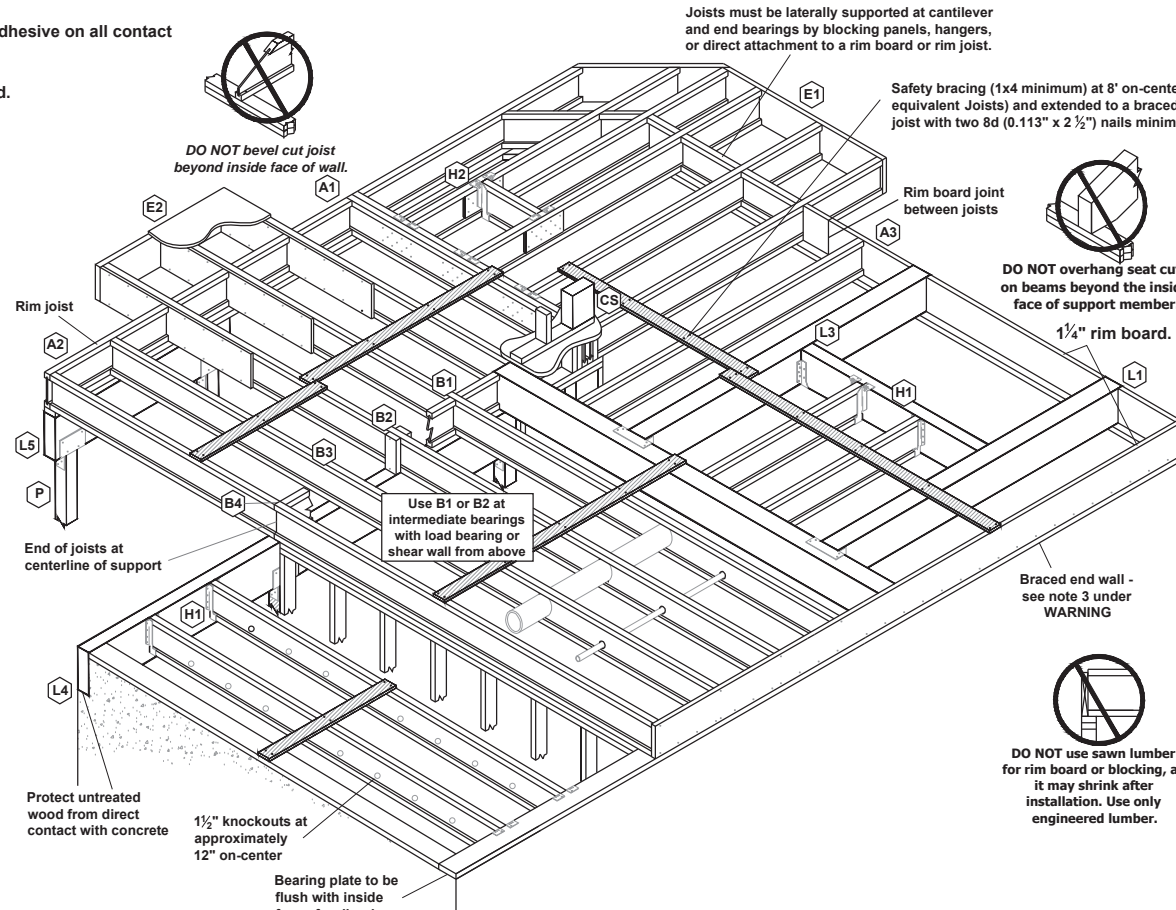

DO NOT bevel cut joist beyond inside face of wall.

Joists must be laterally supported at cantilever and end bearings by blocking panels, hangers, or direct attachment to a rim board or rim joist.

DO NOT overhang seat cuts on beams beyond the inside face of support member.

Braced end wall - see note 3 under WARNING

DO NOT use sawn lumber for rim board or blocking, as it may shrink after installation. Use only engineered lumber.

Protect untreated wood from direct contact with concrete

1 1/2" knockouts at approximately 12" on-center

Bearing plate to be flush with inside face of wall or beam

# BEAM and COLUMN DETAILS

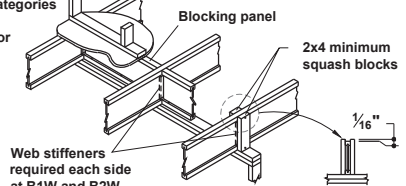

**B2 B2W** Blocking panels may be required with shear walls above or below - see detail B1

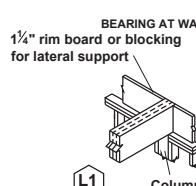

**L1** Column

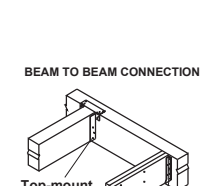

**L3** Top-mount hanger Face-mount hanger

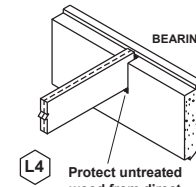

**L4** Protect untreated wood from direct contact with concrete

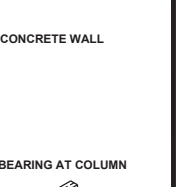

**L5** Verify column capacity and beam bearing length.

## FILLER and BACKER BLOCK SIZES \* SEE I-JOIST EQUIVALENCY CHART

I-Joists	110 EQ. *		210 EQ. *		230 or 360 EQ. *			560 EQ. *			
	9 1/2" or 11 1/4"	14"	9 1/2" or 11 1/4"	14" or 16"	9 1/2" or 11 1/4"	14" or 16"	18" or 20"	11 1/8" or 14" or 16" or 18" or 20"	Two 2x6	Two 2x8	Two 2x12
Filler Block (1) (Detail H2)	2x6	2x8	2x6 + 3/8" sheathing	2x8 + 3/8" sheathing	2x6 + 1/2" sheathing	2x8 + 1/2" sheathing	2x12 + 1/2" sheathing	Two 2x6	Two 2x8	Two 2x12	
Cantilever Filler (Detail E4)	4'-0" long	6'-0" long	2x6 + 3/8" sheathing 4'-0" long	2x10 + 3/8" sheathing 6'-0" long	2x6 + 1/2" sheathing 4'-0" long	2x10 + 1/2" sheathing 6'-0" long	Not applicable	Not applicable	Not applicable	Not applicable	
Backer Block (1) (Detail F1 or H2)	5/8" or 3/4"	3/4" or 7/8"	1" Net			2x6	2x8	2x12			

(1) If necessary, increase filler and backer block height for face mount hangers and maintain 1/8" gap at top of joist; see detail W. Filler and backer block lengths should accommodate required nailing without splitting (12" minimum for backer blocks and 24" minimum for filler blocks).

# INSTALLATION TIPS

- Subfloor adhesive will improve floor performance, but may not be required.
- Squash blocks and blocking panels carry stacked vertical loads (details B1 and B2). Packing out the web of a joist (with web stiffeners) is not a substitute for squash blocks or blocking panels.
- When joists are doubled at non-load bearing parallel partitions, space joists apart the width of the wall for plumbing or HVAC.
- Additional joist at plumbing drop (see detail).

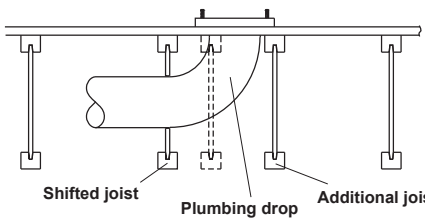

## \* I-JOIST EQUIVALENCY CHART

Depth	EQUIVALENT IN SPAN AND SPACING		
	Mfrt & Series	Mfrt & Series	Mfrt & Series
9 1/4"	TJI - 110	BCI 4500	
	TJI - 210	BCI 5000	EverEdge 20
	TJI - 230	BCI 6000	BCI 6500
11 1/8"	TJI - 110	BCI 4500	
	TJI - 210	BCI 5000	EverEdge 20
	TJI - 230	BCI 6000	BCI 6500
14"	TJI - 360	BCI 60'S	EverEdge 30
	TJI - 560	BCI 90'S	EverEdge 50/60
	TJI - 110	BCI 4500	
16"	TJI - 210	BCI 5000	
	TJI - 230	BCI 6000	EverEdge 20
	TJI - 360	BCI 60'S	EverEdge 30
16"	TJI - 560	BCI 90'S	EverEdge 50/60
	TJI - 110	BCI 4500	
	TJI - 210	BCI 5000	
16"	TJI - 230	BCI 6000	EverEdge 20
	TJI - 360	BCI 60'S	EverEdge 30
	TJI - 560	BCI 90'S	EverEdge 50/60

## JOIST NAILING REQUIREMENTS at BEARING

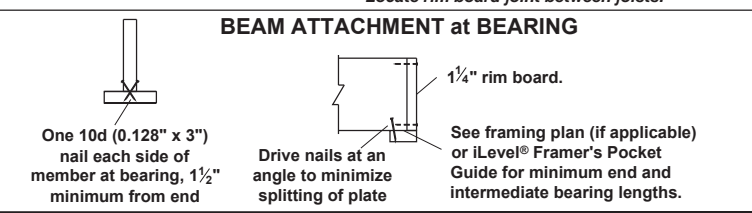
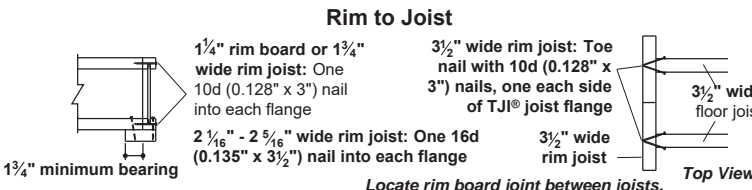
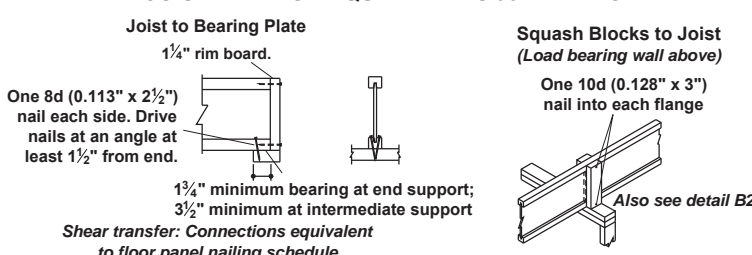

KB HOME  
NORTH CAROLINA DIVISION  
4518 S. MIAMI BLVD.  
SUITE 180  
DURHAM, NC 27703  
TEL: (919) 768-7988  
FAX: (919) 472-0582

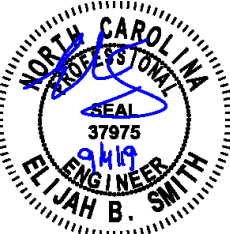

P-0961



JDS CONSULTING & DESIGN, PLLC  
8600 'D' JERSEY CT. RALEIGH, NC 27617  
919.480.1075  
INFO@JDSDESIGNONLINE.COM  
WWW.JDSDESIGNONLINE.COM

PROJECT NO.: 19901771  
DATE: 8/26/2019

PLAN:  
240.3174

ENGINEERED JOIST  
DETAILS  
**D9.0**

These designs and drawings are CONFIDENTIAL, and the enclosure property of KB Home Corporation and are not to be disclosed without the express permission of KB Home Corporation. They may not be used or duplicated without the express permission of KB Home Corporation. Copyright 2019 © KB Home Corporation, all rights reserved.