

NOTICE TO CONTRACTOR
 All construction must comply with current NC Building Codes and is subject to field inspection and verification.

APPROVED
 Limited building only review.
 Permit holder responsible for full compliance with the code.







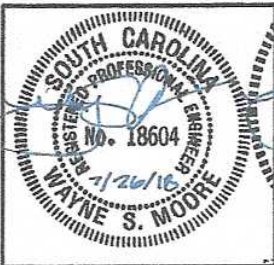

06/29/2020

DRAWING INDEX

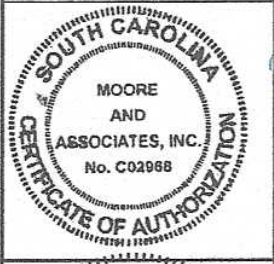
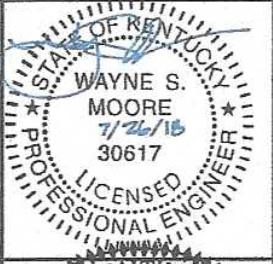
SHEET 1	PE SEAL COVER SHEET
SHEET 2	DRAWING INDEX
SHEET 3A	INSTALLATION NOTES AND SPECIFICATIONS
SHEET 3B	TYPICAL SIDE AND END ELEVATIONS
SHEET 3C	TYPICAL SIDE AND END ELEVATIONS
SHEET 4	TYPICAL RAFTER/COLUMN FRAME AND SIDE FRAMING SECTION (BOX EAVE STRUCTURE)
SHEET 4A	TYPICAL RAFTER/COLUMN FRAME AND SIDE FRAMING SECTION (BOX EAVE STRUCTURE)
SHEET 4B	TYPICAL RAFTER/COLUMN FRAME AND SIDE FRAMING SECTION (BOX EAVE STRUCTURE)
SHEET 4C	TYPICAL RAFTER/COLUMN FRAME AND SIDE FRAMING SECTION (BOX EAVE STRUCTURE)
SHEET 5	COLUMN CONNECTION DETAILS (BOX EAVE STRUCTURE)
SHEET 5A	COLUMN CONNECTION DETAILS (BOX EAVE STRUCTURE)
SHEET 6	COLUMN CONNECTION DETAILS (BOX EAVE STRUCTURE)
SHEET 6A	COLUMN CONNECTION DETAILS (BOX EAVE STRUCTURE)
SHEET 7	BASE RAIL ANCHORAGE OPTIONS
SHEET 7A	BASE RAIL ANCHORAGE OPTIONS
SHEET 8	TYPICAL END WALL AND SIDE WALL FRAMING SECTIONS
SHEET 8A	TYPICAL END WALL AND SIDE WALL FRAMING SECTIONS
SHEET 9	CONNECTION DETAILS
SHEET 10	CONNECTION DETAILS
SHEET 11	LEAN-TO OPTIONS
SHEET 11A	LEAN-TO OPTIONS
SHEET 12	VERTICAL ROOF/SIDING OPTION END AND SIDE ELEVATION AND SECTION
SHEET 12A	VERTICAL ROOF/SIDING OPTION END AND SIDE ELEVATION AND SECTION

MOORE AND ASSOCIATES ENGINEERING AND CONSULTING, INC.	DRAWN BY: AT			
	CHECKED BY: LG			
THIS DOCUMENT IS THE PROPERTY OF MOORE AND ASSOCIATES ENGINEERING AND CONSULTING. THE UNAUTHORIZED REPRODUCTION, COPYING, OR OTHERWISE USE OF THIS DOCUMENT IS STRICTLY PROHIBITED AND ANY INFRINGEMENT THEREUPON MAY BE SUBJECT TO LEGAL ACTION.	PROJECT MGR: WSM	Date: 10-22-2019	SCALE: NTS	JOB NO: 16184S
	CLIENT: JR BUILDINGS	SHT. 2	DWG. NO: SK-3	REV. 0

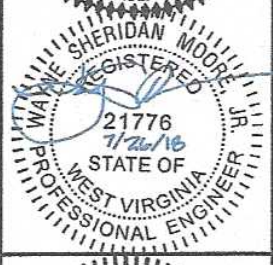
			
			
			
			
			
<p>MOORE AND ASSOCIATES ENGINEERING AND CONSULTING, INC.</p>		<p>DRAWN BY: AT</p>	
<p>THIS DOCUMENT IS THE PROPERTY OF MOORE AND ASSOCIATES ENGINEERING AND CONSULTING. THE UNAUTHORIZED REPRODUCTION, COPYING, OR OTHERWISE USE OF THIS DOCUMENT IS STRICTLY PROHIBITED AND ANY INFRINGEMENT THEREUPON MAY BE SUBJECT TO LEGAL ACTION.</p>		<p>CHECKED BY: LG</p>	
<p>PROJECT MGR: WSH</p>	<p>Date: 10-22-2019</p>	<p>SCALE: NTS</p>	<p>JOB NO: 18184S</p>
<p>CLIENT: JR BUILDINGS</p>	<p>SHT. 1</p>	<p>DWG. NO: SK-3</p>	<p>REV: 0</p>

INSTALLATION NOTES AND SPECIFICATIONS

1. DESIGN IS FOR MAXIMUM 30'-0" WIDE x 16'-0" EAVE HEIGHT ENCLOSED STRUCTURES.
2. DESIGN WAS DONE IN ACCORDANCE WITH THE 2012 NORTH CAROLINA BUILDING CODE, 2009 INTERNATIONAL BUILDING CODE (IBC), 2012 IBC AND 2015 IBC.
3. DESIGN LOADS ARE AS FOLLOWS:
 - A) DEAD LOAD = 1.5 PSF
 - B) LIVE LOAD = 12 PSF
 - C) GROUND SNOW LOAD = 35 PSF
 - = 30 PSF (W ≤ 24'-0" WITH U-CHANNEL COLLAR TIE)
4. 3-SECOND GUST ULTIMATE WIND SPEED (V_{ULT}) 105 TO 145 MPH (NOMINAL WIND SPEED 82 TO 112 MPH).
5. MAXIMUM RAFTER/COLUMN AND END COLUMN SPACING = 5.0 FEET (UNLESS NOTED OTHERWISE).
6. SIDEWALL COLUMNS AND ENDWALL COLUMNS ARE SIMILAR IN SIZE, UNLESS NOTED OTHERWISE.
7. RISK CATEGORY I.
8. WIND EXPOSURE CATEGORY B.
9. SPECIFICATIONS APPLICABLE TO 29 GAUGE METAL PANELS FASTENED DIRECTLY TO 2 1/2" x 2 1/2" - 14 GAUGE TUBE STEEL (TS) FRAMING MEMBERS (UNLESS NOTED OTHERWISE).
10. AVERAGE FASTENER SPACING ON-CENTERS ALONG RAFTERS OR HAT CHANNELS, AND COLUMNS (INTERIOR OR END) = 8 INCHES.
11. FASTENERS CONSIST OF #12-14x3/4" SELF-DRILLING FASTENER (SDF), USE CONTROL SEAL WASHER WITH EXTERIOR FASTENERS. SPECIFICATIONS APPLICABLE ONLY FOR MEAN ROOF HEIGHT OF 16 FEET OR LESS, AND ROOF SLOPES OF 14° (3:12 PITCH) OR LESS SPACING REQUIREMENTS FOR OTHER ROOF HEIGHTS AND/OR SLOPES MAY VARY.
12. GROUND ANCHORS SHALL BE INSTALLED THROUGH BASE RAIL WITHIN 6' OF EACH COLUMN.
13. STANDARD SOIL NAIL FOUNDATION SYSTEM CONSIST OF #4 REBAR W/ WELDED NUT x 36" LONG AND ARE APPLICABLE ONLY IN MEDIUM TO STIFF SOILS (SUITABLE SOIL). OPTIONAL FOUNDATION SYSTEMS MAY BE USED IN SUITABLE SOILS AND MUST BE USED IN UNSUITABLE SOILS AS NOTED.
14. WIND FORCES GOVERN OVER SEISMIC FORCES. SEISMIC PARAMETERS ANALYZED ARE:
 - SOIL SITE CLASS = D
 - RISK CATEGORY I/II/III
 - R = 3.25 I_e = 1.0
 - S_{0.5} = 1.522 V = C_sW
 - S_H = 0.839

MOORE AND ASSOCIATES ENGINEERING AND CONSULTING, INC.	DRAWN BY: AT			
	CHECKED BY: LG			
THIS DOCUMENT IS THE PROPERTY OF MOORE AND ASSOCIATES ENGINEERING AND CONSULTING. THE UNAUTHORIZED REPRODUCTION, COPYING, OR OTHERWISE USE OF THIS DOCUMENT IS STRICTLY PROHIBITED AND ANY INFRINGEMENT THEREUPON MAY BE SUBJECT TO LEGAL ACTION.	PROJECT: MGR WSH	Date: 10-22-2019	SCALE: NTS	JOB NO: 18184S
	CLIENT: JR BUILDINGS	SHT. 3A	DWG. NO: SK-3	REV: 0

BOX EAVE FRAME RAFTER STRUCTURE

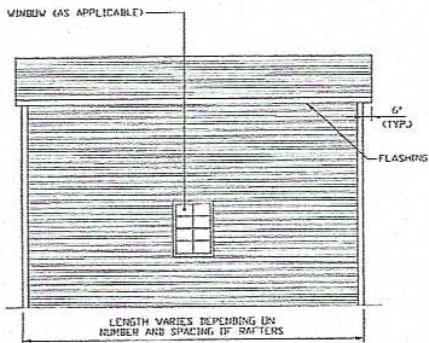

TYPICAL SIDE ELEVATION
SCALE: NTS

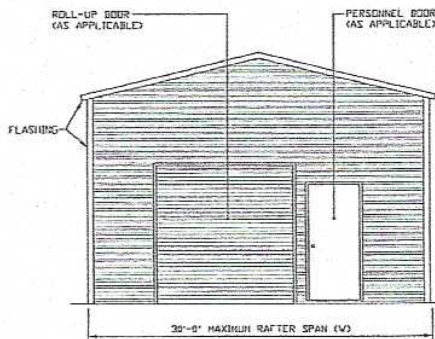

TYPICAL END ELEVATION
SCALE: NTS

MOORE AND ASSOCIATES ENGINEERING AND CONSULTING, INC.	DRAWN BY: AT			
	CHECKED BY: LG			
THIS DOCUMENT IS THE PROPERTY OF MOORE AND ASSOCIATES ENGINEERING AND CONSULTING. THE UNAUTHORIZED REPRODUCTION, COPYING, OR OTHERWISE USE OF THIS DOCUMENT IS STRICTLY PROHIBITED AND ANY INFRINGEMENT THEREUPON MAY BE SUBJECT TO LEGAL ACTION.	PROJECT MGR: WSM	Date: 10-22-2019	SCALE: NTS	JOB NO: 18184S
	CLIENT: JR BUILDINGS	SHT. 3B	DWG. NO: SK-3	REV: 0

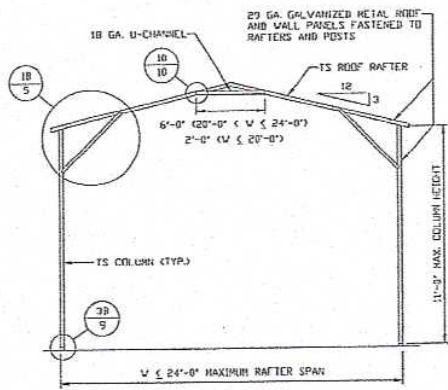

TYPICAL RAFTER/COLUMN FRAME SECTION
 SCALE: NTS

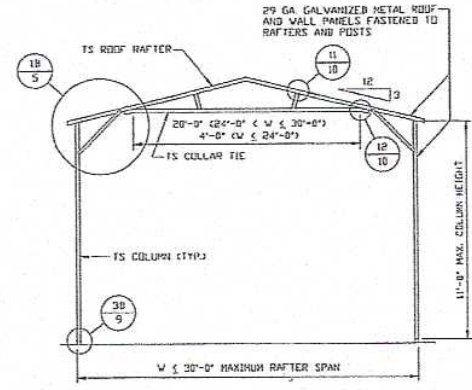

TYPICAL RAFTER/COLUMN FRAME SECTION
 SCALE: NTS

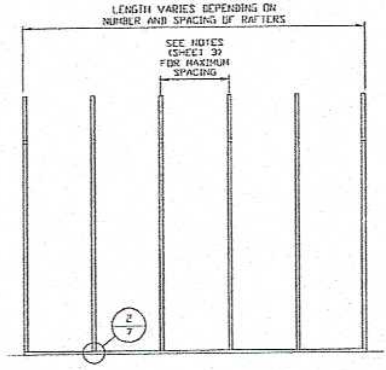

TYPICAL RAFTER/COLUMN SIDE FRAMING SECTION
 SCALE: NTS

MOORE AND ASSOCIATES ENGINEERING AND CONSULTING, INC.	DRAWN BY: AT			
	CHECKED BY: LG			
THIS DOCUMENT IS THE PROPERTY OF MOORE AND ASSOCIATES ENGINEERING AND CONSULTING. THE UNAUTHORIZED REPRODUCTION, COPYING, OR OTHERWISE USE OF THIS DOCUMENT IS STRICTLY PROHIBITED AND ANY INFRINGEMENT THEREUPON MAY BE SUBJECT TO LEGAL ACTION.	PROJECT MGR: WSM	Date: 10-22-2019	SCALE: NTS	JOB NO: 18184S
	CLIENT: JR BUILDINGS	SHT. 4A	DWG. NO: SK-3	REV: 0

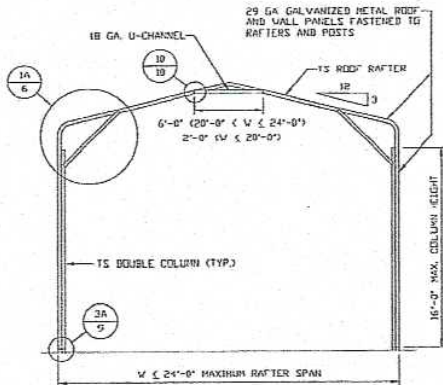

TYPICAL RAFTER/COLUMN FRAME SECTION
SCALE: NTS

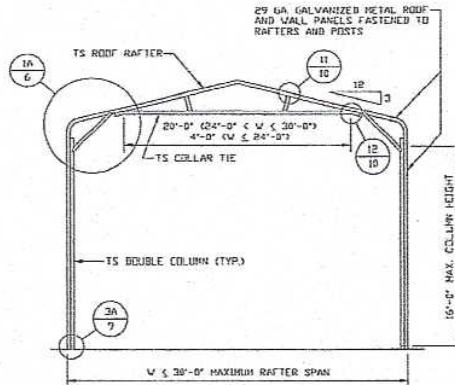

TYPICAL RAFTER/COLUMN FRAME SECTION
SCALE: NTS

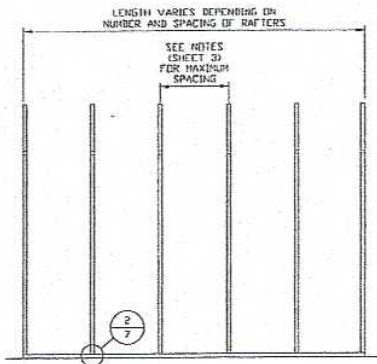

TYPICAL RAFTER/COLUMN SIDE FRAMING SECTION
SCALE: NTS

<p>MOORE AND ASSOCIATES ENGINEERING AND CONSULTING, INC.</p>		DRAWN BY: AT			
		CHECKED BY: LG			
<p>THIS DOCUMENT IS THE PROPERTY OF MOORE AND ASSOCIATES ENGINEERING AND CONSULTING. THE UNAUTHORIZED REPRODUCTION, COPYING, OR OTHERWISE USE OF THIS DOCUMENT IS STRICTLY PROHIBITED AND ANY INFRINGEMENT THEREUPON MAY BE SUBJECT TO LEGAL ACTION.</p>		PROJECT MGR: WSH	Date: 10-22-2019	SCALE: NTS	JOB NO: 18184S
		CLIENT: JR BUILDINGS	SHT. 4B	DWG. NO: SK-3	REV: 0

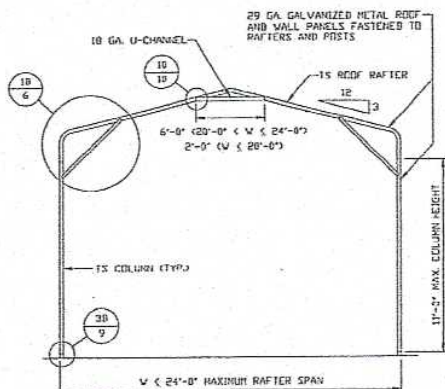

TYPICAL RAFTER/COLUMN FRAME SECTION
SCALE: NTS

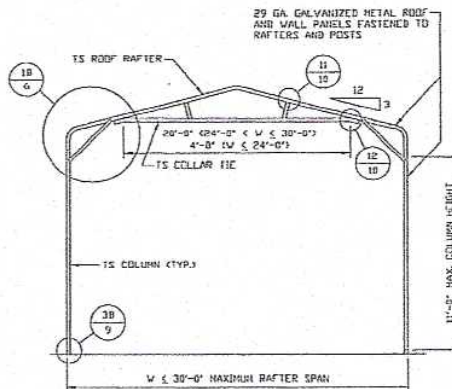

TYPICAL RAFTER/COLUMN FRAME SECTION
SCALE: NTS

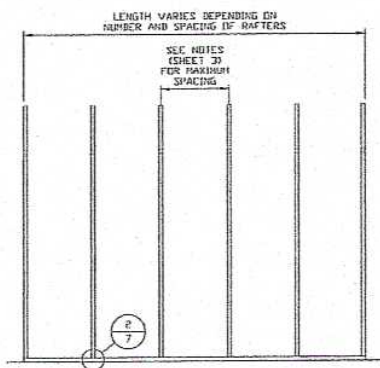

TYPICAL RAFTER/COLUMN SIDE FRAMING SECTION
SCALE: NTS

MOORE AND ASSOCIATES ENGINEERING AND CONSULTING, INC.	DRAWN BY: AT			
	CHECKED BY: LG			
THIS DOCUMENT IS THE PROPERTY OF MOORE AND ASSOCIATES ENGINEERING AND CONSULTING. THE UNAUTHORIZED REPRODUCTION, COPYING, OR OTHERWISE USE OF THIS DOCUMENT IS STRICTLY PROHIBITED AND ANY INFRINGEMENT THEREUPON MAY BE SUBJECT TO LEGAL ACTION.	PROJECT MGR: WSH	Date: 10-22-2019	SCALE: NTS	JOB NO: 18184S
	CLIENT: JR BUILDINGS	SHT. 4C	DWG. NO: SK-3	REV: 0

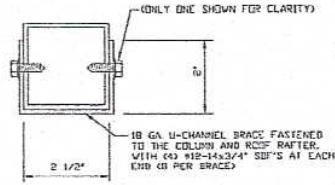
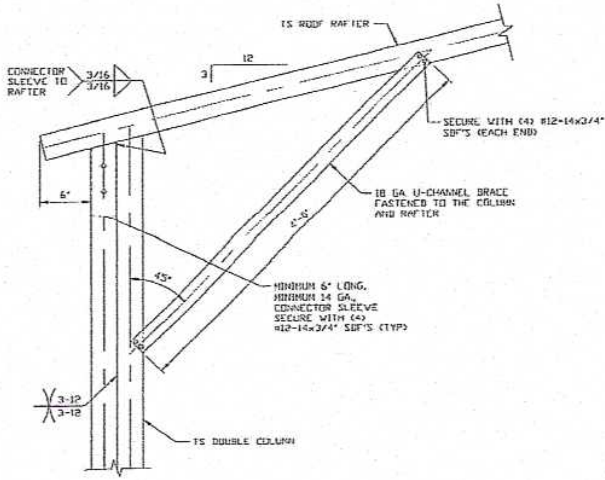

BRACE SECTION
SCALE: NTS

1A
BOX EAVE RAFTER/CORNER POST
CONNECTION DETAIL
FOR HEIGHTS 11'-0" < TO ≤ 16'-0"
SCALE: NTS

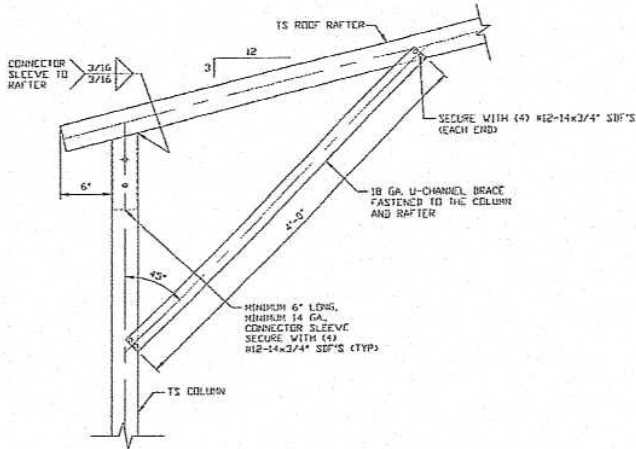

1B
BOX EAVE RAFTER/CORNER POST
CONNECTION DETAIL
FOR HEIGHTS ≤ 12'-0"
SCALE: NTS

MOORE AND ASSOCIATES ENGINEERING AND CONSULTING, INC.	DRAWN BY: AT			
	CHECKED BY: LG			
THIS DOCUMENT IS THE PROPERTY OF MOORE AND ASSOCIATES ENGINEERING AND CONSULTING. THE UNAUTHORIZED REPRODUCTION, COPYING, OR OTHERWISE USE OF THIS DOCUMENT IS STRICTLY PROHIBITED AND ANY INFRINGEMENT THEREUPON MAY BE SUBJECT TO LEGAL ACTION.	PROJECT MGR: WSM	Date: 10-22-2019	SCALE: NTS	JOB NO: 18184S
	CLIENT: JR BUILDINGS	SHT. 5	DWG. NO: SK-3	REV: 0

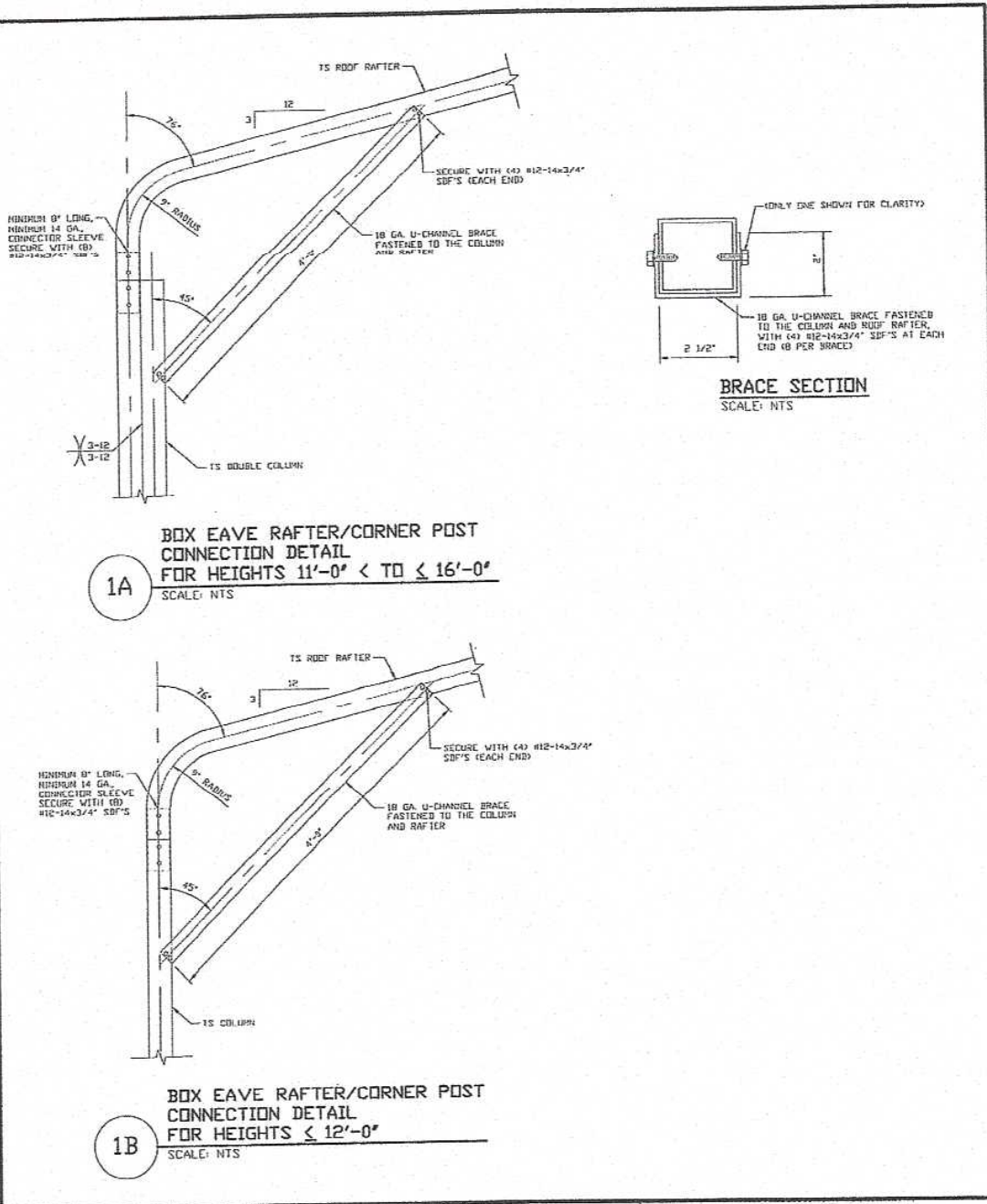

MOORE AND ASSOCIATES ENGINEERING AND CONSULTING, INC.		DRAWN BY: AT		
		CHECKED BY: LG		
PROJECT MGR: WSM		Date: 10-22-2019	SCALE: NTS	JOB NO: 18184S
CLIENT: JR BUILDINGS		SHT. 6	DWG. NO: SK-3	REV: 0

THIS DOCUMENT IS THE PROPERTY OF MOORE AND ASSOCIATES ENGINEERING AND CONSULTING, INC. UNAUTHORIZED REPRODUCTION, COPYING, OR OTHERWISE USE OF THIS DOCUMENT IS STRICTLY PROHIBITED AND ANY INFRINGEMENT THEREUPON MAY BE SUBJECT TO LEGAL ACTION.

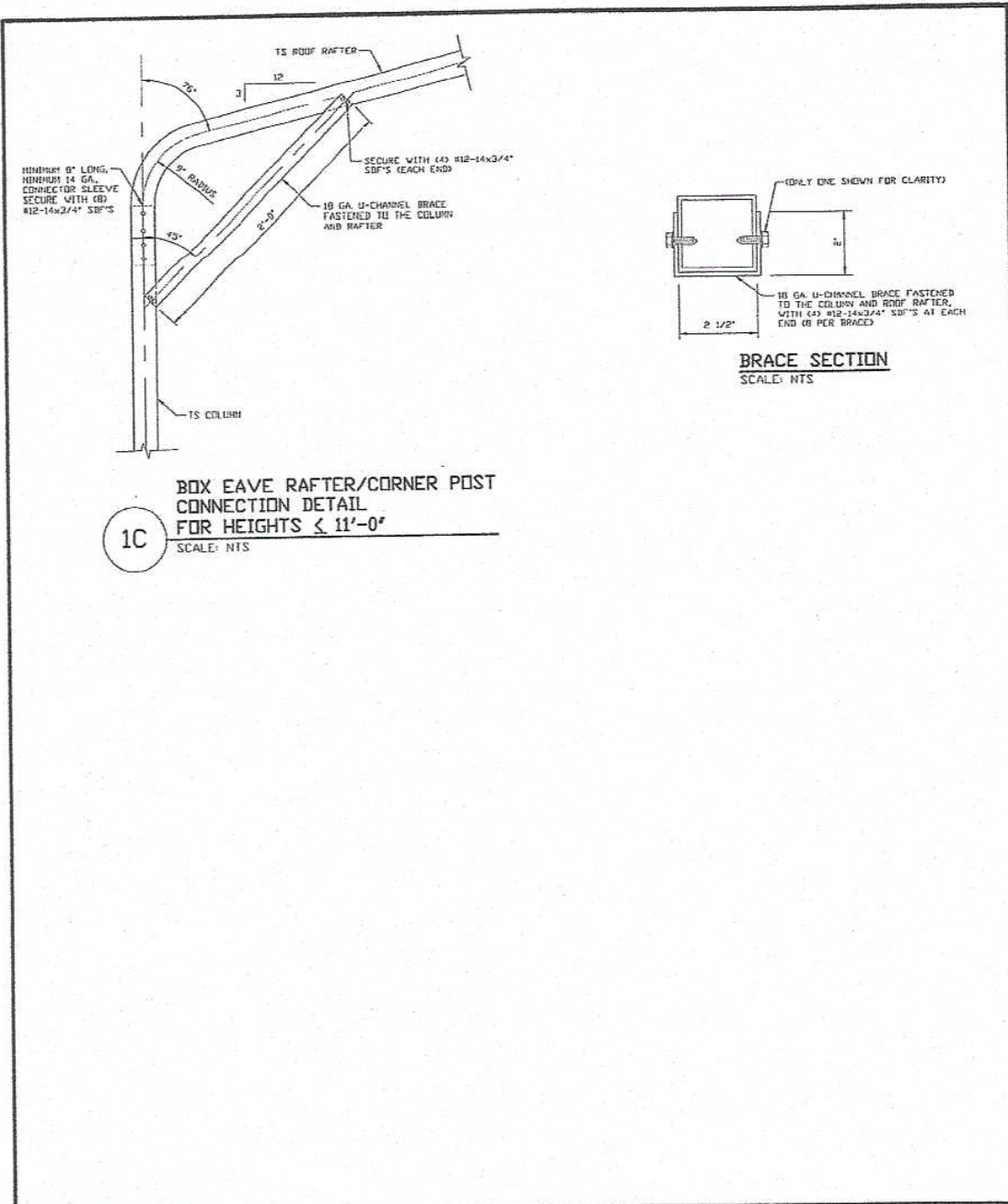

1C
BOX EAVE RAFTER/CORNER POST CONNECTION DETAIL
FOR HEIGHTS ≤ 11'-0"
 SCALE: NTS

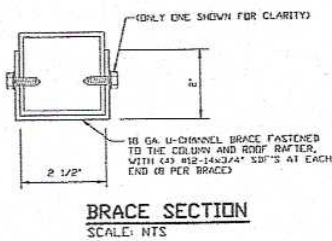

MOORE AND ASSOCIATES ENGINEERING AND CONSULTING, INC.	DRAWN BY: AT			
	CHECKED BY: LG			
THIS DOCUMENT IS THE PROPERTY OF MOORE AND ASSOCIATES ENGINEERING AND CONSULTING. THE UNAUTHORIZED REPRODUCTION, COPYING, OR OTHERWISE USE OF THIS DOCUMENT IS STRICTLY PROHIBITED AND ANY INFRINGEMENT THEREUPON MAY BE SUBJECT TO LEGAL ACTION.	PROJECT MGR: WSM	Date: 10-22-2019	SCALE: NTS	JOB NO: 18184S
	CLIENT: JR BUILDINGS	SHT. 6A	DWG. NO: SK-3	REV: 0

BASE RAIL ANCHORAGE OPTIONS

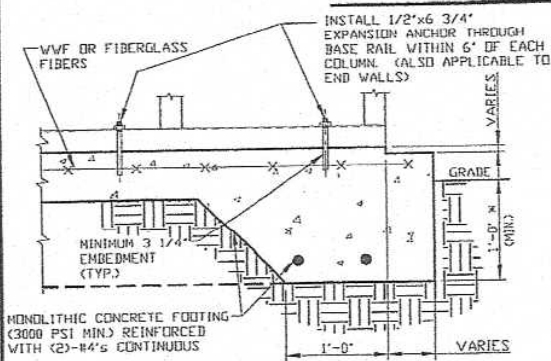

2A CONCRETE MONOLITHIC SLAB BASE RAIL ANCHORAGE
 SCALE: NTS
 MINIMUM ANCHOR EDGE DISTANCE IS 4".
 * COORDINATE WITH LOCAL CODES/ORD.

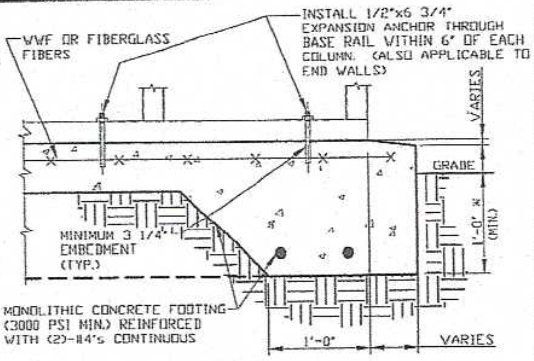

2B CONCRETE SLAB BASE RAIL ANCHORAGE
 SCALE: NTS
 MINIMUM ANCHOR EDGE DISTANCE IS 4".
 * COORDINATE WITH LOCAL CODES/ORD.

GENERAL NOTES

NOTE: CONCRETE MONOLITHIC SLAB DESIGN BASED ON MINIMUM SOIL BEARING CAPACITY OF 1,500 PSF

CONCRETE:
 CONCRETE SHALL HAVE A MINIMUM SPECIFIED COMPRESSIVE STRENGTH OF 3,000 PSI AT 28 DAYS.
COVER OVER REINFORCING STEEL:
 FOR FOUNDATIONS, MINIMUM CONCRETE COVER OVER REINFORCING BARS SHALL BE PER ACI-318:
 3" IN FOUNDATIONS WHERE THE CONCRETE IS CAST AGAINST AND PERMANENTLY IN CONTACT WITH THE EARTH OR EXPOSED TO THE EARTH OR WEATHER, AND 1 1/2" ELSEWHERE.

REINFORCING STEEL:
 THE TURNDOWN REINFORCING STEEL SHALL BE ASTM A615 GRADE 60. THE SLAB REINFORCEMENT SHALL BE WELDED WIRE FABRIC MEETING ASTM A185 OR FIBERGLASS FIBER REINFORCEMENT.

REINFORCEMENT MAY BE BENT IN THE SHOP OR THE FIELD PROVIDED:

1. REINFORCEMENT IS BENT COLD.
2. THE DIAMETER OF THE BEND, MEASURED ON THE INSIDE OF THE BAR, IS NOT LESS THAN SIX-BAR DIAMETERS.
3. REINFORCEMENT PARTIALLY EMBEDDED IN CONCRETE SHALL NOT BE FIELD BENT.

HELIX ANCHOR NOTES:

1. FOR VERY DENSE AND/OR CEMENTED SANDS, COARSE GRAVEL AND COBBLES, CALICHE, PRELOADED SILTS AND CLAYS, USE MINIMUM (2) 4" HELICES WITH MINIMUM 30" EMBEDMENT OR SINGLE 6" HELIX WITH MINIMUM 50" EMBEDMENT.
2. FOR CORAL USE MINIMUM (2) 4" HELICES WITH MINIMUM 30" EMBEDMENT OR SINGLE 6" HELIX WITH MINIMUM 50" EMBEDMENT.
3. FOR MEDIUM DENSE COARSE SANDS, SANDY GRAVELS, VERY STIFF SILTS, AND CLAYS USE MINIMUM (2) 4" HELICES WITH MINIMUM 30 INCH EMBEDMENT OR SINGLE 6" HELIX WITH MINIMUM 50" EMBEDMENT.
4. FOR LOOSE TO MEDIUM DENSE SANDS, FIRM TO STIFF CLAYS AND SILTS ALLUVIAL FILL, USE MINIMUM (2) 6" HELICES WITH MINIMUM 50" EMBEDMENT.
5. FOR VERY LOOSE TO MEDIUM DENSE SANDS, FIRM TO STIFFER CLAYS AND SILTS, ALLUVIAL FILL, USE MINIMUM (2) 8" HELICES WITH MINIMUM 60" EMBEDMENT.

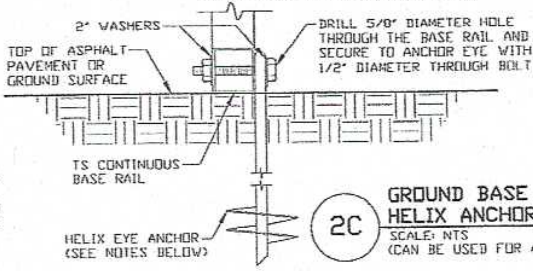

2C GROUND BASE HELIX ANCHORAGE
 SCALE: NTS
 (CAN BE USED FOR ASPHALT)

MOORE AND ASSOCIATES ENGINEERING AND CONSULTING, INC.	DRAWN BY: AT			
	CHECKED BY: LG			
THIS DOCUMENT IS THE PROPERTY OF MOORE AND ASSOCIATES ENGINEERING AND CONSULTING. THE UNAUTHORIZED REPRODUCTION, COPYING OR OTHERWISE USE OF THIS DOCUMENT IS STRICTLY PROHIBITED AND ANY INFRINGEMENT THEREUPON MAY BE SUBJECT TO LEGAL ACTION.	PROJECT MGR: VSM	Date: 10-22-2019	SCALE: NTS	JOB NO: 18184S
	CLIENT: JR BUILDINGS	SHT. 7	DWG. NO: SK-3	REV: 0

BASE RAIL ANCHORAGE OPTIONS

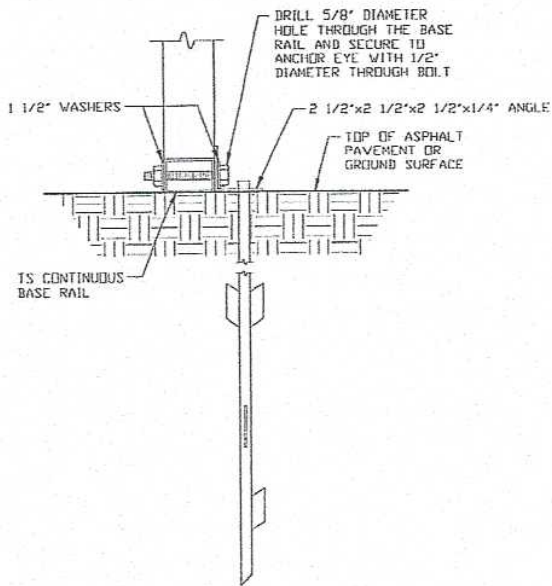

2D ASPHALT BASE ANCHORAGE
SCALE: NTS

MOORE AND ASSOCIATES ENGINEERING AND CONSULTING, INC.	DRAWN BY: AT			
	CHECKED BY: LG			
THIS DOCUMENT IS THE PROPERTY OF MOORE AND ASSOCIATES ENGINEERING AND CONSULTING. THE UNAUTHORIZED REPRODUCTION, COPYING, OR OTHERWISE USE OF THIS DOCUMENT IS STRICTLY PROHIBITED AND ANY INFRINGEMENT THEREUPON MAY BE SUBJECT TO LEGAL ACTION.	PROJECT MGR: WSM	Date: 10-22-2019	SCALE: NTS	JOB NO: 18184S
	CLIENT: JR BUILDINGS	SHT. 7A	DWG. NO: SK-3	REV: 0

BOX EAVE RAFTER END WALL AND SIDE WALL OPENINGS

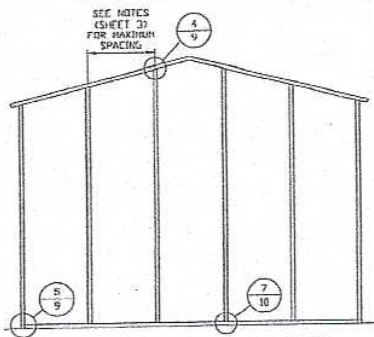

TYPICAL BOX EAVE RAFTER END WALL FRAMING SECTION

SCALE: NTS

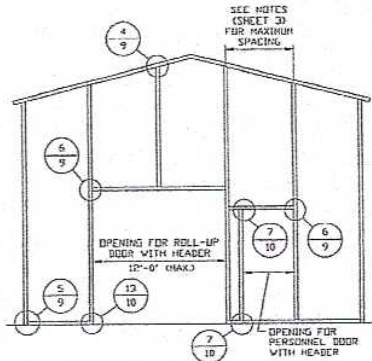

TYPICAL BOX EAVE RAFTER END WALL OPENINGS FRAMING SECTION

SCALE: NTS

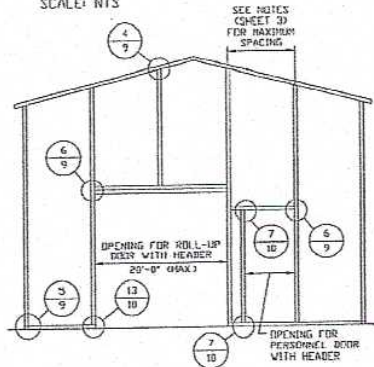

TYPICAL BOX EAVE RAFTER END WALL OPENINGS FRAMING SECTION

SCALE: NTS

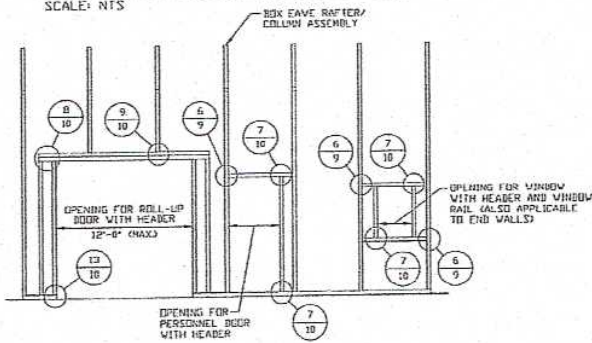

TYPICAL BOX EAVE RAFTER SIDE WALL OPENINGS FRAMING SECTION

SCALE: NTS

**MOORE AND ASSOCIATES
ENGINEERING AND CONSULTING, INC.**

DRAWN BY: AT

CHECKED BY: LG

PROJECT MGR: WSH

Date: 10-22-2019

SCALE: NTS

JOB NO: 181845

CLIENT: JR BUILDINGS

SHT. 8

DWG. NO: SK-3

REV: 0

THIS DOCUMENT IS THE PROPERTY OF MOORE AND ASSOCIATES ENGINEERING AND CONSULTING. THE UNAUTHORIZED REPRODUCTION, COPYING, OR OTHERWISE USE OF THIS DOCUMENT IS STRICTLY PROHIBITED AND ANY INFRINGEMENT THEREUPON MAY BE SUBJECT TO LEGAL ACTION.

BOX EAVE RAFTER END WALL AND SIDE WALL OPENINGS

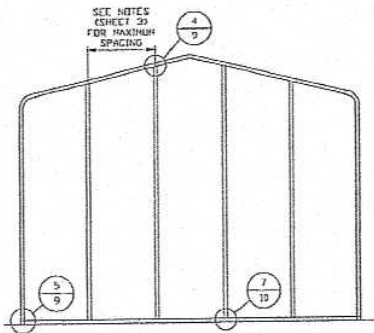

TYPICAL BOX EAVE RAFTER END WALL FRAMING SECTION
SCALE: NTS

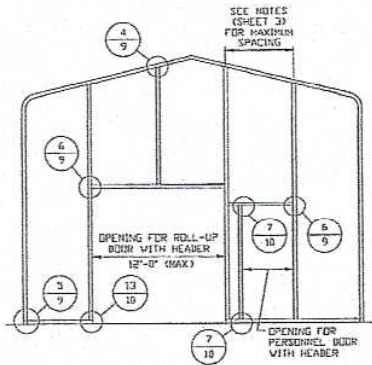

TYPICAL BOX EAVE RAFTER END WALL OPENINGS FRAMING SECTION
SCALE: NTS

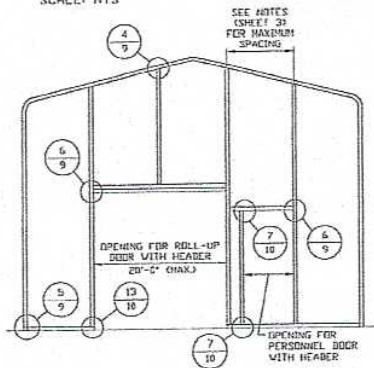

TYPICAL BOX EAVE RAFTER END WALL OPENINGS FRAMING SECTION
SCALE: NTS

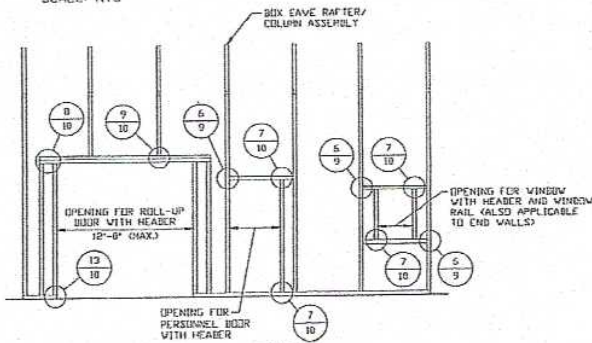

TYPICAL BOX EAVE RAFTER SIDE WALL OPENINGS FRAMING SECTION
SCALE: NTS

**MOORE AND ASSOCIATES
ENGINEERING AND CONSULTING, INC.**

DRAWN BY: AT

CHECKED BY LG

THIS DOCUMENT IS THE PROPERTY OF MOORE AND ASSOCIATES ENGINEERING AND CONSULTING. THE UNAUTHORIZED REPRODUCTION, COPYING, OR OTHERWISE USE OF THIS DOCUMENT IS STRICTLY PROHIBITED AND ANY INFRINGEMENT THEREUPON MAY BE SUBJECT TO LEGAL ACTION.

PROJECT MGR: WSM

Date: 10-22-2019

SCALE: NTS

JOB NO: 18184S

CLIENT: JR BUILDINGS

SHT. 0A

DWG. NO: SK-3

REV: 0

CONNECTION DETAILS

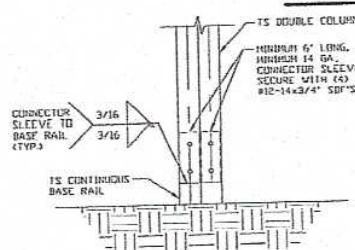

3A POST/BASE RAIL CONNECTION DETAIL
SCALE: NTS

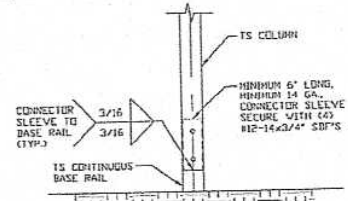

3B POST/BASE RAIL CONNECTION DETAIL
SCALE: NTS

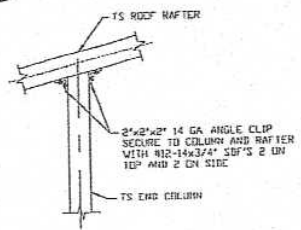

4 END COLUMN/RAFTER CONNECTION DETAIL
SCALE: NTS

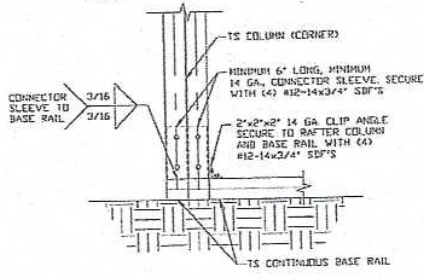

5A END COLUMN/BASE RAIL CONNECTION DETAIL
SCALE: NTS

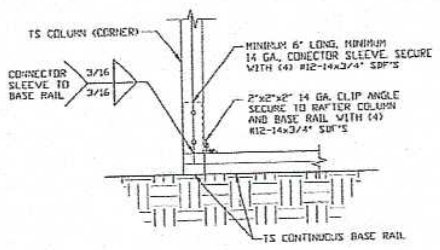

5B END COLUMN/BASE RAIL CONNECTION DETAIL
SCALE: NTS

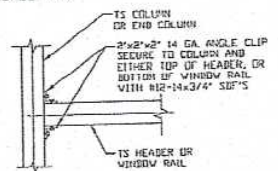

6 COLUMN OR WINDOW RAIL TO POST CONNECTION DETAIL
SCALE: NTS

**MOORE AND ASSOCIATES
ENGINEERING AND CONSULTING, INC.**

DRAWN BY: AT			
CHECKED BY: LG			
PROJECT MGR: WSM	Date: 10-22-2019	SCALE: NTS	JOB NO: 18184S
CLIENT: JR BUILDINGS	SHT. 9	DWG. NO: SK-3	REV: 0

THIS DOCUMENT IS THE PROPERTY OF MOORE AND ASSOCIATES ENGINEERING AND CONSULTING, INC. UNAUTHORIZED REPRODUCTION, COPYING, OR OTHERWISE USE OF THIS DOCUMENT IS STRICTLY PROHIBITED AND ANY INFRINGEMENT THEREUPON MAY BE SUBJECT TO LEGAL ACTION.

CONNECTION DETAILS

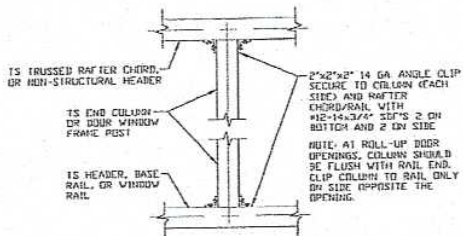

7 COLUMN TO HEADER, BASE RAIL, OR WINDOW RAIL CONNECTION DETAIL

SCALE: NTS

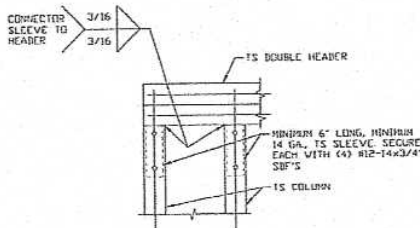

8 DOUBLE HEADER/COLUMN CONNECTION DETAIL

SCALE: NTS

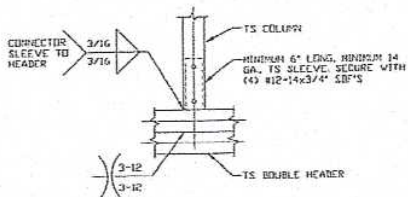

9 COLUMN/DOUBLE HEADER CONNECTION DETAIL

SCALE: NTS

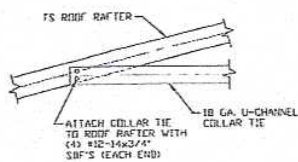

10 COLLAR TIE CONNECTION DETAIL

SCALE: NTS

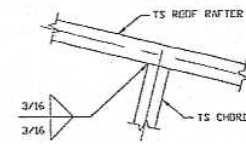

11 RAFTER TO CHORD CONNECTION DETAIL

SCALE: NTS

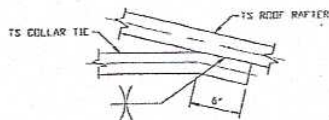

12 COLLAR TIE CONNECTION DETAIL

SCALE: NTS

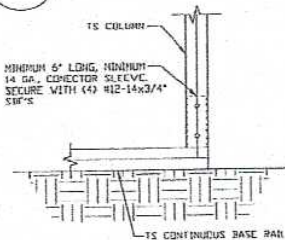

13 COLUMN/BASE RAIL CONNECTION DETAIL

SCALE: NTS

**MOORE AND ASSOCIATES
ENGINEERING AND CONSULTING, INC.**

DRAWN BY: AT

CHECKED BY: LG

PROJECT MGR: WSM

Date: 10-22-2019

SCALE: NTS

JOB NO: 18184S

CLIENT: JR BUILDINGS

SHT. 10

DWG. NO: SK-3

REV: 0

THIS DOCUMENT IS THE PROPERTY OF MOORE AND ASSOCIATES ENGINEERING AND CONSULTING. THE UNAUTHORIZED REPRODUCTION, COPYING, OR OTHERWISE USE OF THIS DOCUMENT IS STRICTLY PROHIBITED AND ANY INFRINGEMENT THEREUPON MAY BE SUBJECT TO LEGAL ACTION.

CONNECTION DETAILS

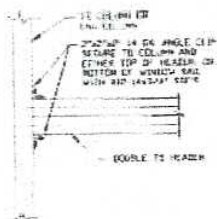

**DOUBLE HEADER TO COLUMN
CONNECTION DETAIL**

14

SCALE: NTS

**MOORE AND ASSOCIATES
ENGINEERING AND CONSULTING, INC.**

DRAWN BY: AT

CHECKED BY: PH

PROJECT MGR: VSM

CLIENT: JR BUILDINGS

DATE: 10-22-2019

SHT. 10A

SCALE: NTS

DWG. NO. SK-3

JOB NO. 18184S/
1824MS

REV. 1

THIS DOCUMENT IS THE PROPERTY OF MOORE AND ASSOCIATES ENGINEERING AND CONSULTING. THE UNAUTHORIZED REPRODUCTION, COPYING, OR OTHERWISE USE OF THIS DOCUMENT IS STRICTLY PROHIBITED AND ANY INFRINGEMENT THEREUPON MAY BE SUBJECT TO LEGAL ACTION.

BOX EAVE RAFTER LEAN-TO OPTIONS

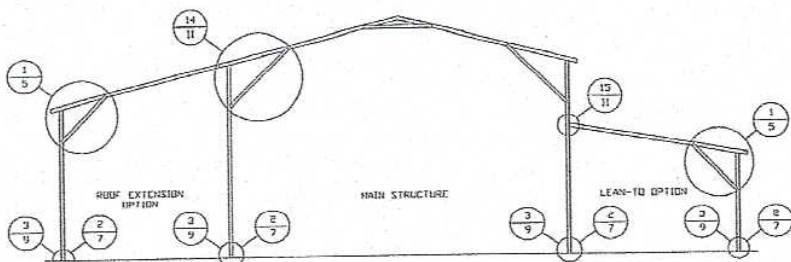

TYPICAL BOX EAVE RAFTER LEAN-TO OPTIONS FRAMING SECTION (BOTH OPTIONS SHOWN)

SCALE: NTS
 MAXIMUM WIDTH OF ROOF EXTENSION AND LEAN-TO OPTION IS 12'-0".

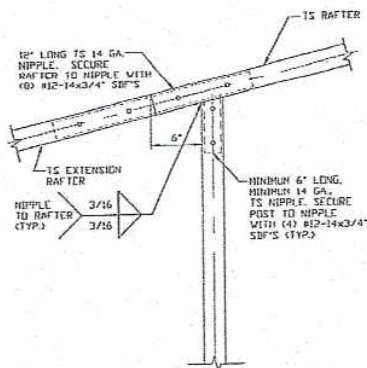

14 ROOF EXTENSION RAFTER/CORNER POST DETAIL FOR WIDTHS $\leq 12'-0"$

SCALE: NTS

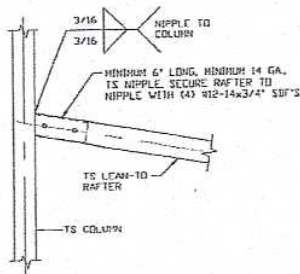

15A LEAN-TO RAFTER TO RAFTER POST CONNECTION DETAIL FOR WIDTHS $\leq 12'-0"$

SCALE: NTS

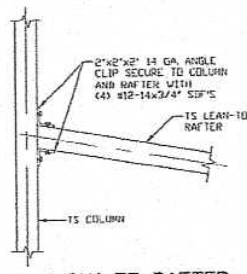

15B LEAN-TO RAFTER TO RAFTER POST CONNECTION DETAIL FOR WIDTHS $\leq 12'-0"$

SCALE: NTS

MOORE AND ASSOCIATES
 ENGINEERING AND CONSULTING, INC.

DRAWN BY: AT

CHECKED BY: LG

PROJECT MGR: WSH

Date: 10-22-2019

SCALE: NTS

JOB NO: 18184S

CLIENT: JR BUILDINGS

SHT. 11

DWG. NO: SK-3

REV: 0

THIS DOCUMENT IS THE PROPERTY OF MOORE AND ASSOCIATES ENGINEERING AND CONSULTING. THE UNAUTHORIZED REPRODUCTION, COPYING, OR OTHERWISE USE OF THIS DOCUMENT IS STRICTLY PROHIBITED AND ANY INFRINGEMENT THEREUPON MAY BE SUBJECT TO LEGAL ACTION.

BOW EAVE RAFTER LEAN-TO OPTIONS

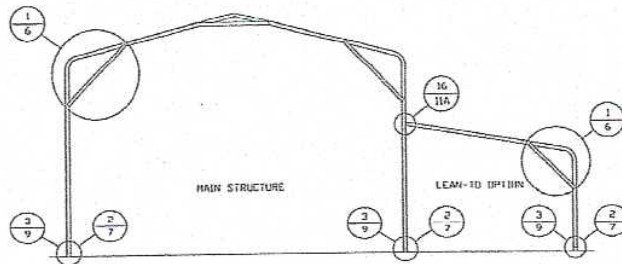

TYPICAL BOW EAVE RAFTER LEAN-TO OPTIONS FRAMING SECTION

SCALE: NTS
 MAXIMUM WIDTH OF LEAN-TO OPTION IS 12'-0".

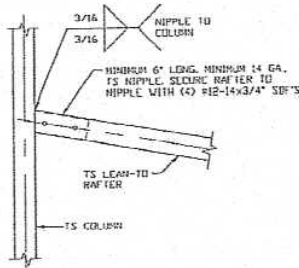

LEAN-TO RAFTER TO RAFTER POST CONNECTION DETAIL FOR WIDTHS \leq 12'-0"

16A

SCALE: NTS

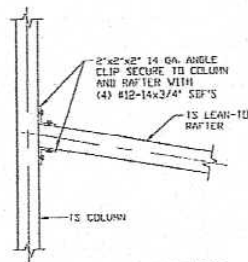

LEAN-TO RAFTER TO RAFTER POST CONNECTION DETAIL FOR WIDTHS \leq 12'-0"

16B

SCALE: NTS

**MOORE AND ASSOCIATES
 ENGINEERING AND CONSULTING, INC.**

DRAWN BY: AT

CHECKED BY: LG

PROJECT MGR: WSH

Date: 10-22-2019

SCALE: NTS

JOB NO: 18184S

CLIENT: JR BUILDINGS

SHT. 11A

DWG. NO: SK-3

REV: 0

THIS DOCUMENT IS THE PROPERTY OF MOORE AND ASSOCIATES ENGINEERING AND CONSULTING. THE UNAUTHORIZED REPRODUCTION, COPYING, OR OTHERWISE USE OF THIS DOCUMENT IS STRICTLY PROHIBITED AND ANY INFRINGEMENT THEREUPON MAY BE SUBJECT TO LEGAL ACTION.

BOX EAVE RAFTER VERTICAL ROOF/SIDING OPTION

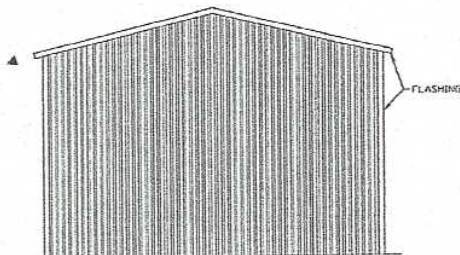

**TYPICAL END ELEVATION
VERTICAL ROOF/SIDING**
SCALE: NTS

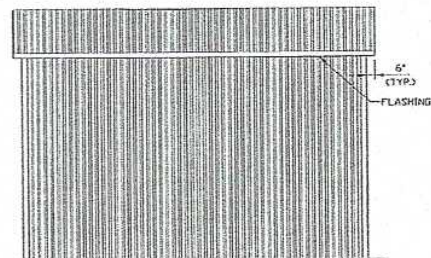

**TYPICAL SIDE ELEVATION
VERTICAL ROOF/SIDING**
SCALE: NTS

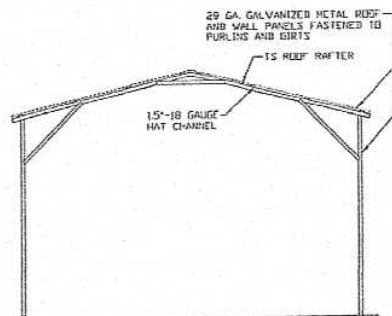

**TYPICAL SECTION
VERTICAL ROOF/SIDING OPTION**
SCALE: NTS

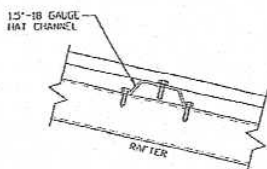

PANEL ATTACHMENT
(ALTERNATE FOR VERTICAL ROOF PANELS)
SCALE: NTS

**MOORE AND ASSOCIATES
ENGINEERING AND CONSULTING, INC.**

DRAWN BY: AT

CHECKED BY: LG

PROJECT MGR: WSM

Date: 10-22-2019

SCALE: NTS

JOB NO: 18184S

CLIENT: JR BUILDINGS

SHT. 12

DWG. NO: SK-3

REV: 0

THIS DOCUMENT IS THE PROPERTY OF MOORE AND ASSOCIATES ENGINEERING AND CONSULTING. THE UNAUTHORIZED REPRODUCTION, COPYING, OR OTHERWISE USE OF THIS DOCUMENT IS STRICTLY PROHIBITED AND ANY INFRINGEMENT THEREUPON MAY BE SUBJECT TO LEGAL ACTION.

BOX EAVE RAFTER VERTICAL ROOF/SIDING OPTION

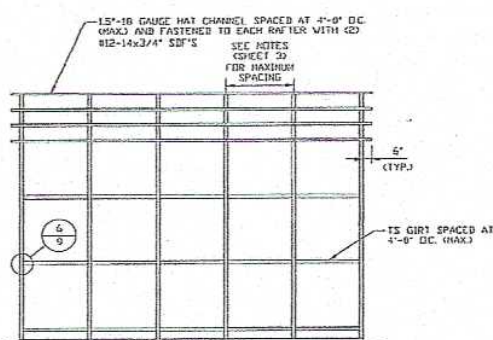

TYPICAL FRAMING SECTION
VERTICAL ROOF/SIDING OPTION
WITH TS GIRTS

SCALE: NTS

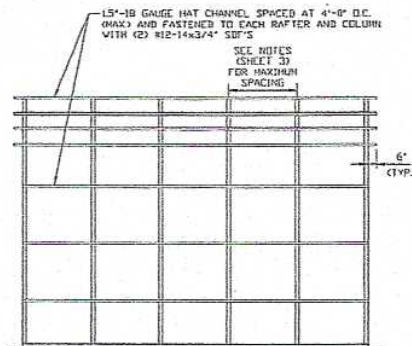

TYPICAL FRAMING SECTION
VERTICAL ROOF/SIDING OPTION
WITH HAT CHANNEL GIRTS

SCALE: NTS

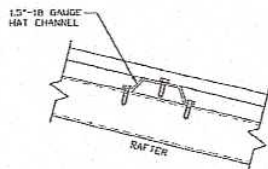

PANEL ATTACHMENT

(ALTERNATE FOR VERTICAL ROOF PANELS)

SCALE: NTS

MOORE AND ASSOCIATES ENGINEERING AND CONSULTING, INC.	DRAWN BY: AT			
	CHECKED BY: LG			
THIS DOCUMENT IS THE PROPERTY OF MOORE AND ASSOCIATES ENGINEERING AND CONSULTING. THE UNAUTHORIZED REPRODUCTION, COPYING, OR OTHERWISE USE OF THIS DOCUMENT IS STRICTLY PROHIBITED AND ANY INFRINGEMENT THEREUPON MAY BE SUBJECT TO LEGAL ACTION.	PROJECT MGR: WSM	Date: 10-22-2019	SCALE: NTS	JOB NO: 18184S
	CLIENT: JR BUILDINGS	SHT. 12A	DWG. NO: SK-3	REV: 0