

SHEET	DESCRIPTION
1	OVERVIEW
2	FOUNDATION
3	WALL FRAMING
4	MAIN ROOF FRAMING
5	PORCH OVERVIEW
6	PORCH FRAMING

CORY WYAND (HOMEOWNER) - 20 BLAIRWOOD DRIVE

TITLE

16'X20' GARDEN SHED WITH GABLE PORCH

SIZE	DWG NO	REV
C	WYAND_SHED	A
SCALE: 0.020	UNIT WT: INCHES UNLESS NOTED	SHEET 1 OF 6

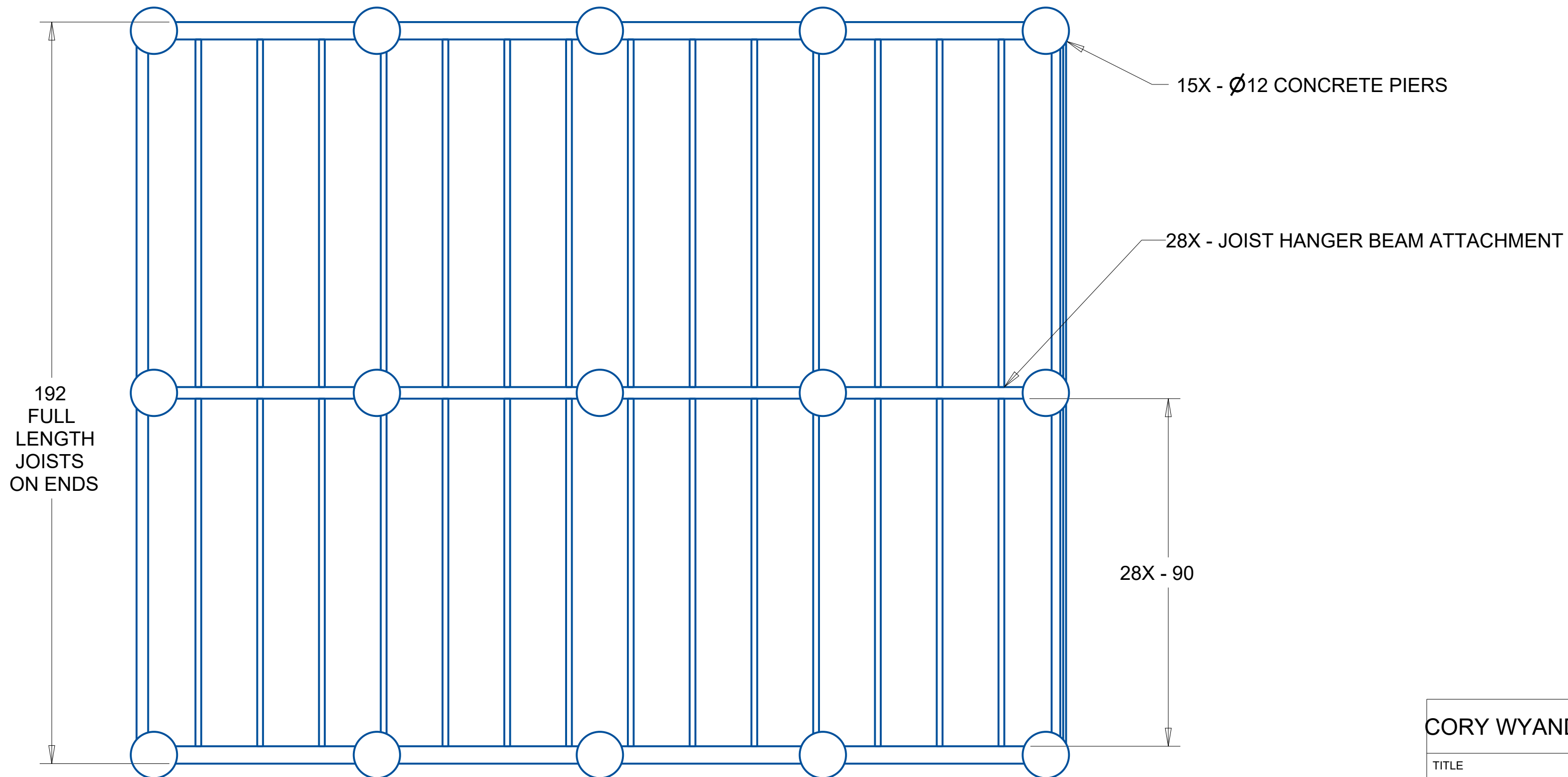
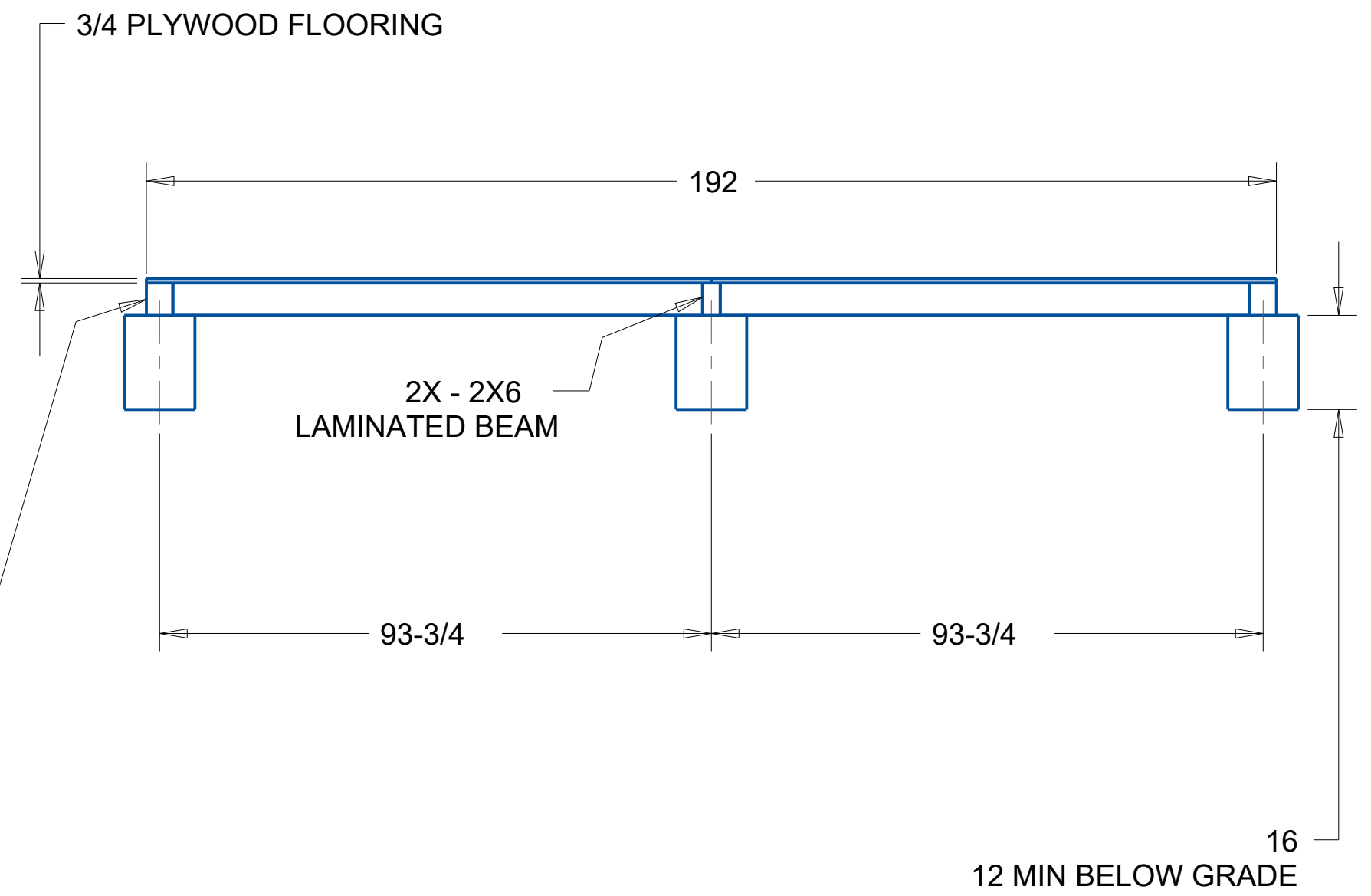
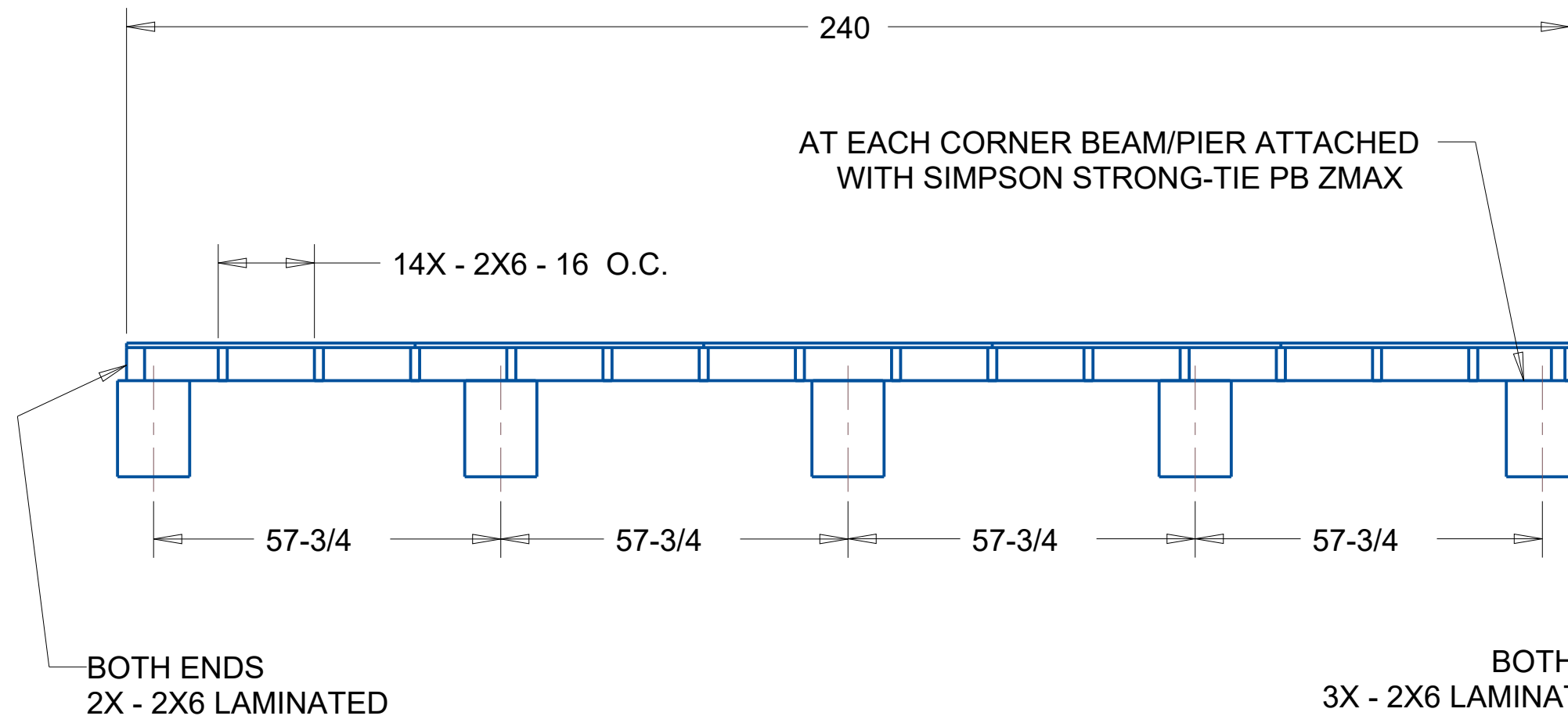

CORY WYAND (HOMEOWNER) - 20 BLAIRWOOD DRIVE

TITLE

16'X20' GARDEN SHED WITH GABLE PORCH

SIZE	DWG NO	REV
C	WYAND_SHED	A
SCALE: 0.040	UNIT WT: INCHES UNLESS NOTED	SHEET 2 OF 6

TITLE			
16'X20' GARDEN SHED WITH GABLE PORCH			
SIZE		DWG NO	REV
C		WYAND_SHED	A
SCALE: 0.040	UNIT WT: INCHES UNLESS NOTED	SHEET 3 OF 6	

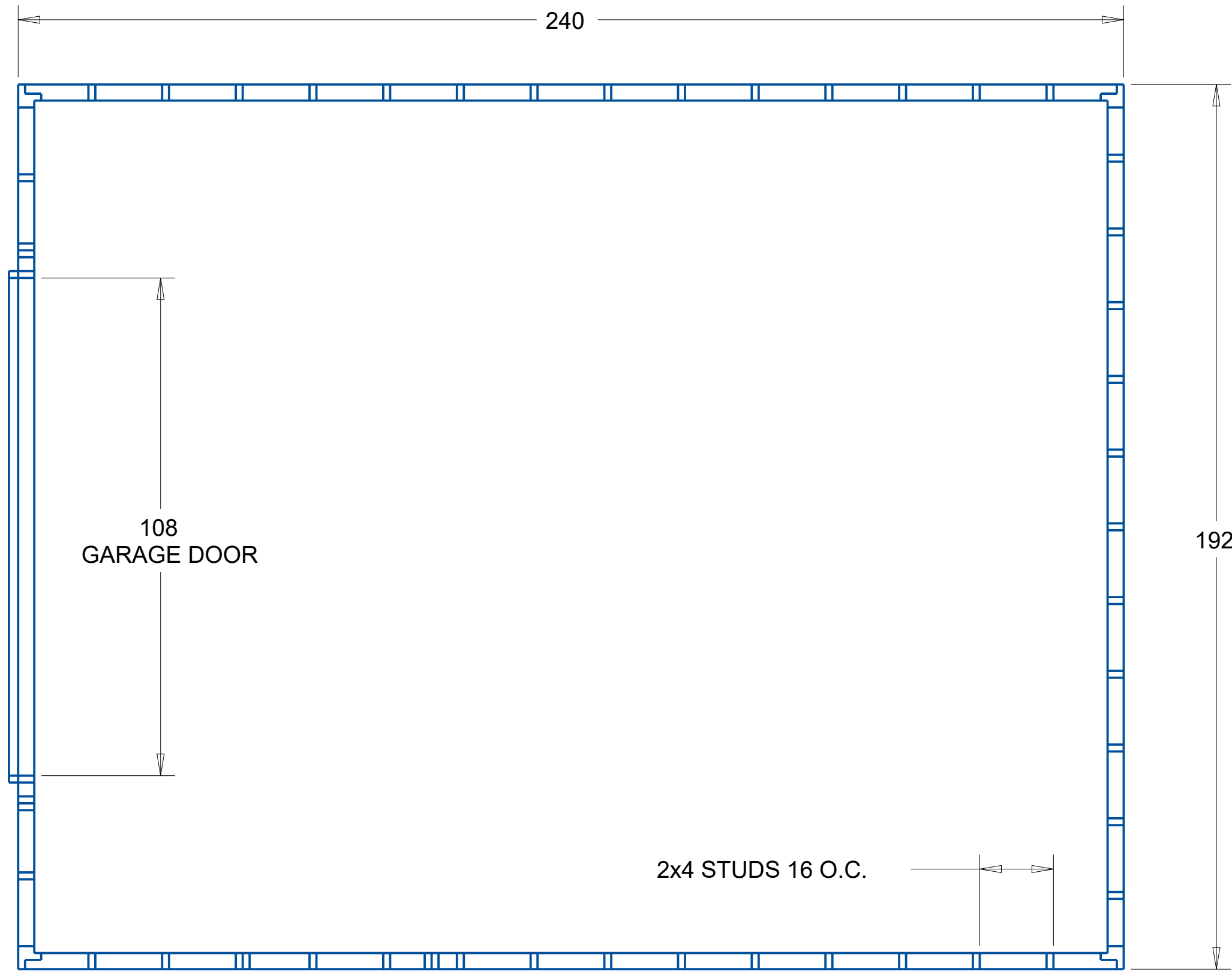

7/16" SHEATHING AND VAPOR BARRIER NOT SHOWN

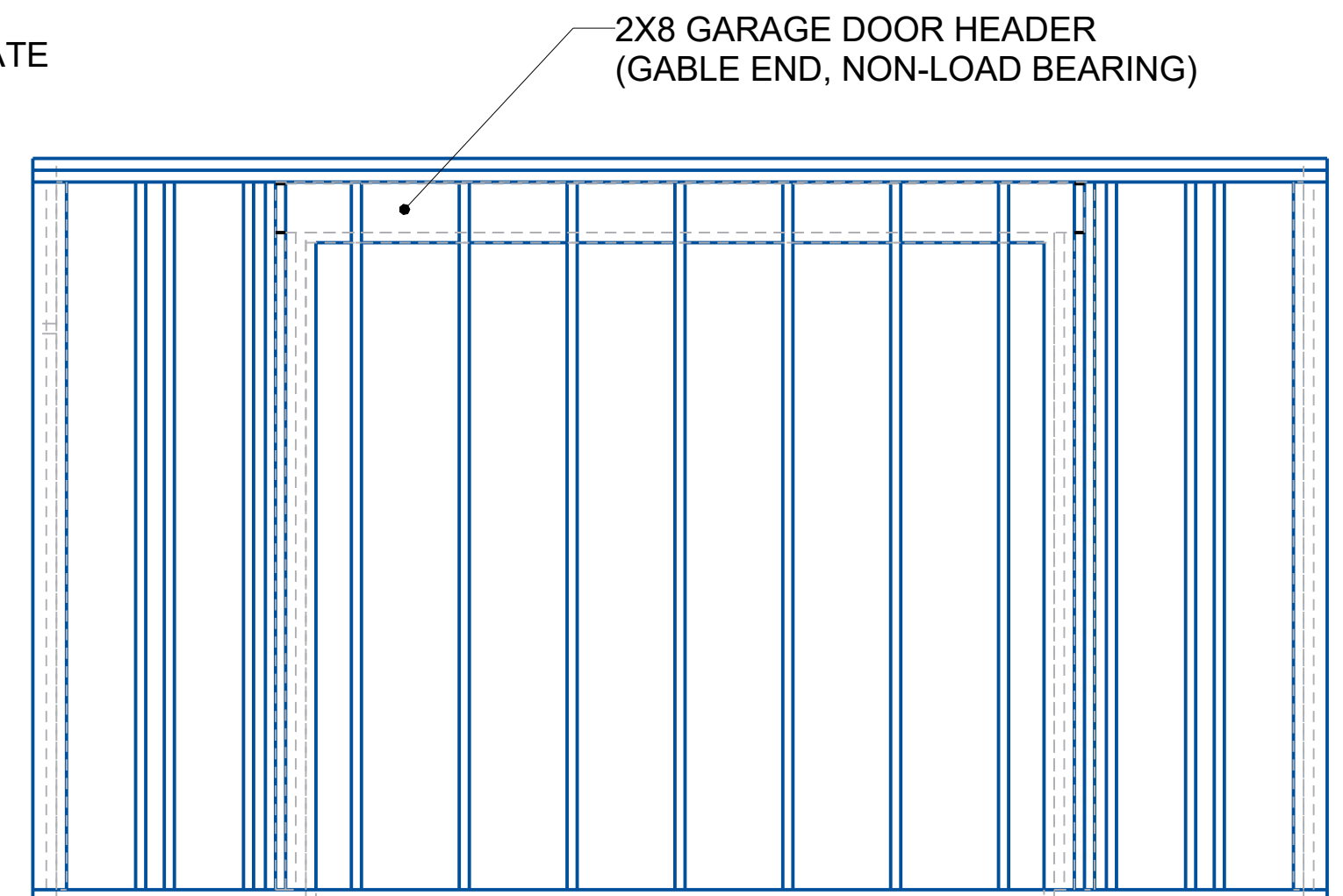
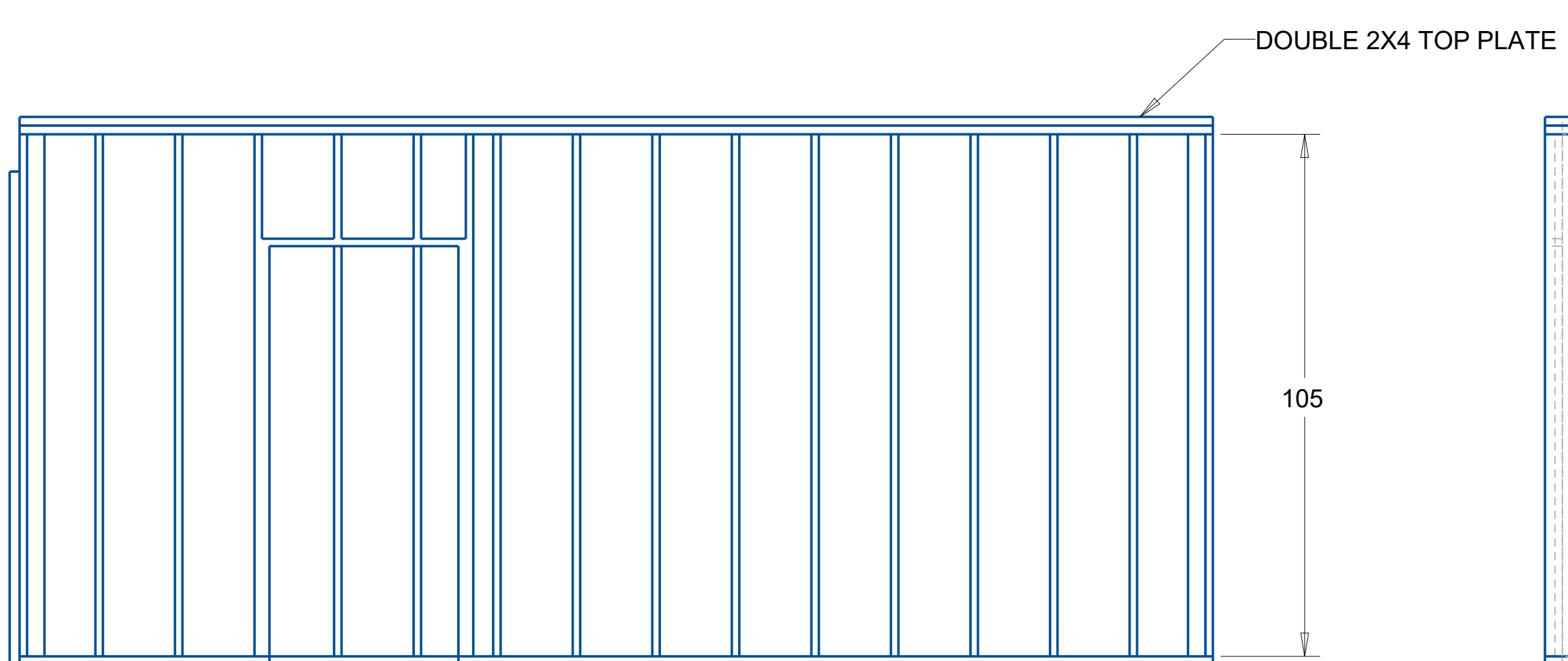

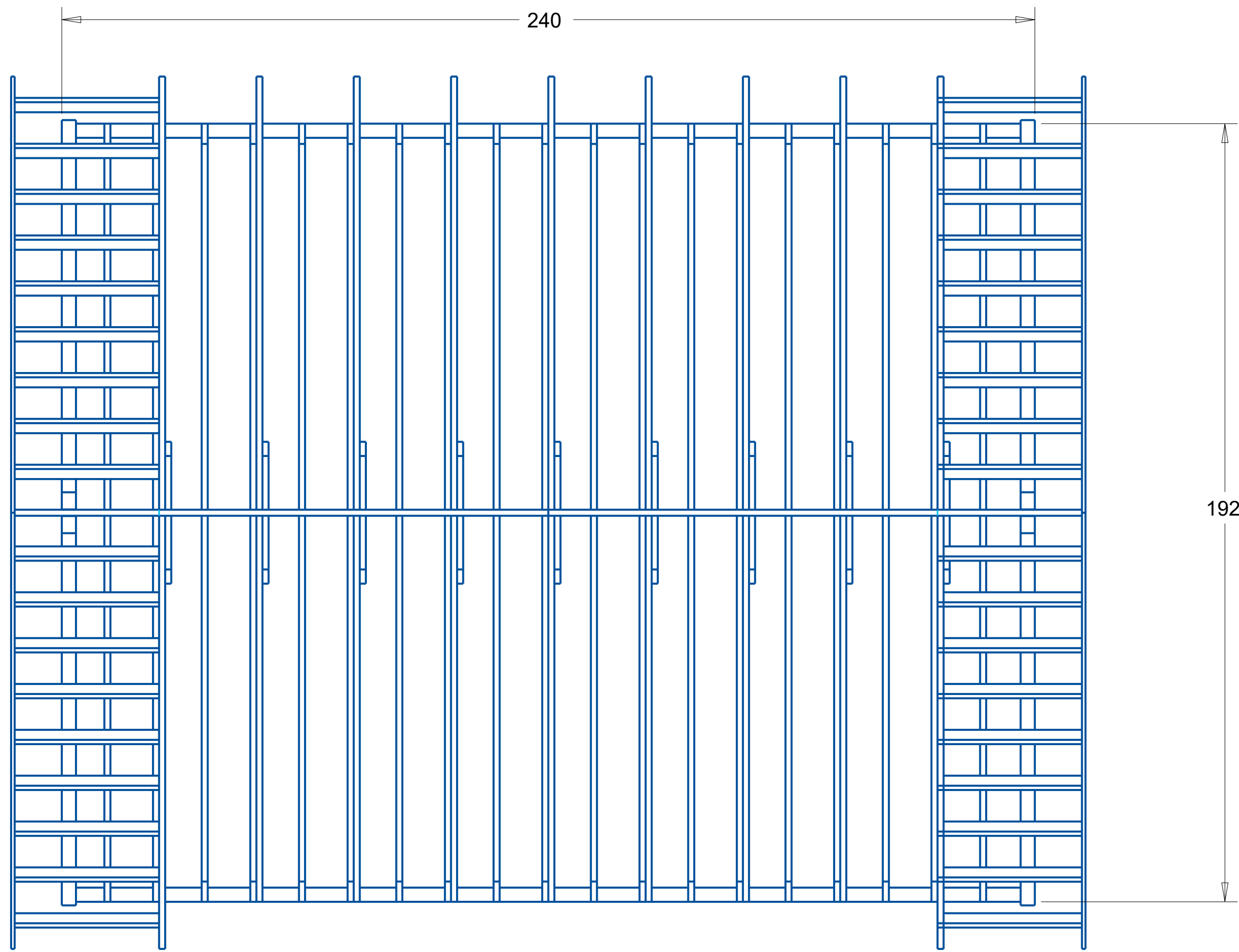

3/4 SHEATHING NOT SHOWN

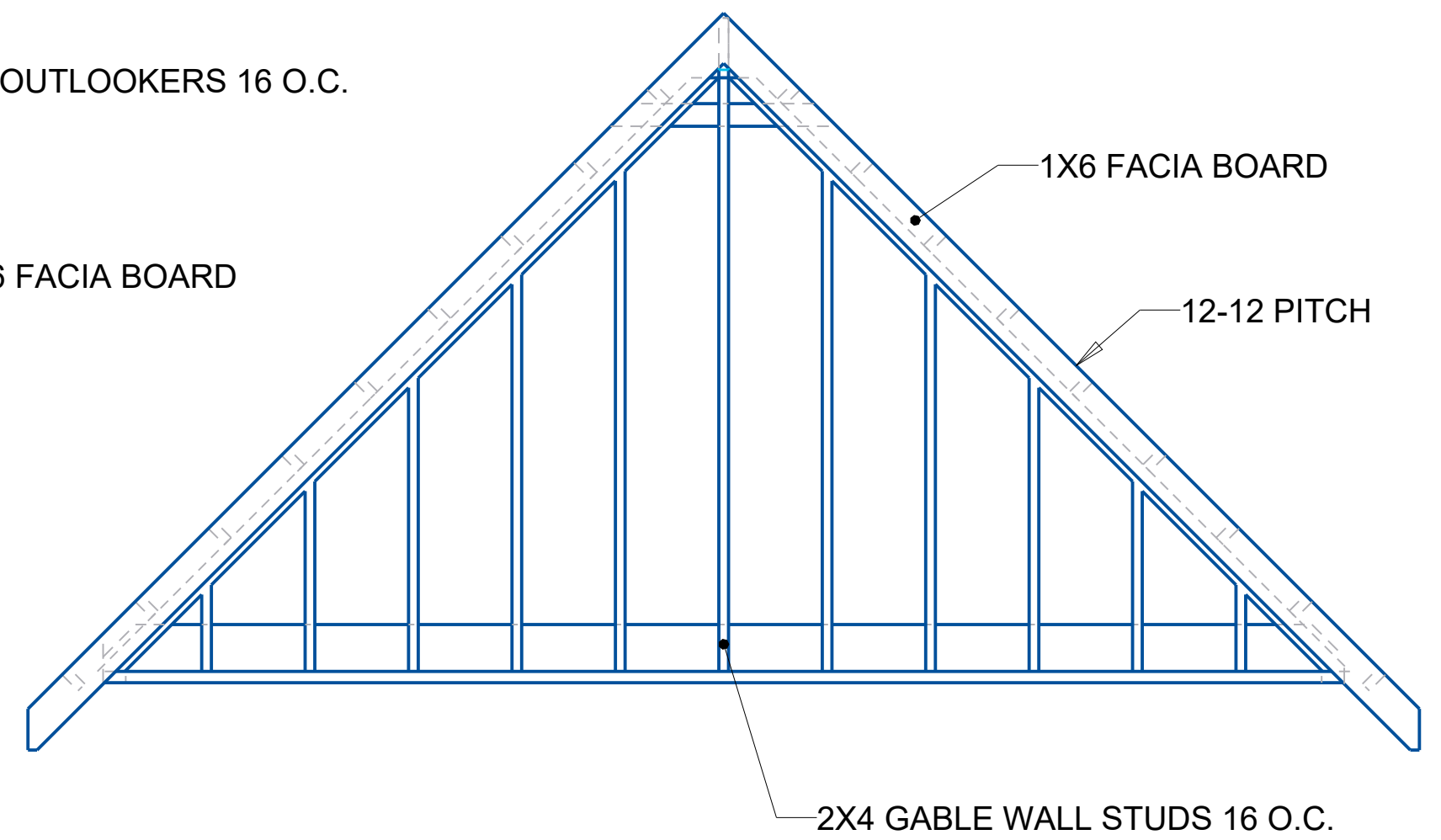
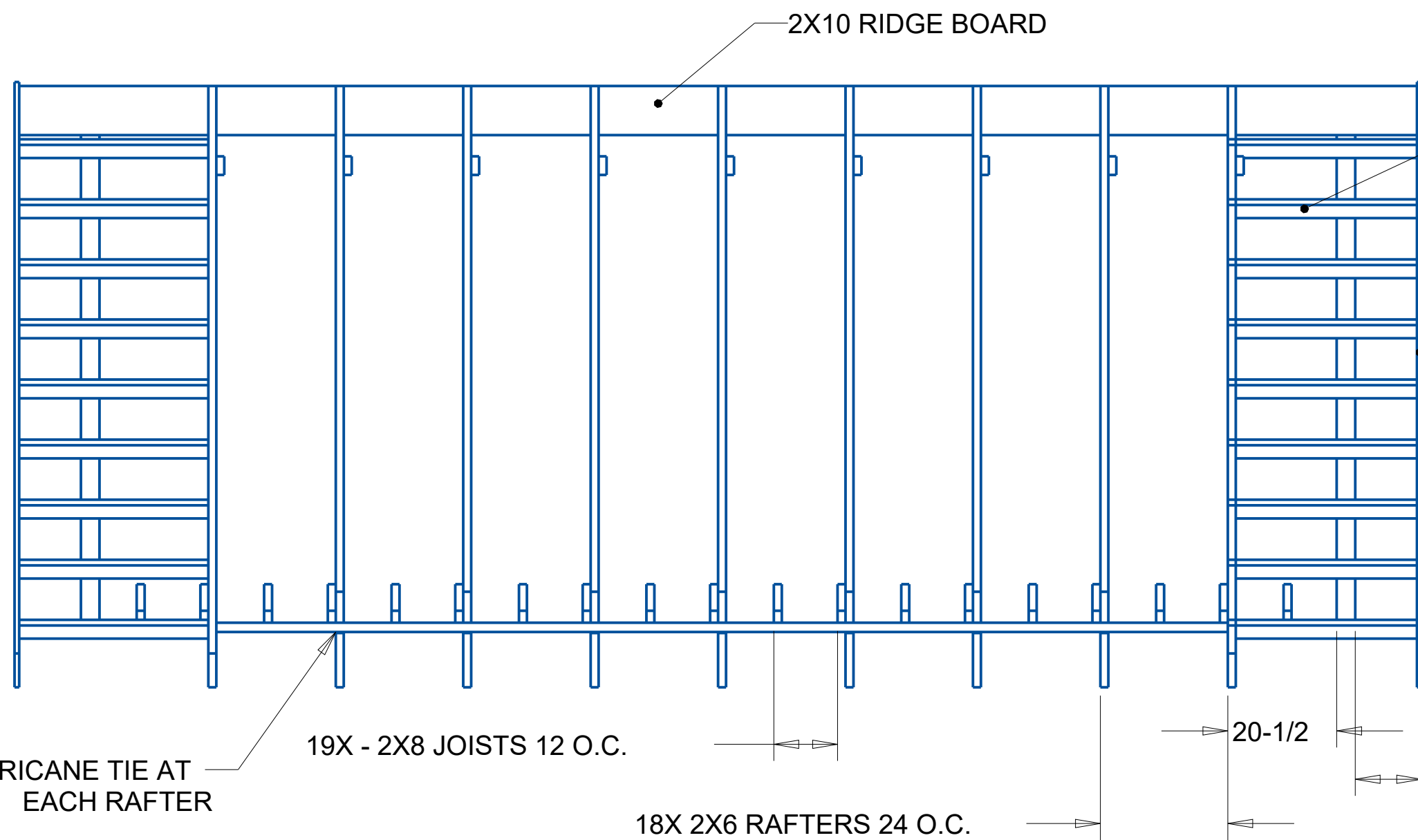

TITLE

16'X20' GARDEN SHED WITH GABLE PORCH

SIZE
C

DWG NO
WYAND_SHED

REV
A

SCALE: 0.030

UNIT WT: INCHES UNLESS NOTED

SHEET 5 OF 6

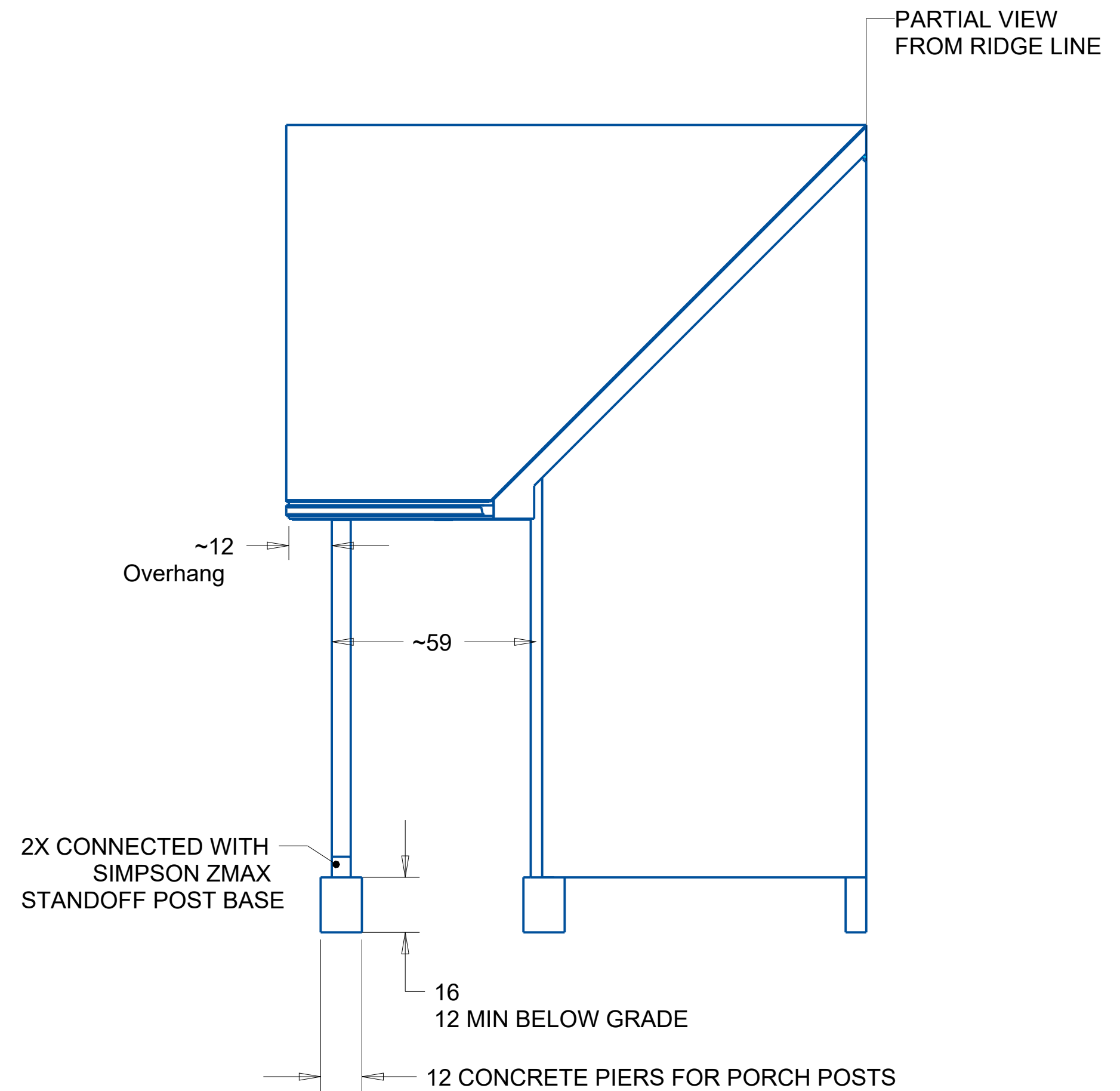
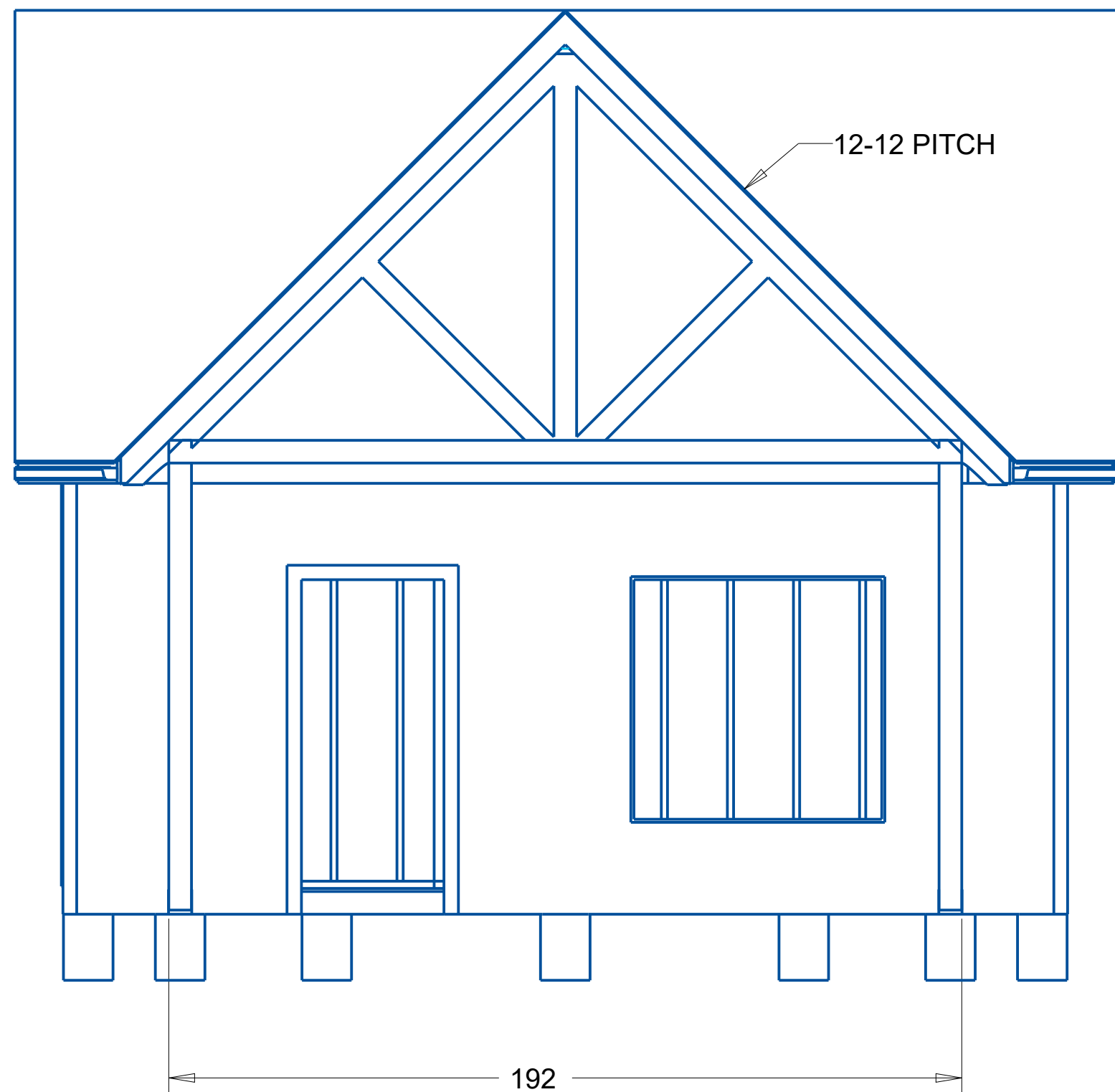
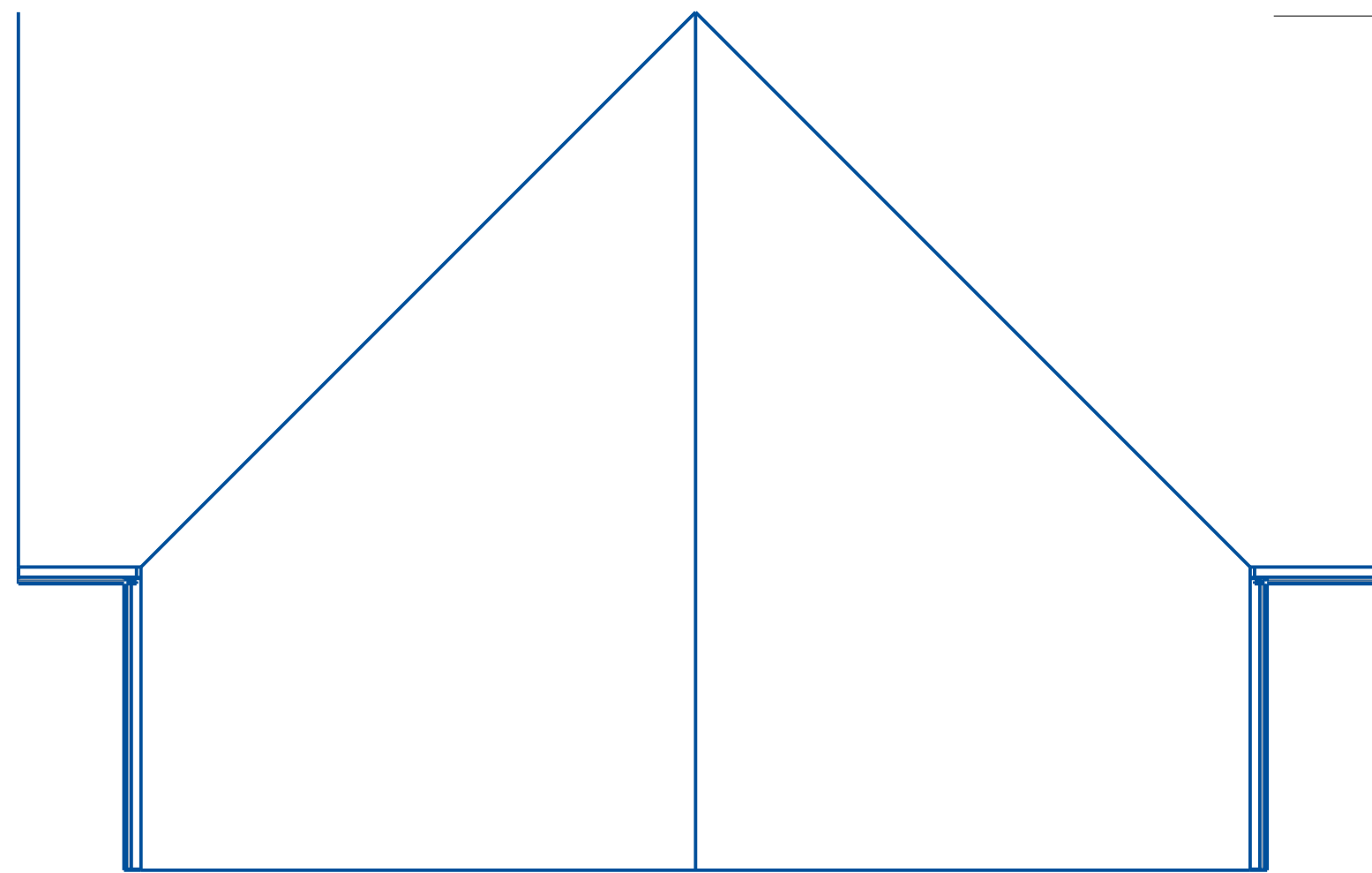

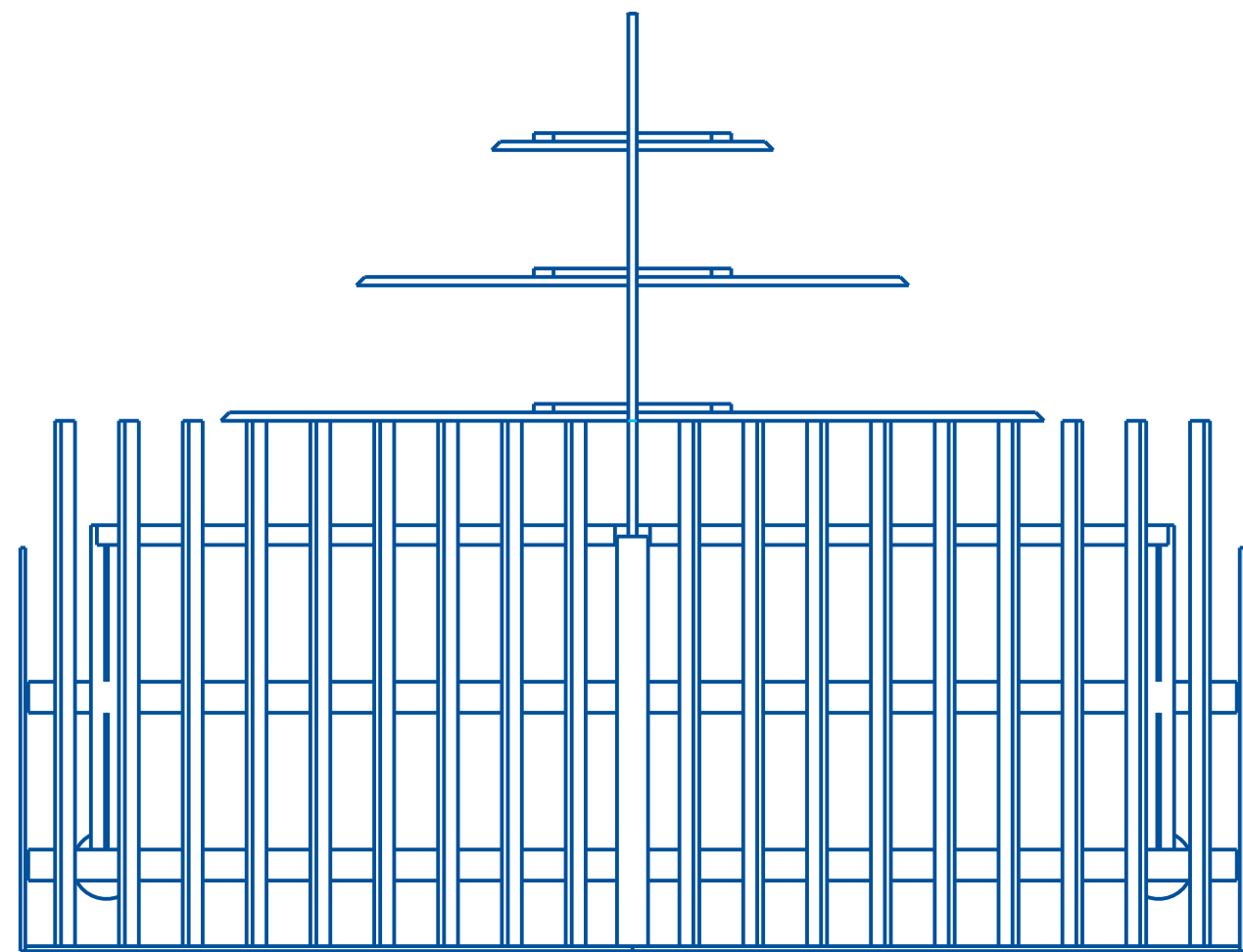

3/4" SHEATHING NOT SHOWN

