

STANDARD CARPORT DETAILS 12 ft to 24 ft SPAN



CAROLINA CARPORTS INC.
P.O. BOX 1263
DOBSON, NC 27017
TOLL FREE 1-800-670-4262
LOCAL 336-367-6400
FAX 336-367-6410

This document is the property of Carolina Carports, Inc. Use of these plans without the permission of Carolina Carports is prohibited.

NOTE: USE \odot 2 1/2" x 2 1/2" 14 Ga.
 \circ 2 1/2" x 2 1/2" 12 Ga.
STEEL TUBE FOR ALL FRAME AND BASE
RAIL MEMBERS UNLESS OTHERWISE SHOWN.

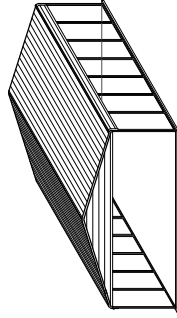

ISOMETRIC

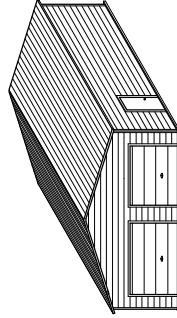

ISOMETRIC

CONCRETE FOUNDATION DESIGN RECOMMENDATIONS:

CONCRETE SLAB AND FOUNDATION ARE BY OTHERS. COORDINATE CONCRETE STRENGTH AND FOUNDATION DEPTH REQUIREMENTS WITH THE LOCAL BUILDING CODE OFFICIALS. THE OWNER IS RESPONSIBLE FOR PROVIDING A SUITABLE FOUNDATION FOR THE PROPOSED STRUCTURE.

CONCRETE SHALL HAVE A MINIMUM SPECIFIED COMPRESSIVE STRENGTH OF 3000 PSI AT 28 DAYS OR AS REQUIRED BY LOCAL BUILDING CODE. THE USE OF HIGHER STRENGTH CONCRETE IS ACCEPTABLE.

COVER OVER REINFORCING STEEL:
MINIMUM CONCRETE OVER REINFORCING BARS SHALL BE 3 INCHES WHERE CONCRETE IS CAST AGAINST AND PERMITTED TO CURVE WITH THE GRADE OR EXPOSED TO THE EARTH OR WEATHER AND 1 1/2" ELSEWHERE.

REINFORCING STEEL:
THE REINFORCING STEEL SHALL BE MINIMUM GRADE 40.

TABLE 1
BOW/RAFTER FRAME, END POST, GROUND ANCHOR AND PANEL FASTENER SPACING SPECIFICATIONS

WIND EXPOSURE CATEGORY	ULTIMATE WIND SPEED (MPH)	NOMINAL WIND SPEED (MPH)	MAXIMUM GROUND SNOW LOAD (PSF)	MAXIMUM POST/RAFTER SPACING (FEET)	AVERAGE FASTENER SPACING ON-CENTERS ALONG RAFTERS OR PURLINS, AND POSTS OR GIRTS (INCHES)	
					METAL PANELS	SPACING
B OR C	105 TO 140	85 TO 112	35	5.0	29 Gauge	8
				4.0	26 Gauge	

NOTES: 1. Specifications applicable to 29 gauge metal panels fastened directly to 12 or 14 gauge steel tube bow frames.
2. Fasteners consist of #12 x 3/4" self-drilling screws with control seal washers.
3. Specifications applicable only for mean roof height of 24 feet or less and roof slopes of 7 to 27 degrees (1.5:12 to 6:12 pitch). Spacing requirements for other roof heights and/or slopes may vary.

TABLE 1 (HIGH WIND REGION)
BOW/RAFTER FRAME, END POST, GROUND ANCHOR AND PANEL FASTENER SPACING SPECIFICATIONS

WIND EXPOSURE CATEGORY	ULTIMATE WIND SPEED (MPH)	NOMINAL WIND SPEED (MPH)	MAXIMUM GROUND SNOW LOAD (PSF)	MAXIMUM POST/RAFTER SPACING (FEET)	AVERAGE FASTENER SPACING ON-CENTERS ALONG RAFTERS OR PURLINS, AND POSTS OR GIRTS (INCHES)	
					METAL PANELS	SPACING
B OR C	141 TO 150	113 TO 121	30	5.0	29 Gauge	8
				4.0	26 Gauge	
B, C OR D	151 TO 170	122 TO 136	20			6

NOTES: 1. Specifications applicable to 29 gauge and 26 gauge metal panels fastened directly to 12 or 14 gauge steel tube bow frames.
2. Fasteners consist of #12 x 3/4" self-drilling screws with control seal washer.
3. Specifications applicable only for mean roof height of 24 feet or less and roof slopes of 7 to 27 degrees (1.5:12 to 6:12 pitch). Spacing requirements for other roof heights and/or slopes may vary.

GENERAL NOTES:

THESE PLANS PERTAIN ONLY TO THE STRUCTURE, INCLUDING MAIN WIND FORCE RESISTING SYSTEM (MWFRS), COMPONENTS AND CLADDING, AND BASE RAIL ANCHORAGE. OTHER DESIGN ISSUES, INCLUDING, BUT NOT LIMITED TO, PLUMBING, ELECTRICAL, INGRESS/EGRESS, PROPERTY SET-BACKS, OR OTHER LOCAL ZONING REQUIREMENTS ARE THE RESPONSIBILITY OF OTHERS. THESE STRUCTURES ARE DESIGNED AS UTILITY/STORAGE BUILDINGS CAPABLE OF SUPPORTING THE DEAD LOAD OF THE STRUCTURE AND APPLICABLE LIVE AND WIND LOADS. IMPROVEMENTS NOT SPECIFICALLY ADDRESSED HEREIN, WHICH EXERT ADDITIONAL LOADS ON THE STRUCTURE SHALL BE AT THE OWNER'S RISK. CAROLINA CARPORTS SHALL NOT BE RESPONSIBLE FOR STRUCTURAL DAMAGE OR FAILURE DUE TO THE APPLICATION OF ADDITIONAL LOADS.

ALL STEEL TUBING SHALL BE 55 KSI STEEL OR BETTER. ALL METAL PANELS SHALL BE 80 KSI STEEL OR BETTER.

FASTEN METAL ROOF AND WALL PANELS TO FRAMING WITH #12" x 3/4" SELF DRILLING FASTENERS WITH CONTROL SEAL WASHERS AT AN AVERAGE SPACING OF 8" FOR 29 GAUGE PANELS AND 6" FOR 26 GAUGE PANELS.

ALL FIELD CONNECTIONS SHALL BE #12 x 3/4" SELF DRILLING FASTENERS (SDF) UNLESS NOTED OTHERWISE.

ALL WELDED CONNECTIONS SHALL BE SHOP WELDED UNLESS NOTED OTHERWISE.

GROUND ANCHOR REQUIREMENTS: INSTALL HELICAL ANCHORS WITHIN 6" OF EACH CORNER POST AND AT A MAXIMUM SPACING OF 26' ALONG THE BASE RAIL. INSTALL GROUND RODS (#4 THREADED REBAR) BETWEEN THE HELICAL ANCHORS AT A MAXIMUM SPACING OF 5' AND A MINIMUM SPACING OF 4' ALONG THE BASE RAIL. HELICAL ANCHORS AND GROUND RODS ARE NOT REQUIRED FOR CONCRETE FOOTING AND/OR CONCRETE SLAB CONSTRUCTION.

CONCRETE EXPANSION ANCHORS SHALL BE ITW RAMSET/REDHEAD TRIBOLT WEDGE ANCHOR, WEJ-IT ANKR-TITE MODEL AT1252, OR SLEEVE ANCHOR MODEL HSA 1260, OR APPROVED EQUAL.

POST/RAFTER BRACING: BRACE ON EVERY POST/RAFTER CONNECTION, EXCEPT FOR END WALLS AND HEADERS.

GALVANIZATION: METAL ACCESSORIES FOR USE IN EXTERIOR WALL CONSTRUCTION AND NOT DIRECTLY EXPOSED TO THE WEATHER SHALL BE GALVANNEAL OR GALVALUME. METAL ACCESSORIES NOT DIRECTLY EXPOSED TO THE WEATHER SHALL BE STAINLESS STEEL OR HOT-DIPPED GALVANIZED.

METAL CARPORT INSTALLATION PLANS AND DETAILS AND

FRAMING AND FASTENER SPECIFICATIONS

CAROLINA CARPORTS, INC.
187 Cardinal Ridge Trail
DOBSON, NORTH CAROLINA 27017

THE OWNER IS RESPONSIBLE FOR OBTAINING A BUILDING PERMIT, IF NEEDED, AND FOR COMPLYING WITH ALL LOCAL BUILDING CODE REQUIREMENTS.

THIS IS TO CERTIFY THAT THE CALCULATIONS AND SPECIFICATIONS HEREIN HAVE BEEN PREPARED BY THE UNDERSIGNED PROFESSIONAL ENGINEER, AND ARE IN ACCORDANCE WITH THE REQUIREMENTS OF THE 2009, 2012, 2015 & 2018 INTERNATIONAL BUILDING CODES AND THE 2018 NORTH CAROLINA BUILDING CODE.

BUILDING CODE INFORMATION	
OCCUPANCY CATEGORY	I
USE GROUP	U
CONSTRUCTION TYPE	5B

IMPORTANCE FACTORS	
WIND Iw	1.0
SNOW Is	0.8
EARTHQUAKE Ie	1.0

DESIGN LOADS	
MIN. DEAD LOAD	5 PSF
MIN. FLOOR LIVE LOAD	100 PSF
MIN. ROOF LIVE LOAD	20 PSF
MIN. GROUND SNOW LOAD	
MIN. ULTIMATE WIND SPEED	SEE TABLE 1
MAX. ULTIMATE WIND SPEED	
EXPOSURE CATEGORY	
SEISMIC RESPONSE COEFFICIENT	0.500

These plans have been provided for the purpose of obtaining a building permit for:

Name: **Holden Bracewell** State: **NC**
Address: **109 Rainmaker St.** Zip: **28356**
City: **Linden**

Use of these plans by anyone else or for any other purpose is prohibited.



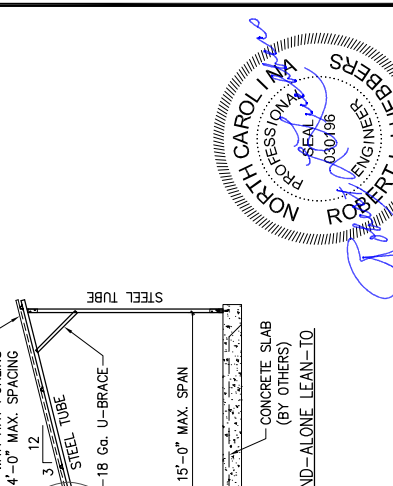
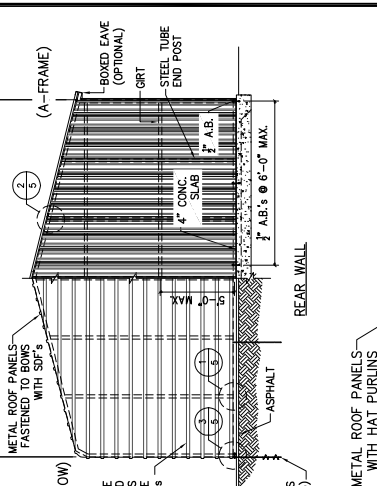
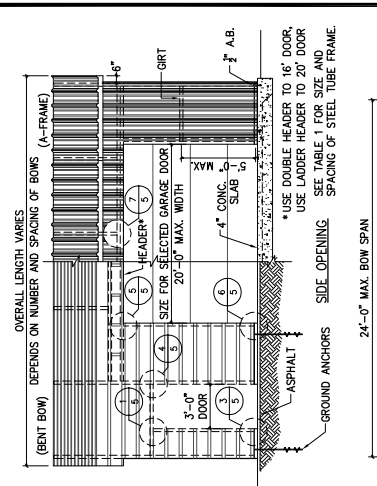
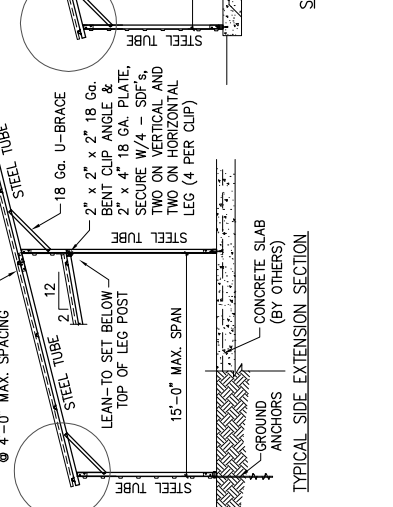
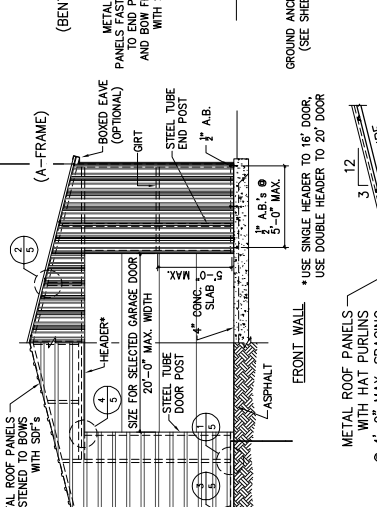
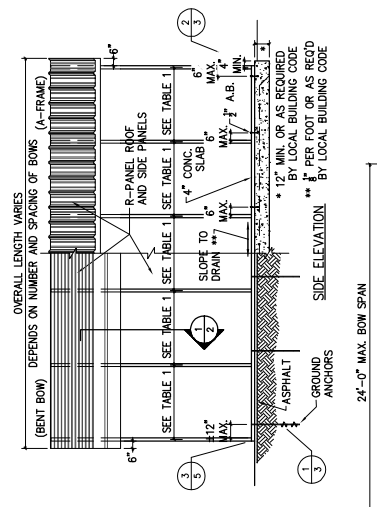
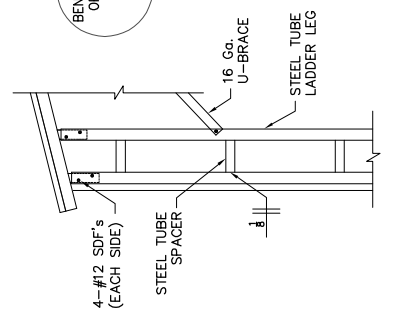
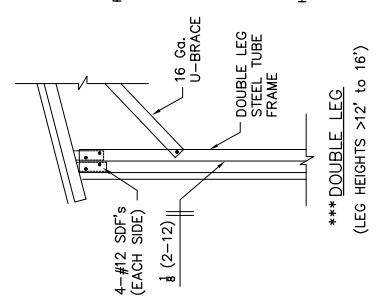
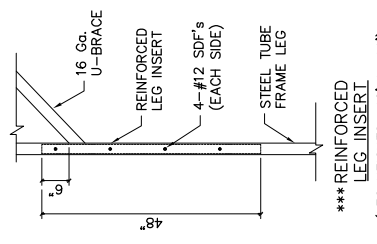
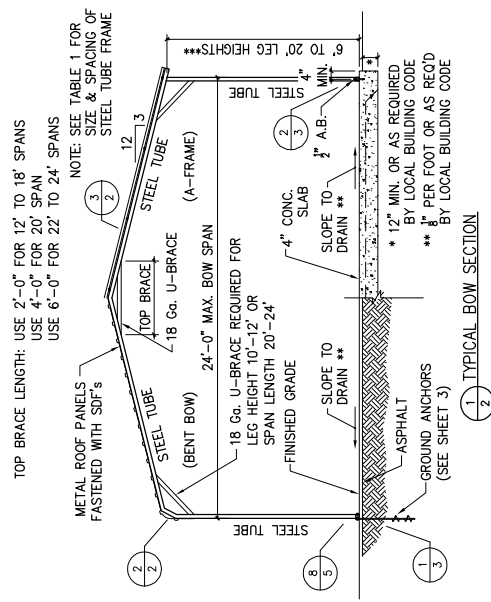

NORTH CAROLINA PROFESSIONAL ENGINEER SEAL NO. 030196

ROBERT L. LILBERS

8/06/2019

SHEET 2 OF 4

DRILL $\frac{5}{8}$ " HOLE THROUGH THE BASE RAIL AND SECURE TO ANCHOR EYE WITH $\frac{1}{2}$ " THROUGH BOLT

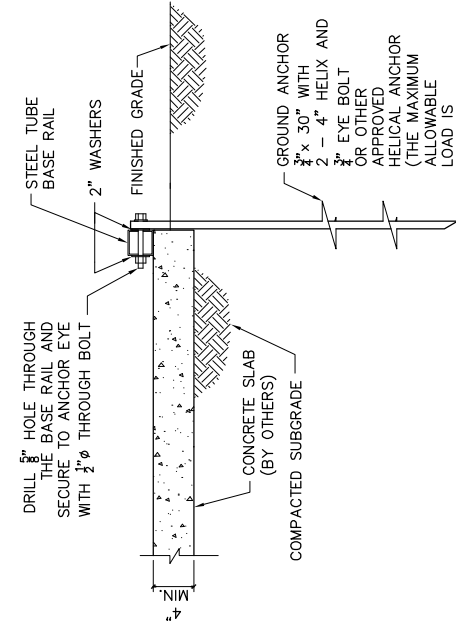

SOIL CLASSIFICATIONS*

- | SOIL CLASS | SOIL DESCRIPTION |
|------------|--|
| 2 | Very dense & or cemented sands, coarse gravel and cobbles, caliche, preloaded silts, and clays. |
| 3 | Medium dense coarse sands, sandy gravels, very stiff silts, and clays. |
| 4 | Loose to medium dense sands, firm to stiff clays and silts alluvial fill and VERY loose to medium dense sands, firm to stiff clays and silts, alluvial fill. |

THE HELICAL ANCHOR SHALL BE APPROVED FOR USE IN SOIL CLASSIFICATIONS 2, 3, AND 4.

* Taken from HUD "Standard for Installation of Mobile Homes"

(1) SOIL BASE RAIL ANCHOR DETAIL

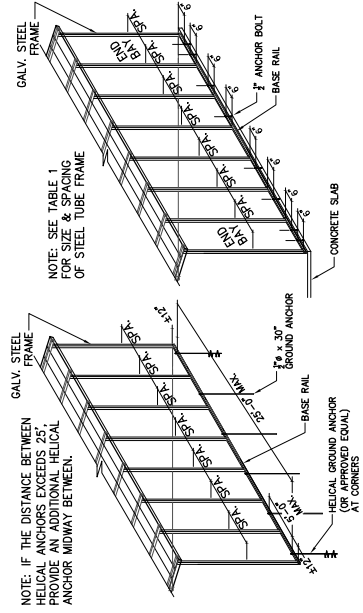

HELICAL GROUND ANCHORS

CONCRETE SHALL HAVE A MINIMUM SPECIFIED COMPRESSIVE STRENGTH (F_c) OF 3000 PSI AT 28 DAYS. THE USE OF HIGHER STRENGTH CONCRETE IS ACCEPTABLE.

MINIMUM CONCRETE COVER OVER REINFORCING BARS SHALL BE 3 INCHES FOR FOUNDATION WHERE CONCRETE IS CAST AGAINST AND PERMANENTLY IN CONTACT WITH THE EARTH OR EXPOSED TO THE WEATHER AND 1 1/2 INCHES ELSEWHERE. REINFORCING BARS EMBEDDED IN GROUTED CELLS SHALL HAVE A MINIMUM CLEAR DISTANCE OF 1/4 INCH FOR FINE GROUT AND 1/2 INCH FOR COARSE GROUT BETWEEN REINFORCING BARS AND ANY FACE OF A CELL. REINFORCING BARS USED IN MASONRY WALLS SHALL HAVE A MASONRY COVER (INCLUDING GROUT) OF NOT LESS THAN 2 INCHES FOR MASONRY UNITS WITH FACE EXPOSED TO EARTH OR WEATHER AND 1 1/2 INCHES ELSEWHERE.

DRILL $\frac{5}{8}$ " HOLE THROUGH THE BASE RAIL AND SECURE TO ANCHOR EYE WITH $\frac{1}{2}$ " THROUGH BOLT

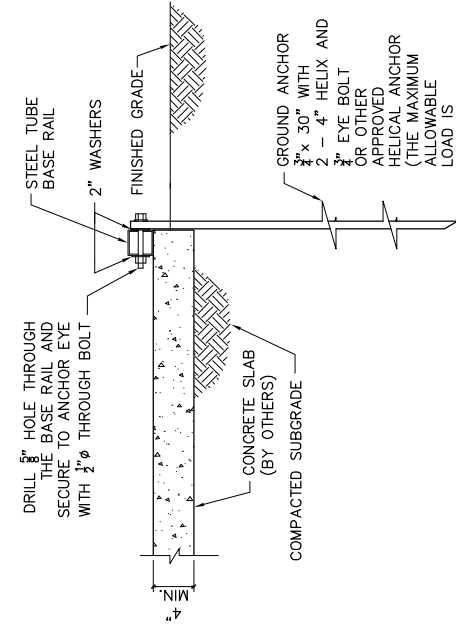

(2) ALTERNATE BASE RAIL ANCHORAGE

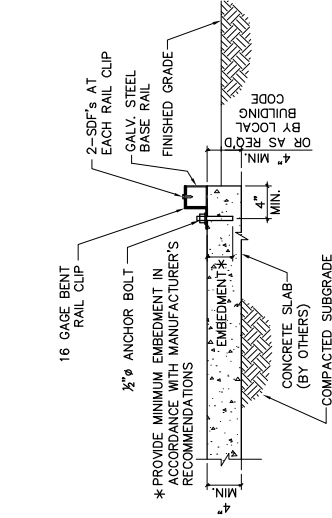

(3) ALTERNATE BASE RAIL ANCHORAGE

THE REINFORCING STEEL SHALL BE MINIMUM GRADE 40 REINFORCEMENT. REINFORCEMENT MAY BE BENT IN THE SHOP OR THE FIELD PROVIDED: ALL REINFORCEMENT IS COLD BENT; THE DIAMETER OF THE BEND MEASURED ON THE INSIDE OF THE BAR IS NOT LESS THAN SIX BAR DIAMETERS; AND REINFORCEMENT PARTIALLY EMBEDDED IS CONCRETE SHALL NOT BE FIELD BENT EXCEPT WHERE BENDING IS NECESSARY TO ALIGN DOWEL BARS WITH A VERTICAL CELL. BARS PARTIALLY EMBEDDED IN CONCRETE MAY BE BENT AT A SLOPE OF NOT MORE THAN 1 INCH OF HORIZONTAL DISPLACEMENT TO 6 INCHES OF VERTICAL BAR LENGTH.

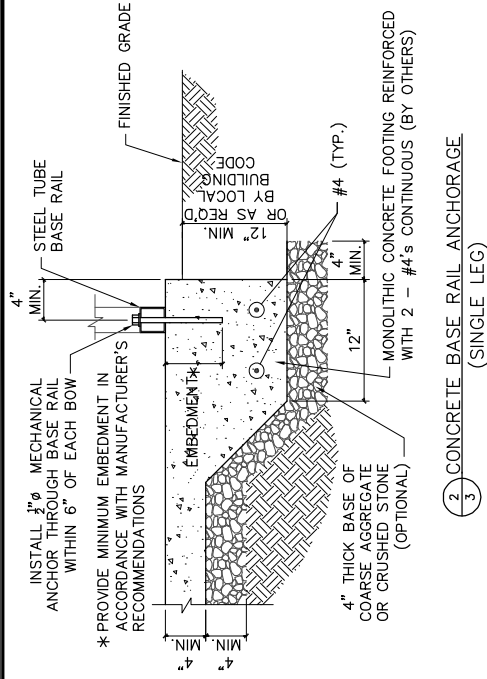

(3) CONCRETE BASE RAIL ANCHORAGE (SINGLE LEG)

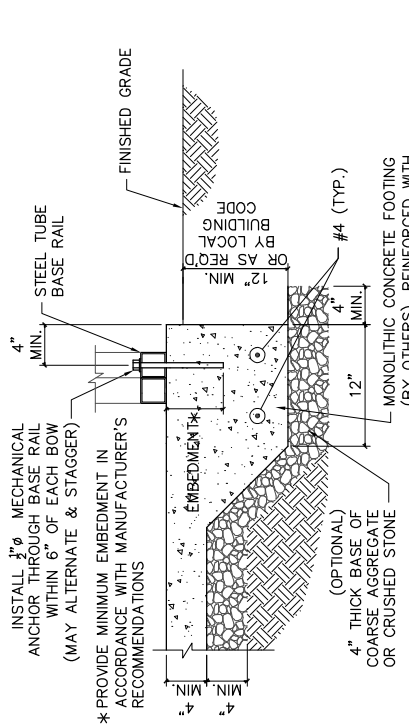

(3) CONCRETE BASE RAIL ANCHORAGE (DOUBLE LEG)

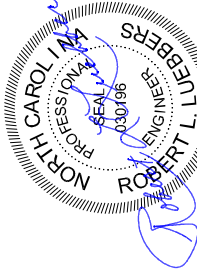

8/06/2019

SHEET 3 OF 4

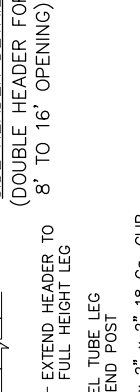
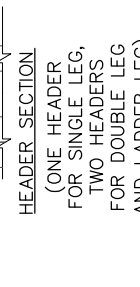
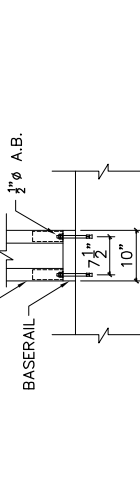
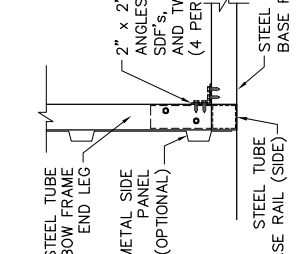
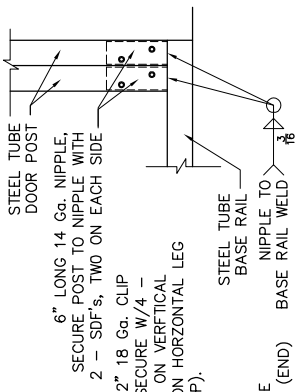
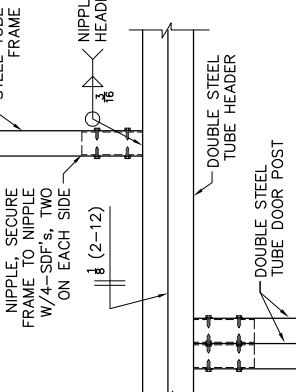
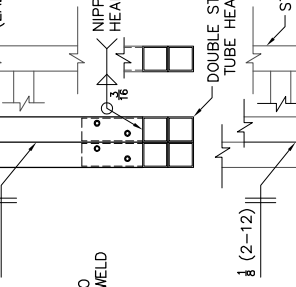
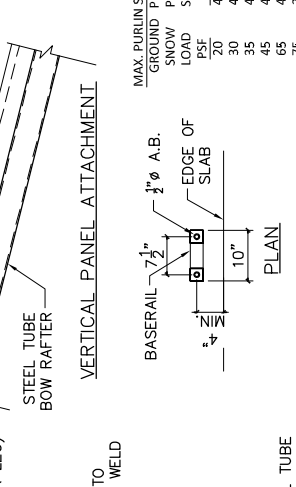
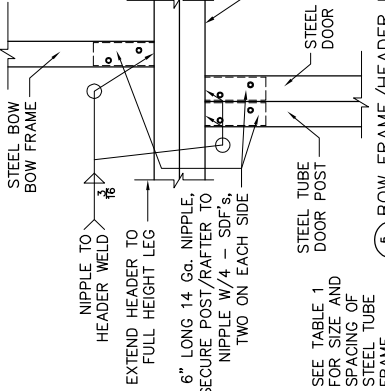
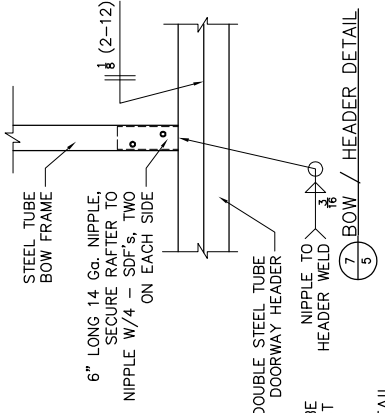
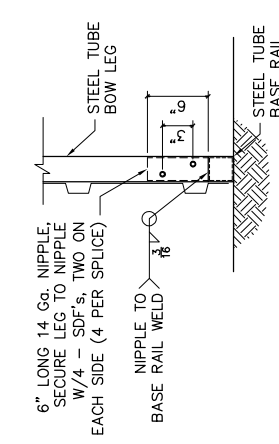
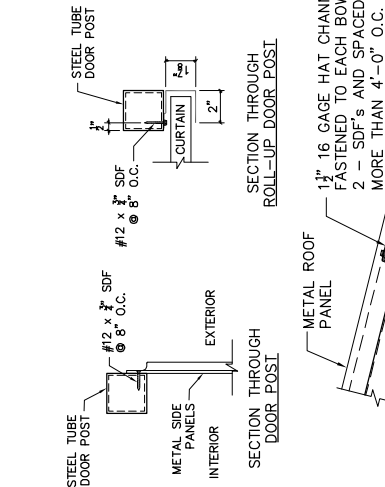

MINIMUM DISTANCE BETWEEN DOORWAYS (12" MINIMUM IS PREFERRED, 10" MINIMUM IS ACCEPTABLE)

U-CHANNEL BRACE B = 2'-0" FOR HEIGHT = 6' TO 8' B = 3'-0" FOR HEIGHT = 8' TO 10' B = 4'-0" FOR LEG HEIGHT > 10'

6" LONG 14 Gg. NIPPLE, SECURE POST TO NIPPLE W/4 - SDF'S, TWO ON EACH SIDE (4 PER SPLICE)

12" LONG 14 Gg. NIPPLE, SECURE RAFTER TO NIPPLE W/4 - SDF'S, TWO ON EACH SIDE (4 PER SPLICE)

STEEL TUBE BOW RAFTER NIPPLE TO BOW RAFTER WELD

STEEL TUBE BOW POST

STEEL TUBE DOOR POST

STEEL TUBE DOOR POST

MAX. PURLIN SPACING	GROUND	PURLIN	SNOW	PANEL	LOAD	SPAN
FT.	PSF	FT.				
20	4.00	30	4.00			
35	4.00	45	4.00			
45	4.00	65	4.00			
75	3.50	90	3.00			

