

Automatic Fire Sprinkler Systems



3101-310 Poplarwood Court - Raleigh, NC 27604

Ph: 919-212-2722 Fax: 919-212-2720

www.regionalfirenc.com

Please Note

The following submittal package is a standard manufacturer submittal. Material Availability, Vendor & Construction Schedule will determine manufacturers used for this project. All manufacturers and equals used are listed on the attached page.

PRODUCT SPECIFICATIONS

For:

HARBOR FREIGHT TOOLS
129 W. Cornelius Harnett Blvd.
Lillington, NC 27546

Submitted by:

Jack Harlow

Automatic Fire Sprinkler Systems



3101-310 Poplarwood Court - Raleigh, NC 27604

Ph: 919-212-2722 Fax: 919-212-2720

www.regionalfirenc.com

PRODUCT DATA MANUFACTURERS

PIPE

ALLIED
BULLMOOSE
WHEATLAND
YOUNGSTOWN
OR EQUAL

GROOVED FITTINGS

ANVIL
GRINNELL
SHUREJOINT
TYCO
VICTAULIC
OR EQUAL

FITTINGS

ANVIL
GRINNELL
SMITH COOPER
STAR
WARD
OR EQUAL

VALVES & DEVICES

GLOBE
GRINNELL
KENNEDY
MILWAUKEE
MULLER
NIBCO
RELIABLE
VICTAULIC
VIKING
OR EQUAL

AIR COMPRESSORS

GENERAL
GAST
JENNY
EMGLO
OR EQUAL

BACKFLOW DEVICES

AMES
CONBRACO
FEBCO
WILKINS
OR EQUAL

HANGERS & SUPPORTS

AFCON
ARGCO
CADDY / ERICO
HILTI
PHD MFG
TOLCO
OR EQUAL

STEEL NIPPLES

MERIT
SEMENOLE
OR EQUAL

FLEXIBLE SPRINKLER PIPE

AQUAFLEX
FLEXHEAD
FLEXDROP
OR EQUAL

SPRINKLER HEADS

GLOBE
RELIABLE
TYCO
VICTAULIC
VIKING

CPVC

BLAZEMASTER
NIBCO
SPEARS
VIKING
OR EQUAL

ELECTRIC SWITCHES

POTTER ELECTRIC
SYSTEM SENSOR
TYCO
VIKING
OR EQUAL

ALL MANUFACTURERS ARE FIRE SUPPRESSION LISTED AND COMPLIANT WITH NFPA STANDARDS



TECHNICAL DATA

EC/QREC ORDINARY HAZARD UPRIGHT SPRINKLER VK570 (K14.0)

The Viking Corporation, 210 N Industrial Park Drive, Hastings MI 49058

Telephone: 269-945-9501 Technical Services: 877-384-5464 Fax: 269-818-1680 Email: techsvcs@vikingcorp.com

Visit the Viking website for the latest edition of this technical data page www.vikinggroupinc.com

1. DESCRIPTION

Viking Standard/Quick Response Extended Coverage Ordinary Hazard (ECOH) Upright Sprinkler VK570 is a thermosensitive glass bulb spray sprinkler with a 14.0 (202 metric*) nominal K-Factor. The sprinkler produces the flows required to meet Ordinary Hazard density requirements at lower pressures than 8.0 or 11.2 (115.2 or 161.4 metric*) K-Factor sprinklers. The glass bulb operating element and special deflector characteristics meet the challenges of quick response extended coverage standards. Viking EC/QREC Ordinary Hazard Sprinklers are available in various finishes and temperature ratings to meet design requirements. The Polyester coatings can be used in decorative applications where colors are desired. In addition, the ENT coating has been investigated for installation in corrosive environments and is listed as indicated in the Approval Charts. The Viking VK570 Sprinkler may be ordered and/or used as an open sprinkler (glass bulb and pip-cap assembly removed) on deluge systems. Refer to Ordering Instructions on the next page.

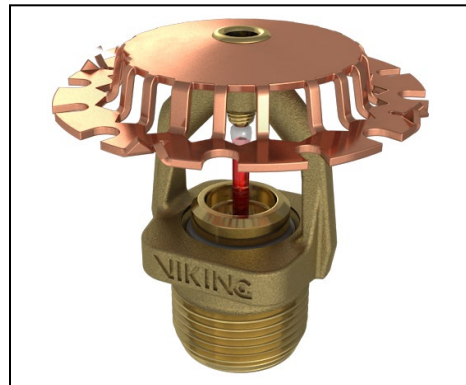

NOTE: As of May 2018 all logos have been removed from the wrench boss.

2. LISTINGS AND APPROVALS



cULus Listed: Category VNIV

NYC Approved: MEA 89-92-E, Volume 38

Refer to the Approval Chart and Design Criteria for cULus Listing requirements that must be followed.



WARNING: Cancer and Reproductive Harm-
www.P65Warnings.ca.gov

3. TECHNICAL DATA

Specifications:

Available since 2007.

Minimum Operating Pressure: Refer to the Approval Charts.

Maximum Working Pressure: 175 psi (12 bar). Factory tested hydrostatically to 500 psi (34.5 bar).

Thread size: 3/4" (20 mm) NPT

Nominal K-Factor: 14.0 U.S. (202 metric*)

* Metric K-factor measurement shown is in Bar. When pressure is measured in kPa, divide the metric K-factor shown by 10.0.

Glass-bulb fluid temperature rated to -65 °F (-55 °C)

Overall Length: 2-7/16" (62 mm)

Material Standards:

Sprinkler Frame: Brass UNS-C84400

Deflector: Phosphor Bronze UNS-C51000

Bulb: Glass, nominal 3 mm diameter

Pip Cap: Brass UNS-C31400 or UNS-C31600

Compression Screw: Brass UNS-C36000

Belleville Spring Sealing Assembly: Nickel Alloy, coated on both sides with PTFE Tape

For ENT coated Sprinklers: Belleville Spring - Exposed, Screw and Pipcap - ENT plated.

For Polyester Coated Sprinklers: Belleville Spring-Exposed

Ordering Information: (Also refer to the current Viking price list.)

Order EC/QREC Ordinary Hazard Upright Sprinkler VK570 by first adding the appropriate suffix for the sprinkler finish and then the appropriate suffix for the temperature rating to the sprinkler base part number.

Finish Suffix: Brass = A, Chrome = F, White Polyester = M-/W, Black Polyester = M-/B, and ENT = JN

Temperature Suffix (°F/°C): 155°/68° = B, 175°/79° = D, 200°/93° = E, and 286°/141° = G, OPEN = Z (PTFE only).

For example, sprinkler VK570 with a Brass finish and a 155 °F/68 °C temperature rating = Part No. 13840AB.

Available Finishes And Temperature Ratings: Refer to Table 1.

Accessories: (Also refer to the Viking website.)

Sprinkler Wrenches:

A. Standard Wrench: Part No. 07297W/B (available since 1991)

Sprinkler Cabinets:

A. Six-head capacity: Part No. 01724A (available since 1971) B. Twelve-head capacity: Part No. 01725A (available since 1971)



TECHNICAL DATA

EC/QREC ORDINARY HAZARD UPRIGHT SPRINKLER VK570 (K14.0)

The Viking Corporation, 210 N Industrial Park Drive, Hastings MI 49058

Telephone: 269-945-9501 Technical Services: 877-384-5464 Fax: 269-818-1680 Email: techsvcs@vikingcorp.com

Visit the Viking website for the latest edition of this technical data page www.vikinggroupinc.com

4. INSTALLATION

Refer to appropriate NFPA Installation Standards.

5. OPERATION

During fire conditions, when the temperature around the sprinkler reaches its operating temperature, the heat-sensitive liquid in the glass bulb expands, causing the bulb to shatter, releasing the pip cap and sealing spring assembly. Water flowing through the sprinkler orifice strikes the sprinkler deflector, forming a uniform spray pattern to extinguish or control the fire.

6. INSPECTIONS, TESTS AND MAINTENANCE

Refer to NFPA 25 for Inspection, Testing and Maintenance requirements.

7. AVAILABILITY

The Viking Model VK570 Sprinkler is available through a network of domestic and international distributors. See The Viking Corporation web site for the closest distributor or contact The Viking Corporation.

8. GUARANTEE

For details of warranty, refer to Viking's current list price schedule or contact Viking directly.

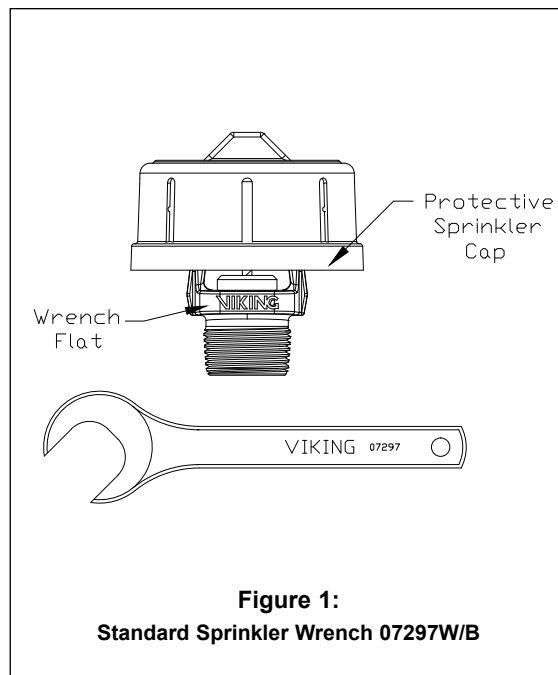



TECHNICAL DATA

**EC/QREC ORDINARY
HAZARD UPRIGHT
SPRINKLER VK570 (K14.0)**

The Viking Corporation, 210 N Industrial Park Drive, Hastings MI 49058
 Telephone: 269-945-9501 Technical Services: 877-384-5464 Fax: 269-818-1680 Email: techsvcs@vikingcorp.com
 Visit the Viking website for the latest edition of this technical data page www.vikinggroupinc.com

TABLE 1: AVAILABLE SPRINKLER TEMPERATURE RATINGS AND FINISHES

Sprinkler Temperature Classification	Sprinkler Nominal Temperature Rating ¹	Maximum Ambient Ceiling Temperature ²	Bulb Color
Ordinary	155 °F (68 °C)	100 °F (38 °C)	Red
Intermediate	175 °F (79 °C)	150 °F (65 °C)	Yellow
Intermediate	200 °F (93 °C)	150 °F (65 °C)	Green
High	286 °F (141 °C)	225 °F (107 °C)	Blue

Available Sprinkler Finishes: Brass, Chrome, White Polyester, Black Polyester, and ENT³

Corrosion Resistant Sprinkler Finishes: ENT³

Footnotes

¹ The sprinkler temperature rating is stamped on the deflector.

² Based on NFPA-13. Other limits may apply, depending on fire loading, sprinkler location, and other requirements of the Authority Having Jurisdiction. Refer to specific installation standards.

³ The corrosion-resistant coatings have passed the standard corrosion test required by the approving agencies indicated in the Approval Charts. These tests cannot and do not represent all possible corrosive environments. Prior to installation, verify through the end-user that the coatings are compatible with or suitable for the proposed environment. For automatic sprinklers, the coatings indicated are applied to the exposed exterior surfaces only. Note that the spring is exposed on sprinklers with Polyester and ENT. For ENT coated automatic sprinklers, the waterway is coated.

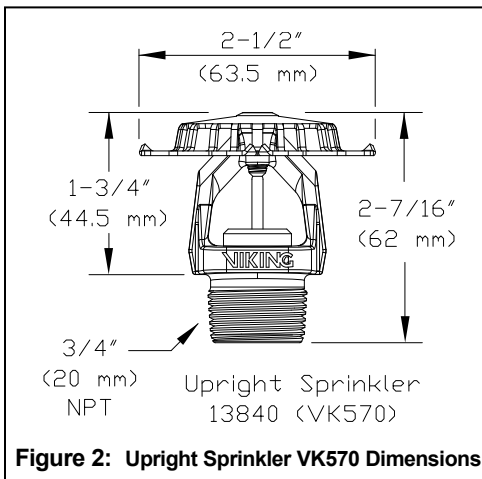



TECHNICAL DATA

EC/QREC ORDINARY HAZARD UPRIGHT SPRINKLER VK570 (K14.0)

The Viking Corporation, 210 N Industrial Park Drive, Hastings MI 49058

Telephone: 269-945-9501 Technical Services: 877-384-5464 Fax: 269-818-1680 Email: techsvcs@vikingcorp.com

Visit the Viking website for the latest edition of this technical data page www.vikinggroupinc.com

Approval Chart 1 (UL)													
Standard/Quick Response Extended Coverage Upright Ordinary Hazard Sprinkler VK570 (K14.0)													
<table border="1" style="border-collapse: collapse;"> <tr> <td style="padding: 2px;">Temperature</td> <td style="padding: 2px;">KEY</td> </tr> <tr> <td style="padding: 2px;">Finish</td> <td style="padding: 2px;"></td> </tr> <tr> <td style="padding: 2px;">A1X ← Escutcheon (if applicable)</td> <td style="padding: 2px;"></td> </tr> </table>								Temperature	KEY	Finish		A1X ← Escutcheon (if applicable)	
Temperature	KEY												
Finish													
A1X ← Escutcheon (if applicable)													
Sprinkler Base Part Number ¹	SIN	NPT Thread Size		Nominal K-Factor		Maximum Water Working Pressure	Overall Length						
		Inches	mm	U.S.	metric ²		Inches	mm					
13840 Upright	VK570	3/4	20	14.0	202	175 psi (12 bar)	2-7/16	62					
Maximum Sprinkler Spacing L x W ⁵	Maximum Area per Sprinkler	Minimum Water Supply Requirements (cULus only)					cULus/NYC Listings ^{3,4,7} (See Design Criteria.)						
		Ordinary Hazard Group I			Ordinary Hazard Group II								
		Flow / Pressure			Flow / Pressure								
Standard Response							Upright VK570						
16 ft. x 16 ft. (4.9 m x 4.9 m)	256 ft ² (23.8 m ²)	39 gpm @ 7.8 psi (147.6 l/min @ 0.54 bar)			51 gpm @ 13.3 psi (193.1 l/min @ 0.92 bar)		A1						
18 ft. x 18 ft. (5.5 m x 5.5 m)	324 ft ² (30.1 m ²)	49 gpm @ 12.3 psi (185.5 l/min @ 0.85 bar)			65 gpm @ 21.6 psi (246.1 l/min @ 1.49 bar)		A1						
20 ft. x 20 ft. (6.1 m x 6.1 m)	400 ft ² (37.2 m ²)	60 gpm @ 18.4 psi (227.1 l/min @ 1.27 bar)			80 gpm @ 32.7 psi (302.8 l/min @ 2.25 bar)		A1						
Quick Response ⁶													
12 ft. x 12 ft. (3.7 m x 3.7 m)	144 ft ² (13.4 m ²)	39 gpm @ 7.8 psi (147.6 l/min @ 0.54 bar)			39 gpm @ 7.8 psi (147.6 l/min @ 0.54 bar)		A1						
14 ft. x 14 ft. (4.3 m x 4.3 m)	196 ft ² (18.2 m ²)	39 gpm @ 7.8 psi (147.6 l/min @ 0.54 bar)			39 gpm @ 7.8 psi (147.6 l/min @ 0.54 bar)		A1						
Approved Temperature Ratings		Approved Finishes											
A - 155 °F (68 °C), 175 °F (79 °C), 200 °F (93 °C), and 286 °F (141 °C) ⁶		1 - Brass, Chrome, White Polyester, Black Polyester, and ENT ⁸											
Footnotes													
¹ Part number shown is the base part number. For complete part number, refer to current Viking price list schedule. ² Metric K-factor measurement shown is when pressure is measured in Bar. When pressure is measured in kPa, divide the metric K-factor shown by 10.0. ³ This chart shows listings and approvals available at time of printing. Other approvals may be in process. Check with the manufacturer for any additional approvals. ⁴ cULus Listed for use in the U.S. and Canada. ⁵ To determine "Minimum Water Supply Requirement" for areas of coverage where length and width of actual sprinkler spacing are not equal, select the "Maximum Sprinkler Spacing" from the chart that is equal to or greater than the larger of the actual spacing (length or width) dimensions used. Example: When using 10 ft 6 in x 13 ft (3.2 m x 4 m) sprinkler spacing, provide the "Minimum Water Supply Requirement" listed in the chart for 14 ft x 14 ft (4.3 m x 4.3 m) spacing. For areas of coverage smaller than shown, use the "Minimum Water Supply Requirement" in the appropriate hazard group for the next larger area listed. The distance from sprinklers to walls shall not exceed one-half the "Maximum Sprinkler Spacing" listed for the "Minimum Water Supply Requirement" used. ⁶ For Sprinkler VK570 with High Temperature 286 °F rating, UL restricts the QR listing to their use in Ordinary Hazard occupancies to the high temperature zones within a building only. VK570 quick response sprinklers with this temperature rating cannot be used throughout the property. ⁷ Accepted for use, City of New York Department of Buildings, MEA Number 89-92-E, Vol. 38. ⁸ cULus Listed as corrosion resistant.													



TECHNICAL DATA

EC/QREC ORDINARY HAZARD UPRIGHT SPRINKLER VK570 (K14.0)

The Viking Corporation, 210 N Industrial Park Drive, Hastings MI 49058

Telephone: 269-945-9501 Technical Services: 877-384-5464 Fax: 269-818-1680 Email: techsvcs@vikingcorp.com

Visit the Viking website for the latest edition of this technical data page www.vikinggroupinc.com

DESIGN CRITERIA - UL

(Also refer to Approval Chart 1)

cULus Listing Requirements: ECOH Upright Sprinkler VK570 is cULus Listed as Standard and Quick Response for installation in accordance with the latest edition of NFPA 13 for extended coverage upright sprinklers as indicated below:

- The minimum water supplies and maximum areas of coverage shown in Approval Chart 1 are designed to provide the following design densities: 0.15 gpm/ft² (6.1 mm/min) for Ordinary-Hazard Group I densities; 0.2 gpm/ft.² (8.1 mm/min) for Ordinary-Hazard Group II densities.
- The sprinkler installation rules contained in NFPA 13 for extended coverage upright spray sprinklers must be followed with the exception that cULus Listing requires the spacing between Viking ECOH Upright Sprinklers to be a minimum of 9 ft. (2.75 m) to prevent cold soldering.
- Viking ECOH Upright Sprinklers are cULus Listed for use in unobstructed construction, and noncombustible obstructed construction consisting of solid steel and/or concrete beams as defined in the latest edition of NFPA 13.
- Ceiling slope not to exceed 2/12 (9.5°).

Also, Viking ECOH Upright Sprinkler VK570 is specifically cULus Listed for:

- For non-combustible obstructed construction within trusses or bar joists having non-combustible web members greater than 1" (25.4 mm) when applying the 4 times obstruction criteria rule as defined in NFPA 13 under "Obstructions to Sprinkler Discharge Pattern Development".
- For installation under concrete tees when installed as follows:
 1. The stems of the concrete tee construction must be spaced between 3 ft (0.9 m) and 7 ft-6 in (2.3 m) on center. The depth of the concrete tees must not exceed 30 in (762 mm). The maximum permitted concrete tee length is 32 ft (9.8 m). However, where the concrete tee length exceeds 32 ft (9.8 m), non-combustible baffles, equal in height to the depth of the tees, can be installed so that the space between the tees does not exceed 32 ft (9.8 m).
 2. The sprinkler deflector is to be located in a horizontal plane at or above 1" (25.4 mm) below the bottom of the concrete tee stems.
 3. When the sprinkler deflector is located higher than a horizontal plane 1" (25.4 mm) beneath the bottom of the concrete tee stems, the obstruction to sprinkler discharge criteria requirements of NFPA 13 for extended coverage upright sprinklers applies.

IMPORTANT: Always refer to Bulletin Form No. F_091699 - Care and Handling of Sprinklers. Also refer to Form No. F_080614 for general care, installation, and maintenance information. Viking sprinklers are to be installed in accordance with the latest edition of Viking technical data, the appropriate standards of NFPA, LPCB, APSAD, VdS or other similar organizations, and also with the provisions of governmental codes, ordinances, and standards, whenever applicable.



BULLETIN

CARE AND HANDLING
OF SPRINKLERS

The Viking Corporation, 210 N Industrial Park Drive, Hastings MI 49058
 Telephone: 269-945-9501 Technical Services: 877-384-5464 Fax: 269-818-1680 Email: techsvcs@vikingcorp.com

SPRINKLERS ARE FRAGILE - HANDLE WITH CARE!

General Handling and Storage:

- Store sprinklers in a cool, dry place.
- Protect sprinklers during storage, transport, handling, and after installation.
- Use the original shipping containers. DO NOT place sprinklers loose in boxes, bins, or buckets.
- Keep sprinklers separated at all times. DO NOT allow metal parts to contact sprinkler operating elements.

For Pre-Assembled Drops:

- Protect sprinklers during handling and after installation.
- For recessed assemblies, use the protective sprinkler cap (Viking Part Number 10364).

Sprinklers with Protective Shields or Caps:

- DO NOT remove shields or caps until after sprinkler installation and there no longer is potential for mechanical damage to the sprinkler operating elements.
- **Sprinkler shields or caps MUST be removed BEFORE placing the system in service!**
- Remove the sprinkler shield by carefully pulling it apart where it is snapped together.
- Remove the cap by turning it slightly and pulling it off the sprinkler.

Sprinkler Installation:

- DO NOT use the sprinkler deflector or operating element to start or thread the sprinkler into a fitting.
- **Use only the designated sprinkler head wrench!** Refer to the current sprinkler technical data page to determine the correct wrench for the model of sprinkler used.
- DO NOT install sprinklers onto piping at the floor level.
- Install sprinklers after the piping is in place to prevent mechanical damage.
- DO NOT allow impacts such as hammer blows directly to sprinklers or to fittings, pipe, or couplings in close proximity to sprinklers. Sprinklers can be damaged from direct or indirect impacts.
- DO NOT attempt to remove drywall, paint, etc., from sprinklers.
- **Take care not to over-tighten the sprinkler and/or damage its operating parts!**

Maximum Torque:

1/2" NPT: 14 ft-lbs. (19.0 N-m)

3/4" NPT: 20 ft-lbs. (27.1 N-m)

1" NPT: 30 ft-lbs. (40.7 N-m)



CORRECT
(Original container used)

INCORRECT
(Placed loose in box)

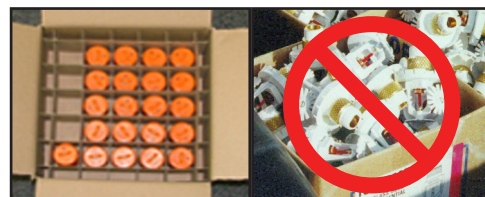

CORRECT
(Protected with caps)

INCORRECT
(Protective caps not used)



CORRECT
(Piping is in place at the ceiling)

INCORRECT
(Sprinkler at floor level)



CORRECT
(Special installation wrenches)

INCORRECT
(Designated wrench not used)



WARNING: Cancer and Reproductive Harm-
www.P65Warnings.ca.gov

! WARNING

Any sprinkler with a loss of liquid from the glass bulb or damage to the fusible element should be destroyed. Never install sprinklers that have been dropped, damaged, or exposed to temperatures exceeding the maximum ambient temperature allowed. Sprinklers that have been painted in the field must be replaced per NFPA 13. Protect sprinklers from paint and paint overspray in accordance with the installation standards. Do not clean sprinklers with soap and water, ammonia, or any other cleaning fluid. Do not use adhesives or solvents on sprinklers or their operating elements.

Refer to the appropriate technical data page and NFPA standards for complete care, handling, installation, and maintenance instructions. For additional product and system information Viking data pages and installation instructions are available on the Viking Web site at www.vikinggroupinc.com.



BULLETIN

CARE AND HANDLING
OF SPRINKLERS

The Viking Corporation, 210 N Industrial Park Drive, Hastings MI 49058
 Telephone: 269-945-9501 Technical Services: 877-384-5464 Fax: 269-818-1680 Email: techsvcs@vikingcorp.com

PROTECTIVE SPRINKLER SHIELDS AND CAPS

General Handling and Storage:

Many Viking sprinklers are available with a plastic protective cap or shield temporarily covering the operating elements. The snap-on shields and caps are factory installed and are intended to help protect the operating elements from mechanical damage during shipping, storage, and installation. NOTE: It is still necessary to follow the care and handling instructions on the appropriate sprinkler technical data sheets* when installing sprinklers with bulb shields or caps.

WHEN TO REMOVE THE SHIELDS AND CAPS:

NOTE: SHIELDS AND CAPS MUST BE REMOVED FROM SPRINKLERS BEFORE PLACING THE SYSTEM IN SERVICE!

Remove the shield or cap from the sprinkler only after checking all of the following:

- The sprinkler has been installed*.
- The wall or ceiling finish work is completed where the sprinkler is installed and there no longer is a potential for mechanical damage to the sprinkler operating elements.

SHIELDS AND CAPS MUST BE REMOVED FROM SPRINKLERS BEFORE PLACING THE SYSTEM IN SERVICE!



Figure 1: Sprinkler shield being removed from a pendent sprinkler.



Figure 2: Sprinkler cap being removed from a pendent sprinkler.



Figure 3: Sprinkler cap being removed from an upright sprinkler.

HOW TO REMOVE SHIELDS AND CAPS:

No tools are necessary to remove the shields or caps from sprinklers. DO NOT use any sharp objects to remove them! **Take care not to cause mechanical damage to sprinklers when removing the shields or caps.** When removing caps from fusible element sprinklers, use care to prevent dislodging ejector springs or damaging fusible elements. NOTE: Squeezing the sprinkler cap excessively could damage sprinkler fusible elements.

- To remove the shield, simply pull the ends of the shield apart where it is snapped together. Refer to Figure 1.
- To remove the cap, turn it slightly and pull it off the sprinkler. Refer to Figures 2 and 3.

NOTICE

Refer to the current sprinkler technical data page to determine the correct sprinkler wrench for the model of sprinkler used.

WARNING

Never install sprinklers that have been dropped, damaged, or exposed to temperatures in excess of the maximum ambient temperature allowed.

* Refer to the appropriate current technical data pages for complete care, handling, and installation instructions. Data pages are included with each shipment from Viking or Viking distributors. They can also be found on the Web site at www.vikinggroupinc.com.



BULLETIN

CARE AND HANDLING
OF SPRINKLERS

The Viking Corporation, 210 N Industrial Park Drive, Hastings MI 49058
 Telephone: 269-945-9501 Technical Services: 877-384-5464 Fax: 269-818-1680 Email: techsvcs@vikingcorp.com



CONCEALED COVER ASSEMBLIES ARE FRAGILE!
TO ASSURE SATISFACTORY PERFORMANCE OF THE PRODUCT, HANDLE WITH CARE.



Concealed Sprinkler and Adapter
 Assembly with Protective Cap

Concealed Sprinkler and Adapter
 Assembly (Protective Cap Removed)



Cover Plate Assembly
 (Pendent Cover 12381 shown)



GENERAL HANDLING AND STORAGE INSTRUCTIONS:

- Do not store in temperatures exceeding 100 °F (38 °C). Avoid direct sunlight and confined areas subject to heat.
- Protect sprinklers and cover assemblies during storage, transport, handling, and after installation.
 - Use original shipping containers.
 - Do not place sprinklers or cover assemblies loose in boxes, bins, or buckets.
- Keep the sprinkler bodies covered with the protective sprinkler cap any time the sprinklers are shipped or handled, during testing of the system, and while ceiling finish work is being completed.
- Use only the designated Viking recessed sprinkler wrench (refer to the appropriate sprinkler data page) to install these sprinklers. **NOTE:** The protective cap is temporarily removed during installation and then placed back on the sprinkler for protection until finish work is completed.
- Do not over-tighten the sprinklers into fittings during installation.
- Do not use the sprinkler deflector to start or thread the sprinklers into fittings during installation.
- Do not attempt to remove drywall, paint, etc., from the sprinklers.
- Remove the plastic protective cap from the sprinkler before attaching the cover plate assembly. **PROTECTIVE CAPS MUST BE REMOVED FROM SPRINKLERS BEFORE PLACING THE SYSTEM IN SERVICE!**

Refer to the appropriate current technical data pages for complete care, handling, and installation instructions. Data pages are included with each shipment from Viking or Viking distributors. They can also be found on the Web site at www.vikinggroupinc.com.



BULLETIN

CARE AND HANDLING
OF SPRINKLERS

The Viking Corporation, 210 N Industrial Park Drive, Hastings MI 49058

Telephone: 269-945-9501 Technical Services: 877-384-5464 Fax: 269-818-1680 Email: techsvcs@vikingcorp.com

USE THE FOLLOWING PRECAUTIONS WHEN HANDLING WAX-COATED SPRINKLERS

Many of Viking's sprinklers are available with factory-applied wax coating for corrosion resistance. These sprinklers MUST receive appropriate care and handling to avoid damaging the wax coating and to assure satisfactory performance of the product.

General Handling and Storage of Wax-Coated Sprinklers:

- Store the sprinklers in a cool, dry place (in temperatures below the maximum ambient temperature allowed for the sprinkler temperature rating. Refer to Table 1 below.)
- Store containers of wax-coated sprinklers separate from other sprinklers.
- Protect the sprinklers during storage, transport, handling, and after installation.
- Use original shipping containers.
- Do not place sprinklers in loose boxes, bins, or buckets.

Installation of Wax-Coated Sprinklers:

Use only the special sprinkler head wrench designed for installing wax-coated Viking sprinklers (any other wrench may damage the unit).

- Take care not to crack the wax coating on the units.
- For touching up the wax coating after installation, wax is available from Viking in bar form. Refer to Table 1 below. The coating MUST be repaired after sprinkler installation to protect the corrosion-resistant properties of the sprinkler.
- Use care when locating sprinklers near fixtures that can generate heat. Do not install sprinklers where they would be exposed to temperatures exceeding the maximum recommended ambient temperature for the temperature rating used.
- Inspect the coated sprinklers frequently soon after installation to verify the integrity of the corrosion resistant coating. Thereafter, inspect representative samples of the coated sprinklers in accordance with NFPA 25. Close up visual inspections are necessary to determine whether the sprinklers are being affected by corrosive conditions.

TABLE 1

Sprinkler Temperature Rating (Fusing Point)	Wax Part Number	Wax Melting Point	Maximum Ambient Ceiling Temperature ¹	Wax Color
155 °F (68 °C) / 165 °F (74 °C)	02568A	148 °F (64 °C)	100 °F (38 °C)	Light Brown
175 °F (79 °C)	04146A	161 °F (71 °C)	150 °F (65 °C)	Brown
200 °F (93 °C)	04146A	161 °F (71 °C)	150 °F (65 °C)	Brown
220 °F (104 °C)	02569A	170 °F (76 °C)	150 °F (65 °C)	Dark Brown
286 °F (141 °C)	02569A	170 °F (76 °C)	150 °F (65 °C)	Dark Brown

¹ Based on NFPA-13. Other limits may apply, depending on fire loading, sprinkler location, and other requirements of the Authority Having Jurisdiction. Refer to specific installation standards.



Never install sprinklers that have been dropped, damaged, or exposed to temperatures in excess of the maximum ambient temperature allowed.

Refer to the appropriate current technical data pages for complete care, handling, and installation instructions. Data pages are included with each shipment from Viking or Viking distributors. They can also be found on the Web site at www.vikinggroupinc.com.



TECHNICAL DATA

SPRINKLER OVERVIEW

The Viking Corporation, 210 N Industrial Park Drive, Hastings MI 49058

Telephone: 269-945-9501 Technical Services: 877-384-5464 Fax: 269-818-1680 Email: techsvcs@vikingcorp.com

1. DESCRIPTION

Viking fire sprinklers consist of a threaded frame with a specific waterway or orifice size and a deflector for distributing water in a specified pattern. A closed or sealed sprinkler refers to a complete assembly, including the thermosensitive operating element. An open sprinkler does not use an operating element and is open at all times. The distribution of water is intended to extinguish a fire or to control its spread.

Viking sprinklers are available in several models and styles. Refer to specific sprinkler technical data pages for available styles, finishes, temperature ratings, thread sizes, and nominal K-Factors for the particular model selected.

2. LISTINGS AND APPROVALS

Refer to the Approval Charts on the appropriate sprinkler technical data page(s) and/or approval agency listings.



WARNING: Cancer and Reproductive Harm-
www.P65Warnings.ca.gov

3. TECHNICAL DATA

Pressure Ratings:

Maximum allowable water working pressure is 175 psig (12 Bar) unless rated and specified for high water working pressure [250 psig (17.2 bar)].

Sprinkler Identification:

Viking sprinklers are identified and marked with the word "Viking", the sprinkler identification number (SIN) consisting of "VK" plus a three digit number*, the model letter, and the year of manufacture.

Available Finishes:

Viking sprinklers are available in several decorative finishes. Some models are available with corrosion-resistant coatings or are fabricated from non-corrosive material. Refer to the sprinkler technical data page for additional information.

Available Temperature Ratings:

Viking sprinklers are available in several temperature ratings that relate to a specific temperature classification. Applicable installation rules mandate the use and limitations of each temperature classification. In selecting the appropriate temperature classification, the maximum expected ceiling temperature must be known. When there is doubt as to the maximum temperature at the sprinkler location, a maximum-reading thermometer should be used to determine the temperature under conditions that would show the highest readings to be expected. In addition, recognized installation rules may require a higher temperature classification, depending upon sprinkler location, occupancy classification, commodity classification, storage height, and other hazards. In all cases, the maximum expected ceiling temperature dictates the lowest allowable temperature classification. Sprinklers located immediately adjacent to a heat source may require a higher temperature rating.

K-Factors:

Viking sprinklers are available in several orifice sizes with related K-Factors. The orifice is a tapered waterway and, therefore, the K-Factor given is nominal. Nominal U.S. K-Factors are provided in accordance with the 1999 edition of NFPA 13, Section 3-2.3. Refer to the specific data page for appropriate K-Factor information.

Available Styles:

Viking sprinklers are available for installation in several positions as indicated by a stamping on the deflector. The deflector style dictates the appropriate installation position of the sprinkler; it breaks the solid stream of water issuing from the sprinkler orifice to form a specific spray pattern. The following list indicates the various styles and identification of Viking sprinklers.

UPRIGHT SPRINKLER: A sprinkler intended to be installed with the deflector above the frame so water flows upward through the orifice, striking the deflector and forming an umbrella-shaped spray pattern downward. Marked "SSU" (Standard Sprinkler Upright) or "UPRIGHT" on the deflector.

PENDENT SPRINKLER: A sprinkler intended to be oriented with the deflector below the frame so water flows downward through the orifice, striking the deflector and forming an umbrella-shaped spray pattern downward. Marked "SSP" (Standard Sprinkler Pendent) or "PENDENT" on the deflector.

CONVENTIONAL SPRINKLER: An "old style" sprinkler intended to be installed with the deflector in either the upright or pendent position. The deflector provides a spherical type pattern with 40 to 60 percent of the water initially directed downward and a proportion directed upward. Must be installed in accordance with installation rules for conventional or old style sprinklers. **DO NOT USE AS A REPLACEMENT FOR STANDARD SPRAY SPRINKLERS.** Marked "C U/P" (Conventional Upright/Pendent) on the deflector.

Viking Technical Data may be found on
The Viking Corporation's Web site at
<http://www.vikinggroupinc.com>.
The Web site may include a more recent
edition of this Technical Data Page.



TECHNICAL DATA

SPRINKLER OVERVIEW

The Viking Corporation, 210 N Industrial Park Drive, Hastings MI 49058

Telephone: 269-945-9501 Technical Services: 877-384-5464 Fax: 269-818-1680 Email: techsvcs@vikingcorp.com

VERTICAL SIDEWALL (VSW) SPRINKLER: A sprinkler intended for installation near the wall and ceiling. The deflector provides a water spray pattern outward in a quarter-spherical pattern and can be installed in the upright or pendent position with the flow arrow in the direction of discharge. Marked "SIDEWALL" on the deflector with an arrow and the word "FLOW". (Note: Some vertical sidewall sprinklers can only be installed in the upright or pendent position—in this case, the sprinkler will also be marked "UPRIGHT" or "PENDENT".)

HORIZONTAL SIDEWALL (HSW) SPRINKLER: A sprinkler intended for installation near the wall and ceiling. The special deflector provides a water spray pattern outward in a quarter-spherical pattern. Most of the water is directed away from the nearby wall with a small portion directed at the wall behind the sprinkler. The top of the deflector is oriented parallel with the ceiling or roof. The flow arrows point in the direction of discharge. Marked "SIDEWALL" and "TOP" with an arrow and the word "FLOW".

EXTENDED COVERAGE (EC) SPRINKLER: A spray sprinkler designed to discharge water over an area having the maximum dimensions indicated in the individual listings. Maximum area of coverage, minimum flow rate, orifice size, and nominal K-Factor are specified in the individual listings. EC sprinklers are intended for Light-Hazard occupancies with smooth, flat, horizontal ceilings unless otherwise specified. In addition to the above markings, the sprinkler is marked "EC".

QUICK RESPONSE (QR) SPRINKLER: A spray sprinkler with a fast-actuating operating element. The use of quick response sprinklers may be limited due to occupancy and hazard. Refer to the Authority Having Jurisdiction (AHJ) prior to installing.

QUICK RESPONSE EXTENDED COVERAGE (QREC) SPRINKLER: A spray sprinkler designed to discharge water over an area having the maximum dimensions indicated in the individual listing. This is a sprinkler with an operating element that meets the criteria for quick response. QREC sprinklers are only intended for Light Hazard occupancies. The sprinkler is marked "QREC".

FLUSH SPRINKLER: A decorative spray sprinkler intended for installation with a concealed piping system. The unit is mounted flush with the ceiling or wall, with the fusible link exposed. Upon actuation, the deflector extends beyond the ceiling or wall to distribute water discharge. The sprinkler is marked "SSP", "PEND", or "SIDEWALL" and "TOP".

CONCEALED SPRINKLER: A decorative spray sprinkler intended for installation with a concealed piping system. The sprinkler is hidden from view by a cover plate installed flush with the ceiling or wall. During fire conditions, the cover plate detaches, and upon sprinkler actuation, the deflector extends beyond the ceiling or wall to distribute water discharge. The sprinkler is marked "SSP", "PEND", or "SIDEWALL" and "TOP".

RECESSED SPRINKLER: A spray sprinkler assembly intended for installation with a concealed piping system. The assembly consists of a sprinkler installed in a decorative adjustable recessed escutcheon that minimizes the protrusion of the sprinkler beyond the ceiling or wall without adversely affecting the sprinkler distribution or sensitivity. Refer to the appropriate technical data page for allowable sprinkler models, temperature ratings, and occupancy classifications. DO NOT RECESS ANY SPRINKLER NOT LISTED FOR USE WITH THE ESCUTCHEON.

CORROSION-RESISTANT SPRINKLER: A special service sprinkler with non-corrosive protective coatings, or that is fabricated from non-corrosive material, for use in atmospheres that would normally corrode sprinklers.

DRY SPRINKLER: A special-service sprinkler intended for installation on dry pipe systems or wet pipe systems where the sprinkler is subject to freezing temperatures. The unit consists of a sprinkler permanently secured to an extension nipple with a sealed inlet end to prevent water from entering the nipple until the sprinkler operates. The unit MUST be installed in a tee fitting. Dry upright sprinklers are marked with the "B" dimension [distance from the face of the fitting (tee) to the top of the deflector]. Dry pendent and sidewall sprinklers are marked with the "A" dimension [the distance from the face of fitting (tee) to the finished surface of the ceiling or wall].

LARGE DROP SPRINKLER: A type of special application sprinkler used to provide fire control of specific high-challenge fire hazards. Large drop sprinklers are designed to produce an umbrella-shaped spray pattern downward with a higher percentage of "large" water droplets than standard spray sprinklers. The sprinkler has an extra-large orifice with a nominal K-Factor of 11.2. Marked "HIGH CHALLENGE" and "UPRIGHT".

EARLY SUPPRESSION FAST-RESPONSE (ESFR) SPRINKLER: A sprinkler intended to provide fire suppression of specific high-challenge fire hazards through the use of a fast response fusible link, 14.0, 16.8, or 25.2 nominal K-Factor, and special deflector. ESFR sprinklers are designed to produce high-momentum water droplets in a hemispherical pattern below the deflector. This permits penetration of the fire plume and direct wetting of the burning fuel surface while cooling the atmosphere early in the development of a high-challenge fire. Marked "ESFR" and "UPRIGHT" or "PEND".

INTERMEDIATE LEVEL/RACK STORAGE SPRINKLER: A standard spray sprinkler assembly designed to protect its operating element from the spray of sprinklers installed at higher elevations. The assembly consists of a standard or large orifice upright or pendent sprinkler with an integral upright or pendent water shield and guard assembly. Use only those sprinklers that have been tested and listed for use with the assembly. Refer to the technical data page for allowable sprinkler models.

RESIDENTIAL SPRINKLER: A sprinkler intended for use in the following occupancies: one- and two-family dwellings with the fire protection sprinkler system installed in accordance with NFPA 13D; residential occupancies up to four stories in height with the fire protection system installed in accordance with NFPA 13R; and where allowed by the Authority Having Jurisdiction in residential portions of any occupancy with the fire protection system installed in accordance with NFPA 13.



TECHNICAL DATA

SPRINKLER OVERVIEW

The Viking Corporation, 210 N Industrial Park Drive, Hastings MI 49058

Telephone: 269-945-9501 Technical Services: 877-384-5464 Fax: 269-818-1680 Email: techsvcs@vikingcorp.com

Residential sprinklers have a unique distribution pattern and utilize a “fast response” heat sensitive operating element. They enhance survivability in the room of fire origin and are designed to provide a life safety environment for a minimum of ten minutes. For this reason, residential sprinklers must not be used to replace standard sprinklers unless tested for and approved by the Authority Having Jurisdiction. In addition to standard markings, the unit is identified as “RESIDENTIAL SPRINKLER” or “RES”.

4. INSTALLATION

Refer to appropriate NFPA Installation Standards.

5. OPERATION

Refer to the appropriate sprinkler technical data page(s).

6. INSPECTIONS, TESTS AND MAINTENANCE

Refer to NFPA 25 for Inspection, Testing and Maintenance requirements.

7. AVAILABILITY

Viking sprinklers are available through a network of domestic and international distributors. See The Viking Corporation web site for the closest distributor or contact The Viking Corporation.

8. GUARANTEE

For details of warranty, refer to Viking’s current list price schedule or contact Viking directly.

IMPORTANT: Always refer to Bulletin Form No. F_091699 - Care and Handling of Sprinklers and the appropriate sprinkler general care, installation, and maintenance guide. Vikings sprinklers are to be installed in accordance with the latest edition of Viking technical data, the appropriate standards of NFPA, FM Global, LPCB, APSAD, VdS or other similar organizations, and also with the provisions of governmental codes, ordinances, and standards, whenever applicable. The sprinkler technical data page may contain installation requirements specific for the sprinkler model selected. The use of certain types of sprinklers may be limited due to occupancy and hazard. Refer to the Authority Having Jurisdiction prior to installation.

**BULLETIN****REGULATORY AND HEALTH
WARNINGS**

The Viking Corporation, 210 N Industrial Park Drive, Hastings MI 49058

Telephone: 269-945-9501 Technical Services: 877-384-5464 Fax: 269-818-1680 Email: techsvcs@vikingcorp.com

Visit the Viking website for the latest edition of this technical data page www.vikinggroupinc.com

1. DESCRIPTION

Regulatory and Health Warnings applying to materials used in the manufacture and construction of fire protection products are provided herein as they relate to legally mandated jurisdictional regions.

⚠ WARNING**STATE OF CALIFORNIA, USA**

Installing or servicing fire protection products such as sprinklers, valves, piping etc. can expose you to chemicals including, but not limited to, lead, nickel, butadiene, titanium dioxide, chromium, carbon black, and acrylonitrile which are known to the State of California to cause cancer or birth defects or other reproductive harm.

For more information, go to www.P65Warnings.ca.gov

2. WARRANTY TERMS AND CONDITIONS

For details of warranty, refer to Viking's current list price schedule at www.vikinggroupinc.com or contact Viking directly.



TECHNICAL DATA

MICROFAST® SR/QR EXTENDED COVERAGE PENDENT SPRINKLER VK600 (K5.6)

The Viking Corporation, 210 N Industrial Park Drive, Hastings MI 49058

Telephone: 269-945-9501 Technical Services: 877-384-5464 Fax: 269-818-1680 Email: techsvcs@vikingcorp.com

Visit the Viking website for the latest edition of this technical data page www.vikinggroupinc.com

1. DESCRIPTION

Viking Microfast® EC/QREC Pendent Sprinkler VK600 is a small thermosensitive spray sprinkler available in several different finishes and temperature ratings to meet varying design requirements. The VK600 has both standard response and quick response listings. The glass bulb operating element and special deflector characteristics meet the challenges of quick response extended coverage standards. The special Polyester and Electroless Nickel PTFE (ENT) coatings can be used in decorative applications where colors are desired. In addition, the ENT coating has been investigated for installation in corrosive environments and is listed/approved as indicated in the Approval Charts.

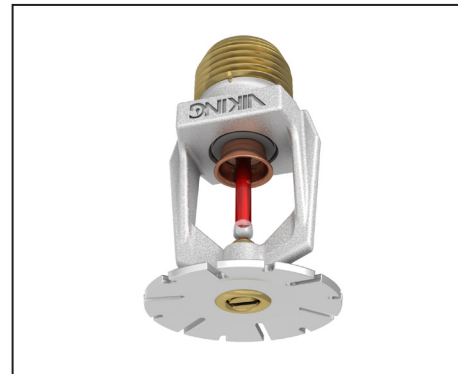

For Light Hazard Occupancies Only



WARNING: Cancer and Reproductive Harm-
www.P65Warnings.ca.gov

2. LISTINGS AND APPROVALS



cULus Listed: Category VNIV



FM Approved: Class 2020

Refer to Approval Charts and Design Criteria for listing and approval requirements that must be followed.

3. TECHNICAL DATA

Specifications:

Minimum Operating Pressure: Refer to the Approval Charts.

Maximum Working Pressure: 175 psi (12 Bar).

Factory tested hydrostatically to 500 psi (34.5 bar).

Thread sizes: 1/2" (15 mm) NPT

Nominal K-Factors: 5.6 U.S. (80.6 metric†)

† Metric K-factor measurement shown is in Bar. When pressure is measured in kPa, divide the metric K-factor shown by 10.0.

Glass-bulb fluid temperature rated to -65 °F (-55 °C)

Overall Length: 2-5/16 (59 mm)

Material Standards:

Sprinkler Frame: Brass UNS-C84400 or QM Brass

Deflector: Brass UNS-C26000

Bulb: Glass, nominal 3 mm diameter

Belleville Spring Sealing Assembly: Nickel Alloy, coated on both sides with PTFE Tape

Screw: Brass UNS-C36000

Pip Cap and Insert Assembly: Copper UNS-C11000 and Stainless Steel UNS-S30400

For ENT Coated Sprinklers: Belleville Spring-Exposed, Screw and Pip Cap-ENT Coated

For Polyester Coated Sprinklers: Belleville Spring-Exposed

Ordering Information: (Also refer to the current Viking price list.)

Order Microfast® EC/QREC Pendent Sprinkler VK600 by first adding the appropriate suffix for the sprinkler finish and then the appropriate suffix for the temperature rating to the sprinkler base part number.

Finish Suffix: Brass = A, Chrome = F, White Polyester = M-/W, Black Polyester = M-/B, and ENT = JN

Temperature Suffix: 135 °F (57 °C) = A, 155 °F (68 °C) = B, 175 °F (79 °C) = D

For example, sprinkler VK600 with a Brass finish and a 155 °F (68 °C) temperature rating = Part No. 06778BAB

Available Finishes And Temperature Ratings:

Refer to Table 1.

Accessories: (Also refer to the Viking website.)

Sprinkler Wrenches:

A. Standard Wrench: Part No. 21475M/B (available since 2017)

B. Wrench for recessed pendent sprinklers: Part No. 13577W/B**
(available since 2006)

**A 1/2" ratchet is required (not available from Viking).

Sprinkler Cabinets:

A. Six-head capacity: Part No. 01724A (available since 1971)

B. Twelve-head capacity: Part No. 01725A (available since 1971)

	TECHNICAL DATA	MICROFAST® SR/QR EXTENDED COVERAGE PENDENT SPRINKLER VK600 (K5.6)
---	-----------------------	--

The Viking Corporation, 210 N Industrial Park Drive, Hastings MI 49058
 Telephone: 269-945-9501 Technical Services: 877-384-5464 Fax: 269-818-1680 Email: techsvcs@vikingcorp.com
 Visit the Viking website for the latest edition of this technical data page www.vikinggroupinc.com

4. INSTALLATION

Refer to appropriate NFPA Installation Standards.

5. OPERATION

During fire conditions, the heat-sensitive liquid in the glass bulb expands, causing the glass to shatter, releasing the pip cap and sealing spring assembly. Water flowing through the sprinkler orifice strikes the sprinkler deflector, forming a uniform spray pattern to extinguish or control the fire.

6. INSPECTIONS, TESTS AND MAINTENANCE

Refer to NFPA 25 for Inspection, Testing and Maintenance requirements.

7. AVAILABILITY

Viking Microfast® EC/QREC Pendent Sprinkler VK600 is available through a network of domestic and international distributors. See The Viking Corporation web site for the closest distributor or contact The Viking Corporation.

8. GUARANTEE

For details of warranty, refer to Viking’s current list price schedule or contact Viking directly.

TABLE 1: AVAILABLE SPRINKLER TEMPERATURE RATINGS AND FINISHES

Sprinkler Temperature Classification	Sprinkler Nominal Temperature Rating ¹	Maximum Ambient Ceiling Temperature ²	Bulb Color
Ordinary	135 °F (57 °C)	100 °F (38 °C)	Orange
Ordinary	155 °F (68 °C)	100 °F (38 °C)	Red
Intermediate	175 °F (79 °C)	150 °F (65 °C)	Yellow

Sprinkler Finishes: Brass, Chrome, White Polyester⁵, Black Polyester⁵, and ENT^{3,4}

Corrosion Resistant Sprinkler Coatings: ENT^{3,4}

Footnotes

- ¹ The sprinkler temperature rating is stamped on the deflector.
- ² Based on NFPA-13. Other limits may apply, depending on fire loading, sprinkler location, and other requirements of the Authority Having Jurisdiction. Refer to specific installation standards.
- ³ The corrosion-resistant coatings have passed the standard corrosion test required by the approving agencies indicated in the Approval Charts. These tests cannot and do not represent all possible corrosive environments. Prior to installation, verify through the end-user that the coatings are compatible with or suitable for the proposed environment. Note that the spring is exposed on sprinklers with ENT coatings. For ENT coated automatic sprinklers, the waterway is coated.
- ⁴ cULus Listed as corrosion resistant.
- ⁵ For automatic sprinklers, the coatings indicated are applied to the exposed exterior surfaces only. Note that the spring is exposed on sprinklers with Polyester coatings.

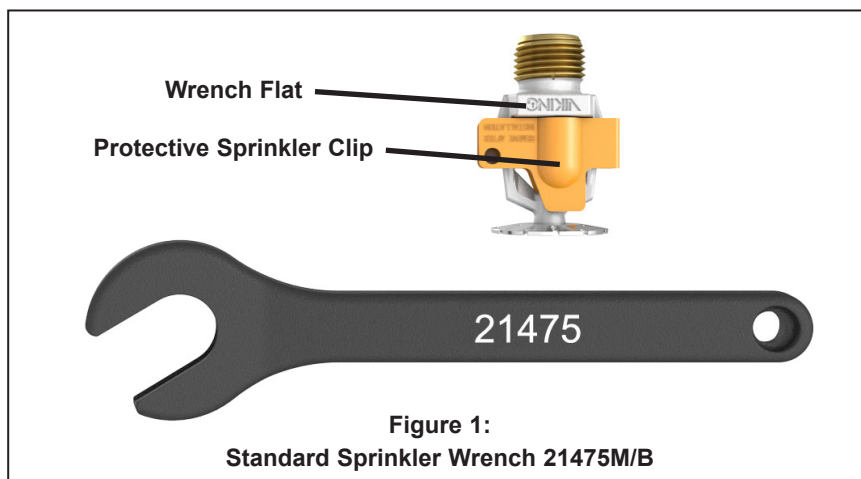



TECHNICAL DATA

MICROFAST® SR/QR EXTENDED COVERAGE PENDENT SPRINKLER VK600 (K5.6)

The Viking Corporation, 210 N Industrial Park Drive, Hastings MI 49058
 Telephone: 269-945-9501 Technical Services: 877-384-5464 Fax: 269-818-1680 Email: techsvcs@vikingcorp.com
 Visit the Viking website for the latest edition of this technical data page www.vikinggroupinc.com

Approval Chart 1 (UL)

Microfast® SR/QR Extended Coverage Pendent Sprinkler VK600
 For Light Hazard Occupancies Only.
 Maximum 175 PSI (12 Bar) WWP

KEY	
Temperature	—
Finish	↓
Escutcheon (if applicable)	A1X ←

Sprinkler Base Part No. ¹	SIN	NPT Thread Size		Nominal K-Factor		Maximum Areas of Coverage ⁴ (Length x Width)	Minimum Water Supply Requirements ⁴ Flow/Pressure	Listings and Approvals ³ (Refer also to UL Design Criteria)	
		Inches	mm	U.S.	metric ²				
Standard Response Applications⁶									
06778B	VK600	1/2	15	5.6	80.6	20' x 20' (6.1 m x 6.1 m)	40 gpm @ 51.0 psi (151.4 L/min @ 3.52 Bar)	A1Z, A2X	
Quick Response Applications									
06778B	VK600	1/2	15	5.6	80.6	16' x 16' (4.9 m x 4.9 m)	26 gpm @ 21.6 psi (98.4 L/min @ 1.49 Bar)	C1Z, A2X	
06778B	VK600	1/2	15	5.6	80.6	18' x 18' (5.5 m x 5.5 m)	33 gpm @ 34.7 psi (124.9 L/min @ 2.39 Bar)	C1Z, A2X	
06778B	VK600	1/2	15	5.6	80.6	20' x 20' (6.1 m x 6.1 m)	40 gpm @ 51.0 psi (151.4 L/min @ 3.52 Bar)	B1Y	
Sprinkler Temperature Ratings A - 155 °F (68 °C) and 175 °F (79 °C) B - 135 °F (57 °C) C - 135 °F (57 °C), 155 °F (68 °C), and 175 °F (79 °C)						Approved Finishes 1 - Brass, Chrome, White Polyester, and Black Polyester 2 - ENT ⁷		Approved Escutcheons X - Standard surface-mounted escutcheons or recessed with the Micromatic® Model E-1 Recessed Escutcheon Y - Standard surface-mounted escutcheons Z - Standard surface-mounted escutcheons or recessed with the Micromatic® Model E-1, E-2, or E-3 Recessed Escutcheon	
Footnotes									
¹ Part number shown is the base part number. For complete part number, refer to current Viking price list schedule. ² Metric K-factor measurement shown is when pressure is measured in Bar. When pressure is measured in kPa, divide the metric K-factor shown by 10.0. ³ This chart shows the listings and approvals available at the time of printing. Other approvals may be in process. Check with the manufacturer for any additional approvals. ⁴ For areas of coverage smaller than shown, use the "Minimum Water Supply Requirement" for the next larger area listed with sprinklers of similar K-factor. Flows and pressures listed are per sprinkler. ⁵ Listed by Underwriter's Laboratories, Inc. for use in the U.S. and Canada for Light Hazard occupancies with smooth, flat, horizontal ceilings only. ⁶ cULus Listings are limited to Light Hazard occupancies, where allowed by the installation standards being applied. ⁷ cULus Listed as corrosion resistant.									

DESIGN CRITERIA - UL

(Also refer to Approval Chart 1.)

cULus Listing Requirements:

Standard/Quick Response Extended Coverage Pendent Sprinkler VK600 is cULus Listed as indicated in the Approval Chart for installation in accordance with the latest edition of NFPA 13 for extended coverage pendent spray sprinklers:

- Limited to Light Hazard occupancies, where allowed by the installation standards being applied, with smooth, flat, horizontal ceilings only.
- Minimum spacing allowed is 8 ft. (2.4 m) unless baffles are installed in accordance with NFPA 13.
- Minimum distance from walls is 4 in. (102 mm).
- Maximum distance from walls shall be no more than one-half of the allowable distance between sprinklers. The distance shall be measured perpendicular to the wall.
- The sprinkler installation and obstruction rules contained in NFPA 13 for extended coverage pendent spray sprinklers must be followed.
- Venting is not required.

IMPORTANT: Always refer to Bulletin Form No. F_091699 - Care and Handling of Sprinklers. Also refer to Form No. F_080614 for general care, installation, and maintenance information. Viking sprinklers are to be installed in accordance with the latest edition of Viking technical data, the appropriate standards of NFPA, LPCB, APSAD, VdS or other similar organizations, and also with the provisions of governmental codes, ordinances, and standards, whenever applicable.



TECHNICAL DATA

MICROFAST® SR/QR EXTENDED COVERAGE PENDENT SPRINKLER VK600 (K5.6)

The Viking Corporation, 210 N Industrial Park Drive, Hastings MI 49058

Telephone: 269-945-9501 Technical Services: 877-384-5464 Fax: 269-818-1680 Email: techsvcs@vikingcorp.com

Visit the Viking website for the latest edition of this technical data page www.vikinggroupinc.com

Approval Chart 2 (FM)

Microfast® Quick Response Extended Coverage Pendent Sprinkler VK600
Maximum 175 PSI (12 Bar) WWP

KEY	
Temperature	Temperature
Finish	Finish
A1X ←	Escutcheon (if applicable)

Sprinkler Base Part Number ¹	SIN	NPT Thread Size		Nominal K-Factor		Maximum Areas of Coverage ⁴ (Length x Width)	Minimum Water Supply Requirements ⁴ Flow/Pressure	FM Approvals ³ (Refer also to Design Criteria below.)	
		Inches	mm	U.S.	metric ²				
06778B	VK600	1/2	15	5.6	80.6	16' x 16' (4.9 m x 4.9 m)	26 gpm @ 21.6 psi (98.4 L/min @ 1.49 Bar)	A1Z, B2Y	
06778B	VK600	1/2	15	5.6	80.6	18' x 18' (5.5 m x 5.5 m)	33 gpm @ 34.7 psi (124.9 L/min @ 2.39 Bar)	A1Z, B2Y	
06778B	VK600	1/2	15	5.6	80.6	20' x 20' (6.1 m x 6.1 m)	40 gpm @ 51.0 psi (151.4 L/min @ 3.52 Bar)	A1Z, B2Y	
Sprinkler Temperature Ratings A - 135 °F (57 °C), 155 °F (68 °C), and 175 °F (79 °C) B - 155 °F (68 °C), and 175 °F (79 °C)		Approved Finishes 1 - Brass, Chrome, White Poly-ester, and Black Polyester 2 - ENT ⁵				Approved Escutcheons Y - Standard surface-mounted escutcheons or recessed with the Micromatic® Model E-1 Recessed Escutcheon Z - Standard surface-mounted escutcheons or the or recessed with the Micromatic® Model E-1, E-2, or E-3 Recessed Escutcheon			

Footnotes

¹ Part number shown is the base part number. For complete part number, refer to current Viking price list schedule.

² Metric K-factor measurement shown is when pressure is measured in Bar. When pressure is measured in kPa, divide the metric K-factor shown by 10.0.

³ This chart shows the FM Approvals available at the time of printing. Other approvals may be in process. Check with the manufacturer for any additional approvals.

⁴ For areas of coverage smaller than shown, use the "Minimum Water Supply Requirement" for the next larger area listed with sprinklers of similar K-factor. Flows and pressures listed are per sprinkler.

⁵ FM Approved as corrosion resistant.

DESIGN CRITERIA - FM

(Also refer to Approval Chart 2 above.)

FM Approval Requirements:

Quick Response Extended Coverage Pendent Sprinkler VK600 is FM Approved as a quick response **Non-Storage** extended coverage pendent sprinkler as indicated in the FM Approval Guide. For specific application and installation requirements, reference the latest applicable FM Loss Prevention Data Sheets (including Data Sheet 2-0). FM Global Loss Prevention Data Sheets contain guidelines relating to, but not limited to: minimum water supply requirements, hydraulic design, ceiling slope and obstructions, minimum and maximum allowable spacing, and deflector distance below the ceiling.

NOTE: The FM installation guidelines may differ from cULus and/or NFPA criteria.

IMPORTANT: Always refer to Bulletin Form No. F_091699 - Care and Handling of Sprinklers. Also refer to Form No. F_080614 for general care, installation, and maintenance information. Viking sprinklers are to be installed in accordance with the latest edition of Viking technical data, the appropriate standards of NFPA, FM Global, LPCB, APSAD, VdS or other similar organizations, and also with the provisions of governmental codes, ordinances, and standards, whenever applicable.



TECHNICAL DATA

**MICROFAST® SR/QR
EXTENDED COVERAGE
PENDENT SPRINKLER
VK600 (K5.6)**

The Viking Corporation, 210 N Industrial Park Drive, Hastings MI 49058
 Telephone: 269-945-9501 Technical Services: 877-384-5464 Fax: 269-818-1680 Email: techsvcs@vikingcorp.com
 Visit the Viking website for the latest edition of this technical data page www.vikinggroupinc.com

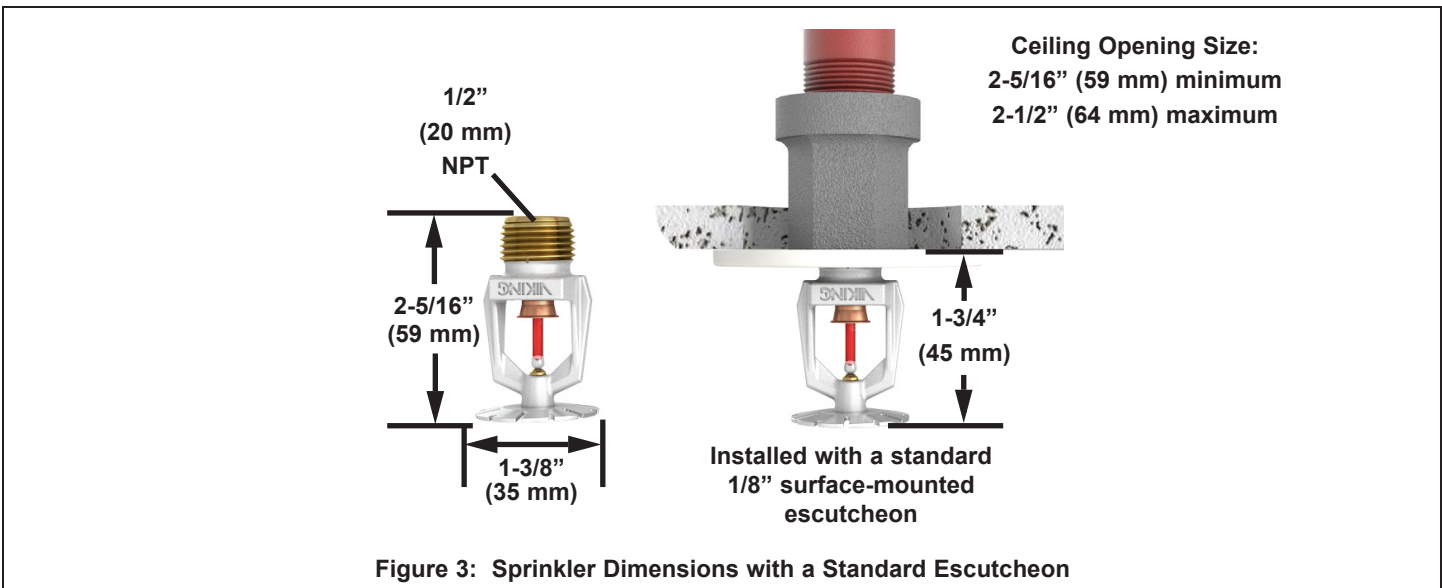
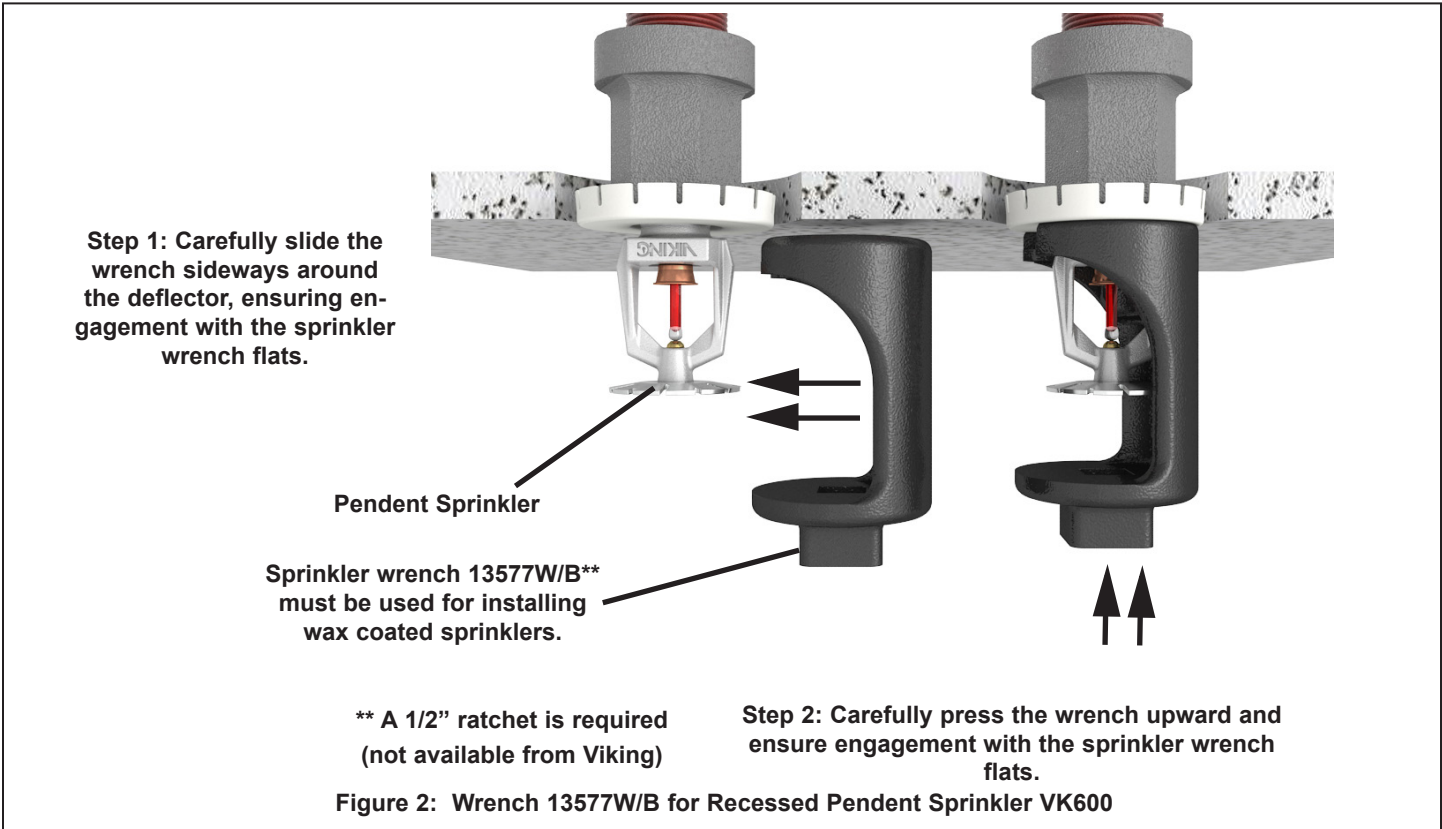



TECHNICAL DATA

**MICROFAST® SR/QR
EXTENDED COVERAGE
PENDENT SPRINKLER
VK600 (K5.6)**

The Viking Corporation, 210 N Industrial Park Drive, Hastings MI 49058
Telephone: 269-945-9501 Technical Services: 877-384-5464 Fax: 269-818-1680 Email: techsvcs@vikingcorp.com
Visit the Viking website for the latest edition of this technical data page www.vikinggroupinc.com

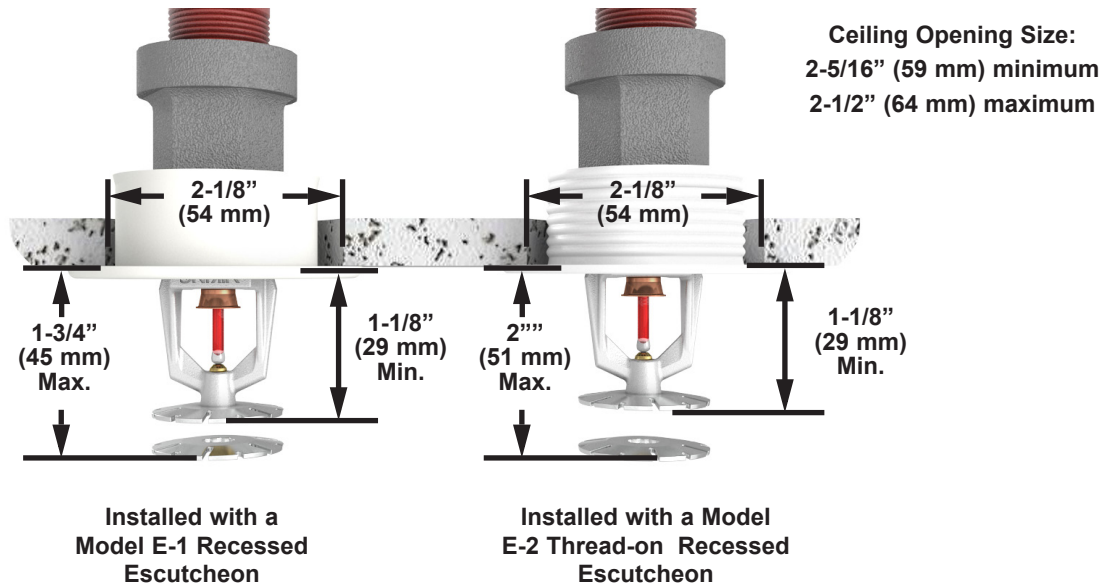

Figure 4: Sprinkler Dimensions with the Model E-1 and E-2 Recessed Escutcheons



BULLETIN

CARE AND HANDLING OF SPRINKLERS

The Viking Corporation, 210 N Industrial Park Drive, Hastings MI 49058
 Telephone: 269-945-9501 Technical Services: 877-384-5464 Fax: 269-818-1680 Email: techsvcs@vikingcorp.com

SPRINKLERS ARE FRAGILE - HANDLE WITH CARE!

General Handling and Storage:

- Store sprinklers in a cool, dry place.
- Protect sprinklers during storage, transport, handling, and after installation.
- Use the original shipping containers. DO NOT place sprinklers loose in boxes, bins, or buckets.
- Keep sprinklers separated at all times. DO NOT allow metal parts to contact sprinkler operating elements.

For Pre-Assembled Drops:

- Protect sprinklers during handling and after installation.
- For recessed assemblies, use the protective sprinkler cap (Viking Part Number 10364).

Sprinklers with Protective Shields or Caps:

- DO NOT remove shields or caps until after sprinkler installation and there no longer is potential for mechanical damage to the sprinkler operating elements.
- **Sprinkler shields or caps MUST be removed BEFORE placing the system in service!**
- Remove the sprinkler shield by carefully pulling it apart where it is snapped together.
- Remove the cap by turning it slightly and pulling it off the sprinkler.

Sprinkler Installation:

- DO NOT use the sprinkler deflector or operating element to start or thread the sprinkler into a fitting.
- **Use only the designated sprinkler head wrench!** Refer to the current sprinkler technical data page to determine the correct wrench for the model of sprinkler used.
- DO NOT install sprinklers onto piping at the floor level.
- Install sprinklers after the piping is in place to prevent mechanical damage.
- DO NOT allow impacts such as hammer blows directly to sprinklers or to fittings, pipe, or couplings in close proximity to sprinklers. Sprinklers can be damaged from direct or indirect impacts.
- DO NOT attempt to remove drywall, paint, etc., from sprinklers.
- **Take care not to over-tighten the sprinkler and/or damage its operating parts!**

Maximum Torque:

- 1/2" NPT: 14 ft-lbs. (19.0 N-m)**
- 3/4" NPT: 20 ft-lbs. (27.1 N-m)**
- 1" NPT: 30 ft-lbs. (40.7 N-m)**



CORRECT
(Original container used)

INCORRECT
(Placed loose in box)

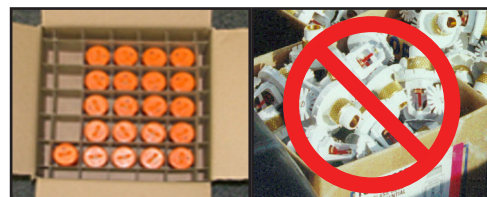

CORRECT
(Protected with caps)

INCORRECT
(Protective caps not used)



CORRECT
(Piping is in place at the ceiling)

INCORRECT
(Sprinkler at floor level)



CORRECT
(Special installation wrenches)

INCORRECT
(Designated wrench not used)

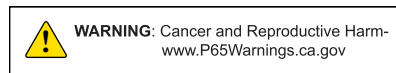

! WARNING

Any sprinkler with a loss of liquid from the glass bulb or damage to the fusible element should be destroyed. Never install sprinklers that have been dropped, damaged, or exposed to temperatures exceeding the maximum ambient temperature allowed. Sprinklers that have been painted in the field must be replaced per NFPA 13. Protect sprinklers from paint and paint overspray in accordance with the installation standards. Do not clean sprinklers with soap and water, ammonia, or any other cleaning fluid. Do not use adhesives or solvents on sprinklers or their operating elements.

Refer to the appropriate technical data page and NFPA standards for complete care, handling, installation, and maintenance instructions. For additional product and system information Viking data pages and installation instructions are available on the Viking Web site at www.vikinggroupinc.com.



BULLETIN

CARE AND HANDLING
OF SPRINKLERS

The Viking Corporation, 210 N Industrial Park Drive, Hastings MI 49058
 Telephone: 269-945-9501 Technical Services: 877-384-5464 Fax: 269-818-1680 Email: techsvcs@vikingcorp.com

PROTECTIVE SPRINKLER SHIELDS AND CAPS

General Handling and Storage:

Many Viking sprinklers are available with a plastic protective cap or shield temporarily covering the operating elements. The snap-on shields and caps are factory installed and are intended to help protect the operating elements from mechanical damage during shipping, storage, and installation. NOTE: It is still necessary to follow the care and handling instructions on the appropriate sprinkler technical data sheets* when installing sprinklers with bulb shields or caps.

WHEN TO REMOVE THE SHIELDS AND CAPS:

NOTE: SHIELDS AND CAPS MUST BE REMOVED FROM SPRINKLERS BEFORE PLACING THE SYSTEM IN SERVICE!

Remove the shield or cap from the sprinkler only after checking all of the following:

- The sprinkler has been installed*.
- The wall or ceiling finish work is completed where the sprinkler is installed and there no longer is a potential for mechanical damage to the sprinkler operating elements.

SHIELDS AND CAPS MUST BE REMOVED FROM SPRINKLERS BEFORE PLACING THE SYSTEM IN SERVICE!



Figure 1: Sprinkler shield being removed from a pendent sprinkler.



Figure 2: Sprinkler cap being removed from a pendent sprinkler.



Figure 3: Sprinkler cap being removed from an upright sprinkler.

HOW TO REMOVE SHIELDS AND CAPS:

No tools are necessary to remove the shields or caps from sprinklers. DO NOT use any sharp objects to remove them! **Take care not to cause mechanical damage to sprinklers when removing the shields or caps.** When removing caps from fusible element sprinklers, use care to prevent dislodging ejector springs or damaging fusible elements. NOTE: Squeezing the sprinkler cap excessively could damage sprinkler fusible elements.

- To remove the shield, simply pull the ends of the shield apart where it is snapped together. Refer to Figure 1.
- To remove the cap, turn it slightly and pull it off the sprinkler. Refer to Figures 2 and 3.

NOTICE

Refer to the current sprinkler technical data page to determine the correct sprinkler wrench for the model of sprinkler used.

WARNING

Never install sprinklers that have been dropped, damaged, or exposed to temperatures in excess of the maximum ambient temperature allowed.

* Refer to the appropriate current technical data pages for complete care, handling, and installation instructions. Data pages are included with each shipment from Viking or Viking distributors. They can also be found on the Web site at www.vikinggroupinc.com.



BULLETIN

CARE AND HANDLING
OF SPRINKLERS

The Viking Corporation, 210 N Industrial Park Drive, Hastings MI 49058
 Telephone: 269-945-9501 Technical Services: 877-384-5464 Fax: 269-818-1680 Email: techsvcs@vikingcorp.com



CONCEALED COVER ASSEMBLIES ARE FRAGILE!
TO ASSURE SATISFACTORY PERFORMANCE OF THE PRODUCT, HANDLE WITH CARE.

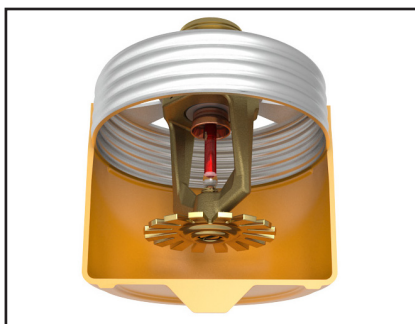

Concealed Sprinkler and Adapter
 Assembly with Protective Cap

Concealed Sprinkler and Adapter
 Assembly (Protective Cap Removed)



Cover Plate Assembly
 (Pendent Cover 12381 shown)



GENERAL HANDLING AND STORAGE INSTRUCTIONS:

- Do not store in temperatures exceeding 100 °F (38 °C). Avoid direct sunlight and confined areas subject to heat.
- Protect sprinklers and cover assemblies during storage, transport, handling, and after installation.
 - Use original shipping containers.
 - Do not place sprinklers or cover assemblies loose in boxes, bins, or buckets.
- Keep the sprinkler bodies covered with the protective sprinkler cap any time the sprinklers are shipped or handled, during testing of the system, and while ceiling finish work is being completed.
- Use only the designated Viking recessed sprinkler wrench (refer to the appropriate sprinkler data page) to install these sprinklers. **NOTE:** The protective cap is temporarily removed during installation and then placed back on the sprinkler for protection until finish work is completed.
- Do not over-tighten the sprinklers into fittings during installation.
- Do not use the sprinkler deflector to start or thread the sprinklers into fittings during installation.
- Do not attempt to remove drywall, paint, etc., from the sprinklers.
- Remove the plastic protective cap from the sprinkler before attaching the cover plate assembly. **PROTECTIVE CAPS MUST BE REMOVED FROM SPRINKLERS BEFORE PLACING THE SYSTEM IN SERVICE!**

Refer to the appropriate current technical data pages for complete care, handling, and installation instructions. Data pages are included with each shipment from Viking or Viking distributors. They can also be found on the Web site at www.vikinggroupinc.com.



BULLETIN

CARE AND HANDLING
OF SPRINKLERS

The Viking Corporation, 210 N Industrial Park Drive, Hastings MI 49058

Telephone: 269-945-9501 Technical Services: 877-384-5464 Fax: 269-818-1680 Email: techsvcs@vikingcorp.com

USE THE FOLLOWING PRECAUTIONS WHEN HANDLING WAX-COATED SPRINKLERS

Many of Viking's sprinklers are available with factory-applied wax coating for corrosion resistance. These sprinklers MUST receive appropriate care and handling to avoid damaging the wax coating and to assure satisfactory performance of the product.

General Handling and Storage of Wax-Coated Sprinklers:

- Store the sprinklers in a cool, dry place (in temperatures below the maximum ambient temperature allowed for the sprinkler temperature rating. Refer to Table 1 below.)
- Store containers of wax-coated sprinklers separate from other sprinklers.
- Protect the sprinklers during storage, transport, handling, and after installation.
- Use original shipping containers.
- Do not place sprinklers in loose boxes, bins, or buckets.

Installation of Wax-Coated Sprinklers:

Use only the special sprinkler head wrench designed for installing wax-coated Viking sprinklers (any other wrench may damage the unit).

- Take care not to crack the wax coating on the units.
- For touching up the wax coating after installation, wax is available from Viking in bar form. Refer to Table 1 below. The coating MUST be repaired after sprinkler installation to protect the corrosion-resistant properties of the sprinkler.
- Use care when locating sprinklers near fixtures that can generate heat. Do not install sprinklers where they would be exposed to temperatures exceeding the maximum recommended ambient temperature for the temperature rating used.
- Inspect the coated sprinklers frequently soon after installation to verify the integrity of the corrosion resistant coating. Thereafter, inspect representative samples of the coated sprinklers in accordance with NFPA 25. Close up visual inspections are necessary to determine whether the sprinklers are being affected by corrosive conditions.

TABLE 1

Sprinkler Temperature Rating (Fusing Point)	Wax Part Number	Wax Melting Point	Maximum Ambient Ceiling Temperature ¹	Wax Color
155 °F (68 °C) / 165 °F (74 °C)	02568A	148 °F (64 °C)	100 °F (38 °C)	Light Brown
175 °F (79 °C)	04146A	161 °F (71 °C)	150 °F (65 °C)	Brown
200 °F (93 °C)	04146A	161 °F (71 °C)	150 °F (65 °C)	Brown
220 °F (104 °C)	02569A	170 °F (76 °C)	150 °F (65 °C)	Dark Brown
286 °F (141 °C)	02569A	170 °F (76 °C)	150 °F (65 °C)	Dark Brown

¹ Based on NFPA-13. Other limits may apply, depending on fire loading, sprinkler location, and other requirements of the Authority Having Jurisdiction. Refer to specific installation standards.



Never install sprinklers that have been dropped, damaged, or exposed to temperatures in excess of the maximum ambient temperature allowed.

Refer to the appropriate current technical data pages for complete care, handling, and installation instructions. Data pages are included with each shipment from Viking or Viking distributors. They can also be found on the Web site at www.vikinggroupinc.com.

**BULLETIN****REGULATORY AND HEALTH
WARNINGS**

The Viking Corporation, 210 N Industrial Park Drive, Hastings MI 49058

Telephone: 269-945-9501 Technical Services: 877-384-5464 Fax: 269-818-1680 Email: techsvcs@vikingcorp.com

Visit the Viking website for the latest edition of this technical data page www.vikinggroupinc.com

1. DESCRIPTION

Regulatory and Health Warnings applying to materials used in the manufacture and construction of fire protection products are provided herein as they relate to legally mandated jurisdictional regions.

⚠ WARNING**STATE OF CALIFORNIA, USA**

Installing or servicing fire protection products such as sprinklers, valves, piping etc. can expose you to chemicals including, but not limited to, lead, nickel, butadiene, titanium dioxide, chromium, carbon black, and acrylonitrile which are known to the State of California to cause cancer or birth defects or other reproductive harm.

For more information, go to www.P65Warnings.ca.gov

2. WARRANTY TERMS AND CONDITIONS

For details of warranty, refer to Viking's current list price schedule at www.vikinggroupinc.com or contact Viking directly.



TECHNICAL DATA SHEET

VK3021 Quick Response Pendent Sprinkler K5.6 (80.6)

1. PRODUCT IDENTIFICATION

This document covers the following product, hereafter referred to as “sprinkler”:

VK3021: Quick Response, Standard Coverage, Pendent, K5.6 (80.6) Sprinkler.

2. INTENDED USE

The sprinkler is intended to be used in automatic fire sprinkler systems as allowed by applicable approval authorities. The sprinkler must be used in accordance with:

1. the sprinkler’s Listings, Approvals, and associated design requirements.
2. the recognized design and installations standards issued, for example NFPA, FM, EN, VdS, or LPCB.
3. the latest revisions of all applicable manufacturer’s documentation.

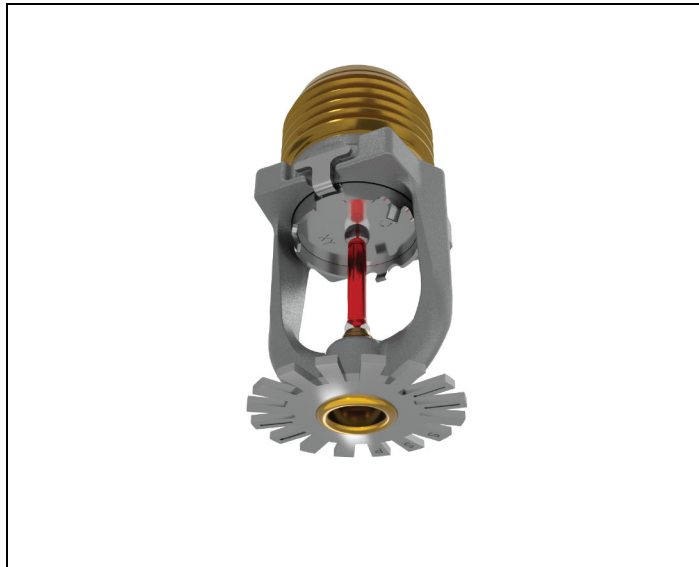

Governmental codes, ordinances, and standards may apply and may differ from one another.

WARNING

Cancer and Reproductive Harm www.P65Warnings.ca.gov

3. LISTING AND APPROVALS

Refer to section 5 for details and requirements that must be followed.



cULus Listed



VdS Approved



FM Approved



UKCA Approved



CE



MED Approved



LPCB Approved

China Approved

TECHNICAL DATA SHEET
**VK3021 Quick Response
Pendent Sprinkler K5.6 (80.6)**
4. TECHNICAL SPECIFICATIONS
4.1 Definitions

Standard Pendent Sprinkler: A sprinkler intended to be oriented with the deflector below the frame so water flows downward through the orifice, striking the deflector and forming an umbrella-shaped spray pattern downward. These sprinklers are marked “SP/RP” (Standard Pendent/Recessed Pendent). When a standard pendent sprinkler is used with a recessed escutcheon, it becomes a recessed pendent sprinkler.

Recessed Sprinkler: A spray sprinkler assembly intended for installation with a concealed piping system. The assembly consists of a sprinkler installed in a decorative adjustable recessed escutcheon that minimizes the protrusion of the sprinkler beyond the ceiling or wall without adversely affecting the sprinkler distribution or sensitivity. Refer to the appropriate technical data page for allowable sprinkler models, temperature ratings, and occupancy classifications.

NOTICE: Do not recess any sprinkler not listed or approved for use with the escutcheon. Refer to Section 5.

Corrosion-Resistant Sprinkler: A special service sprinkler with non-corrosive protective coatings, or that is fabricated from non-corrosive material, for use in atmospheres that would normally corrode sprinklers. Sprinklers can be ordered as corrosion-resistant sprinklers and can be used with escutcheons when allowed by the approval body.

4.2 Ratings and Physical Characteristics

Parameter	Value
Minimum operating pressure	7 psi (0.5 bar)
Maximum rated pressure	UL: 250 psi (17 bar) FM and CE: 175 psi (12 bar)
Factory tested pressure	500 psi (35 bar)
Thread size	1/2" NPT or 15 mm BSPT
Nominal K-factor	5.6 U.S. (80.6)
Minimum temperature rating (glass bulb)	-65 °F (-55 °C)

4.3 Markings and Dimensions

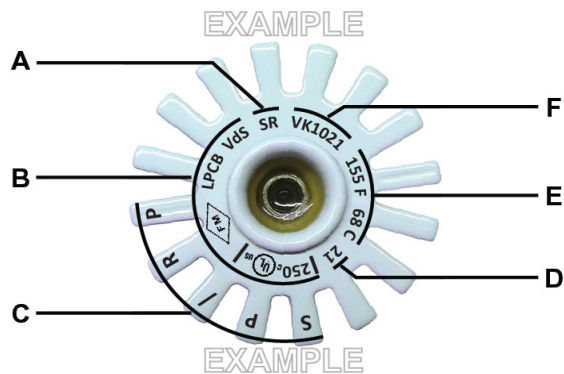

Figure – 1 Markings

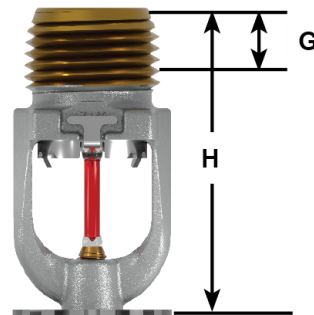

Figure – 2: Dimensions

Ref	Description	Value
A	Response type	QR: Quick Response
B	Listings and Approvals	See sections 3 and 5
C	Sprinkler type	SP/RP: Standard Pendent/Recessed Pendent
D	Manufacture date (year)	See marking
E	Nominal temperature rating	See marking
F	Manufacturers Sprinkler Identification Number (SIN)	VK3021
G	Nominal pipe engagement	7/16" (11 mm)
H	Height	1-15/16" (49 mm)

4.4 Materials of Construction

NOTICE: Do not disassemble the sprinkler.

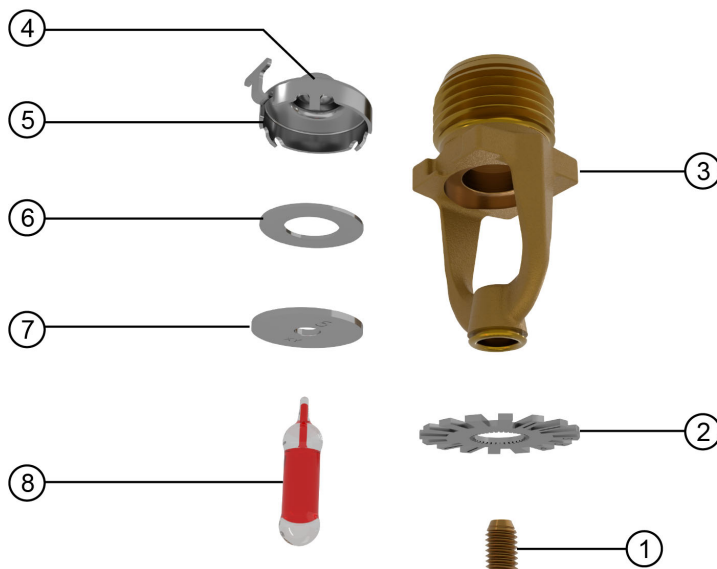

Figure – 3 Sprinkler Components

Ref	Description	Material
1	Compression screw	Brass CW612N, CW508L, UNS-C36000 or UNS-C26000
2	Deflector	Stainless steel UNS S30400
3	Sprinkler body	CW602N, UNS-C84400 or QM brass
4	Pip cap seal	Polytetrafluoroethylene (PTFE)
5	Pip cap shell	Stainless steel UNS-S44400
6	Belleville spring	Nickel alloy
7	Pip cap disc	Stainless steel UNS-S30100
8	Bulb	Glass, nominal 0.10" (3 mm) diameter

TECHNICAL DATA SHEET
**VK3021 Quick Response
Pendent Sprinkler K5.6 (80.6)**
5. LISTING AND APPROVAL DESIGN REQUIREMENTS
5.1 Listing and Approval Specifications

Sprinkler Base Part Number ¹	Thread Size		Approval Body							
	NPT	BSPT	cULus	FM	CE	LPCB	VdS	UKCA	MED	China
Maximum WWP PSI (bar) →			250 (17)		175 (12)					
23870	1/2"	—	A1, A2X, A3Y	A1, B2X, B3Y	A1, B2X, B3Y	A1, A2X, A3Y	A1	A1, A2X, A3Y	A1, A2X, A3Y	—
23882	—	15 mm	A1, A2X, A3Y	A1, B2X, B3Y	A1, B2X, B3Y	A1, A2X, A3Y	A1	A1, A2X, A3Y	A1, A2X, A3Y	—
26756	—	15 mm	C4	C4	—	—	—	—	—	C4

Approval Specification (Temperature Ratings) Key:

A = 135 °F (57 °C), 155 °F (68 °C), 175 °F (79 °C), 200 °F (93 °C) and 286 °F (141 °C)

B = 135 °F (57 °C), 155 °F (68 °C), 175 °F (79 °C), and 200 °F (93 °C)

C = 155 °F (68 °C), 175 °F (79 °C), 200 °F (93 °C) and 286 °F (141 °C)

Approval Specification (Finishes) Key:

1 = Brass, Chrome, White Polyester^{2,3}, Black Polyester^{2,3}, and ENT^{3,4}

2 = Brass, Chrome, White Polyester^{2,3}, and Black Polyester^{2,3}

3 = ENT^{3,4}

4 = Chrome

Approval Specification (Escutcheons) Key:

X = Installed with Viking Recessed Escutcheons Models E-1, E-2, E-3, NP-1, NP-2, and NP-3, or Viking Standard Surface Mounted Escutcheons

Y = Installed with Viking Recessed Escutcheons Models E-1 and NP-1, or Viking Standard Surface Mounted Escutcheons

¹ For complete part number, refer to Viking's current price list.

² For White Polyester and Black Polyester, other colors are available upon request and will carry the same Listings and Approvals as the standard colors.

³ cULus Listed as corrosion-resistant.

⁴ FM Approved as corrosion-resistant.

5.2 cULus Listing Requirements and Details

The sprinkler is cULus Listed as indicated in Table 5.1 for installation in accordance with the latest edition of NFPA 13 for standard spray sprinklers. This sprinkler is designed for use in light and ordinary hazard occupancies. Venting is not required.

5.3 FM Approval Requirements and Details

The sprinkler is FM Approved as quick response Non-Storage pendent sprinkler as indicated in the FM Approval Guide. The sprinkler is also approved for use in FM Approved vacuum dry sprinkler systems with a maximum supervisory vacuum pressure of -3 psi (-207 mbar). FM Global Loss Prevention Data Sheets contain guidelines relating to, but not limited to: minimum water supply requirements, hydraulic design, ceiling slope and obstructions, minimum and maximum allowable spacing, and deflector distance below the ceiling. For specific application and installation requirements, refer to the latest applicable FM Loss Prevention Data Sheets (including Data Sheet 2-0).



5.4 Additional Approval Requirements and Details

Refer to Table 5.1 for approved configurations allowed by each of the following approvals.

- CE CPR: Standard EN 12259-1:1999 +A3:2006; Declaration of Performance DOP_VK3021.
- LPCB: Standard EN 12259-1:1999 +A3:2006; Certificate Number 096m.
- VdS: Standard EN 12259-1:1999 +A3:2006; Certificate Number G 422006.
- UKCA: Standard EN12259-1:1999 +A3:2006; Declaration of Conformity UKCA DOC_S5048.
- MED: Standard EN 12259-1:1999 +A3:2006; Declaration of Conformity DOC_MED_XT1.
- China Approval: Approved according to China GB standard.

For specific application and installation requirements, refer to the latest applicable governmental codes, ordinances, and standards for the installation location.

5.5 Corrosion-Resistant Coatings

The corrosion-resistant coatings have passed the standard corrosion tests required by the approving agencies and are listed and approved as indicated in Table 5.1. These tests do not represent all possible corrosive environments. The Electro-less Nickel PTFE (ENT) finish passed the UL 199 thirty-day corrosion test and is cULus listed and FM Approved as corrosion-resistant. For automatic sprinklers, the ENT coating is applied to all exposed exterior surfaces, including the waterway.

Prior to installation, verify that the coatings are compatible with, or suitable for, the proposed environment. The ENT finish has not been evaluated for environments containing chlorine, such as indoor swimming pools. It is not recommended for these applications.

5.6 Sprinkler Guards and Water Shields

The sprinkler is approved for use with the Model XG Sprinkler Guard and the Model F-1 water shield. Refer to the Guards and Water Shields for XT1 Sprinklers technical data sheet for more information.

5.7 Escutcheons

The sprinkler is approved for use with various styles of Viking escutcheons. Specific installation dimensions apply that must be observed. Refer to the sprinkler's Handling and Installation instructions for more information.

5.8 Available Temperature Ratings

Viking sprinklers are available in several temperature ratings that relate to a specific temperature classification. Applicable installation rules mandate the use and limitations of each temperature classification. In selecting the appropriate temperature classification, the maximum expected ceiling temperature must be known. When there is doubt as to the maximum temperature at the sprinkler location, a maximum-reading thermometer should be used to determine the temperature under conditions that would show the highest readings to be expected. In addition, recognized installation rules may require a higher temperature classification, depending upon sprinkler location, occupancy classification, commodity classification, storage height, and other hazards. In all cases, the maximum expected ceiling temperature dictates the lowest allowable temperature classification. Sprinklers located immediately adjacent to a heat source may require a higher temperature rating.

TECHNICAL DATA SHEET
**VK3021 Quick Response
Pendent Sprinkler K5.6 (80.6)**
6. ORDERING PROCEDURE
6.1 Sprinkler

1. Choose a sprinkler base part number with the required thread size and listing or approval (refer to section 5):
2. Add the suffix for the desired finish.
3. Add the suffix for the desired temperature rating.

NOTE: For Polyester, insert the desired temperature rating suffix where the dash (-) is shown.

EXAMPLE: 23870MB/W = VK3021 with white polyester finish and 155 °F (68 °C) nominal temperature rating. This sprinkler is to be installed into an area with a maximum ambient temperature of 100 °F (38 °C).

1. Sprinkler Base Part Number		2. Finish		3. Temperature Rating			
See Section 5		Description	Suffix	Nominal Temperature Rating	Bulb Color	Maximum Ambient Ceiling Temperature	Suffix
23870	1/2" NPT	Brass	A	135 °F (57 °C)	Orange	100 °F (38 °C)	A
23882	15 mm BSPT	Chrome	F	155 °F (68 °C)	Red	100 °F (38 °C)	B
26756*	15 mm BSPT	White Polyester	M-/W	175 °F (79 °C)	Yellow	150 °F (65 °C)	D
		Black Polyester	M-/B	200 °F (93 °C)	Green	150 °F (65 °C)	E
		ENT	JN	286 °F (141 °C)	Blue	225 °F (107 °C)	G
				OPEN	—	—	Z

*Only for China

6.2 Sprinkler Accessories



Figure – 4: Sprinkler Accessories

Image Reference	Part Number	Description
1)	23559MB	Straight wrench: required for proper installation
2)	23560MB	Recessed socket wrench
3)	01724A	Sprinkler cabinet: holds up to 6 sprinklers
4)	01725A	Sprinkler cabinet: holds up to 12 sprinklers (not shown)
5)	06419A	Model E-1 Slip-on style recessed escutcheon
	07902	Model E-1 Slip-on style recessed escutcheon (stainless steel)
6)	11038	Model E-2 Threaded recessed escutcheon
7)	18347	Model E-3 Threaded recessed escutcheon (large diameter outer cup)
8)	01960A	Large standard flat surface mount escutcheon (steel)
	09488	Large standard flat surface mount escutcheon (stainless steel)
9)	02960A	Small standard flat surface mount escutcheon (steel)
	07526	Small standard flat surface mount escutcheon (stainless steel)
10)	01961B	Large standard raised surface mount escutcheon (brass)

TECHNICAL DATA SHEET
**VK3021 Quick Response
Pendent Sprinkler K5.6 (80.6)**
7. CONTACT

The sprinkler and accessories are available through Viking distributors only. Contact your local Viking sales office which can be found on our website:

Americas and Asia: www.vikinggroupinc.com/locations OR Europe, Middle East, Africa (EMEA): www.viking-emea.com/contact

Manufacturer:

The Viking Corporation
5150 Beltway SE
Caledonia, MI 49316
Tel.: (800) 968-9501
Fax: 269-818-1680
Technical Services: 1-877-384-5464
techsvcs@vikingcorp.com

Importer EU:

Viking S.A.
21, Z.I, Haneboesch
L-4562 Differdange / Niederkorn
Tel.: +352 58 37 37 – 1
Fax: +352 58 37 36
vikinglux@viking-emea.com

Asia Pacific (APAC) Main Office:

The Viking Corporation (Far East) Pte. Ltd.
69 Tuas View Square
Westlink Techpark, Singapore 637621
Tel: (+65) 6 278 4061
Fax: (+65) 6 278 4609
vikingAPAC@vikingcorp.com



Handling and Installation Instructions

Model XT-1 Pendent Sprinklers

	bg	Инсталирайте и пуснете продукта в експлоатация само ако следната инструкция е ясно разбрана.	lv	Produkta iemontēšanu un ekspluatācijas sākšanu veikt tikai tad, ja dotā instrukcija ir pilnībā saprasta.
	cs	Namontujte a spusťte do provozu produkt pouze tehdy, když jste jasně pochopili tento návod.	lt	Produktą montuokite ir pradėkite eksploatuoti tik tuomet, jei aiškiai suprantate šią instrukciją.
	de	Du må kun montere og idriftsætte produktet, hvis du har forstået følgende vejledning til fulde.	mt	Installa u f'ad dem il-prodott biss jekk l-istruzzjonijiet li ġejjin jinftiehm b'mod ċar.
	de	Produkt nur einbauen und in Betrieb nehmen, wenn die nachfolgende Anleitung klar verstanden wird.	nl	Product alleen installeren en in gebruik nemen, als de volgende instructies begrepen zijn.
	el	Η εγκατάσταση και θέση σε λειτουργία του προϊόντος επιτρέπονται μόνο εάν οι ακόλουθες οδηγίες έχουν γίνει κατανοητές.	no	Ikke installer og ta i bruk produktet uten at følgende anvisninger er tydelig forstått.
	en	Do not install and commission the product unless you have clearly understood the instructions below.	pl	Produkt należy montować i uruchamiać tylko wtedy, gdy poniższe instrukcje są w pełni zrozumiałe.
	es	Instalar el producto y ponerlo en funcionamiento solo cuando se hayan comprendido claramente las siguientes instrucciones.	pt	Instalar e colocar o produto em funcionamento somente se as instruções a seguir forem claramente compreendidas.
	et	Paigaldage toode ja kasutage seda ainult siis, kui saate alljärgnevast juhendist selgelt aru.	ro	Montați produsul și puneți-l în funcțiune numai dacă instrucțiunea următoare este înțeleasă clar.
	fi	Tuotteen saa asentaa ja ottaa käyttöön vain, jos jäljempänä oleva ohje ymmärretään selvästi.	ru	Не устанавливайте и не принимайте оборудование в эксплуатацию, если вы четко не поняли инструкции ниже
	fr	N'installer et ne mettre en service le produit que si les instructions suivantes ont été clairement comprises.	sk	Namontujte a spusťte do prevádzky výrobok iba vtedy, pokiaľ ste jasne pochopili tento návod.
	ga	Ná déan an táirge a shuiteail agus a choimisiúnu mura dtuigeann tu na teoracha thíos go soiléir.	sl	Izdelek vgradite in zaženite samo, če ste dobro razumeli navodila v nadaljevanju.
	hr	Ne instalirajte i ne puštajte proizvod u rad ako niste jasno razumjeli donje upute.	sr	Не инсталирајте и не пуштајте производ у рад ако нисте јасно разумели упутства у наставку.
	hu	Csak akkor építse be a terméket és helyezze üzembe, ha a következő útmutatót egyértelműen megértette.	sv	Montera och driftsätt produkten endast om du förstår den efterföljande instruktionen.
	is	Settu ekki upp eða taktu vöruna í notkun nema þú hafir skilið greinilega leiðbeiningarnar hér að neðan.	tr	Aşağıdaki talimatları açıkça anlamadan ürünü kurmayın ve devreye almayın.
it	Montare il prodotto e metterlo in funzione solo se si sono comprese appieno le seguenti istruzioni.			

1. PRODUCT IDENTIFICATION

This document covers the following products, hereafter referred to as “sprinkler”:

- VK1021 Standard Response Pendent Sprinkler K5.6 (80.6)
- VK2021 Standard Response Pendent Sprinkler K8.0 (115)
- VK2022 Standard Response Pendent Sprinkler K8.0 (115)
- VK3021 Quick Response Pendent Sprinkler K5.6 (80.6)
- VK3521 Quick Response Pendent Sprinkler K8.0 (115)
- VK3522 Quick Response Pendent Sprinkler K8.0 (115)

2. OTHER APPLICABLE DOCUMENTS

For intended use and relevant conditions for the safe use of the specific sprinkler refer to the appropriate *Technical Data Sheet*.



3. TRANSPORT AND HANDLING

WARNING

A damaged or compromised sprinkler poses the risk of fatal consequences.

Damaged or compromised sprinklers will not operate properly which could lead to loss of life.

- NEVER use a sprinkler that has been exposed to temperatures exceeding the maximum allowed ambient temperature.
- NEVER use a sprinkler with a loss of liquid from the glass bulb or damage to the fusible element. A small bubble should be visible within the glass bulb; rotate the sprinkler to a horizontal position while observing the bulb to see the bubble.
- NEVER use a sprinkler that has been dropped or damaged.
- ALWAYS Protect the sprinkler from mechanical damage during storage, transport, and handling.
- NEVER use sprinklers that have been painted by anyone other than the manufacturer.
- ALWAYS protect sprinklers from being painted during installation or replacement in accordance with the installation standards.
- NEVER clean sprinklers with anything other than 7 psi or lower compressed air.
- NEVER apply soap, water, ammonia, adhesives, solvents or any other fluids on sprinklers.
- Destroy every damaged or compromised sprinkler.

NOTICE

Protect sprinklers during transport and handling.

- ALWAYS handle the sprinkler with care.
- ALWAYS keep the protective cap on the sprinkler during transport and handling.
- NEVER remove the protective cap until the fire sprinkler system is placed in service and the potential for mechanical damage no longer exists.
- ALWAYS protect the sprinkler from direct sunlight during transport and handling.
- ALWAYS store sprinkler in a cool, dry, protected area.
- ALWAYS use original manufacturer's shipping containers.
- NEVER store a sprinkler loose in a box, bin, bucket, or other type of container.
- ALWAYS keep the sprinkler separated from other sprinklers.
- NEVER allow metal parts to contact the sprinkler operating elements.

NOTE: If the glass bulb included on the sprinkler has been exposed to ultraviolet light, the color inside the bulb may fade. This color change does not affect the operation of the sprinkler.

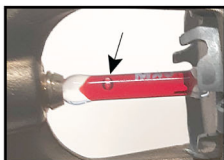

CORRECT
(Bulb intact, bubble visible)



INCORRECT
(bulb cracked, fluid missing)



CORRECT
(Protective caps in place)



INCORRECT
(Protective caps not in place)



CORRECT
Container



INCORRECT
(Stored loose in a box)

4. INSTALLATION

⚠ WARNING

Installation by insufficiently qualified personnel poses the risk of fatal consequences.

- This sprinkler must be installed properly by qualified personnel familiar with safe practices and applicable and recognized design and installation standards issued, for example, by NFPA, FM, VdS, or LPCB, and trained how to properly perform the installation procedures.

⚠ WARNING

Incorrect recessed installation poses the risk of fatal consequences.

- For recessed applications, this sprinkler must be installed according to the dimensions shown in Figure 1.

⚠ CAUTION

Cutting Hazard.

Sprinklers, accessories, cabinets, and packaging can have sharp edges that can cause cuts.

- Wear appropriate personal protective equipment (gloves) while handling product.

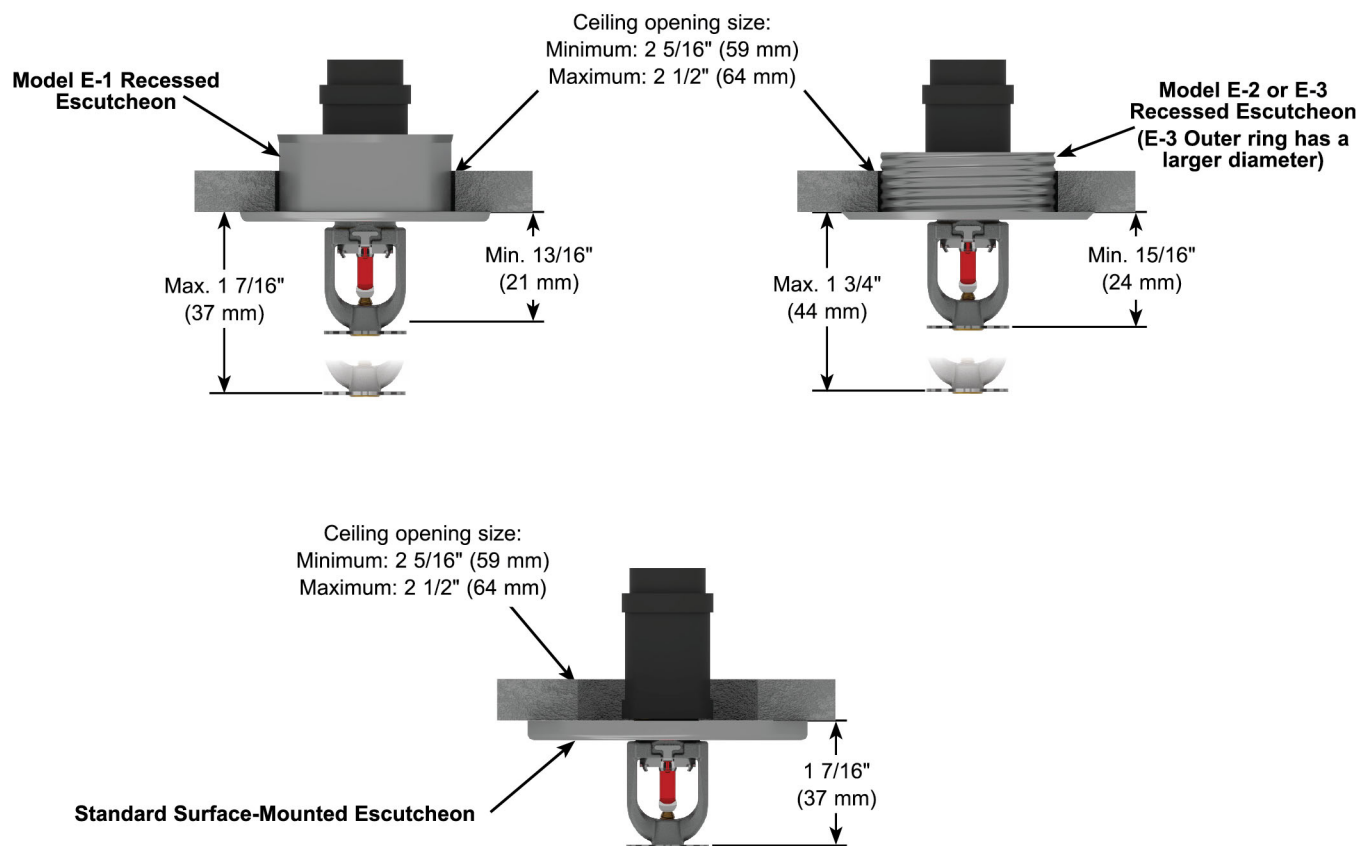

Figure – 1 Installation Dimensions with Viking Escutcheons

Optional Guards, Shields, and Escutcheons: If the sprinkler shall be installed together with a guard, shield, or escutcheon refer to the applicable documents for the products used.

1. Install all required piping in the intended installation location.
2. Verify that the sprinkler model/style, K-factor, temperature rating, and response characteristics are appropriate for the intended installation location. See Table 1 and Figure 5.
3. Inspect the sprinkler for damage. Destroy every damaged or compromised sprinkler. The following are examples in which sprinklers are considered damaged or compromised. Replace the sprinkler in the following cases:
 - Sprinkler with a loss of fluid from the glass bulb or damage to the fusible element.
 - Sprinklers that have been field painted, caulked, or mechanically damaged.
 - Sprinklers showing signs of corrosion.
4. Verify that the sprinkler is protected with the protective cap or clip.
5. Apply a small amount of pipe-joint compound or tape to the external threads of the sprinkler only. Do not allow a build-up of compound inside the sprinkler inlet (Figure 2).

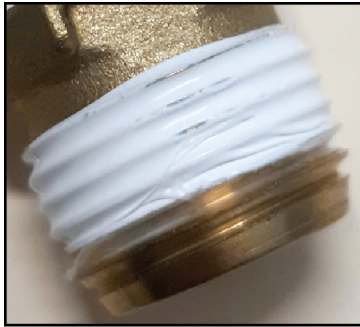

Figure – 2

6. If applicable, Install the escutcheon on the sprinkler threads.
7. **NOTICE: Do not use the deflector to start threading the sprinkler into a fitting. Use ONLY the approved wrench to install the sprinkler. Refer to the sprinkler's *Technical Data Sheet*.**
 - a) **For recessed sprinkler wrench (Figure 3a):** Carefully slide the wrench sideways around the protective cap and push upwards to engage with the sprinkler wrench flats.
 - b) **For the standard sprinkler wrench (Figure 3b):** Carefully slide the wrench onto the sprinkler wrench flats.

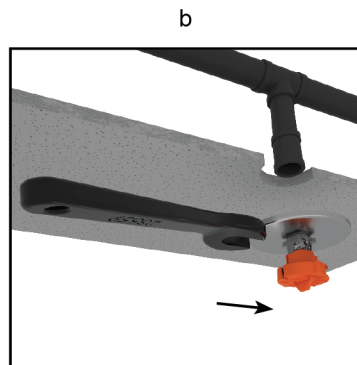
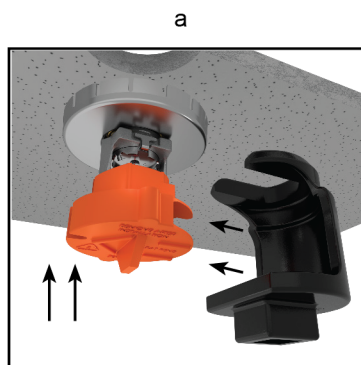



Figure – 3

	Handling and Installation Instructions	Model XT-1 Pendent Sprinklers
---	---	--------------------------------------

8. **NOTICE: Over-tightening the sprinkler can cause permanent damage. For 1/2" NPT (or 15 mm BSPT) sprinkler, tighten up to a maximum torque of 14 ft-lbs (19 Nm). For 3/4" NPT (or 20 mm BSPT) sprinkler, tighten up to a maximum of 20 ft-lbs (27,1 Nm).**
Tighten the sprinkler as necessary (Figure 4a and 4b). If applicable, install a sprinkler guard and water shield.

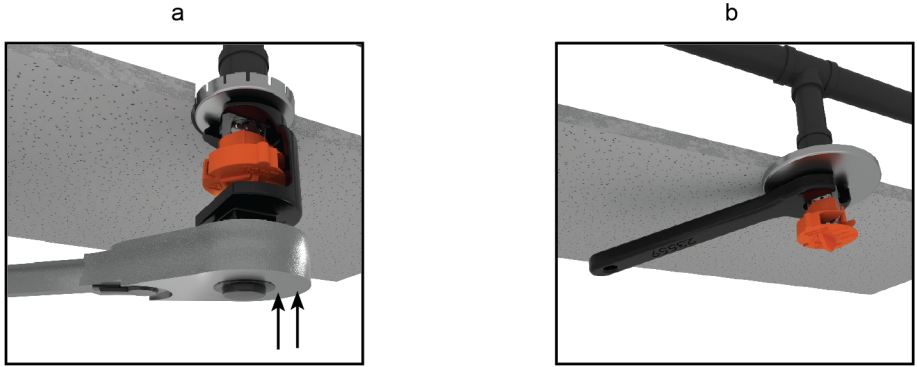

Figure – 4

9. **NOTICE: Sprinkler protective caps/clips must be removed from the sprinkler before placing the system in service. Test the entire sprinkler system.**
Refer to the applicable system documentation, regulations, and standards to ensure compliance.

Table 1: Sprinkler Markings		
Ref	Parameter	
A	Response type	 <p style="text-align: center;">EXAMPLE</p> <p style="text-align: center;">EXAMPLE</p>
B	Listings and approvals	
C	Sprinkler type	
D	Manufacture date	
E	Nominal temperature rating	
F	Manufacturer's Sprinkler Identification Number (SIN)	

Figure – 5



Handling and Installation Instructions

Model XT-1 Pendent Sprinklers

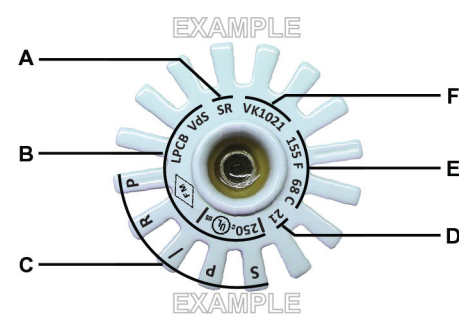
5. CONTACT

The sprinkler and accessories are available through Viking distributors only. Contact your local Viking sales office which can be found on our website:

Americas and Asia: www.vikinggroupinc.com/locations OR Europe, Middle East, Africa (EMEA): www.viking-emea.com/contact

Manufacturer:

The Viking Corporation
5150 Beltway SE
Caledonia, MI 49316
Tel.: (800) 968-9501
Fax: 269-818-1680
Technical Services: 1-877-384-5464
techsvcs@vikingcorp.com

Importer EU:

Viking S.A.
21, Z.I, Haneboesch
L-4562 Differdange / Niederkorn
Tel.: +352 58 37 37 – 1
Fax: +352 58 37 36
vikinglux@viking-emea.com

Asia Pacific (APAC) Main Office:

The Viking Corporation (Far East) Pte. Ltd.
69 Tuas View Square
Westlink Techpark, Singapore 637621
Tel: (+65) 6 278 4061
Fax: (+65) 6 278 4609
vikingAPAC@vikingcorp.com



1. PRODUCT IDENTIFICATION

This document covers the following product, hereafter referred to as “sprinkler” (SR=Standard Response, QR=Quick Response):

- VK1001 SR Upright Sprinkler K5.6 (80.6)
- VK2001 SR Upright Sprinkler K8.0 (115)
- VK2002 SR Upright Sprinkler K8.0 (115)
- VK3001 QR Upright Sprinkler K5.6 (80.6)
- VK3501 QR Upright Sprinkler K8.0 (115)
- VK3502 QR Upright Sprinkler K8.0 (115)
- VK1021 SR Pendent Sprinkler K5.6 (80.6)
- VK2021 SR Pendent Sprinkler K8.0 (115)
- VK2022 SR Pendent Sprinkler K8.0 (115)
- VK3021 QR Pendent Sprinkler K5.6 (80.6)
- VK3521 QR Pendent Sprinkler K8.0 (115)
- VK3522 QR Pendent Sprinkler K8.0 (115)
- VK1181 SR Conventional Sprinkler K5.6 (80.6)
- VK1201 SR Conventional Sprinkler K8.0 (115)
- VK1202 SR Conventional Sprinkler K8.0 (115)
- VK3101 QR Conventional Sprinkler K5.6 (80.6)
- VK3541 QR Conventional Sprinkler K8.0 (115)
- VK3542 QR Conventional Sprinkler K8.0 (115)

WARNING

Cancer and Reproductive Harm www.P65Warning.ca.gov

2. OTHER APPLICABLE DOCUMENTS

For intended use and relevant conditions for the safe use of the specific sprinkler, refer to the appropriate Technical Data Sheet. In case an installed sprinkler needs to be replaced, refer to the appropriate Handling and Installation Instructions for the installation of the new sprinkler.

3. MAINTAINING OPERATIONAL READINESS

Functionality

During fire conditions, the operating element fuses or shatters (depending on the type of sprinkler), releasing the pip cap and sealing assembly. Water flowing through the sprinkler orifice strikes the sprinkler deflector, forming a uniform spray pattern to control or extinguish the fire.

WARNING

This section contains important safety information. Read and follow all information.

Damaged or Compromised Sprinklers

Damaged or compromised sprinklers will not operate properly which could lead to loss of life.

- NEVER clean, paint, or caulk sprinklers.
- NEVER apply soap, water, ammonia, adhesives, solvents or any other fluids on sprinklers.
- NEVER expose sprinklers to temperatures exceeding the maximum allowed ambient ceiling temperature. See the Technical Data Sheet.
- ALWAYS replace a compromised or damaged sprinkler.
- NEVER attempt to repair or reassemble a sprinkler.
- ALWAYS replace operated sprinklers and cover assemblies and sprinklers exposed to corrosive products of combustion.
- Replacement of sprinklers must only be performed following the instructions in section 4.

The following are examples in which sprinklers are considered damaged or compromised. Replace the sprinkler in the following cases:

- Sprinkler with a loss of fluid from the glass bulb or damage to the fusible element.
- Sprinklers or cover plate assemblies that have been field painted, caulked, or mechanically damaged.
- Sprinklers showing signs of extraordinary corrosion.



Obstructions and obstacles

Obstructions and obstacles may compromise sprinkler discharge patterns which are critical for proper fire protection.

- NEVER attach items to sprinklers or hang items from the ceiling in an area protected with sprinklers.
- NEVER install walls in areas protected with sprinklers without having a specialized company verifying the design of the sprinkler system.
- ALWAYS remove obstructions and obstacles to sprinkler spray patterns.

Sprinkler systems that have been subjected to a fire

Sprinkler systems that have been subjected to a fire must be returned to service as soon as possible.

- After an event of fire, the entire sprinkler system must be inspected for damage and repaired as necessary.
- Refer to the minimum requirements of the Authority Having Jurisdiction for replacement of sprinklers.
- Consider the employment of a fire patrol as long as the sprinkler system is out of service.

Inspections and testing

The owner is responsible for having the sprinklers inspected and tested according to standards of the applicable approval body and to the requirements of the Authority Having Jurisdiction to maintain proper operating condition of the system.

- Sprinklers must be inspected on a regular basis for corrosion, mechanical damage, obstructions, paint, etc. Frequency of inspections may vary due to corrosive atmospheres, water supplies, and activity around the sprinkler.

The applicable approval body or Authority Having Jurisdiction may require sprinklers to be replaced after a specified term of service.

- Refer to the standards of the applicable approval body, such as NFPA, FM, VdS, or LPCB, and the requirements of the Authority Having Jurisdiction for detailed inspection, testing and replacements requirements.

Sprinklers removed from the system for testing or for any other purpose must be replaced according to section 4.

4. REMOVAL AND REPLACEMENT

WARNING

Removal and replacement of sprinklers by insufficiently qualified personnel poses the risk of fatal consequences in case of fire.

- Removal or replacement of sprinklers must be performed by qualified personnel familiar with safe practices and applicable and recognized design and installation standards issued, for example, by NFPA, FM, VdS, or LPCB, and trained how to properly perform the installation procedures.

WARNING

Removal and replacement of sprinklers will temporarily eliminate the fire protection capabilities of the sprinkler system.

- Consider the employment of a fire patrol in the affected area.
- Prior to proceeding, notify all Authorities Having Jurisdiction.

⚠ WARNING

Re-installation of a removed sprinkler may compromise the operational safety of the sprinkler system.

- NEVER reinstall a removed sprinkler.
 - ALWAYS use new sprinklers for replacement.
1. Select new sprinklers with identical performance characteristics as well as respective accessories such as escutcheons, cover plates, and protective caps. A stocked spare sprinkler cabinet may be provided for this purpose on site.
 2. According to appropriate system description and/or valve instructions, remove the system from service, drain all water, and relieve all pressure on the piping.
 3. Only for flush and concealed style sprinklers: Remove the ceiling ring or cover plate assembly of the old sprinkler by gently unthreading or pulling it off the sprinkler body (depends on the sprinkler model used).
 4. Use the proper sprinkler wrench for the old sprinkler according to its Technical Data Sheet.
 5. Only for flush and concealed style sprinklers, but not for domed concealed sprinklers: Replace the plastic protective cap over the old sprinkler and fit the wrench over the cap.
 6. Use the wrench to remove the old sprinkler by turning it counterclockwise to unthread it from the piping.
 7. Install the new sprinkler by following its Handling and Installation Instructions.
 8. Place the system back in service and secure all valves.
 9. Check for and repair all leaks.

5. DISPOSAL

At end of use the product described here should be disposed of via the national recycling system.

6. CONTACT

The sprinkler and accessories are available through Viking distributors only. Contact your local Viking sales office which can be found on our website:

Americas and Asia: www.vikinggroupinc.com/locations OR Europe, Middle East, Africa (EMEA): www.viking-emea.com/contact

Manufacturer:

The Viking Corporation
5150 Beltway SE
Caledonia, MI 49316
Tel.: (800) 968-9501
Fax: 269-818-1680
Technical Services: 1-877-384-5464
techsvcs@vikingcorp.com

Importer EU:

Viking S.A.
21, Z.I, Haneboesch
L-4562 Differdange / Nieder Korn
Tel.: +352 58 37 37 – 1
Fax: +352 58 37 36
vikinglux@viking-emea.com

Asia Pacific (APAC) Main Office:

The Viking Corporation (Far East) Pte. Ltd.
69 Tuas View Square
Westlink Techpark, Singapore 637621
Tel: (+65) 6 278 4061
Fax: (+65) 6 278 4609
vikingAPAC@vikingcorp.com

Ultra SprinkFlex® Hose Fig. HB1

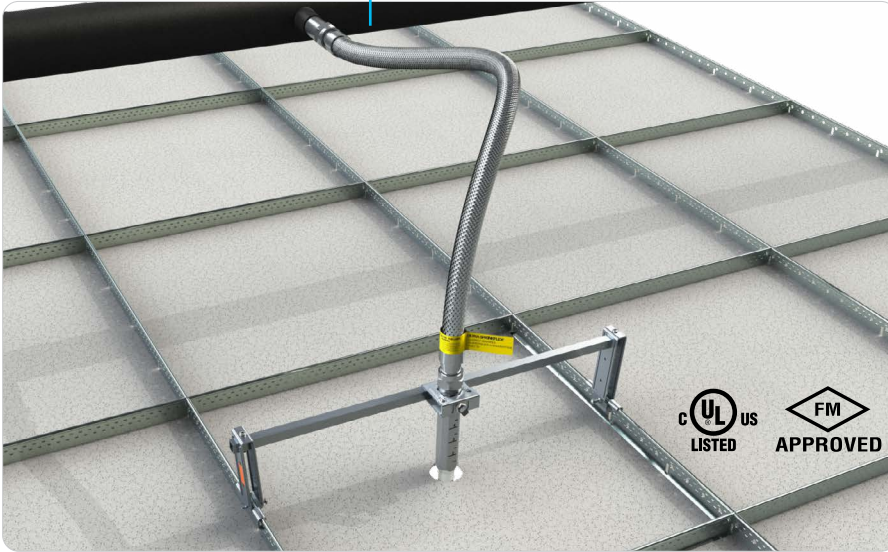

Fig. HB1 and HB1C Brackets

Bracket Fig # & Size	cULus Listed	FM Approved	SprinkFlex Historical Model Number
BKT-IPT, 24in	✓	✓	IPT-24-BKT1
BKT-IPT, 48in			IPT-48-BKT1
BKT-SFO-4, 24in		✓	SFO24BKT1
BKT-SFO-4, 48in		✓	SFO48BKT1

Product Specifications

HB1 Standard Assembly*

28in	59in
40in	71in
48in	

*Comes standard with 7" Long Straight Drop and Threaded Inlet Nipple

HB1C Inlet Nipple Component

Elbow Fitting

Pressure Rating

UL: 175psi (1,205kPa)

FM: 175psi (1,205kPa)

Minimum Bend Radius

UL: 2.0in (50.8mm)

FM: 7.0in (177.8mm)

Ambient Temperature

225°F (107°C) Max

Material

304 Stainless Steel Hose, Carbon Steel Fittings

Features

- Modular design for custom installations
- No bend radius inspection required for cULus applications
- Pre-Installed Sprinkler Head option available upon request
- Every hose comes with an easy to identify Yellow Tag

Ordering

Specify figure number, length, outlet size, & description. Fig. HB1C Components sold separately.

Note

SprinkFlex Historical Model Numbers may be used to verify cULus Listings & FM Approvals.



PROJECT INFORMATION	APPROVAL STAMP
Project:	Approved
Address:	Approved as noted
Contractor:	Not approved
Engineer:	Remarks:
Submittal Date:	
Notes 1:	
Notes 2:	

Ultra SprinkFlex® Hose Fig. HB1

Standard Assembly: HB1C Threaded Inlet & HB1C 7" Long Drop

Fig. HB1 Assembly cULus Listing per UL 2443 & FM Approval (Listing) per FM 1637

Outlet Size	Assembly Length	Equivalent Length				Max # of 90° Bends	
		UL		FM		UL	FM
	In	ft	m	ft	m	#	#
½ NPS	28	16	4.9	14.5	16.8	4	1
	40	20	6.1	20.8	6.3	5	2
	48	34	10.4	22.4	6.8	8	3
	59	44	13.7	31.4	9.6	10	3
	71	56	16.8	36.3	11.1	12	4
¾ NPS	28	15	4.6	14.4	4.4	4	1
	40	23	7	20.7	6.3	5	2
	48	34	10.4	22.3	6.8	8	3
	59	48	14.6	31.3	9.5	10	3
	71	56	16.8	36.2	11	12	4

1. HB1 Standard Assembly comes with the 1" NPT Threaded Inlet Nipple & 7" Long Straight Outlet Drop.
2. Equivalent Length of NPS 1 (DN25) Sch 40 Pipe.
3. Equivalent Lengths listed above assume the maximum number of 90° bends.
4. A 90° bend can be achieved with two 45° bends or three 30° bends.
5. UL & FM Equivalent Lengths are listed for installation with sprinklers with a maximum k-factor of 16.8.

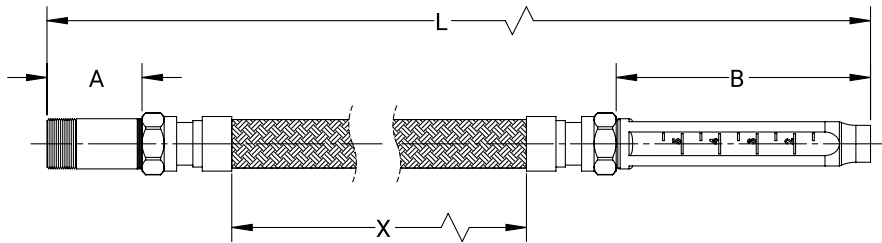

Fig. HB1 Standard Assembly Dimensions & Model Number

Assembly Length	True Length (L)		Braid Length (X)		Inlet Nipple Length (A)		Outlet Drop Length (B)		SprinkFlex Historical Model Number	
	In	mm	In	mm	In	mm	In	mm	½ NPS Outlet	¾ NPS Outlet
28	27.6	700	14.4	365					HB1-28-LDRP-H	HB1-28-LDRP-T
40	39.4	1000	25.4	644					HB1-40-LDRP-H	HB1-40-LDRP-T
48	47.2	1200	33.4	847	2.50	63.5	6.75	171.5	HB1-48-LDRP-H	HB1-48-LDRP-T
59	59.1	1500	45.4	1152					HB1-59-LDRP-H	HB1-59-LDRP-T
71	70.9	1800	57.4	1457					HB1-71-LDRP-H	HB1-71-LDRP-T



asc-es.com

Building connections that last™

Ultra SprinkFlex® Hose Fig. HB1

Elbow Assembly: HB1C Threaded Inlet, HB1C Elbow Fitting, & HB1C 7" Long Drop

Fig. HB1 Assembly cULus Listing per UL 2443 & FM Approval (Listing) per FM 1637

Outlet Size	Assembly Length	Equivalent Length				Max # of 90° Bends	
		UL		FM		UL	FM
		ft	m	ft	m	#	#
½ NPS	28	18	5.5	18.5	5.6	4	1
	40	22	6.7	24.6	7.5	5	2
	48	36	11.0	26.4	8.0	8	3
	59	46	14.0	35.4	10.8	10	3
	71	-	-	40.3	12.3	12	4
¾ NPS	28	17	5.2	18.4	5.6	4	1
	40	25	7.6	24.5	7.5	5	2
	48	36	11.0	26.3	8.0	8	3
	59	48	15.0	35.3	10.8	10	3
	71	-	-	40.2	12.3	12	4

1. HB1 Assembly with the 1" NPT Threaded Inlet Nipple, 7" Long Straight Outlet Drop, & Elbow Fitting. HB1C Elbow Fitting sold separately and installed per Installation Instructions.
2. Equivalent Length of NPS 1 (DN25) Sch 40 Pipe.
3. Equivalent Lengths listed above assume the maximum number of 90° bends.
4. A 90° bend can be achieved with two 45° bends or three 30° bends.
5. UL & FM Equivalent Lengths are listed for installation with sprinklers with a maximum k-factor of 16.8.

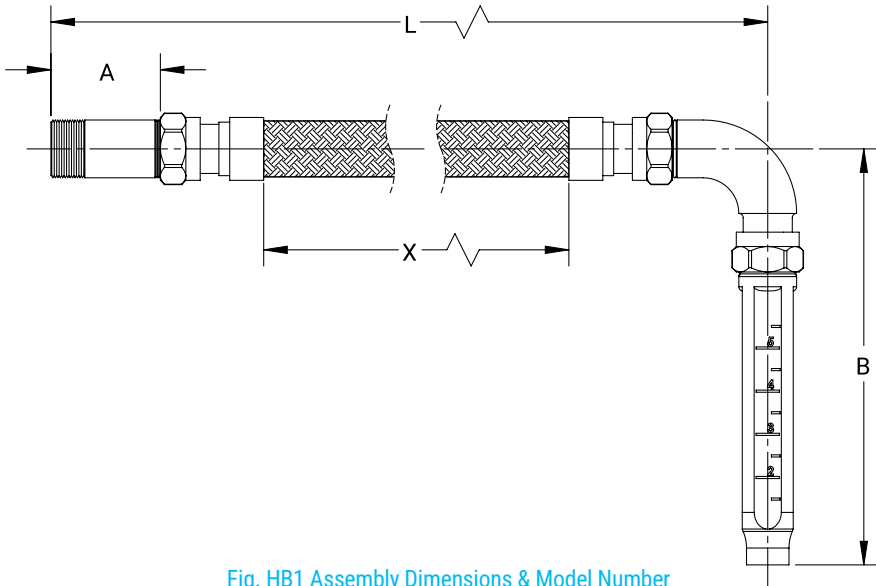

Fig. HB1 Assembly Dimensions & Model Number

Assembly Length	True Length (L)		Braid Length (X)		Inlet Nipple Length (A)		Outlet Drop Length (B)		SprinkFlex Historical Model Number	
	In	mm	In	mm	In	mm	In	mm	½ NPS Outlet	¾ NPS Outlet
28	23.0	585	14.4	365	-	-	-	-	HB1CE-28-LDRP-H	HB1CE-28-LDRP-T
40	34.8	884	25.4	644	-	-	-	-	HB1CE-40-LDRP-H	HB1CE-40-LDRP-T
48	42.6	1083	33.4	847	2.50	63.5	9.75	247.4	HB1CE-48-LDRP-H	HB1CE-48-LDRP-T
59	54.5	1385	45.4	1152	-	-	-	-	HB1CE-59-LDRP-H	HB1CE-59-LDRP-T
71	66.3	1685	57.4	1457	-	-	-	-	-	-

Ordering: HB1 Assembly with the desired hose length, HB1C Elbow Fitting



asc-es.com

Building connections that last™

Ultra SprinkFlex® Hose Fig. HB1

Threaded Connection to the Branch (HB1C Threaded Inlet)

1. Separate the threaded inlet nipple (if necessary) from the flexible hose. Apply pipe sealant or tape to the NPT thread on the threaded inlet nipple and install into the branch outlet. **Note:** Only place the pipe wrench on the unthreaded portion of the inlet nipple.
2. Examine the O-ring in the threaded hex union attached to the end of the hose. Ensure it is seated properly and free of debris.
3. Ensure the arrow on the hose is pointing in the direction of flow. Tighten the threaded hex union at the end of the braided hose to the inlet nipple. Hand tight plus ½ turn (15ft-lbs).

Bending the Hose

1. The hose may be bent to ensure the inlet nipple and outlet drop are in the desired locations.
2. The hose should never be bent to a radius less than minimum listed bend radius. The bend radius is defined to the center of the hose.
3. The hose must have at least one 90° bend. A 90° bend can be achieved with two 45° bends or three 30° bends.
4. For best performance, the bends in the hose should be as large and smooth as possible.

Connection to the Bracket

1. Installation of the outlet drop to the bracket shall be per the bracket's installation instructions. The bracket shall be listed for installation with the HB1. See Page 1 for Listed and Approved brackets.
2. Examine the O-ring in the threaded hex union attached to the end of the hose. Ensure it is seated properly and free of debris.
3. Tighten the threaded hex union at the end of the braided hose to the outlet drop. Hand tight plus ½ turn (15ft-lbs)

Connection to the Sprinkler Head

1. Installation of the sprinkler head into the outlet drop shall be per the sprinkler manufacturer's installation instructions.

General Installation Notes

1. Never apply a wrench to the braided hose.
2. The Fig HB1 may be installed in any direction from the branch.
3. If installing a sprinkler to the hose after installation to the bracket, it is best practice to prevent twisting of the bracket and hose by holding the outlet drop with a wrench.



asc-es.com

Building connections that last™

Fire Sprinkler Pipe

Schedule 10 and Schedule 40

Submittal Data Sheet



FM Approved and Fully Listed Sprinkler Pipe

Wheatland's Schedule 10 and Schedule 40 steel fire sprinkler pipe is FM Approved and UL, C-UL and FM Listed.

Approvals and Specifications

Both products meet or exceed the following standards:

- ASTM A135, Type E, Grade A (Schedule 10)
- ASTM A795, Type E, Grade A (Schedule 40)
- NFPA 13

Manufacturing Protocols

Schedule 10 and Schedule 40 are subjected to the toughest possible testing protocols to ensure the highest quality and long-lasting performance.

Finishes and Coatings

All Wheatland black steel fire sprinkler pipe up to 6" receives a proprietary mill coating to ensure a clean, corrosion-resistant surface that outperforms and outlasts standard lacquer coatings. This coating allows the pipe to be easily painted, without special preparation. Schedule 10 and Schedule 40 can be ordered in black, or with hot-dip galvanizing, to meet FM/UL requirements for dry systems that meet the zinc coating specifications of ASTM A795 or A53. All Wheatland galvanized material is also UL Listed.

Product Marking

Each length of Wheatland fire sprinkler pipe is continuously stenciled to show the manufacturer, type of pipe, grade, size and length. Barcoding is acceptable as a supplementary identification method.

SCHEDULE 10 SPECIFICATIONS

NPS	NOM OD		NOM ID		NOMINAL WALL		NOMINAL WEIGHT		UL CRR*	PIECES Lift
	in.	mm	in.	mm	in.	mm	lbs./ft.	kg/m		
1¼	1.660	42.2	1.442	36.6	.109	2.77	1.81	2.69	7.3	61
1½	1.900	48.3	1.682	42.7	.109	2.77	2.09	3.11	5.8	61
2	2.375	60.3	2.157	54.8	.109	2.77	2.64	3.93	4.7	37
2½	2.875	73.0	2.635	66.9	.120	3.05	3.53	5.26	3.5	30
3	3.500	88.9	3.260	82.8	.120	3.05	4.34	6.46	2.6	19
4	4.500	114.3	4.260	108.2	.120	3.05	5.62	8.37	1.6	19
5	5.563	141.3	5.295	134.5	.134	3.40	7.78	11.58	1.5	13
6	6.625	168.3	6.357	161.5	.134	3.40	9.30	13.85	1.0	10
8	8.625	219.1	8.249	209.5	.188	4.78	16.96	25.26	2.1	7

* Calculated using Standard UL CRR formula, UL Fire Protection Directory, Category VIZY.

* The CRR is a ratio value used to measure the ability of a pipe to withstand corrosion. Threaded Schedule 40 steel pipe is used as the benchmark (value of 1.0).

SCHEDULE 40 SPECIFICATIONS

NPS	NOM OD		NOM ID		NOMINAL WALL		NOMINAL WEIGHT		UL CRR*	PIECES Lift
	in.	mm	in.	mm	in.	mm	lbs./ft.	kg/m		
1	1.315	33.4	1.049	26.6	.133	3.38	1.68	2.50	1.00	70
1¼	1.660	42.2	1.380	35.1	.140	3.56	2.27	3.39	1.00	51
1½	1.900	48.3	1.610	40.9	.145	3.68	2.72	4.05	1.00	44
2	2.375	60.3	2.067	52.5	.154	3.91	3.66	5.45	1.00	30

* Calculated using Standard UL CRR formula, UL Fire Protection Directory, Category VIZY.

* The CRR is a ratio value used to measure the ability of a pipe to withstand corrosion. Threaded Schedule 40 steel pipe is used as the benchmark (value of 1.0).



SUBMITTAL INFORMATION

PROJECT:

CONTRACTOR:

DATE:

ENGINEER:

SPECIFICATION REFERENCE:

SYSTEM TYPE:

LOCATIONS:

COMMENTS:

BLACK

HOT-DIP GALVANIZED

Threaded Mechanical Branch Tee Fig. MT-1 & MT-1A



For Listings/Approval Details and Limitations, visit our website at www.asc-es.com or contact an ASC Engineered Solutions™ Sales Representative.

Mechanical branch connections are used in fire protection systems for reducing branch outlets without welding. The MT-1 & MT-1A are a bolted saddle type fittings with NPT female threaded outlets. Design assures superior sealing, full pipe support, excellent stability and easy installation.

For the latest UL/ULC listed, LPCB, VdS and FM Approved pressure ratings versus pipe schedule, visit our website at www.asc-es.com or contact an ASC Engineered Solutions™ Sales Representative.

Material Specifications

Housing

Ductile Iron conforming to ASTM A-536, Grade 65-45-12

Bolts

SAE J429, Grade 5, Zinc Electroplated
ISO 898-1, Class 8.8, Zinc Electroplated followed by a Yellow Chromate Dip

Heavy Hex Nuts

ASTM A563, Grade A, Zinc Electroplated
ISO 898-2, Class 8.8, Zinc Electroplated followed by a Yellow Chromate Dip

Coatings

Rust inhibiting paint Color: ORANGE (standard)
Hot Dipped Zinc Galvanized (optional)

Lubrication

Standard Gruvlok

Gruvlok Xtreme required for dry pipe systems and freezer applications

Gasket Materials

Properties as designated in accordance with ASTM D-2000.

Grade "E" EPDM (Green color code)

-40° F to 230° F (Service Temperature Range)
(-40° C to 110° C)

Recommended for water service, diluted acids, alkalies solutions, oil-free air and many chemical services.

NOT FOR USE IN PETROLEUM APPLICATIONS.



PROJECT INFORMATION	APPROVAL STAMP
Project:	Approved
Address:	Approved as noted
Contractor:	Not approved
Engineer:	Remarks:
Submittal Date:	
Notes 1:	
Notes 2:	

Threaded Mechanical Branch Tee Fig. MT-1 & MT-1A

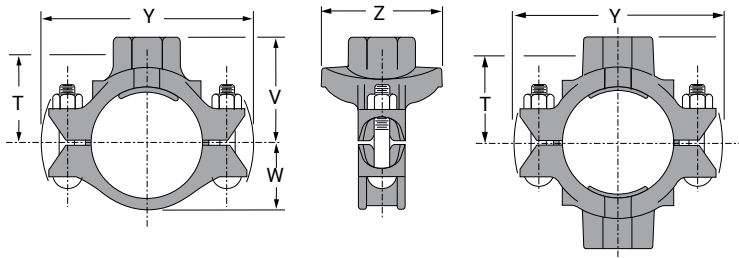

Fig. No.	Nominal Size	O.D.	Hole Dimensions		Max. Working Pressures▲	Dimensions					Bolt Size	Approx. Wt. Ea.	UL	FM
			Min. Diameter	Max. Diameter		U	V Threaded	W	Y	Z				
	In./DN(mm)	In./mm	In./mm	In./mm	PSI/bar	In./mm	In./mm	In./mm	In./mm	In./mm	In./mm	Lbs./Kg		
MT-1A	1¼ x ½ 32 x 15	1.660 x 0.840 42.4 x 21.3	1⅜ 30	1¼ 32	300 20.7	--	1¼ 32	1⅝ 29	3¾ 95.5	2¼ 57	⅜ x 1⅜	1.2 0.5	*	*
MT-1A	1¼ x ¾ 32 x 20	1.660 x 1.050 42.4 x 26.7	1⅜ 30	1¼ 32	300 20.7	--	1¾ 44	1⅝ 29	3¾ 95.5	2¼ 57	⅜ x 1⅜	1.2 0.5	*	*
MT-1A	1½ x ½ 40 x 15	1.900 x 0.840 48.3 x 21.3	1⅜ 30	1¼ 32	300 20.7	--	1⅝ 35.5	1¼ 32.5	4 101.5	2¼ 57	⅜ x 1⅜	1.3 0.6	*	*
MT-1A	1½ x ¾ 40 x 20	1.900 x 1.050 48.3 x 26.7	1⅜ 30	1¼ 32	300 20	--	1⅝ 47.5	1¼ 32.5	4 101.5	2¼ 57	⅜ x 1⅜	1.3 0.6	*	*
MT-1A	2 x ½ 50 x 15	2.375 x 0.840 60.3 x 21.3	1½ 38	1⅝ 41	300 20.7	2⅝ 53.8	2⅝ 67	1⅜ 40	4⅞ 124	2⅝ 53.8	⅜ x 2¼	1.7 0.8	*	*
MT-1A	2 x ¾ 50 x 20	2.375 x 1.050 60.3 x 26.7	1½ 38	1⅝ 41	300 20	2⅝ 53.8	2⅝ 67	1⅜ 40	4⅞ 124	2⅝ 53.8	⅜ x 2¼	1.7 0.8	*	*
MT-1	2 x 1 50 x 25	2.375 x 1.315 60.3 x 33.7	1½ 38	1⅝ 41	300 20.7	1⅝ 50	2⅝ 67	1⅜ 40	4⅞ 117	2½ 63	⅜ x 2	1.7 0.8	*	*
MT-1	2 x 1¼ 50 x 32	2.375 x 1.660 60.3 x 42.4	1¾ 44	1⅝ 48	300 20.7	1⅝ 49	2⅝ 67	1⅜ 40	4⅞ 117	2½ 63	⅜ x 2	1.7 0.8	*	*
MT-1	2 x 1½ 50 x 40	2.375 x 1.900 60.3 x 48.3	1¾ 44	1⅝ 48	300 20.7	1⅝ 49	2⅝ 67	1⅜ 40	4⅞ 117	2⅞ 73	⅜ x 2	1.7 0.8	*	*
MT-1A	2½ x ½ 65 x 15	2.875 x 0.840 73.0 x 21.3	1½ 38	1⅝ 41	300 20.7	2⅝ 60.5	2⅝ 73.2	1⅜ 46	5¼ 133.4	3⅜ 78	⅜ x 2¼	3.6 1.6	*	*
MT-1A	2½ x ¾ 65 x 20	2.875 x 1.050 73.0 x 26.7	1½ 38	1⅝ 41	300 20.7	2⅝ 60.5	2⅝ 73.2	1⅜ 46	5¼ 133.4	3⅜ 78	⅜ x 2¼	3.6 1.6	*	*
MT-1	2½ x 1 65 x 25	2.875 x 1.315 73.0 x 33.7	1½ 38	1⅝ 41	300 20.7	2⅝ 62	3⅝ 79	1⅜ 46	5⅞ 141	3⅝ 86	½ x 2¾	3.6 1.6	*	*
MT-1	2½ x 1¼ 65 x 32	2.875 x 1.660 73.0 x 42.4	2 51	2⅝ 54	300 20.7	2⅝ 62	3⅝ 79	1⅜ 46	5⅞ 141	3⅝ 86	½ x 2¾	3.6 1.6	*	*
MT-1	2½ x 1½ 65 x 40	2.875 x 1.900 73.0 x 48.3	2 51	2⅝ 54	300 20.7	2⅝ 62	3⅝ 79	1⅜ 46	5⅞ 141	3⅝ 86	½ x 2¾	3.6 1.6	*	*
MT-1A	3 x ½ 80 x 15	3.500 x 0.840 88.9 x 21.3	1½ 38	1⅝ 41	300 20.7	2⅝ 65	3⅝ 81	2⅝ 56.1	6⅝ 155.7	3⅜ 78	½ x 3	3.8 1.7	*	*
MT-1A	3 x ¾ 80 x 20	3.500 x 1.050 88.9 x 26.7	1½ 38	1⅝ 41	300 20.7	2⅝ 65	3⅝ 81	2⅝ 56.1	6⅝ 155.7	3⅜ 78	½ x 3	3.8 1.7	*	*

Note:

All sizes may be used as mechanical crosses. Threads are NPT per ANSI/ASME B1.20.1

▲ – Working Pressure Ratings are for reference only and based on Sch. 10 and Sch. 40 pipe. For the latest UL/ULC, FM, VdS and LPCB pressure ratings versus pipe schedule, please visit asc-es.com or contact your local ASC Engineered Solutions™ Representative.

Warning: For dry pipe systems and freezer applications lubrication of the gasket is required, Gruvlok Xtreme™ Lubricant is required.



asc-es.com

Building connections that last™

Threaded Mechanical Branch Tee Fig. MT-1 & MT-1A

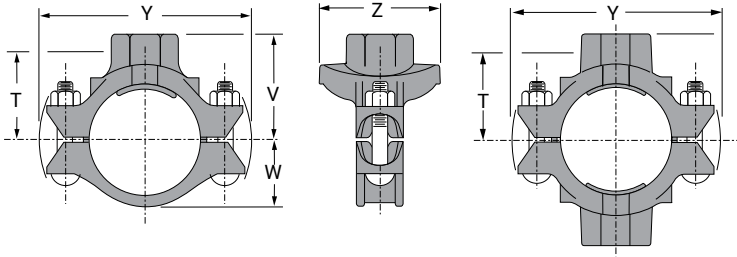

Fig. No.	Nominal Size	O.D.	Hole Dimensions		Max. Working Pressures▲	Dimensions					Bolt Size	Approx. Wt. Ea.	UL	FM
			Min. Diameter	Max. Diameter		U	V Threaded	W	Y	Z				
			In./DN(mm)	In./mm		In./mm	In./mm	PSI/bar	In./mm	In./mm				
MT-1	3 x 1 80 x 25	3.500 x 1.315 88.9 x 33.7	1½ 38	1⅝ 41	300 20.7	2¾ 71	3⅞ 87	2⅝ 55	6¼ 159	3⅝ 99	½ x 2¾	3.8 1.7	*	*
MT-1	3 x 1¼ 80 x 32	3.500 x 1.660 88.9 x 42.4	2 51	2⅝ 54	300 20.7	2¾ 70	3⅞ 87	2⅝ 55	6¼ 159	3⅝ 99	½ x 2¾	3.8 1.7	*	*
MT-1	3 x 1½ 80 x 40	3.500 x 1.900 88.9 x 48.3	2 51	2⅝ 54	300 20.7	2¾ 70	3⅞ 87	2⅝ 55	6¼ 159	3⅝ 99	½ x 2¾	3.8 1.7	*	*
MT-1	3 x 2 80 x 50	3.500 x 2.375 88.9 x 60.3	2½ 64	2⅝ 67	300 20.7	2¾ 70	3⅞ 87	2⅝ 55	6¼ 159	3⅝ 99	½ x 2¾	4.4 2.0	*	*
MT-1A	4 x ½ 100 x 15	4.500 x 0.840 114.3 x 21.3	1½ 38	1⅝ 41	300 20.7	3⅞ 78	3⅞ 93.7	2⅝ 70.6	7⅝ 181.1	3⅞ 78	½ x 3	4.6 2.1	*	*
MT-1A	4 x ¾ 100 x 20	4.500 x 1.050 114.3 x 26.7	1½ 38	1⅝ 41	300 20.7	3⅞ 78	3⅞ 93.7	2⅝ 70.6	7⅝ 181.1	3⅞ 78	½ x 3	4.6 2.1	*	*
MT-1	4 x 1 100 x 25	4.500 x 1.315 114.3 x 33.7	1½ 38	1⅝ 41	300 20.7	3⅞ 85	4 102	2⅝ 67	7¼ 184	3⅞ 97	½ x 2¾	4.6 2.1	*	*
MT-1	4 x 1¼ 100 x 32	4.500 x 1.660 114.3 x 42.4	2 51	2⅝ 54	300 20.7	3⅞ 84	4 102	2⅝ 67	7¼ 184	3⅞ 97	½ x 2¾	4.6 2.1	*	*
MT-1	4 x 1½ 100 x 40	4.500 x 1.900 114.3 x 48.3	2 51	2⅝ 54	300 20.7	3⅞ 84	4 102	2⅝ 67	7¼ 184	3⅞ 97	½ x 2¾	4.6 2.1	*	*
MT-1	4 x 2 100 x 50	4.500 x 2.375 114.3 x 60.3	2½ 64	2⅝ 67	300 20.7	3⅞ 84	4 102	2⅝ 67	7¼ 184	4½ 115	½ x 2¾	4.8 2.2	*	*
MT-1	4 x 2½ 100 x 65	4.500 x 2.875 114.3 x 73.0	2¾ 70	2⅝ 73	300 20.7	3⅞ 78	4 102	2⅝ 67	7¼ 184	4½ 115	½ x 2¾	5.4 2.4	*	*
MT-1	4 x 3 100 x 80	4.500 x 3.500 114.3 x 88.9	3½ 89	3⅝ 92	300 20.7	3 76	4⅞ 105	2⅝ 67	7¼ 184	5⅞ 130	½ x 2¾	5.4 2.4	*	*
MT-1	5 x 1½ 125 x 40	5.563 x 1.900 141.3 x 48.3	2 51	2⅝ 54	300 20.7	4⅞ 103	4¾ 121	3⅞ 81	8⅝ 211	3⅞ 97	⅝ x 4	7.4 3.4	*	*
MT-1	5 x 2 125 x 50	5.563 x 2.375 141.3 x 60.3	2½ 64	2⅝ 67	300 20.7	4⅞ 103	4¾ 121	3⅞ 81	8⅝ 211	3⅞ 97	⅝ x 4	7.9 3.6	*	*
MT-1	5 x 2½ 125 x 65	5.563 x 2.875 141.3 x 73.0	2¾ 70	2⅝ 73	300 20.7	3⅞ 97	4¾ 121	3⅞ 81	8⅝ 211	3⅞ 97	⅝ x 4	7.9 3.6	*	*

Note:

All sizes may be used as mechanical crosses. Threads are NPT per ANSI/ASME B1.20.1

▲ – Working Pressure Ratings are for reference only and based on Sch. 10 and Sch. 40 pipe. For the latest UL/ULC, FM, VdS and LPCB pressure ratings versus pipe schedule, please visit asc-es.com or contact your local ASC Engineered Solutions™ Representative.

Warning: For dry pipe systems and freezer applications lubrication of the gasket is required, Gruvlok Xtreme™ Lubricant is required.



asc-es.com

Building connections that last™

Threaded Mechanical Branch Tee Fig. MT-1 & MT-1A

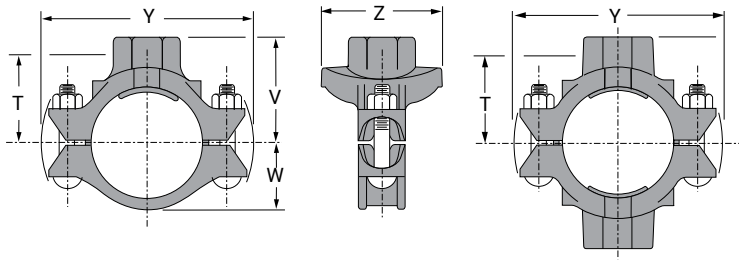

Fig. No.	Nominal Size	O.D.	Hole Dimensions		Max. Working Pressures▲	Dimensions					Bolt Size	Approx. Wt. Ea.	UL	FM
			Min. Diameter	Max. Diameter		U	V Threaded	W	Y	Z				
			In./DN(mm)	In./mm		In./mm	In./mm	PSI/bar	In./mm	In./mm				
MT-1	6 x 1¼ 150 x 32	6.625 x 1.660 168.3 x 42.2	2 51	2⅛ 54	300 20.7	3 ¹³ / ₁₆ 97	4 ¹⁵ / ₁₆ 126	3 ¹¹ / ₁₆ 94	9 ³ / ₈ 238	3 ⁷ / ₈ 98	5/8 x 4	8.0 3.6	*	*
MT-1	6 x 1½ 150 x 40	6.625 x 1.900 168.3 x 48.3	2 51	2⅛ 54	300 20.7	4 ⁷ / ₁₆ 113	5 ¹ / ₈ 130	3 ¹¹ / ₁₆ 94	9 ³ / ₈ 238	3 ⁷ / ₈ 98	5/8 x 4	7.5 3.4	*	*
MT-1	6 x 2 150 x 50	6.625 x 2.375 168.3 x 60.3	2½ 64	2 ⁵ / ₈ 67	300 20.7	4 ⁷ / ₁₆ 112	5 ¹ / ₈ 130	3 ¹¹ / ₁₆ 94	9 ³ / ₈ 238	4 ⁷ / ₁₆ 112	5/8 x 4	8.0 3.6	*	*
MT-1	6 x 2½ 150 x 65	6.625 x 2.875 168.3 x 73.0	2¾ 70	2 ⁷ / ₈ 73	300 20.7	4 ³ / ₁₆ 106	5 ¹ / ₈ 130	3 ¹¹ / ₁₆ 94	9 ³ / ₈ 238	4 ⁷ / ₁₆ 112	5/8 x 4	8.0 3.6	*	*
MT-1	6 x 3 150 x 80	6.625 x 3.500 168.3 x 88.9	3½ 89	3 ⁵ / ₈ 92	300 20.7	4 ¹ / ₈ 105	5 ¹ / ₄ 133	3 ¹¹ / ₁₆ 94	9 ³ / ₈ 238	5 ⁵ / ₈ 143	5/8 x 4	9.7 4.4	*	*
MT-1A	6 x 4 150 x 100	6.625 x 4.500 168.3 x 114.3	4½ 114.3	4 ⁵ / ₈ 117.5	300 20.7	4 ⁹ / ₁₆ 115.8	5 ³ / ₈ 136.7	3 ⁷ / ₈ 99.1	9 ¹ / ₄ 235	6 ¹ / ₈ 155.7	5/8 x 4¾	9.7 4.4	*	*
MT-1	8 x 2 200 x 50	8.625 x 2.375 219.1 x 60.3	2½ 64	2 ⁵ / ₈ 67	300 20.7	5 ⁷ / ₁₆ 138	6 ¹ / ₄ 159	4 ⁷ / ₈ 123	10 ⁵ / ₁₆ 313	4 ⁷ / ₁₆ 112	¾ x 4¼	10.2 4.6	*	*

Note:

All sizes may be used as mechanical crosses. Threads are NPT per ANSI/ASME B1.20.1

▲ – Working Pressure Ratings are for reference only and based on Sch. 10 and Sch. 40 pipe. For the latest UL/ULC, FM, VdS and LPCB pressure ratings versus pipe schedule, please visit asc-es.com or contact your local ASC Engineered Solutions™ Representative.

Warning: For dry pipe systems and freezer applications lubrication of the gasket is required, Gruvlok Xtreme™ Lubricant is required.



asc-es.com

Building connections that last™

Fig. MT-1, MT-1A & MT-8 Threaded Mechanical Branch

ALWAYS USE A GRUVLOK® SPF/ANVIL® LUBRICANT FOR PROPER COUPLING ASSEMBLY.

Thorough lubrication of the gasket is essential to assist the gasket into the proper sealing position.

1 Pipe preparation

Cut the appropriate size hole in the pipe and remove any burrs. Be sure to remove the slug from inside the pipe. Clean the gasket sealing surface within 5/8" (16mm) of the hole and visually inspect the sealing surface for defects that may prevent proper sealing of the gasket.

Branch Size	Hole Saw Size	Flow Data	
		MT-1/MT-1A	MT-8
Inches (mm)	Inches +1/8, -0 (mm +3, -0)	(see note)	
1 25	1½ 38	2 0.61	2 0.61
1¼(2"run) 32 (50mm run)	1¾ 44	4 1.22	4 1.22
1¼(2½-6" run) 32 (65-150mm run)	2 51	4 1.22	4 1.22
1½(2"run) 40 (50mm run)	1¾ 44	8 2.44	4 1.22
1½(2½-6" run) 40 (65-150mm run)	2 51	8 2.44	4 1.22
2 50	2½ 64	9 2.74	9 2.74
2½ 65	2¾ 70	10 3.05	10 3.05
3 O.D. 76.1	2¾ 70	7 2.13	7 2.13
3 80.4	3½ 89	8 2.44	8 2.44

Note: Flow Data is expressed as Feet/Meters of Schedule 40 steel outlet pipe with a "Hazen-Williams coefficient of friction value of 120".

2 Check and lubricate gasket

Check the gasket to be sure it is compatible for the intended service. Apply a thin layer of Gruvlok SPF/Anvil lubricant to the back surface of the gasket. Be careful that foreign particles do not adhere to the lubricated surfaces. Insert the gasket back into the outlet housing making sure the tabs in the gasket line up with the tab recesses in the housing.

3 Gasket installation

Lubricate the exposed surface of the gasket. Align the outlet housing over the pipe hole making sure that the locating collar is in the pipe hole.

4 Alignment

Align the strap around the pipe, insert the bolts and tighten the nuts finger tight.

5 Tighten nuts

Alternately and evenly tighten the nuts to the specified bolt torque.

6 Assembly is complete

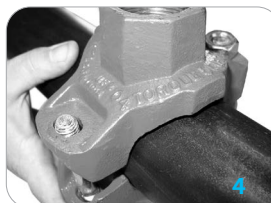

Specified Bolt Torque

Specified bolt torque is for the oval neck track bolts used on SPF threaded mechanical branches. The nuts must be tightened alternately and evenly until fully tightened.

Caution: Proper torquing of mechanical branch bolts is required to obtain specified performance. **Over torquing the bolts may result in damage to the bolt and/or casting which could result in pipe joint separation.** Under torquing the bolts may result in lower pressure retention capabilities, lower bend load capabilities, joint leakage and pipe joint separation. Pipe joint separation may result in significant property damage and serious injury.

ANSI Specified Bolt Torque

Bolt Size	Wrench Size	Specified Bolt Torque*
In.	In.	Ft.-Lbs
3/8	11/16	30-45
1/2	7/8	80-100
5/8	1 1/16	100-130
3/4	1 1/4	130-180

* Non-lubricated bolt torque

Metric Specified Bolt Torque

Bolt Size	Wrench Size	Specified Bolt Torque*
mm	mm	N-M
M10	16	40-60
M12	22	110-150
M16	24	135-175
M20	30	175-245

* Non-lubricated bolt torque



asc-es.com

Building connections that last™

Reducing 90° Elbow Fig. 3201R



For Listings/Approval Details and Limitations, visit our website at www.asc-es.com or contact an ASC Engineered Solutions™ Sales Representative.

Fig. 3201R Reducing 90° Elbow

Nominal Size	Max. Working Pressure ▲	Dimensions		Approx Wt. Each
		A	B	
1 x 2				
In. (mm)	PSI (kPa)	In. (mm)	In. (mm)	Lbs. (kg)
1 x ½	500	1.26	1.36	0.44
25 x 15	3450	32.00	34.54	0.20
1 x ¾	500	1.37	1.45	0.52
25 x 20	3450	34.79	36.83	0.24
1¼ x ½	500	1.34	1.53	0.64
32 x 15	34550	34.03	38.86	0.29
1¼ x ¾	500	1.45	1.62	0.72
32 x 20	3450	36.83	41.14	0.33
1¼ x 1	500	1.58	1.67	0.75
32 x 25	3450	40.13	42.41	0.34
1½ x ½	500	1.41	1.66	0.64
40 x 15	3450	35.81	42.16	0.29
1½ x ¾	500	1.52	1.75	0.77
40 x 20	3450	38.61	44.45	0.35
1½ x 1	500	1.65	1.80	0.92
40 x 25	3450	41.91	45.72	0.42
1½ x 1¼	500	1.82	1.88	1.08
40 x 32	3450	46.22	47.75	0.49
2 x ½	500	1.49	1.88	1.08
50 x 15	3450	37.84	47.75	0.49
2 x ¾	500	1.60	1.97	1.24
50 x 20	3450	40.64	50.03	0.56
2 x 1	500	1.73	2.02	1.40
50 x 25	3450	43.94	51.30	0.64
2 x 1¼	500	1.90	2.10	1.52
50 x 32	3450	48.26	53.34	0.70
2 x 1½	500	2.02	2.16	1.65
50 x 40	3450	51.30	54.86	0.75

Material Specifications

- **Dimensions:** ASME B16.3
- **Material:** ASTM A536 Grade 65-45-12
- **Finish:** Black
- **Threads:** NPT per ASME B1.20.1
- **Agency Approvals:** All ductile iron threaded fittings are UL/ULC Listed and FM Approved.

Note: Ductile iron fittings have higher tensile strength than that of steel pipe. Therefore, over tightening can cause damage to pipe threads which may cause leakage. Ductile iron fittings should be tightened approximately three turns beyond hand tight, but no more than four turns.

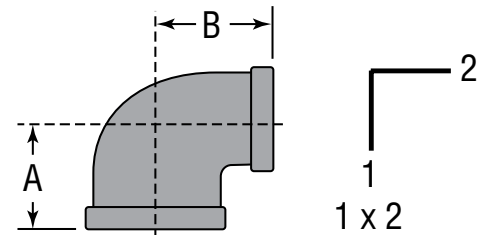

▲ – Working Pressure Ratings are for reference only and based on Sch. 40 pipe. For the latest UL/ULC, and FM pressure ratings versus pipe schedule, please visit www.asc-es.com or contact your local ASC Engineered Solutions™ Representative.

PROJECT INFORMATION	APPROVAL STAMP
Project:	Approved
Address:	Approved as noted
Contractor:	Not approved
Engineer:	Remarks:
Submittal Date:	
Notes 1:	
Notes 2:	

Fig. 3201 90° Elbow



Material Specifications

Dimensions: ASME B16.3

Material: ASTM A536 Grade 65-45-12

Finish: Black

Threads: NPT per ASME B1.20.1

Agency Approvals: All ductile iron threaded fittings are UL/ULC Listed and FM Approved.

Note: Ductile iron fittings have higher tensile strength than that of steel pipe. Therefore, over tightening can cause damage to pipe threads which may cause leakage. Ductile iron fittings should be tightened approximately three turns beyond hand tight, but no more than four turns.

Figure 3201 90° Elbow

Nominal Size	Maximum Working Pressure ▲	Dimension A	Approx Wt. Each
In. (mm)	psi (kPa)	In. (mm)	Lbs. (kg)
1 20	500 3450	1.50 38.10	0.62 0.68
1¼ 32	500 3450	1.75 44.45	0.90 0.41
1½ 40	500 3450	1.94 49.276	1.20 0.54
2 50	500 3450	2.25 57.15	1.85 0.84

▲ - Working Pressure Ratings are for reference only and based on Sch. 40 pipe. For the latest UL/ULC, and FM pressure ratings versus pipe schedule, please visit asc-es.com or contact your local ASC Engineering Solutions™ Representative.

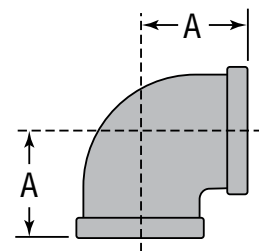

PROJECT INFORMATION	APPROVAL STAMP
Project:	Approved
Address:	Approved as noted
Contractor:	Not approved
Engineer:	Remarks:
Submittal Date:	
Notes 1:	
Notes 2:	

Straight Tee Fig. 3205

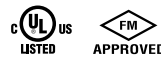

For Listings/Approval Details and Limitations, visit our website at www.asc-es.com or contact an ASC Engineered Solutions™ Sales Representative.

Material Specifications

Dimensions: ASME B16.3

Material: ASTM A536 Grade 65-45-12

Finish: Black

Threads: NPT per ASME B1.20.1

Agency Approvals: All ductile iron threaded fittings are UL/ULC Listed and FM Approved.

Note: Ductile iron fittings have higher tensile strength than that of steel pipe. Therefore, over tightening can cause damage to pipe threads which may cause leakage. Ductile iron fittings should be tightened approximately three turns beyond hand tight, but no more than four turns.

Figure 3205 Straight Tee

Nominal Size	Maximum Working Pressure ▲	Dimension A	Approx Wt. Each
In. (mm)	psi (kPa)	In. (mm)	Lbs. (kg)
1 25	500 3450	1.50 38.10	0.85 0.39
1¼ 32	500 3450	1.75 44.45	1.22 0.55
1½ 40	500 3450	1.94 49.27	1.55 0.70
2 50	500 3450	2.25 57.15	2.45 1.11

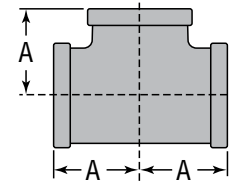

▲ - Working Pressure Ratings are for reference only and based on Sch. 40 pipe. For the latest UL/ULC, and FM pressure ratings versus pipe schedule, please visit asc-es.com or contact your local ASC Engineering Solutions™ Representative.



PROJECT INFORMATION	APPROVAL STAMP
Project:	Approved
Address:	Approved as noted
Contractor:	Not approved
Engineer:	Remarks:
Submittal Date:	
Notes 1:	
Notes 2:	

Reducing Coupling Fig. 3221R



Material Specifications

Dimensions: ASME B16.3

Material: ASTM A536 Grade 65-45-12

Finish: Black

Threads: NPT per ASME B1.20.1

Agency Approvals: All ductile iron threaded fittings are UL/ULC Listed and FM Approved.

Note: Ductile iron fittings have higher tensile strength than that of steel pipe. Therefore, over tightening can cause damage to pipe threads which may cause leakage. Ductile iron fittings should be tightened approximately three turns beyond hand tight, but no more than four turns.

Figure 3221R Reducing Coupling

Nominal Size	Maximum Working Pressure ▲	Dimension A	Approx Wt. Each
In. (mm)	psi (kPa)	In. (mm)	Lbs. (kg)
1x½ 25 x 15	500 3450	1.69 42.92	0.39 0.18
1 x ¾ 25 x 20	500 3450	1.69 42.92	0.53 0.24
1¼ x ¾ 32 x 20	500 3450	2.06 52.32	0.64 0.29

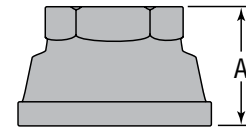

▲ - Working Pressure Ratings are for reference only and based on Sch. 40 pipe. For the latest UL/ULC, and FM pressure ratings versus pipe schedule, please visit asc-es.com or contact your local ASC Engineering Solutions™ Representative.



PROJECT INFORMATION	APPROVAL STAMP
Project:	Approved
Address:	Approved as noted
Contractor:	Not approved
Engineer:	Remarks:
Submittal Date:	
Notes 1:	
Notes 2:	

Cap
Fig. 3224



Material Specifications

Dimensions: ASME B16.3

Material: ASTM A536 Grade 65-45-12

Finish: Black

Threads: NPT per ASME B1.20.1

Agency Approvals: All ductile iron threaded fittings are UL/ULC Listed and FM Approved.

Note: Ductile iron fittings have higher tensile strength than that of steel pipe. Therefore, over tightening can cause damage to pipe threads which may cause leakage. Ductile iron fittings should be tightened approximately three turns beyond hand tight, but no more than four turns.

Figure 3224 Cap

Nominal Size	Maximum Working Pressure ▲	Dimension A	Approx Wt. Each
In. (mm)	psi (kPa)	In. (mm)	Lbs. (kg)
1	500	1.16	0.32
25	3450	29.46	0.15
1¼	500	1.28	0.43
32	3450	32.51	0.20
1½	500	1.33	0.60
40	3450	33.78	0.27
2	500	1.45	0.91
50	3450	36.83	0.41

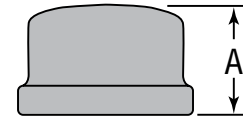

▲ – Working Pressure Ratings are for reference only and based on Sch. 40 pipe. For the latest UL/ULC, and FM pressure ratings versus pipe schedule, please visit asc-es.com or contact your local ASC Engineered Solutions™ Representative.

PROJECT INFORMATION	APPROVAL STAMP
Project:	Approved
Address:	Approved as noted
Contractor:	Not approved
Engineer:	Remarks:
Submittal Date:	
Notes 1:	
Notes 2:	

Bushings Fig. 3283



Material Specifications

Dimensions: ASME B16.14

Material: ASTM A536 Grade 65-45-12

Finish: Black

Threads: NPT per ASME B1.20.1

Agency Approvals: All ductile iron threaded fittings are UL/ULC Listed and FM Approved.

Note: Ductile iron fittings have higher tensile strength than that of steel pipe. Therefore, over tightening can cause damage to pipe threads which may cause leakage. Ductile iron fittings should be tightened approximately three turns beyond hand tight, but no more than four turns.

Figure 3283 Bushings

Nominal Size Male (M) x Female (F)	Maximum Working Pressure ▲	Dimensions			Style	Approx Wt. Each
		A	B	C		
In. (mm)	psi (kPa)	In. (mm)	In. (mm)	In. (mm)	-	Lbs. (kg)
1 x 1/2 25 x 15	500 3450	0.75 19.05	0.25 6.35	1.42 36.06	Outside	0.22 0.10
1 x 3/4 25 x 20	500 3450	0.75 19.05	0.25 6.35	1.42 36.06	Outside	0.17 0.08
1 1/4 x 1 32 x 25	500 3450	0.80 20.32	0.28 7.11	1.76 44.70	Outside	0.28 0.13
1 1/2 x 1 40 x 25	500 3450	0.83 21.08	0.31 7.874	2.00 50.80	Outside	0.45 0.20
1 1/2 x 1 1/4 40 x 32	500 3450	0.83 21.08	0.31 7.874	2.00 50.80	Outside	0.30 0.14
2 x 1 50 x 25	500 3450	0.88 22.35	0.41 10.414	1.95 49.43	Inside	0.67 0.30
2 x 1 1/4 50 x 32	500 3450	0.88 22.35	0.34 8.636	2.48 62.99	Outside	0.73 0.33
2 x 1 1/2 50 x 40	500 3450	0.88 22.35	0.34 8.636	2.48 62.99	Outside	0.61 0.28

▲ - Working Pressure Ratings are for reference only and based on Sch. 40 pipe. For the latest UL/ULC, and FM pressure ratings versus pipe schedule, please visit asc-es.com or contact your local ASC Engineering Solutions™ Representative.

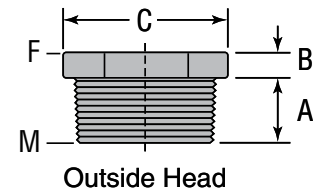
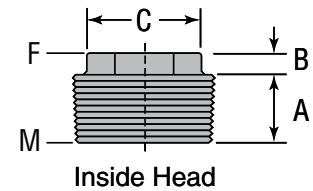

PROJECT INFORMATION	APPROVAL STAMP
Project:	Approved
Address:	Approved as noted
Contractor:	Not approved
Engineer:	Remarks:
Submittal Date:	
Notes 1:	
Notes 2:	

Cored Plug Fig. 3388

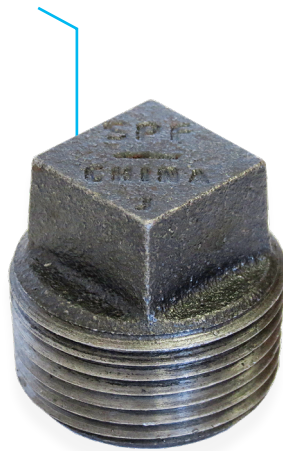

Material Specifications

Dimensions: ASME B16.14

Material: ASTM A536 Grade 65-45-12

Finish: Black

Threads: NPT per ASME B1.20.1

Agency Approvals: All ductile iron threaded fittings are UL/ULC Listed and FM Approved.

▲ Pressure – Temperature Ratings in accordance with ASME B16.3 Class 150

Note: Ductile iron fittings have higher tensile strength than that of steel pipe. Therefore, over tightening can cause damage to pipe threads which may cause leakage. Ductile iron fittings should be tightened approximately three turns beyond hand tight, but no more than four turns.

Figure 3388 Cored Plug

Nominal Size	Maximum Working Pressure ▲	Dimension A	Approx. Wt. Each
In. (mm)	psi (kPa)	In. (mm)	Lbs. (kg)
1/2*	500	0.94	0.10
15	3450	23.87	0.05
3/4	500	1.07	0.17
20	3450	27.17	0.08
1	500	1.25	0.28
25	3450	31.75	0.13
1 1/4	500	1.36	0.44
32	3450	34.54	0.20
1 1/2	500	1.45	0.62
40	3450	36.83	0.28
2	500	1.56	0.91
50	3450	39.62	0.41

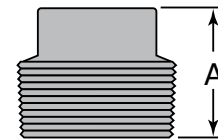

▲ – Working Pressure Ratings are for reference only and based on Sch. 40 pipe. For the latest UL/ULC, and FM pressure ratings versus pipe schedule, please visit asc-es.com or contact your local ASC Engineering Solutions™ Representative.

*Part supplied as Solid Plug.



PROJECT INFORMATION	APPROVAL STAMP
Project:	Approved
Address:	Approved as noted
Contractor:	Not approved
Engineer:	Remarks:
Submittal Date:	
Notes 1:	
Notes 2:	

Cap
Fig. SK-1



Material Specifications

Cast Fittings

Ductile Iron conforming to ASTM A536

Coatings

Rust inhibiting paint

Color: Orange (standard)

Hot Dipped Zinc Galvanized conforming to ASTM A153 (optional)

Other available options

Example: RAL3000 or RAL9000 Series

For Listings/Approval Details and Limitations, visit our website at www.asc-es.com or contact an ASC Engineered Solutions™ Sales Representative.



PROJECT INFORMATION	APPROVAL STAMP
Project:	Approved
Address:	Approved as noted
Contractor:	Not approved
Engineer:	Remarks:
Submittal Date:	
Notes 1:	
Notes 2:	

Cap Fig. SK-1

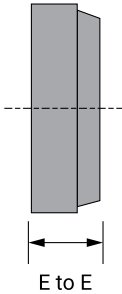

Nominal Size	O.D.	End to End	Approx. Wt. Ea.
In./DN(mm)	In./mm	In./mm	Lbs./kg
1¼ 32	1.660 42.2	1 25	0.4 0.2
1½ 40	1.900 48.3	1 25	0.5 0.2
2 50	2.375 60.3	1 25	0.7 0.3
2½ 65	2.875 73.0	1 25	1.0 0.4
3 80	3.500 88.9	1 25	1.5 0.7
4 100	4.500 114.3	1½/₁₆ 27	2.7 1.2
5 125	5.563 141.3	1½/₁₆ 27	4.4 2.0
6 150	6.625 168.3	1½/₁₆ 27	6.6 3.0
8 200	8.625 219.1	1¾/₁₆ 30	11.3 5.1
10* 250	10.750 273.1	1¼ 32	21.0 9.5
12* 300	12.750 323.9	1¼ 32	35.5 16.1

Note:

*Supplied as Style K-1 only.



asc-es.com

Building connections that last™

**Rigid Coupling
Fig. C-4**

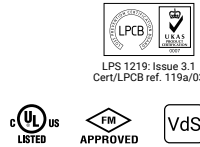

Material Specifications

Housing

Ductile Iron conforming to ASTM A536, Grade 65-45-12

Bolts

SAE J429, Grade 5, Zinc Electroplated (Standard)

Heavy Hex Nuts

ASTM A563, Grade A, Zinc Electroplated, Violet Dyed (Standard)

Coatings

- Rust inhibiting paint
- Color: Orange (Standard)
- Hot Dipped Zinc Galvanized (Optional)

Lubrication

- Standard Gruvlok
- Gruvlok Xtreme

Gasket Materials

Properties as designated in accordance with ASTM D2000

Pre-Lubricated Grade "E" EPDM, Type A C-Style Gasket (Violet color code)

-40°F to 150°F (Service Temperature Range)
(-40°C to 66°C)

Recommended for wet and dry (oil free air) fire protection sprinkler systems. For freezing conditions, Gruvlok Xtreme Lubricant is required.

Grade "EP" EPDM Flush Gap Gasket (Green color code)

-40°F to 230°F (Service Temperature Range)
(-40°C to 110°C)

Recommended for wet and dry (oil free air) fire protection sprinkler systems. For freezing conditions, Gruvlok Xtreme Lubricant is required.

The C-4 Rigid Coupling is our standard coupling and is designed for rigid piping applications. The C-4 is specially designed to provide a rigid, locked-in pipe connection to meet the specific demands of rigid design steel pipe.

For Listings/Approval Details and Limitations, visit our website at www.asc-es.com or contact an ASC Engineered Solutions™ Sales Representative.



PROJECT INFORMATION	APPROVAL STAMP
Project:	Approved
Address:	Approved as noted
Contractor:	Not approved
Engineer:	Remarks:
Submittal Date:	
Notes 1:	
Notes 2:	

Rigid Coupling Fig. C-4

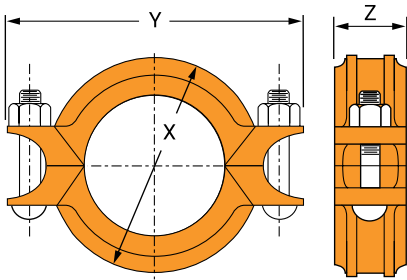

Nominal Size	Pipe O.D.	Max. Working Pressure ▲	Max. End Load	Range of Pipe End Separation	Coupling Dimensions			Coupling Bolts		Approx. Wt. Ea.
					X	Y	Z	Qty.	Size	
In./DN(mm)	In./mm	PSI/bar	Lbs./kN	In./mm	In./mm	In./mm	In./mm		In./mm	Lbs./kg
1 25	1.315 33.4	300 20.7	407 1.81	0-1/32 0-0.79	2 3/8 60	4 102	1 3/4 44	2	3/8 x 2 1/4 M10 x 57	1.2 0.5
1 1/4 32	1.660 42.2	300 20.7	649 2.89	0-1/32 0-0.79	2 5/8 67	4 1/4 108	1 23/32 44	2	3/8 x 2 1/4 M10 x 57	1.4 0.6
1 1/2 40	1.900 48.3	300 20.7	851 3.78	0-1/32 0-0.79	2 7/8 73	4 1/2 114	1 23/32 44	2	3/8 x 2 1/4 M10 x 57	1.5 0.7
2 50	2.375 60.3	300 20.7	1,329 5.91	0-1/32 0-0.79	3 11/32 85	5 3/16 132	1 23/32 44	2	3/8 x 2 1/4 M10 x 57	1.7 0.8
2 1/2 65	2.875 73.0	300 20.7	1,948 8.66	0-1/32 0-0.79	3 7/8 98	5 11/16 144	1 23/32 44	2	3/8 x 2 1/2 M10 x 63	1.9 0.9
3 O.D. 76.1	2.996 76.1	300 20.7	2,115 9.41	0-1/32 0-0.79	4 1/8 105	6 1/8 156	1 7/8 48	2	3/8 x 2 1/2 M10 x 63	2.2 1.0
3 80	3.500 88.9	300 20.7	2,886 12.84	0-1/32 0-0.79	4 1/2 114	6 1/4 159	1 3/4 44	2	3/8 x 3 M10 x 70	2.4 1.1
4 100	4.500 114.3	300 20.7	4,771 21.22	0-3/32 0-2.38	5 3/4 146	7 7/16 189	1 7/8 48	2	3/8 x 3 M10 x 70	3.5 1.6
5 1/2 O.D. 139.7	5.500 139.7	300 20.7	7,127 31.70	0-3/32 0-2.38	6 7/8 175	9 1/4 235	2 1/16 52	2	1/2 x 3 M12 x 76	5 2.2
5 125	5.563 141.3	300 20.7	7,292 32.44	0-3/32 0-2.38	6 13/16 173	8 15/16 227	1 7/8 48	2	1/2 x 3 M12 x 70	4.5 2.0

Note:

Range of Pipe End Separation values are for roll grooved pipe and may be doubled for cut groove pipe.

1. Working pressure and/or end load are total allowable, based on standard weight steel pipe, roll or cut grooved.
2. One time field test pressure may be increased to 1.5 times the figures listed above.

▲ – Working Pressure Ratings are for reference only and based on Sch. 10 and Sch. 40 pipe.

WARNING: For dry pipe systems and freezer applications lubrication of the gasket is required, Gruvlok Xtreme Lubricant is required.



asc-es.com

Building connections that last™

Rigid Coupling Fig. C-4

(continued)

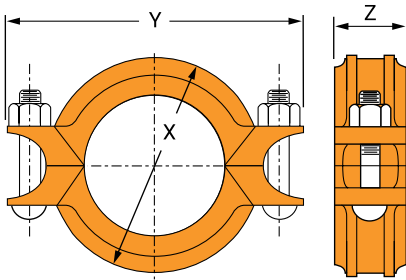

Nominal Size	Pipe O.D.	Max. Working Pressure ▲	Max. End Load	Range of Pipe End Separation	Coupling Dimensions			Coupling Bolts		Approx. Wt. Ea.
					X	Y	Z	Qty.	Size	
In./DN(mm)	In./mm	PSI/bar	Lbs./kN	In./mm	In./mm	In./mm	In./mm	In./mm	Lbs./kg	
6½ O.D. 165.1	6.500 165.1	300 20.7	9,955 44.28	0-¾/₃₂ 0-2.38	8⅞ 207	10¾/₈ 264	2⅛ 54	2 M12 x 76	5.8 2.6	
6 150	6.625 168.3	300 20.7	10,341 46.00	0-¾/₃₂ 0-2.38	7⅞ 200	10⅞/₁₆ 256	1⅞/₁₆ 49	2 M12 x 70	5.4 2.4	
8 200	8.625 219.1	300 20.7	17,528 77.97	0-¾/₃₂ 0-2.38	10⅞ 257	12⅞/₁₆ 316	2⅞/₈ 60	2 M12 x 70	9.5 4.3	
10 250	10.750 273.1	300 20.7	27,229 121.12	0-¾/₃₂ 0-2.38	13 331	16¾/₄ 425	2⅞/₈ 67	2 M22 x 125	21.5 9.8	
12 300	12.750 323.9	300 20.7	38,303 170.38	0-¾/₃₂ 0-2.38	15¾/₈ 391	19¼/₄ 489	2⅞/₈ 67	2 M22 x 140	27.4 12.4	

Note:

Range of Pipe End Separation values are for roll grooved pipe and may be doubled for cut groove pipe.

- Working pressure and/or end load are total allowable, based on standard weight steel pipe, roll or cut grooved.
- One time field test pressure may be increased to 1.5 times the figures listed above.

▲ – Working Pressure Ratings are for reference only and based on Sch. 10 and Sch. 40 pipe.

WARNING: For dry pipe systems and freezer applications lubrication of the gasket is required, Gruvlok Xtreme Lubricant is required.



asc-es.com

Building connections that last™

Fig. C-4 Rigid Coupling



Read and understand all instructions before use.

WARNING

Ensure system is drained and depressurized before installation or service.

Use appropriate personal protective equipment.



Failure to follow these instructions could result in serious personal injury and/or property damage.

Check pipe ends for proper grooved dimensions and to ensure that the pipe is free of indentations, projections, or other imperfections that would prevent proper sealing of the gasket.

1 Check and lubricate gasket

Check gasket to be sure it is compatible for the intended service. Apply a thin coating of Gruvlok lubricant to the exterior surface and sealing lips of the gasket. Some applications require lubrication of the entire gasket surface. Be careful that foreign particles do not adhere to lubricated surfaces. Pre-lubricated gaskets do not require lubrication.

Notice: Gruvlok Xtreme Lubricant must be applied when used in dry pipe systems or freezer applications.



2 Gasket installation

Slip the gasket over the pipe end making sure the gasket lip does not overhang the pipe end.

On couplings 10" and larger it may be easier to turn the gasket inside out then lubricate and slide the gasket over the pipe end as shown.

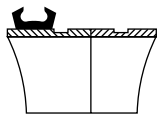

3 Alignment

After aligning the two pipe ends, pull the gasket into position centering it between the grooves on each pipe. Gasket should not extend into the groove on either pipe.

On couplings 10" and larger, flip or roll the gasket into centered position.

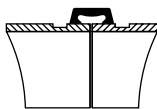

4 Housings

Remove one nut and bolt and loosen the other nut. Place one housing over the gasket, making sure the housing keys fit into the pipe grooves. Swing the other housing over the gasket and into the grooves on both pipes, making sure the tongue and recess of each housing is properly mated. Reinsert the bolt and run-up both nuts finger tight.

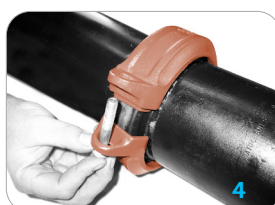

5 Tighten nuts

Securely tighten nuts alternately and equally, keeping the gaps at the bolt pads evenly spaced.

Notice: Uneven tightening may cause the gasket to pinch. Gasket should not be visible between segments after bolts are tightened.



6 Assembly is complete

Visually inspect the pipe joint to assure the coupling keys are fully engaged in the pipe grooves. The bolt pads are to have equal gaps on each side of the coupling.

Notice: Visually inspect both sides of the coupling to ensure gaps between bolt pads are evenly spaced and are parallel. Any deviations must be corrected before placing coupling into service.



ANSI Specified Bolt Torque

Bolt Size	Wrench Size	Specified Bolt Torque*
In.	In.	Ft.-Lbs
3/8	11/16	30-45
1/2	7/8	80-100
5/8	1 1/16	100-130
7/8	1 7/16	180-220

* Non-lubricated bolt torque.



asc-es.com

Building connections that last™

90° Short Pattern Elbow Fig. SE-1



Material Specifications

Cast Fittings

Ductile Iron conforming to ASTM A536, Grade 65-45-12

Coatings

Rust inhibiting paint

Color: Orange (standard)

Hot Dipped Zinc Galvanized conforming to ASTM A153 (optional)

Other available options

Example: RAL3000 or RAL9000 Series



LPS 1219: Issue 3.1
Cert/LPCB ref. 519a/20

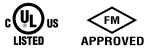

SE-1 are short pattern products and are specifically designed for use in Fire Protection applications where economy is a factor. All products are UL/ULC Listed, LPCB, VdS and FM Approved.

Maximum working pressure for these products is 300 PSI. For the latest UL/ULC listed, LPCB, VdS and FM Approved pressure ratings versus pipe schedule, see www.asc-es.com or contact your local ASC Engineered Solutions™ Representative.

For Listings/Approval Details and Limitations, visit our website at www.asc-es.com or contact an ASC Engineered Solutions™ Sales Representative.



PROJECT INFORMATION	APPROVAL STAMP
Project:	Approved
Address:	Approved as noted
Contractor:	Not approved
Engineer:	Remarks:
Submittal Date:	
Notes 1:	
Notes 2:	

90° Short Pattern Elbow Fig. SE-1

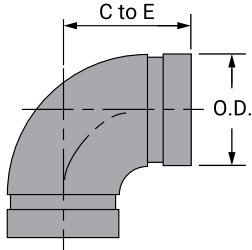

Nominal Size	O.D.	Center to End	Approx. Wt. Ea.
In./DN(mm)	In./mm	In./mm	Lbs./kg
2	2.375	2¾	1.5
50	60.3	70	0.7
2½	2.875	3	2.1
65	73.0	76	1.0
3	3.500	3¾	3.6
80	88.9	86	1.6
4	4.500	4	5.8
100	114.3	102	2.6
6	6.625	5½	11.8
150	168.3	140	5.3
8	8.625	6¾	21.1
200	219.1	175	9.6

Note:

Additional sizes available, contact an ASC Engineered Solutions™ Representative.

SE-1 90° Elbow Short Pattern Fitting - Pressure Drop

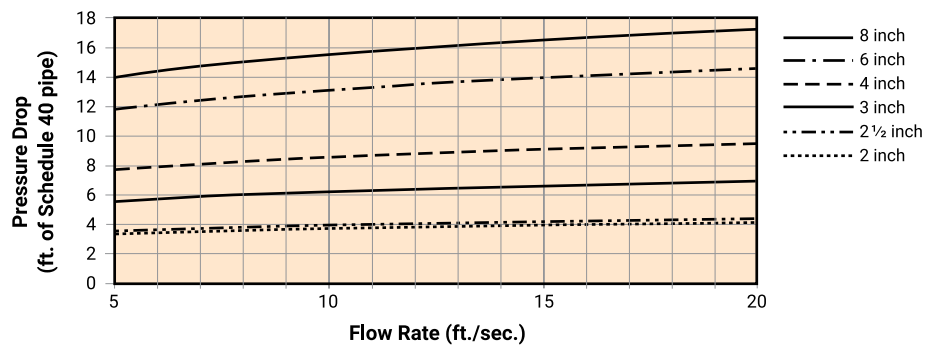

Note:

SPF/Anvil® short pattern fittings exceed the headloss requirements of NFPA 13.

For Fig. SE-1 90° grooved end elbows use the value shown.

Above values are shown for Schedule 40 pipe to be consistent with industry practices.



asc-es.com

Building connections that last™

Continuous Threaded Rod

Fig. 146 (Formerly Afcon Fig. 650)

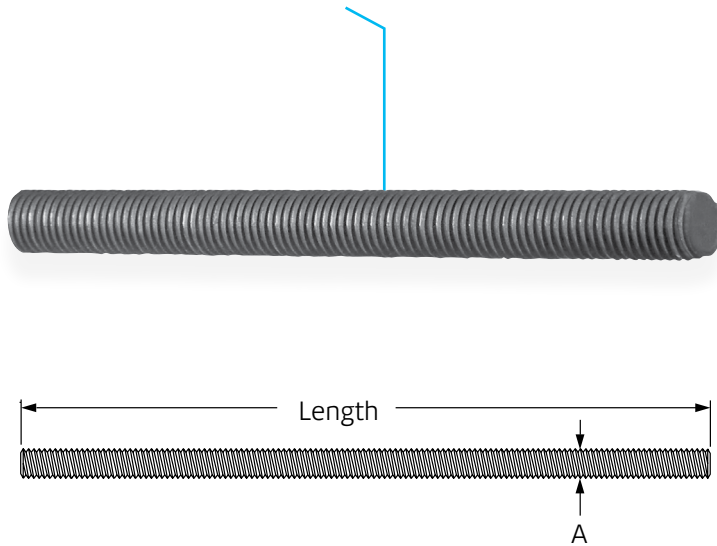

Size Range: ¼" through 1½" stocked in six, ten, and twelve foot lengths. Other even foot lengths can be furnished to order.

Material: Carbon steel or Stainless Steel Gr 304

Threads: National Coarse (USS), rod threaded complete length.

Finish: Plain or Zinc Plated (Hot-Dip Galvanized optional)

Maximum Temperature: Zinc Plated 450°F, Stainless Steel 650°F

Approvals: Complies with MSS SP-58.

Ordering: Specify rod diameter and length, figure number, name and finish.

Note: The acceptability of galvanized coatings at temperatures above 450°F is at the discretion of the end user.



Fig. 146: Dimensions (in) • Loads (lbs) • Weight (lbs)

Rod Size A	Threads per Inch	Max Load	Weight per Ft.
		650° F	
¼	20	240	0.12
⅜	16	730	0.30
½	13	1,350	0.53
⅝	11	2,160	0.84
¾	10	3,230	1.20
⅞	9	4,480	1.70
1	8	5,900	2.30
1¼	7	9,500	3.60
1½	6	13,800	5.10

PROJECT INFORMATION	APPROVAL STAMP
Project:	Approved
Address:	Approved as noted
Contractor:	Not approved
Engineer:	Remarks:
Submittal Date:	
Notes 1:	
Notes 2:	

Universal C-type Clamp (Standard Throat)

Fig. 92 (Formerly Afcon Fig. 100)

Material Specifications

Size Range
3/8" and 1/2"

Material
Ductile iron, hardened steel cup point set screw and locknut.

Finish
Plain
Zinc Plated (Hot-Dip Galvanized optional)

Service
Recommended for use under roof installations with bar joist type construction, or for attachment to the top or bottom flange of structural shapes where the vertical hanger rod is required to be offset from the edge of the flange and where the thickness of joist or flange does not exceed 3/4".

Approvals
Complies with Federal Specification A-A-1192A (Type 19 & 23), WW-H-171-E (Type 23), ANSI/MSS SP-69 and MSS SP-58 (Type 19 & 23).
UL, ULC Listed and FM Approved.

How to size
Size of clamp is determined by size of rod to be used.

Installation
Follow recommended set screw torque values per MSS-SP-69.

- Features**
- They may be attached to horizontal flanges of structural members in either the top beam or bottom beam positions.
 - Secured in place by a cup-pointed Set Screw tightened against the flange. A Jam Nut is provided for tightening the Set Screw against the Body Casting.
 - Thru tapping of the body casting permits extended adjustment of the threaded rod.
 - Can be used with Fig 89X retaining clip for seismic applications.

Ordering
Specify rod size, figure number, name of clamp and finish.

Available with oversized tapped rod hole for Hot Dip Galvanized finish.

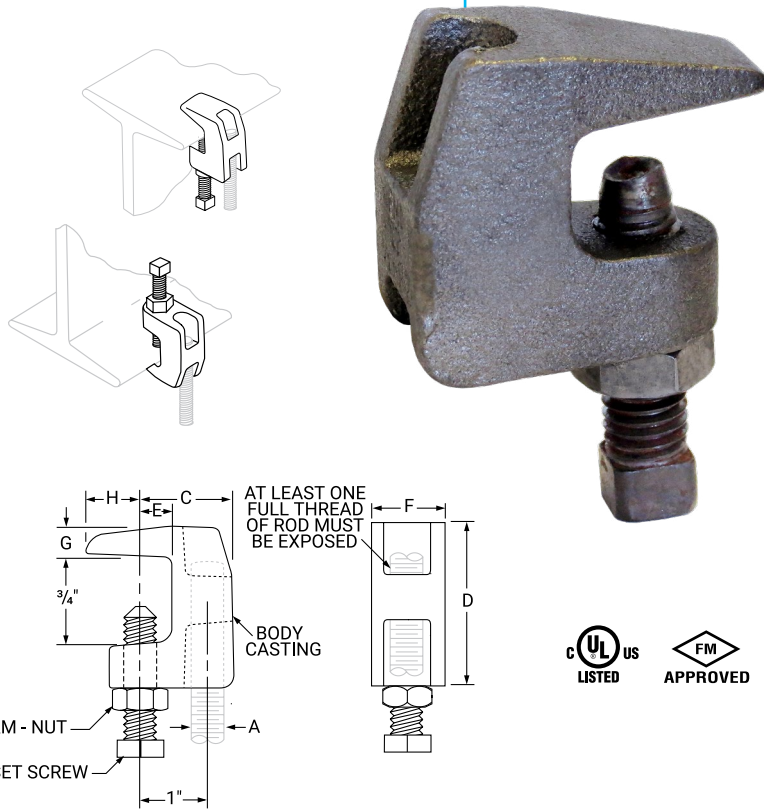

Dimensions (In) - Load (Lbs) - Torque (In-Lbs) - Weight (Lbs)

Rod Size A	Set Screw Size	Torque Value	Max Loads ■		Weight	C	D	E	F	G	H
			Top	Bottom							
In.	In.	In.-Lbs.	Lbs.	Lbs.	Lbs.	In.	In.	In.	In.	In.	In.
3/8	3/8	60	500	250	0.34	1 5/16	1 9/16	9/16	13/16	3/8	1/2
1/2	1/2	125	950	760	0.63	1 3/8	1 13/16	1/2	1 1/16	7/16	23/32

Note:
■ Maximum temperature of 450° F

PROJECT INFORMATION	APPROVAL STAMP
Project:	Approved
Address:	Approved as noted
Contractor:	Not approved
Engineer:	Remarks:
Submittal Date:	
Notes 1:	
Notes 2:	

Adjustable Swivel Ring Fig. 69

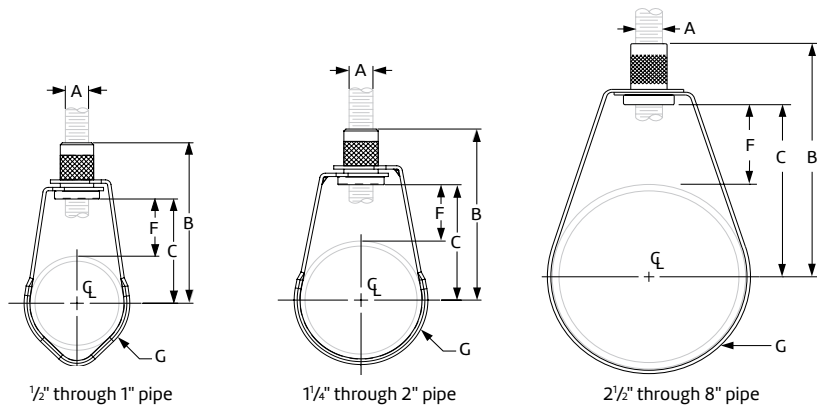

Fig. 69: Dimensions (in) • Loads (lbs) • Weight (lbs)

Pipe Size	Max Load	Weight	Rod Size A	B	C	F	G Width
1/2	300	0.10	3/8	2 7/8	2	1 9/16	5/8
3/4		0.10		2 3/4	1 7/8	1 5/16	
1		0.10		2 9/16	1 11/16	1	
1 1/4		0.10		2 5/8	1 3/4	7/8	
1 1/2		0.10		2 3/4	1 7/8		
2	525	0.11	1/2	3 1/4	2 3/8	1 1/8	3/4
2 1/2		0.20		4	2 3/4	1 5/16	
3		0.20		3 13/16	2 15/16	1 3/16	
4	650	0.30	1/2	4 11/16	3 13/16	1 9/16	3/4
5		0.54		5 5/16	4 3/8		
6	1,000	0.65	1/2	6 11/16	5 9/16	2 1/4	3/4
8		1.00		8 9/16	7 9/16	3 1/4	

Size Range: 1/2" through 8"

Material: Carbon steel

Finish: Strap is Pre-Galvanized Zinc Material. Nut is Zinc Plated.

Service: Recommended for suspension of non-insulated stationary pipe line.

Maximum Temperature: 450° F

Approvals: Complies with Federal Specification A-A-1192A (Type 10), WW-H-171-E (Type 10), and ANSI/MSS SP-58 (Type 10).

UL Listed and FM Approved (Sizes 3/4" – 8").

Features:

- 1/2" – 2" sizes designed for use with steel and CPVC piping and manufactured with FBC System Compatible oil.
- Threads are countersunk so that they cannot become burred or damaged.
- Knurled swivel nut provides vertical adjustment after piping is in place.
- Captured swivel nut in the 1/2" through 6" sizes. The capture is permanent in the bottom portion of the band, allowing the hanger to be opened during installation if desired, but not allowing the nut to fall completely out.

Ordering:

Specify size, figure number and name.

Non-captured nut also available upon request.



PROJECT INFORMATION	APPROVAL STAMP
Project:	Approved
Address:	Approved as noted
Contractor:	Not approved
Engineer:	Remarks:
Submittal Date:	
Notes 1:	
Notes 2:	