

Notifier Early Warning Fire Alarm System

Submittal Data For:

Cape Fear Valley Health – Harnett

1st & 2nd Fl Fitup Revision 4/24/2024

225 Brightwater Drive

Lillington, NC 27546

DNR(A) and DNRW Intelligent Photoelectric Duct Detectors

The Notifier DNR(A) intelligent non-relay photoelectric duct smoke detector and DNRW watertight non-relay photoelectric duct smoke detector feature a pivoting housing that fits both square and rectangular footprints capable of mounting to a round or rectangular duct.

The DNRW duct smoke detector, with its NEMA-4 rating, is listed as a watertight, UV resistant enclosure providing protection against falling dirt, rain, and windblown dust, splashing and hose directed water, allowing operators to use the detector in the most extreme environments.

These units sense smoke in the most challenging conditions, operating in airflow speeds of 100 to 4,000 feet per minute (0.5 – 20.32 m/s), temperatures of -4°F – 158°F (-20°C – 70°C), and a humidity range of 0 – 95 percent (non-condensing.)

An improved cover design isolates the sensor head, which allows for ease of maintenance. A cover tamper feature indicates a trouble signal for a removed or improperly installed sensor cover. The housing provides a 3/4-inch conduit knockout and ample space to facilitate easy wiring and mounting of a relay module.

The Notifier DNR(A) duct smoke detectors can be customized to meet local codes and specifications without additional wiring and are compatible with all previous models, including remote test accessories.

Features

- Photoelectric, integrated low-flow technology
- Air velocity rating from 100 ft/min – 4,000 ft/min (0.5 m/s – 20.32 m/s)
- Versatile mounting options: square or rectangular configuration
- Broad ranges for operating temperature (-4°F – 158°F, -20°C – 70°C) and humidity (0% – 95% non-condensing)
- Patented sampling tube installs from front or back of the detector with no tools required
- Cover tamper signal
- Increased wiring space with a newly added 3/4" conduit knockout
- Available space within housing to accommodate mounting of a relay module
- Easily accessible code wheels on sensor head (sold separately)
- Clear cover for convenient visual inspection
- Remote testing capability
- Requires com line power only
- Accommodates an addressable relay module, sold separately, (FRM-1) for applications requiring a Form-C relay

Specifications

Size: (Rectangle) 14.38 in (37 cm) Length; 5 in (12.7 cm) Width, 2.5 in (6.6 cm) Depth

Size: (Square) 7.75 in (19.7 cm) Length; 9 in (22.9 cm) Width; 2.5 in (6.35 cm) Depth

Weight: 1.6 lb (0.73 kg)

Operating Temperature Range: -4°F – 158°F (-20°C – 70°C)

Storage Temperature Range: -22°F – 158°F (-30°C – 70°C)

Operating Humidity Range: 0% – 95% relative humidity (non-condensing)

Air Duct Velocity: 100 – 4,000 ft/min (0.5 – 20.32 m/s)

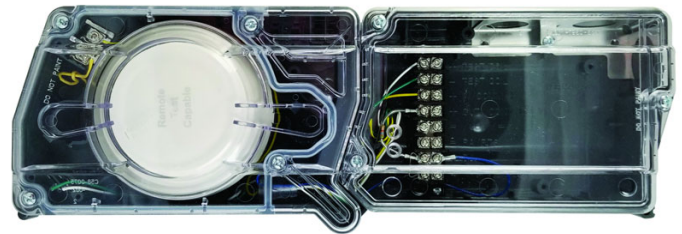

Accessories

Notifier provides system flexibility with a variety of accessories, including two remote test stations and different means of visible and audible system annunciation. As with our duct smoke detectors, all duct smoke detectors accessories are UL listed.

DNR(W) housings with a date code of 0013 or higher do not require external 24VDC for remote test applications when used with a remote-test-capable detector.

ACCESSORY CURRENT LOADS AT 24 VDC

Device	Standby	Alarm
RA100Z	0mA	12mA Max
RTS151/RTS151KEY	0mA	12mA Max

Agency Listings and Approvals

Consult product manual for lists of compatible UL-Listed devices. In some cases, certain modules may not be listed by certain approval agencies, or listing may be in process. Consult factory for latest listing status.

- **UL:** S635, S3705
- **ULC:** S635
- **CSFM:** 3240-1653:0209
- **FM approved**

Product Line Information

NOTE: "A suffix indicates ULC listed model.

DNR(A): Intelligent non-relay photoelectric low flow smoke detector housing. Requires photoelectric smoke detector (sold separately).

DNRW: Watertight intelligent non-relay photoelectric low flow duct smoke detector housing. Requires photoelectric smoke detector (sold separately). NEMA-4 rated.

FSP-951R(A)-IV: Remote test capable addressable low-profile photoelectric smoke detector; ivory; supports CLIP and FlashScan® protocols

FSP-951R(A): Remote test capable addressable low-profile photoelectric smoke detector; white; supports FlashScan protocol only

FSP-951(A)-IV: Addressable low-profile photoelectric smoke detector; ivory; supports CLIP and FlashScan protocols

FSP-951R(A): Addressable low-profile photoelectric smoke detector; white; supports FlashScan protocol only

DCOIL: Remote test coil. Required for older DNR(W) duct detector housing

DUCTCOV: Retrofit DNR cover for manufactured prior to April 2014

DUCTCOVW: Retrofit DNRW cover for manufactured prior to April 2014

DST1(A): Metal sampling tube duct width up to 1 ft (0.3m)

DST1.5(A): Metal sampling tube duct widths up to 1 ft – 2 ft (0.3 – 0.6 m)

DST3(A): Metal sampling tube duct widths up to 2 ft – 4 ft (0.6 – 1.2 m)

DST5(A): Metal sampling tube duct widths up to 4 ft – 8 ft (1.2 – 2.4 m)

DST10(A): Metal sampling tube duct widths up to 8 ft – 12 ft (2.4 – 3.7 m)

DH400OE-1: Weatherproof enclosure

ETX: Metal exhaust tube duct, width 1 ft (0.3 m)

M02-04-00: Test magnet

P48-21-00: End cap for metal sampling tubes

RA100Z(A): Remote annunciator alarm LED

RTS151(A): Remote test station

RTS151KEY(A): Remote test station with key lock

Important Notes

- DNR(W) duct detector housings with a date code of 0013 or higher do not require a DCOIL or auxiliary 24 VDC for remote test applications when used with a remote test capable detector.
- DNR(W) duct detector housings with a date code of 0012 or earlier require a DCOIL and auxiliary 24 VDC power for remote test applications.



This document is not intended to be used for installation purposes.

We try to keep our product information up-to-date and accurate.

We cannot cover all specific applications or anticipate all requirements.

All specifications are subject to change without notice.

NOTIFIER

12 Clintonville Road

Northford, CT 06472

203.484.7161

www.notifier.com

Notifier® and FlashScan® are a registered trademark of Honeywell International Inc.

©2019 by Honeywell International Inc. All rights reserved. Unauthorized use of this document is strictly prohibited.

Country of Origin: Mexico



NBG-12LX

Addressable Manual Pull Station



Intelligent/Addressable Devices

General

The Notifier NBG-12LX is a state-of-the-art, dual-action (i.e., requires two motions to activate the station) pull station that includes an addressable interface for any Notifier intelligent control panel except FireWarden series panels, and the NSP-25 panel. Because the NBG-12LX is addressable, the control panel can display the exact location of the activated manual station. This leads fire personnel quickly to the location of the alarm.

Features

- Maintenance personnel can open station for inspection and address setting without causing an alarm condition.
- Built-in bicolor LED, which is visible through the handle of the station, flashes in normal operation and latches steady red when in alarm.
- Handle latches in down position and the word “ACTIVATED” appears to clearly indicate the station has been operated.
- Captive screw terminals wire-ready for easy connection to SLC loop (accepts up to 12 AWG/3.25 mm² wire).
- Can be surface mounted (with SB-10 or SB-I/O) or semi-flush mounted. Semi-flush mount to a standard single-gang, double-gang, or 4" (10.16 cm) square electrical box.
- Smooth dual-action design.
- Meets ADAAG controls and operating mechanisms guidelines (Section 4.1.3[13]); meets ADA requirement for 5 lb. maximum activation force.
- Highly visible.
- Attractive shape and textured finish.
- Key reset.
- Includes Braille text on station handle.
- Optional trim ring (BG12TR).
- Meets UL 38, Standard for Manually Actuated Signaling Boxes.
- Up to 99 NBG-12LX stations per loop on CLIP protocol loops.
- Up to 159 NBG-12LX stations per loop on FlashScan® protocol loops.
- Dual-color LED blinks green to indicate normal on FlashScan® systems.

Construction

Shell, door, and handle are molded of durable polycarbonate material with a textured finish.

Specifications

- **Shipping Weight:** 9.6 oz. (272.15 g)
- **Normal operating voltage:** 24 VDC.
- **Maximum SLC loop voltage:** 28.0 VDC.
- **Maximum SLC standby current:** 375 µA.
- **Maximum SLC alarm current:** 5 mA.
- **Temperature Range:** 32°F to 120°F (0°C to 49°C)
- **Relative Humidity:** 10% to 93% (noncondensing)
- **For use indoors in a dry location**



The NBG-12LX
Addressable Manual Pull Station

Installation

The NBG-12LX will mount semi-flush into a single-gang, double-gang, or standard 4" (10.16 cm) square electrical outlet box, or will surface mount to the model SB-10 or SB-I/O surface backbox. If the NBG-12LX is being semi-flush mounted, then the optional trim ring (BG12TR) may be used. The BG12TR is usually needed for semi-flush mounting with 4" (10.16 cm) or double-gang boxes (not with single-gang boxes).

Operation

Pushing in, then pulling down on the handle causes it to latch in the down/activated position. Once latched, the word “ACTIVATED” (in bright yellow) appears at the top of the handle, while a portion of the handle protrudes from the bottom of the station. To reset the station, simply unlock the station with the key and pull the door open. This action resets the handle; closing the door automatically resets the switch.

Each manual station, on command from the control panel, sends data to the panel representing the state of the manual switch. Two rotary decimal switches allow address settings (1 – 159 on FlashScan® systems, 1 – 99 on CLIP systems).

Architectural/Engineering Specifications

Manual Fire Alarm Stations shall be non-coded, with a key-operated reset lock in order that they may be tested, and so designed that after actual Emergency Operation, they cannot be restored to normal except by use of a key. An operated station shall automatically condition itself so as to be visually detected as activated. Manual stations shall be constructed of red-colored polycarbonate material with clearly visible operating instructions provided on the cover. The word FIRE shall appear on the front of the stations in white letters, 1.00 inches (2.54 cm) or larger. Stations shall be suitable for surface mounting on matching backbox SB-10 or SB-I/O; or semi-flush mounting on a standard single-gang, double-gang, or

4" (10.16 cm) square electrical box, and shall be installed within the limits defined by the Americans with Disabilities Act (ADA) or per national/local requirements. Manual Stations shall be Underwriters Laboratories listed.

Manual stations shall connect with two wires to one of the control panel SLC loops. The manual station shall, on command from the control panel, send data to the panel representing the state of the manual switch. Manual stations shall provide address setting by use of rotary decimal switches.

The loop poll LED shall be clearly visible through the front of the station. The LED shall flash while in the normal condition, and stay steadily illuminated when in alarm.

Product Line Information

NBG-12LX: Dual-action addressable pull station. Includes key locking feature. (Listed for Canadian and non-Canadian applications.)

NBG-12LXSP: Spanish/English labelled version.

NBG-12LXP: Portuguese labelled version.

SB-10: Surface backbox; metal.

SB-I/O: Surface backbox; plastic.

BG12TR: Optional trim ring.

17021: Keys, set of two.

NY-Plate: New York City trim plate.

Agency Listings and Approvals

In some cases, certain modules or applications may not be listed by certain approval agencies, or listing may be in process. Consult factory for latest listing status.

- **UL/ULC Listed:** S692 (listed for Canadian and non-Canadian applications).
- **MEA:** 67-02-E.
- **CSFM:** 7150-0028:0199.
- **FDNY:** COA #6085 (NFS2-640), COA #6098 (NFS2-3030).
- **BSMI:** CI313066760047.
- **U.S. Coast Guard.**
- **Lloyd's Register.**
- **FM Approved.**

Patented: U.S. Patent No. D428,351; 6,380,846; 6,314,772; 6,632,108.

NOTIFIER® and FlashScan® are registered trademarks of Honeywell International Inc.

©2012 by Honeywell International Inc. All rights reserved. Unauthorized use of this document is strictly prohibited.



This document is not intended to be used for installation purposes.
We try to keep our product information up-to-date and accurate.
We cannot cover all specific applications or anticipate all requirements.
All specifications are subject to change without notice.



Made in the U.S. A.

For more information, contact Notifier. Phone: (203) 484-7161, FAX: (203) 484-7118.
www.notifier.com

FSP-951 Series

Intelligent Plug-In Photoelectric Smoke Detectors



Intelligent/Addressable Devices

General

The NOTIFIER FSP-951 Series intelligent plug-in smoke detectors are designed for both performance and aesthetics. A new modern, sleek, contemporary design and enhanced optical sensing chamber is engineered to sense smoke produced by a wide range of combustion sources in accordance with more stringent code standards. The FSP-951 Series detector sensitivity can be programmed in the control panel software. Sensitivity is continuously monitored and reported to the panel. Point ID capability allows each detector's address to be set with rotary, decimal address switches, providing exact detector location for selective maintenance when chamber contamination reaches an unacceptable level. Dual electronic thermistors add 135°F (57°C) fixed temperature thermal sensing on the FSP-951T. The FSP-951R is a remote test capable detector for use with DNR Series duct detector housings. FSP-951 series detectors are available for both FlashScan® and CLIP applications as designated.

Features

- New modern profile for improved aesthetics.
- Designed to meet UL268 7th Edition.
- Stable communication technique with noise immunity.
- Low standby current.
- Two-wire SLC connection.
- Compatible with FlashScan® and CLIP protocol systems.
- Rotary, decimal addressing (1-99 on CLIP systems, 1-159 on FlashScan systems).
- Optional remote, single-gang LED accessory.
- Dual LED design provides 360° viewing angle.
- Visible bi-color LEDs blink green every time the detector is addressed, and illuminate steady red on alarm (*FlashScan systems only*).
- Remote test feature from the panel.
- Walk test with address display (an address on 121 will blink the detector LED: 12-[pause]-1 (*FlashScan systems only*)).
- Built-in functional test switch activated by external magnet.
- Built-in tamper-resistant feature.
- Sealed against back pressure.
- Expanded color options.
- SEMS screws for wiring of the separate base.
- Optional relay, isolator, and sounder bases.

Specifications

Sensitivity:

- UL Applications: 0.5% to 4.0% per foot obscuration.
- ULC Applications: 0.5% to 3.5% per foot obscuration.

Size: 2.0" (5.3 cm) high; base determines diameter.

- B300-6: 6.1" (15.6 cm) diameter.
- B501: 4" (10.2 cm) diameter.

For a complete list of detector bases see DN-60981.

Shipping weight: 3.4oz (96.4g)

Operating Temperature range:

- FSP-951, 0°C to 50°C (32°F to 122°F).
- FSP-951T, 0°C to 38°C (32°F to 100°F).



FSP-951 in B300-6 Base

- FSP-951R installed in a DNR/DNRW, -20°C to 70°C (-4°F to 158°F).

UL/ULC Listed Velocity Range: 0-4000 ft/min. (1219.2 m/min.), suitable for installation in ducts.

Relative Humidity: 10%-93% noncondensing.

Thermal Ratings: Fixed-temperature setpoint 135°F (57°C).

DETECTOR SPACING AND APPLICATIONS

NOTIFIER recommends spacing detectors in compliance with NFPA 72. In low airflow applications with smooth ceiling, space detectors 30 feet (9.1m). For specific information regarding detector spacing, placement, and special applications refer to NFPA 72. *System Smoke Detector Application Guide*, document A05-1003, is available at systemsensor.com

ELECTRICAL SPECIFICATIONS

Voltage Range: 15-32 volts DC peak.

Standby Current (max. avg.): 200µA @ 24VDC (one communication every five seconds with LED enabled).

LED Current (max.): 4.5mA @ 24 VDC ("ON").

Installation

FSP-951 series plug-in detectors use a separate base to simplify installation, service, and maintenance.

Mount base (all base types) on an electrical backbox which is at least 1.5" (3.81 cm) deep. For a chart of compatible junction boxes, see DN-60981.

NOTE: 1) Because of inherent supervision provided by the SLC loop, end-of-line resistors are not required. Wiring "T-taps" or branches are permitted for Style 4 (Class "B") wiring. 2) When using relay or sounder bases, consult the ISO-X(A) installation sheet I56-1380 for device limitations between isolator modules and isolator bases.

Agency Listings and Approvals

These listings and approvals apply to the detectors specified in this document. In some cases, certain detectors or applications may not be listed by certain approval agencies, or listing may be in process. Consult factory for latest listing status.

- UL/ULC Listed: S911
- FM Approved
- CSFM: 7272-0028:0503

Product Line Information

NOTE:

- Detectors must be mounted to one of the Intelligent Bases listed below.
- "A" suffix indicates ULC Listed model.
- "IV" suffix indicates FlashScan® and CLIP device.

FSP-951: White, low-profile intelligent photoelectric sensor, FlashScan only.

FSP-951A: Same as FSP-951 but with ULC listing.

FSP-951-IV: Ivory, low-profile intelligent photoelectric sensor.

FSP-951A-IV: Same as FSP-951-IV but with ULC listing.

FSP-951T: White, same as FSP-951 but includes a built-in 135°F (57°C) fixed-temperature thermal device. FlashScan only.

FSP-951TA: Same as FSP-951T but with ULC listing.

FSP-951T-IV: Ivory, same as FSP-951T but includes a built-in 135°F (57°C) fixed-temperature thermal device.

FSP-951TA-IV: Same as FSP-951T-IV but with ULC listing.

FSP-951R: White, low-profile intelligent photoelectric sensor, remote test capable. For use with DNR/DNRW. FlashScan only.

FSP-951RA: Same as FSP-951R but with ULC listing. For use with DNRA.

FSP-951R-IV: Ivory, low-profile intelligent photoelectric sensor, remote test capable. For use with DNR/DNRW.

FSP-951RA-IV: Same as FSP-951R-IV but with ULC listing. For use with DNRA.

INTELLIGENT BASES

NOTE: For details on intelligent bases, see DN-60981

B300-6: White, 6" base, standard flanged low-profile mounting base.

B300-6-IV: Ivory, 6" base, standard flanged low-profile mounting base.

B300A-6: Same as B300-6, ULC listed.

B300A-6-IV: Ivory, 6" standard flanged low-profile mounting base, ULC listed.

B300-6-BP: Bulk pack of B300-6, package contains 10

B501-WHITE: White, 4" standard European flangeless mounting base. UL/ULC listed.

B501-BL: Black, 4" standard European flangeless mounting base. UL/ULC listed.

B501-IV: Ivory color, 4" standard European flangeless mounting base. UL/ULC listed.

B501-WHITE-BP: Bulk pack of B501-WHITE contains 10.

B224RB-WH: White, relay base.

B224RB-IV: Ivory, relay base.

B224RBA-WH: White, relay base, ULC listing.

B224RBA-IV: Ivory, relay base, ULC listing.

B224BI-WH: White, *isolator* detector base.

B224BI-IV: Ivory *isolator* detector base.

B224BIA-WH: White, *isolator* detector base, ULC listing.

B224BIA-IV: Ivory *isolator* detector base, ULC listing.

B200S-WH: White, Intelligent addressable sounder base capable of producing sound output in high or low volume with ANSI Temporal 3, ANSI Temporal 4, continuous tone, marching tone, and custom tone. Uses FlashScan protocol.

B200S-IV: Ivory, Intelligent addressable sounder base capable of producing sound output in high or low volume with ANSI Temporal 3, ANSI Temporal 4, continuous tone, marching tone, and custom tone. Uses FlashScan protocol.

B200SA-WH: Same as B200S-WH, ULC listing.

B200SA-IV: Same as B200S-IV, ULC listing.

B200SCOA-WH: White, Intelligent, programmable sounder base in English/French (required in Canada for ULC applications with SO Series detector applications).

B200SCOA-IV: Ivory Intelligent, programmable sounder base in English/French (required in Canada for ULC applications with SO Series detector applications, ULC listing).

B200S-LF-WH: White, Low Frequency Intelligent, programmable sounder base. Produces a fundamental frequency of 520 Hz +/- 10% with a square wave or its equivalent; designed to meet the NFPA 72 sleeping space requirement.

B200S-LF-IV: Ivory, Low Frequency Intelligent, programmable sounder base. Produces a fundamental frequency of 520 Hz +/- 10% with a square wave or its equivalent; designed to meet the NFPA 72 sleeping space requirement.

B200SR-WH: White, Intelligent sounder base capable of producing sound output with ANSI Temporal 3 or continuous tone. Intended for retrofit applications.

B200SR-IV: Ivory, Intelligent sounder base capable of producing sound output with ANSI Temporal 3 or continuous tone. Intended for retrofit applications.

B200SRA-WH: Same as B200SR-WH with, ULC listing.

B200SRA-IV: Same as B200SR-IV in Ivory color, ULC listing.

B200SR-LF-WH: White, Low Frequency Intelligent, programmable sounder base. Produces a fundamental frequency of 520 Hz +/- 10% with a square wave or its equivalent; designed to meet the NFPA 72 sleeping space requirement. Intended for retrofit applications.

B200SR-LF-IV: Ivory, Low Frequency Intelligent, programmable sounder base. Produces a fundamental frequency of 520 Hz +/- 10% with a square wave or its equivalent; designed to meet the NFPA 72 sleeping space requirement. Intended for retrofit applications.

MOUNTING KITS AND ACCESSORIES

TR300: White, replacement flange for B210LP(A) base.

TR300-IV: Ivory, replacement flange for B210LP(A) base.

RA100Z(A): Remote LED annunciator. 3 – 32 VDC. Mounts to a U.S. single-gang electrical box. For use with B501(A) and B300(A)-6.

M02-04-00: Test magnet.

M02-09-00: Test magnet with telescoping handle.

©2018 by Honeywell International Inc. All rights reserved. Unauthorized use of this document is strictly prohibited.



This document is not intended to be used for installation purposes.
We try to keep our product information up-to-date and accurate.
We cannot cover all specific applications or anticipate all requirements.
All specifications are subject to change without notice.

For more information, contact Notifier. Phone: (800) 627-3473, FAX: (203) 484-7118.
www.notifier.com

Intelligent Bases Standard, Relay, Isolator, Sounder, and Low-Frequency Sounder Bases

General

Intelligent FlashScan® and CLIP detector mounting bases are available to install NOTIFIER detectors in any application. Bases are available for the new, modern looking aesthetically pleasing 900 series addressable detectors, as well as previous series detectors. Both flanged and flangeless bases are available.

To meet code and specific application requirements **Relay, Isolator and Sounder Bases** versions are available. Relay bases provide one form-C contact for auxiliary functions such as door closure and elevator recall. Isolator bases allow loops to continue to operate under fault conditions and automatically restore when the fault is removed. Sounder bases are available in temporal and non-temporal pattern versions depending on whether the signal is to be used for evacuation purposes. Low frequency sounder bases are UL listed for low frequency operation and comply with NFPA 72 requirements for sleeping spaces.

Specifications

NOTE: Specifications applies to all model variants "A", "-BL", "-LF", "-IV". See Product Line Information for detailed model description.

Diameter

- B501: 4" (10.16 cm) diameter.
- B300-6: 6.1" (15.49 cm) diameter.
- B224RI, B224RB, B210LP: 6.2" (15.748 cm) diameter.
- B200S, B200SR, B200SCOA: 6.875" (17.46 cm) diameter.

Wire gauge:

- B224BI, B224RB: 14 to 24 AWG.
- B300-6, B210LP, B501, B200S, B200SR, B200SCOA: 12 to 24 AWG

Temperature range:

- B224BI, B224RB, B200S, B200SR, B200SCOA: 32°F to 120°F (0°C to 49°C).
- B300-6, B210LP, B501: -4°F to 150°F (-20°C to 66°C).

Humidity range: 10% to 93% RH, non-condensing.

System temperature and humidity ranges: This system meets NFPA requirements for operation at 0°C to 49°C (32°F to 120°F); and at a relative humidity (noncondensing) of 85% at 30°C (86°F) per NFPA, and 93% ± 2% at 32°C ± 2°C (89.6°F ± 1.1°F) per ULC. However, the useful life of the system's standby batteries and the electronic components may be adversely affected by extreme temperature ranges and humidity. Therefore, it is recommended that this system and all peripherals be installed in an environment with a nominal room temperature of 15°C to 27°C (60°F to 80°F).

Electrical Ratings

FOR B200 SERIES BASES:

External supply voltage: 16 to 33 VDC (VFWR)

Standby current:

500 µA maximum.

Alarm current:

- B200S(A)(-IV)
 - 35 mA maximum at high-volume setting.
 - 15 mA maximum at low-volume setting.
- B200S-LF(-IV), High-volume setting:



Flangeless Mounting Base
B501(A)



Flanged Mounting Base
B210LP(A)



Sounder Base
B200S(A), B200SR(A),
B200SCOA



Relay Base
B224RB(A)



Low-Frequency
Sounder
Base B200S-LF,
B200SR-LF



Standard Flanged
Low-Profile Base
B300-6

- 70 mA maximum @ 33.0 VDC.
- 90 mA maximum @ 24.0 VDC.
- 140 mA maximum @ 16.0 VDC.
- B200S-LF(-IV), Low-volume setting:
 - 15 mA maximum @ 33.0 VDC.
 - 20 mA maximum @ 24.0 VDC.
 - 25 mA maximum @ 16.0 VDC.
- B200SR(A)(-IV)
 - 35 mA maximum.
- B200SR-LF(-IV)
 - 65 mA maximum @ 33.0 VDC.
 - 90 mA maximum @ 24.0 VDC.
 - 125 mA maximum @ 16.0 VDC.
- B200SCOA(-IV)
 - 40mA Max. (DC)
 - 70mA Max. (FWR)

SLC operating voltage: 15 to 32 VDC.

SLC standby current: See applicable sensor specification.

Sound output:

- B200S(A)(-LF)(-IV), high-volume*: Greater than 85 dBA minimum.
- B200S(A)(-LF)(-IV), low-volume*: Greater than 75 dBA minimum.
- B200SR(A)(-LF)(-IV)*: Greater than 85 dBA minimum.
- B200SCOA(-IV), high-volume**: Greater than 87 dBA minimum.
- B200SCOA(-IV), low-volume**: Greater than 85 dBA minimum

*Measured in a UL reverberant room at 10 feet, 24 Volts (continuous tone)
**Measured in a ULC anechoic room at 10 feet, 24 Volts continuous tone)

FOR B224BI, B224RB (A) (-IV):

Operating voltage: 15 to 32 VDC (powered by SLC).

Standby ratings: <500 µA maximum @ 24 VDC.

Set time (B224RB(A)-(-IV) only): short delay 55 to 90 msec; long delay 6 to 9 seconds.

Reset time (B224RB(A)-(-IV) only): 20 msec maximum.

Relay characteristics (B224RB(A)-(-IV) only): two-coil latching relay; one Form-C contact; ratings (UL/CSA): 0.9 A @ 125 VAC, 0.9 A @ 110 VDC, and 3.0 A @ 30 VDC.

Product Line Information

INTELLIGENT BASES

NOTE: "A" suffix indicates ULC Listed model.

NOTE: "-IV" suffix indicates Ivory color model.

NOTE: "-BL" suffix indicates Black color model.

B210LP: Flanged mounted base.

B210LPA: Same as B210LP ULC listed.

B210LPBP: Bulk pack of B210LP contains 10.

B300-6: White, 6" base, standard flanged low-profile mounting base. (CSFM: 7300-1653:0109)

B300A-6: Same as B300-6, ULC listed.

B300-6-BP: Bulk pack of B300-6, package contains 10

B300-6-IV: Ivory, 6" base, standard flanged low-profile mounting base. (CSFM: 7300-1653:0109)

B300A-6-IV: Ivory, 6" standard flanged low-profile mounting base, ULC listed.

B501-WHITE: White, 4" standard European flangeless mounting base. UL/ULC listed. (CSFM: 7300-1653:0109)

B501-WHITE-BP: Bulk pack of B501-WHITE contains 10.

B501-BL: Black, 4" standard European flangeless mounting base. UL/ULC listed. (CSFM: 7300-1653:0109)

B501-IV: Ivory color, 4" standard European flangeless mounting base. UL/ULC listed. (CSFM: 7300-1653:0109)

B224RB-WH: White, relay base. (CSFM: 7300-1653:0216)

B224RB-IV: Ivory, relay base. (CSFM: 7300-1653:0216)

B224RBA-WH: White, relay base, ULC listing.

B224RBA-IV: Ivory, relay base, ULC listing.

B224BI-WH: White, *isolator* detector base. (CSFM: 7300-1653:0216)

B224BI-IV: Ivory *isolator* detector base. (CSFM: 7300-1653:0216)

B224BIA-WH: White, *isolator* detector base, ULC listing.

B224BIA-IV: Ivory *isolator* detector base, ULC listing.

B200S-WH: White, Intelligent addressable sounder base capable of producing sound output in high or low volume with ANSI Temporal 3, ANSI Temporal 4, continuous tone, marching tone, and custom tone. Uses FlashScan protocol. (CSFM: 7300-1653:0213)

B200S-IV: Ivory, Intelligent addressable sounder base capable of producing sound output in high or low volume with ANSI Temporal 3, ANSI Temporal 4, continuous tone, marching tone, and custom tone. Uses FlashScan protocol. (CSFM: 7300-1653:0213)

B200SA-WH: Same as B200S-WH, ULC listing.

B200SA-IV: Same as B200S-IV, ULC listing.

B200SCOA-WH: White, Intelligent, programmable sounder base in English/French (required in Canada for ULC applications with SO Series detector applications).

B200SCOA-IV: Ivory Intelligent, programmable sounder base in English/French (required in Canada for ULC applications with SO Series detector applications, ULC listing).

B200S-LF-WH: White, Low Frequency Intelligent, programmable sounder base. Produces a fundamental frequency of 520 Hz +/- 10% with a square wave or its equivalent; designed to meet the NFPA 72 sleeping space requirement. (CSFM: 7300-1653:0238)

B200S-LF-IV: Ivory, Low Frequency Intelligent, programmable sounder base. Produces a fundamental frequency of 520 Hz +/- 10% with a square wave or its equivalent; designed to meet the NFPA 72 sleeping space requirement. (CSFM: 7300-1653:0238)

B200SR-WH: White, Intelligent sounder base capable of producing sound output with ANSI Temporal 3 or continuous tone. Intended for retrofit applications. (CSFM: 7300-1653:0213)

B200SR-IV: Ivory, Intelligent sounder base capable of producing sound output with ANSI Temporal 3 or continuous tone. Intended for retrofit applications. (CSFM: 7300-1653:0213)

B200SRA-WH: Same as B200SR-WH with, ULC listing.

B200SRA-IV: Same as B200SR-IV in Ivory color, ULC listing.

B200SR-LF-WH: White, Low Frequency Intelligent, programmable sounder base. Produces a fundamental frequency of 520 Hz +/- 10% with a square wave or its equivalent; designed to meet the NFPA 72 sleeping space requirement. Intended for retrofit applications. (CSFM: 7300-1653:0238)

B200SR-LF-IV: Ivory, Low Frequency Intelligent, programmable sounder base. Produces a fundamental frequency of 520 Hz +/- 10% with a square wave or its equivalent; designed to meet the NFPA 72 sleeping space requirement. Intended for retrofit applications. (CSFM: 7300-1653:0238)

MOUNTING KITS AND ACCESSORIES

TR300: White, replacement flange for B210LP(A) base.

TR300-IV: Ivory, replacement flange for B210LP(A) base.

RA100Z(A): Remote LED annunciator. 3 – 32 VDC. Mounts to a U.S. single-gang electrical box. For use with B501(A) and B300(A)-6.

M02-04-00: Test magnet.

M02-09-00: Test magnet with telescoping handle.

XR2B: Detector removal tool. Allows installation and/or removal of detector heads from bases in high ceiling applications.

XP-4: Extension pole for XR2B. Comes in three 5-foot (1.524m) sections.

T55-127-010: Detector removal tool without pole.

CK300: White, detector color kit. Pack of 10.

CK300-IR: White, detector color kit for use with FPTI and FCO Series detectors. Pack of 10.

CK300-IV: Ivory, detector color kit. Pack of 10.

CK300-IR-IV: Ivory, detector color kit for use with FPTI and FCO Series detectors. Pack of 10.

CK300-BL: Black, detector color kit. Pack of 10.

CK300-IR-BL: Black, detector color kit for use with FPTI and FCO Series detectors. Pack of 10.

Agency Listings and Approvals

The listings and approvals below apply to intelligent bases as noted. In some cases, certain modules or applications may not be listed by certain approval agencies, or listing may be in process. Consult factory for latest listing status.

- **UL Listed:** S911, S1115
- **ULC Listed:** S911, S1115.
- **FM Approved.**
- **MEA:** 22-95-E, 205-94-E Vol. 2; 257-06-E
- **CSFM:** 7270-0028-0502, 7272-0028:0503, 7300-1653:0126, 7135-1653:0213, 7300-1653:0109

Junction Box Selection Guide

Base Models	Single Gang	3.5" Oct.	4.0" Oct.	4.0" Sq.	4.0" Sq. with 3.0" mud ring	50 mm	60 mm	70 mm	75 mm
B200S, B200SR, B200SCOA	Yes	Yes	Yes	Yes	Yes	No	No	No	No
B501	No	Yes	No	No	Yes	Yes	Yes	Yes	No
B210LP	Yes	Yes	Yes	Yes	Yes	No	No	No	No
B224RB	No	Yes	Yes	Yes	No	No	Yes	Yes	Yes
B224BI	No	Yes	Yes	Yes	No	No	No	Yes	Yes

NOTE: Box depth contingent on base and wire size.

Refer to National Electric Code or applicable local codes for appropriate recommendations.

NOTE: Applies to all model variants "A", "-BL", "-LF", "-IV". See Product Line Information for detailed model description.



This document is not intended to be used for installation purposes.
We try to keep our product information up-to-date and accurate.
We cannot cover all specific applications or anticipate all requirements.
All specifications are subject to change without notice.

FlashScan®, NOTIFIER® and System Sensor® are registered trademarks of Honeywell International Inc.
©2018 by Honeywell International Inc. All rights reserved.
Unauthorized use of this document is strictly prohibited.

Country of Origin: USA

NOTIFIER
12 Clintonville Road
Northford, CT 06472
203.484.7161
www.notifier.com



FCM-1(A) & FRM-1(A) Series

Control and Relay Modules



Intelligent / Addressable Devices

General

FCM-1(A) Control Module: The FCM-1(A) Addressable Control Module provides Notifier intelligent fire alarm control panels a circuit for Notification Appliances (horns, strobes, speakers, etc.). Addressability allows the FCM-1(A) to be activated, either manually or through panel programming, on a select (zone or area of coverage) basis.

FRM-1(A) Relay Module: The FRM-1(A) Addressable Relay Module provides the system with a dry-contact output for activating a variety of auxiliary devices, such as fans, dampers, control equipment, etc. Addressability allows the dry contact to be activated, either manually or through panel programming, on a select basis.

FlashScan® (U.S. Patent 5,539,389) is a communication protocol developed by NOTIFIER Engineering that greatly enhances the speed of communication between analog intelligent devices. Intelligent devices communicate in a grouped fashion. If one of the devices within the group has new information, the panel CPU stops the group poll and concentrates on single points. The net effect is response speed greater than five times that of other designs.



FCM-1(A)

Features

- Built-in type identification automatically identifies these devices to the control panel.
- Internal circuitry and relay powered directly by two-wire SLC loop. The FCM-1(A) module requires power (for horns, strobes, etc.), or audio (for speakers).
- Integral LED “blinks” green each time a communication is received from the control panel and turns on in steady red when activated.
- LED blink may be deselected globally (affects all devices).
- High noise immunity (EMF/RFI).
- The FCM-1(A) may be used to switch 24-volt NAC power, audio (up to 70.7 Vrms).
- Wide viewing angle of LED.
- SEMS screws with clamping plates for wiring ease.
- Direct-dial entry of address 01– 159 for FlashScan loops, 01 – 99 for CLIP mode loops.
- Speaker, and audible/visual applications may be wired for Class B or A (Style Y or Z).

Applications

The FCM-1(A) is used to switch 24 VDC audible/visual power, high-level audio (speakers). The FRM-1(A) may be programmed to operate dry contacts for applications such as door holders or Air Handling Unit shutdown, and to reset four-wire smoke detector power.

NOTE: Refer to the SLC Manual (PN 51253) for details regarding releasing applications with the FCM-1(A). Refer to the FCM-1-REL datasheet (DN-60390) for new FlashScan® releasing applications.

Construction

- The face plate is made of off-white heat-resistant plastic.
- Controls include two rotary switches for direct-dial entry of address (01-159).

- The FCM-1(A) is configured for a single Class B (Style Y) or Class A (Style Z) Notification Appliance Circuit.
- The FRM-1(A) provides two Form-C dry contacts that switch together.

Operation

Each FCM-1(A) or FRM-1(A) uses one of 159 possible module addresses on a SLC loop (99 on CLIP loops). It responds to regular polls from the control panel and reports its type and status, including the open/normal/short status of its Notification Appliance Circuit (NAC). The LED blinks with each poll received. On command, it activates its internal relay. The FCM-1(A) supervises Class B (Style Y) or Class A (Style Z) notification or control circuits.

Upon code command from the panel, the FCM-1(A) will disconnect the supervision and connect the external power supply in the proper polarity across the load device. The disconnection of the supervision provides a positive indication to the panel that the control relay actually turned ON. The external power supply is always relay isolated from the communication loop so that a trouble condition on the external power supply will never interfere with the rest of the system.

Rotary switches set a unique address for each module. The address may be set before or after mounting. The built-in TYPE CODE (not settable) will identify the module to the control panel, so as to differentiate between a module and a sensor address.

Specifications for FCM-1(A)

Normal operating voltage: 15 to 32 VDC.

Maximum current draw: 6.5 mA (LED on).

Average operating current: 350 μ A direct poll, 375 μ A group poll with LED flashing, 485 μ A Max. (LED flashing, NAC shorted.)

Maximum NAC Line Loss: 4 VDC.

External supply voltage (between Terminals T10 and T11): Maximum (NAC): Regulated 24 VDC; Maximum (Speakers): 70.7 V RMS, 50W.

Drain on external supply: 1.7 mA maximum using 24 VDC supply; 2.2 mA Maximum using 80 VRMS supply.

Max NAC Current Ratings: For class B wiring system, the current rating is 3A; For class A wiring system, the current rating is 2A.

Temperature range: 32°F to 120°F (0°C to 49°C).

Humidity range: 10% to 93% non-condensing.

Dimensions: 4.5" (114.3 mm) high x 4" (101.6 mm) wide x 1.25" (31.75 mm) deep. Mounts to a 4" (101.6 mm) square x 2.125" (53.975 mm) deep box.

Accessories: SMB500 Electrical Box; CB500 Barrier

Specifications for FRM-1(A)

Normal operating voltage: 15 to 32 VDC.

Maximum current draw: 6.5 mA (LED on).

Average operating current: 230 µA direct poll; 255 µA group poll.

EOL resistance: not used.

Temperature range: 32°F to 120°F (0°C to 49°C).

Humidity range: 10% to 93% non-condensing.

Dimensions: 4.5" (114.3 mm) high x 4" (101.6 mm) wide x 1.25" (31.75 mm) deep. Mounts to a 4" (101.6 mm) square x 2.125" (53.975 mm) deep box.

Accessories: SMB500 Electrical Box; CB500 Barrier

Agency Listings and Approvals

In some cases, certain modules may not be listed by certain approval agencies, or listing may be in process. Consult factory for latest listing status.

- **UL:** S635
- **ULC:** S3705 (A version only)
- **FM Approved**
- **CSFM:** 7300-0028:0219
- **MEA:** 14-00-E
- **FDNY:** COA #6067, #6065

Contact Ratings for FRM-1(A)

Current Rating	Maximum Voltage	Load Description	Application
3 A	30 VDC	Resistive	Non-Coded
2 A	30 VDC	Resistive	Coded
.9 A	110 VDC	Resistive	Non-Coded
.9 A	125 VDC	Resistive	Non-Coded
.5 A	30 VDC	Inductive (L/R=5ms)	Coded
1 A	30 VDC	Inductive (L/R=2ms)	Coded
.3 A	125 VAC	Inductive (PF=0.35)	Non-Coded
1.5 A	25 VAC	Inductive (PF=0.35)	Non-Coded
.7 A	70.7 VAC	Inductive (PF=0.35)	Non-Coded
2 A	25 VAC	Inductive (PF=0.35)	Non-Coded

NOTE: Maximum (Speakers): 70.7 V RMS, 50 W

Product Line Information

NOTE: "A" suffix indicates ULC Listed model.

FCM-1(A): Intelligent Addressable Control Module.

FRM-1(A): Intelligent Addressable Relay Module.

A2143-20: Capacitor, required for Class A (Style Z) operation of speakers.

SMB500: Optional Surface-Mount Backbox.

CB500: Control Module Barrier — required by UL for separating power-limited and non-power limited wiring in the same junction box as FCM-1(A).

NOTE: For installation instructions, see the following documents:

- *FCM-1(A) Installation document I56-1169.*
- *FRM-1(A) Installation document I56-3502.*
- *Notifier SLC Wiring Manual, document 51253.*

Notifier® and FlashScan® are registered trademarks of Honeywell International Inc.

©2011 by Honeywell International Inc. All rights reserved. Unauthorized use of this document is strictly prohibited.



This document is not intended to be used for installation purposes.
We try to keep our product information up-to-date and accurate.
We cannot cover all specific applications or anticipate all requirements.
All specifications are subject to change without notice.



Made in the U.S. A.

For more information, contact Notifier. Phone: (203) 484-7161, FAX: (203) 484-7118.
www.notifier.com

FMM-1(A), FMM-101(A), FZM-1(A) & FDM-1(A)

Monitor Modules with FlashScan®



Intelligent/Addressable Devices

General

Four different monitor modules are available for Notifier's intelligent control panels for a variety of applications. Monitor modules supervise a circuit of dry-contact input devices, such as conventional heat detectors and pull stations, or monitor and power a circuit of two-wire smoke detectors (FZM-1(A)).

FMM-1(A) is a standard-sized module (typically mounts to a 4" [10.16 cm] square box) that supervises either a Style D (Class A) or Style B (Class B) circuit of dry-contact input devices.

FMM-101(A) is a miniature monitor module a mere 1.3" (3.302 cm) H x 2.75" (6.985 cm) W x 0.65" (1.651 cm) D that supervises a Style B (Class B) circuit of dry-contact input devices. Its compact design allows the FMM-101(A) to be mounted in a single-gang box behind the device it monitors.

FZM-1(A) is a standard-sized module that monitors and supervises compatible two-wire, 24 volt, smoke detectors on a Style D (Class A) or Style B (Class B) circuit.

FDM-1(A) is a standard-sized dual monitor module that monitors and supervises two independent two-wire Style B (Class B) dry-contact initiating device circuits (IDCs) at two separate, consecutive addresses in intelligent, two-wire systems.

FlashScan® (U.S. Patent 5,539,389) is a communication protocol developed by NOTIFIER that greatly increases the speed of communication between analog intelligent devices. Intelligent devices communicate in a grouped fashion. If one of the devices within the group has new information, the panel CPU stops the group poll and concentrates on single points. The net effect is response speed greater than five times that of other communication protocols.

FMM-1(A) Monitor Module

- Built-in type identification automatically identifies this device as a monitor module to the control panel.
- Powered directly by two-wire SLC loop. No additional power required.
- High noise (EMF/RFI) immunity.
- SEMS screws with clamping plates for ease of wiring.
- Direct-dial entry of address: 01 – 159 on FlashScan loops; 01 – 99 on CLIP loops.
- LED flashes green during normal operation (programmable option) and latches on steady red to indicate alarm.

The FMM-1(A) Monitor Module is intended for use in intelligent, two-wire systems, where the individual address of each module is selected using the built-in rotary switches. It provides either a two-wire or four-wire fault-tolerant Initiating Device Circuit (IDC) for normally-open-contact fire alarm and supervisory devices. The module has a panel-controlled LED indicator. The FMM-1(A) can be used to replace MMX-1(A) modules in existing systems.

FMM-1(A) APPLICATIONS

Use to monitor a zone of four-wire smoke detectors, manual fire alarm pull stations, waterflow devices, or other normally-

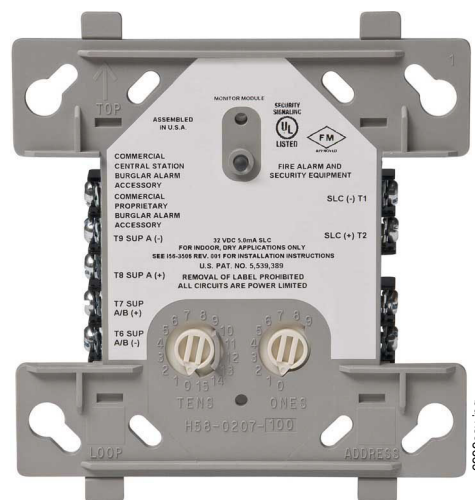

FMM-1(A) (Type H)

open dry-contact alarm activation devices. May also be used to monitor normally-open supervisory devices with special supervisory indication at the control panel. Monitored circuit may be wired as an NFPA Style B (Class B) or Style D (Class A) Initiating Device Circuit. A 47K Ohm End-of-Line Resistor (provided) terminates the Style B circuit. No resistor is required for supervision of the Style D circuit.

FMM-1(A) OPERATION

Each FMM-1(A) uses one of the available module addresses on an SLC loop. It responds to regular polls from the control panel and reports its type and the status (open/normal/short) of its Initiating Device Circuit (IDC). A flashing LED indicates that the module is in communication with the control panel. The LED latches steady on alarm (subject to current limitations on the loop).

FMM-1(A) SPECIFICATIONS

Nominal operating voltage: 15 to 32 VDC.

Maximum current draw: 5.0 mA (LED on).

Average operating current: 375 µA (LED flashing), 1 communication every 5 seconds, 47k EOL.

Maximum IDC wiring resistance: 1500 Ohms.

Maximum IDC Voltage: 11 Volts.

EOL resistance: 47K Ohms.

Temperature range: 32°F to 120°F (0°C to 49°C).

Humidity range: 10% to 93% noncondensing.

Dimensions: 4.5" (11.43 cm) high x 4" (10.16 cm) wide x 1.25" (3.175 cm) deep. Mounts to a 4" (10.16 cm) square x 2.125" (5.398 cm) deep box.

FMM-101(A) Mini Monitor Module

- Built-in type identification automatically identifies this device as a monitor module to the panel.
- Powered directly by two-wire SLC loop. No additional power required.
- High noise (EMF/RFI) immunity.
- Tinned, stripped leads for ease of wiring.
- Direct-dial entry of address: 01 – 159 on FlashScan loops; 01 – 99 on CLIP loops.

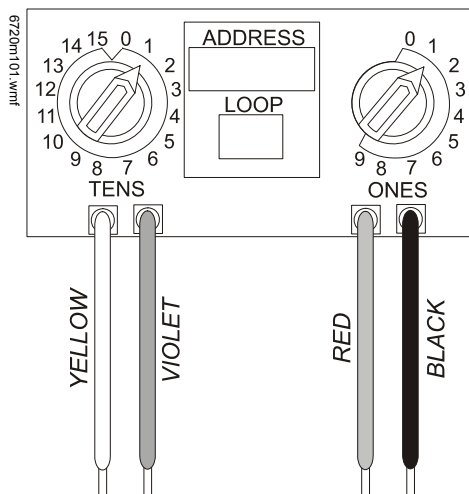

The FMM-101(A) Mini Monitor Module can be installed in a single-gang junction directly behind the monitored unit. Its small size and light weight allow it to be installed without rigid mounting. The FMM-101(A) is intended for use in intelligent, two-wire systems where the individual address of each module is selected using rotary switches. It provides a two-wire initiating device circuit for normally-open-contact fire alarm and security devices. The FMM-101(A) can be used to replace MMX-101(A) modules in existing systems.

FMM-101(A) APPLICATIONS

Use to monitor a single device or a zone of four-wire smoke detectors, manual fire alarm pull stations, waterflow devices, or other normally-open dry-contact devices. May also be used to monitor normally-open supervisory devices with special supervisory indication at the control panel. Monitored circuit/device is wired as an NFPA Style B (Class B) Initiating Device Circuit. A 47K Ohm End-of-Line Resistor (provided) terminates the circuit.

FMM-101(A) OPERATION

Each FMM-101(A) uses one of the available module addresses on an SLC loop. It responds to regular polls from the control panel and reports its type and the status (open/normal/short) of its Initiating Device Circuit (IDC).

FMM-101(A) SPECIFICATIONS

Nominal operating voltage: 15 to 32 VDC.

Average operating current: 350 μ A, 1 communication every 5 seconds, 47k EOL; 600 μ A Max. (Communicating, IDC Shorted).

Maximum IDC wiring resistance: 1500 Ohms.

Maximum IDC Voltage: 11 Volts.

Maximum IDC Current: 450 μ A.

EOL resistance: 47K Ohms.

Temperature range: 32°F to 120°F (0°C to 49°C).

Humidity range: 10% to 93% noncondensing.

Dimensions: 1.3" (3.302 cm) high x 2.75" (6.985 cm) wide x 0.65" (1.651 cm) deep.

Wire length: 6" (15.24 cm) minimum.

FZM-1(A) Interface Module

- Supports compatible two-wire smoke detectors.
- Supervises IDC wiring and connection of external power source.
- High noise (EMF/RFI) immunity.
- SEMS screws with clamping plates for ease of wiring.
- Direct-dial entry of address: 01 – 159 on FlashScan loops, 01 – 99 on CLIP loops.
- LED flashes during normal operation; this is a programmable option.
- LED latches steady to indicate alarm on command from control panel.

The FZM-1(A) Interface Module is intended for use in intelligent, addressable systems, where the individual address of each module is selected using built-in rotary switches. This module allows intelligent panels to interface and monitor two-wire conventional smoke detectors. It transmits the status (normal, open, or alarm) of one full zone of conventional detectors back to the control panel. All two-wire detectors being monitored must be UL compatible with the module. The FZM-1(A) can be used to replace MMX-2(A) modules in existing systems.

FZM-1(A) APPLICATIONS

Use the FZM-1(A) to monitor a zone of two-wire smoke detectors. The monitored circuit may be wired as an NFPA Style B (Class B) or Style D (Class A) Initiating Device Circuit. A 3.9 K Ohm End-of-Line Resistor (provided) terminates the end of the Style B or D (class B or A) circuit (maximum IDC loop resistance is 25 Ohms). Install ELR across terminals 8 and 9 for Style D application.

FZM-1(A) OPERATION

Each FZM-1(A) uses one of the available module addresses on an SLC loop. It responds to regular polls from the control panel and reports its type and the status (open/normal/short) of its Initiating Device Circuit (IDC). A flashing LED indicates that the module is in communication with the control panel. The LED latches steady on alarm (subject to current limitations on the loop).

FZM-1(A) SPECIFICATIONS

Nominal operating voltage: 15 to 32 VDC.

Maximum current draw: 5.1 mA (LED on).

Maximum IDC wiring resistance: 25 Ohms.

Average operating current: 270 μ A, 1 communication and 1 LED flash every 5 seconds, 3.9k eol.

EOL resistance: 3.9K Ohms.

External supply voltage (between Terminals T10 and T11):

- DC voltage: 24 volts power limited.
- Ripple voltage: 0.1 Vrms maximum.
- Current: 90 mA per module maximum.

Temperature range: 32°F to 120°F (0°C to 49°C).

Humidity range: 10% to 93% noncondensing.

Dimensions: 4.5" (11.43 cm) high x 4" (10.16 cm) wide x 1.25" (3.175 cm) deep. Mounts to a 4" (10.16 cm) square x 2.125" (5.398 cm) deep box.

FDM-1(A) Dual Monitor Module

The FDM-1(A) Dual Monitor Module is intended for use in intelligent, two-wire systems. It provides two independent two-wire initiating device circuits (IDCs) at two separate, consecutive addresses. It is capable of monitoring normally open contact fire alarm and supervisory devices; or either normally open or normally closed security devices. The module has a single panel-controlled LED.

NOTE: The FDM-1(A) provides two Style B (Class B) IDC circuits ONLY. Style D (Class A) IDC circuits are NOT supported in any application.

FDM-1(A) SPECIFICATIONS

Normal operating voltage range: 15 to 32 VDC.

Maximum current draw: 6.4 mA (LED on).

Average operating current: 750 μ A (LED flashing).

Maximum IDC wiring resistance: 1,500 Ohms.

Maximum IDC Voltage: 11 Volts.

Maximum IDC Current: 240 μ A

EOL resistance: 47K Ohms.

Temperature range: 32° to 120°F (0° to 49°C).

Humidity range: 10% to 93% (non-condensing).

Dimensions: 4.5" (11.43 cm) high x 4" (10.16 cm) wide x 1.25" (3.175 cm) deep. Mounts to a 4" (10.16 cm) square x 2.125" (5.398 cm) deep box.

FDM-1(A) AUTOMATIC ADDRESSING

The FDM-1(A) automatically assigns itself to two addressable points, starting with the original address. For example, if the FDM-1(A) is set to address "26", then it will automatically assign itself to addresses "26" and "27".

NOTE: "Ones" addresses on the FDM-1(A) are 0, 2, 4, 6, or 8 only. Terminals 6 and 7 use the first address, and terminals 8 and 9 use the second address.



CAUTION:

Avoid duplicating addresses on the system.

Installation

FMM-1(A), FZM-1(A), and FDM-1(A) modules mount directly to a standard 4" (10.16 cm) square, 2.125" (5.398 cm) deep, electrical box. They may also be mounted to the SMB500 surface-mount box. Mounting hardware and installation instructions are provided with each module. All wiring must conform to applicable local codes, ordinances, and regulations. These modules are intended for power-limited wiring only.

The FMM-101(A) module is intended to be wired and mounted without rigid connections inside a standard electrical box. All wiring must conform to applicable local codes, ordinances, and regulations.

Agency Listings and Approvals

In some cases, certain modules may not be listed by certain approval agencies, or listing may be in process. Consult factory for latest listing status.

- **UL:** S635.
- **ULC:** S635.
- **FM Approved.**
- **CSFM:** 7300-0028:0219, 7165-0028:0224, 7165-0028:0243.
- **MEA:** 457-99-E.
- **U.S. Coast Guard:** 161.002/50/0 (NFS2-640, NFS2-320, NFS2-3030).
- **Lloyd's Register:** 11/600013 (NFS2-640, NFS2-320, NFS2-3030).
- **Fire Dept. of New York:** COA #6121 (NFS2-640, NFS-320), COA# 6114 (NFS2-3030).

Product Line Information

NOTE: "A" suffix indicates ULC-listed model.

FMM-1(A): Monitor module.

FMM-101(A): Monitor module, miniature.

FZM-1(A): Monitor module, two-wire detectors.

FDM-1(A): Monitor module, dual, two independent Class B circuits.

SMB500: Optional surface-mount backbox.

NOTE: See installation instructions and refer to the SLC Wiring Manual, PN 51253.

FlashScan® and NOTIFIER® are registered trademarks and FireWatch™ is a trademark of Honeywell International Inc.
©2015 by Honeywell International Inc. All rights reserved. Unauthorized use of this document is strictly prohibited.



This document is not intended to be used for installation purposes.
We try to keep our product information up-to-date and accurate.
We cannot cover all specific applications or anticipate all requirements.
All specifications are subject to change without notice.

For more information, contact Notifier. Phone: (203) 484-7161, FAX: (203) 484-7118.
www.notifier.com

Duct Smoke Detector Accessories

for Notifier/System Sensor Products



Miscellaneous

General

Duct smoke detector accessories add functionality to the duct smoke system by allowing quick, convenient inspections at eye level and effective audible and visual notification options. All System Sensor duct smoke detectors and accessories are UL listed.

Specifications

APA151 PIEZO ANNUNCIATOR

The **APA151** piezo annunciator, which replaces the APA451 with a new, improved look, provides an audible alarm signal, a red LED to indicate alarm status, and a green LED to indicate power status. It is intended for use with System Sensor 4-wire conventional duct smoke detector applications without a system control panel, to comply with NFPA 90A.



APA151.wmf

APA151 Piezo Annunciator	
Voltage	Regulated 24 VDC
Operating Voltage	16 to 33 VDC
Maximum Alarm Current	30 mA
Temperature Range	32°F to 120°F (0°C to 49°C)
Relative Humidity	10 to 93%, non-condensing
Wire Gauge	12 to 18 AWG
Dimensions	4.6" H x 2.9" W x .45" D

MHR/MHW MINI-HORNS

The **MHR** and **MHW** SpectrAlert® Advance mini-horns feature temporal or continuous tones at high and low volume settings. Their small footprint allows mounting to single-gang back boxes for applications where a small device is desired.



MHR.wmf, MHW.wmf



60535cov.wmf

MHR/MHW SpectrAlert Advance Mini-Horns	
Voltage	Regulated 12 DC or FWR (Full Wave Rectified) or Regulated 24 VDC or FWR
Operating Voltage	8 to 33 VDC (9 to 33 VDC with Sync-Circuit™ Module)
Sounder Current Draw	22 mA RMS max. at 8 to 17.5 Volts DC 17 mA RMS max. at 8 to 17.5 Volts FWR 29 mA RMS max. at 16 to 33 Volts DC 25 mA RMS max. at 16 to 33 Volts FWR
Temperature Range	32°F to 120°F (0°C to 49°C)
Humidity Range	10 to 93% non-condensing
Nominal Sounder Frequency	3 kHz
Wire Gauge	12 to 18 AWG
Dimensions	4.6"H x 2.9"W x 0.45"D

RA100Z/RA100ZA REMOTE ANNUNCIATORS

The **RA100Z** and **RA100ZA** remote annunciators are designed for both conventional and intelligent applications. Their red LED provides visual indication of an alarm condition.



RA100Z.wmf

RA100Z/RA100ZA Remote Annunciator	
Voltage Range	Conventional System: 3.1 to 32 VDC Intelligent System: 18 to 32 VDC
Maximum Alarm Current	10 mA
Dimensions	4.6"H x 2.8"W x 1.3"D

RTS151/RTS151KEY REMOTE TEST STATIONS

The **RTS151** and **RTS151KEY** remote test stations are automatic fire detector accessories designed to test duct smoke detectors from a convenient location. For 4-wire detectors, the **RTS151KEY** test station features a multi-colored LED that alternates between steady green and red. For 2-wire detectors, the LED illuminates red for alarm.



RTS151.wmf, RTS151KEY.wmf

RTS151 Remote Test Station	
Power Requirements	Alarm LED 2.8 to 32 VDC, 10 mA max. Total Current: 95 mA max.
Test Switch	10 VA @ 32 VDC
Reset Switch	10 VA @ 32 VDC
Alarm Response Time	40 seconds max.
Temperature Range	14°F to 140°F (-10°C to 60°C)
Relative Humidity	95% non-condensing
Wire Gauge	14 to 18 AWG
Dimensions	4.8"H x 2.9W x 1.4"D

RTS151KEY Remote Test Station with Key

Power Requirements	Power LED (Green): 14 to 35 VDC, 12 mA max. Alarm LED (RED): 2.8 to 32 VDC, 12 mA max.
Alarm Response Time	40 seconds max.
Temperature Range	14°F to 140°F (-10°C to 60°C)
Relative Humidity	95% non-condensing
Wire Gauge	14 to 18 AWG
Dimensions	4.6"H x 2.75W x 1.8"D

RTS2/RTS-AOS MULTI-SIGNALLING ACCESSORIES

The **RTS2** and **RTS2-AOS** multi-signaling accessories are designed to work with InnovairFlex 4-wire conventional duct smoke detectors. These accessories include a key switch that can be used to select one of two connected sensors to be tested, reset, or both by a push button switch. They also enable sensitivity measurements using the SENS-RDR sensitivity reader (sold separately). The **AOS** (Add-On Strobe) is an optional accessory included with the **RTS2-AOS** model.



RTS-AOS.wmf, AOS.wmf

RTS2 and RTS-AOS Multi-Signaling Accessory

Voltage	20 to 29 VDC
Power Requirements	Standby: 3.0 mA max. Trouble: 16.0 mA max. Alarm without Strobe: 30 mA max. Alarm with Strobe: 55 mA max.
Sounder	85 dBA at 10 ft.
Temperature Range	14°F to 140°F (-10°C to 60°C)
Relative Humidity	95% non-condensing
Wire Gauge	14 to 22 AWG
Dimensions	4.8"W x 5.3"H x 1.6"D

Product Line Information

APA151: Piezo Annunciator

MHR: Mini-Horn, Red

MHW: Mini-Horn, White

RA100Z/RA100ZA: Remote Annunciator

RTS151: Remote Test Station

RTS151KEY: Remote Test Station with Key

RTS2: Multi-signaling Accessory

AOS: Add-On Strobe

RTS2-AOS: Multi-Signaling Accessory

Temperature and Humidity Ranges

This system meets NFPA requirements for operation at 0 – 49°C/32 – 120°F and at a relative humidity 93% ± 2% RH (noncondensing) at 32°C ± 2°C (90°F ± 3°F). However, the useful life of the system's standby batteries and the electronic components may be adversely affected by extreme temperature ranges and humidity. Therefore, it is recommended that this system and its peripherals be installed in an environment with a normal room temperature of 15 – 27°C/60 – 80°F.

Agency Listings and Approvals

The listings and approvals below apply to the basic products. In some cases, certain modules may not be listed by certain approval agencies, or listing may be in process. Consult factory for latest listing status.

- **UL: S4011 (APA 151, MHR, MHW), S2522 (RTS2, RA100Z, RTS151, RTS151KEY, RTS2-AOS)**
- **FM Approved**
- **CSFM: 7135-1653:0212**

FlashScan®, **NOTIFIER®** and **System Sensor®** are registered trademarks of Honeywell International Inc.
©2012 by Honeywell International Inc. All rights reserved. Unauthorized use of this document is strictly prohibited.



This document is not intended to be used for installation purposes.
We try to keep our product information up-to-date and accurate.
We cannot cover all specific applications or anticipate all requirements.
All specifications are subject to change without notice.

For more information, contact Notifier. Phone: (203) 484-7161, FAX: (203) 484-7118.
www.notifier.com



Made in the U.S. A.



L-Series and L-Series with LED Indoor Selectable Horns, Strobes and Horn Strobes

System Sensor L-Series and L-Series with LED audible visible notification products are rich with features guaranteed to cut installation times and maximize profits with lower current draw and modern aesthetics.



Features

- LED technology provides lower current draw
- Digital Voltage Meter (DVM) diagnostic test points for Horn Strobes and Strobes
- Common aesthetics across the L-Series platform
- Standard and compact sizes
- Tamper-resistant construction
- Field-selectable candela settings on wall units: 15, 30, 75, 95, 110, 135, and 185
- Field-selectable candela settings on ceiling units: 15, 30, 75, 95, 115, 150, and 177
- Rotary switches for candela, tone and volume selections
- Mounting plate provides plug-in design for easier installation and shorting springs to check wiring continuity
- Electrically compatible with legacy SpectrAlert, SpectrAlert Advance and L-series devices
- Synchronization through use of UL approved power supplies that support System Sensor Sync protocol or System Sensor MDL3 Sync Module
- Horns, Strobes and Horn Strobes listed for wall or ceiling use

Agency Listings



The System Sensor L-Series and L-Series with LED platform

offers the most versatile and easy-to-use line of horns, strobes, and horn strobes in the industry with lower current draw and modern aesthetics. LED lighting technology offers significantly lower current draw compared to older Xenon bulbs across a full candela range. This improves design flexibility for notification appliance circuits (NACs) while also reducing power supply requirements allowing for simpler and lower cost installations.

Flexible design options meet virtually any application requirement: wall or ceiling mount, standard or compact sizes, red or white color choices, bezel kits for alternate markings and languages, and LED color lenses for distinctive visual signaling. In addition, installers can easily adapt devices using field selectable candela, tone and volume settings using rotary switches.

The L-Series and L-Series with LED line is developed to simplify installation. All devices feature plug-in designs with minimal intrusion into the back box, making installations fast and foolproof while virtually eliminating costly and time-consuming ground faults. The universal mounting plate includes an onboard shorting spring, so installers can test wiring continuity before the device is installed.

In addition, the System Sensor L-Series with LED notification appliances offer a new diagnostic test point feature that allows you to measure device voltage with a digital voltage meter (DVM) without removing the appliance from the wall or ceiling. The DVM test points are discreetly located on the face of the notification appliance which enable faster troubleshooting and end of line (EOL) voltage checks while greatly reducing the risk of misplacing or damaging appliances during troubleshooting.

L-Series and L-Series with LED Specifications

Physical/Electrical Specifications	
Standard Operating Temperature	32°F to 120°F (0°C to 49°C)
Humidity Range	10 to 93% non-condensing
Strobe Flash Rate	1 flash per second
Nominal Voltage, LED Strobes and Horn Strobes	Regulated 24 VDC
Nominal Voltage, Horns	Regulated 12 VDC or regulated 24 DC/FWR
Operating Voltage Range, LED Strobes and Horn Strobes	16 to 33 V (24 V nominal)
Operating Voltage Range, Horns	8 to 17.5 V (12 V nominal) or 16 to 33 V (24 V nominal)
Input Terminal Wire Gauge	12 to 18 AWG

UL/ULC Current Draw Data, Horn Tones, and Sound Output Data

UL/ULC Maximum Strobe Current Draw (mA)			
Candela Rating	16–33 Volts		
	Wall	CEILING	
Candela Range	15	18	18
	30	22	22
	75	70	70
	95	75	75
	110	85	—
	115	—	90
	135	105	—
	150	—	110
	177	—	115
	185	120	—

UL/ULC Maximum Horn Current Draw (mA RMS)				
Sound Pattern	dB	8–17.5 Volts		
		DC	DC	FWR
Temporal	High	39	44	54
Temporal	Low	28	32	54
Non-Temporal	High	43	47	54
Non-Temporal	Low	29	32	54
3.1 KHz Temporal	High	39	41	54
3.1 KHz Temporal	Low	29	32	54
3.1 KHz Non-Temporal	High	42	43	54
3.1 KHz Non-Temporal	Low	28	29	54
Coded	High	43	47	54
3.1 KHz Coded	High	42	43	54

UL/ULC Maximum Horn Strobe Current Draw (mA) and Sound Output (dBA)														
Switch Pos.	Sound Pattern	Volume Setting	Current Draw (mA RMS), Horn Strobe, Candela Range (15-185 cd)										Sound Output (dBA)	
			16-33 Volts											16-33V
			15cd	30cd	75cd	95cd	110cd WALL	115cd CEILING	135cd WALL	150cd CEILING	177cd CEILING	185cd WALL		
1	Temporal 3	High	35	38	87	92	94	120	189	189	190	190	87	
2	Temporal 3	Low	35	38	87	92	94	120	135	135	145	145	79	
3	Non-Temporal	High	50	52	87	92	94	120	127	127	135	135	87	
4	Non-Temporal	Low	35	38	87	92	94	120	125	125	130	130	79	
5	3.1KHz Temporal 3	High	35	38	87	89	91	115	155	155	165	165	86	
6	3.1KHz Temporal 3	Low	35	38	87	89	91	115	128	130	135	135	80	
7	3.1KHz Non-Temporal	High	40	42	87	89	91	115	125	125	135	135	86	
8	3.1KHz Non-Temporal	Low	35	38	87	89	91	115	120	120	130	130	80	

L-Series with LED Dimensions: Wall-Mounted Equipment

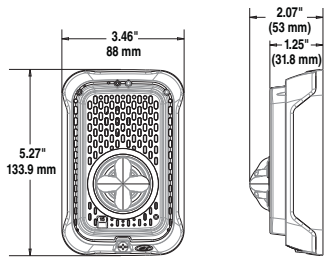

A0617-00

**Compact Strobe, Horn Strobe
for Wall**

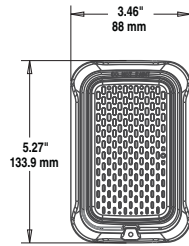

A0547-00

Compact Horn

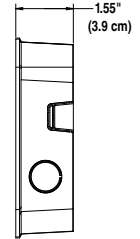
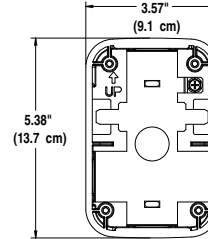
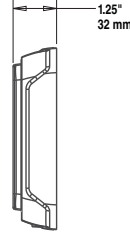

A0557-00

**Compact Surface Mount Back Box
for Walls (SBBGRL, SBBGWL)**

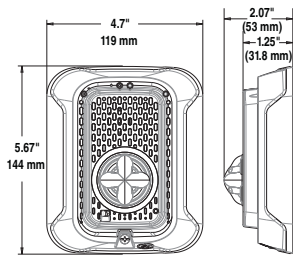

A0613-00

**Strobes, Horn Strobes
for Walls**

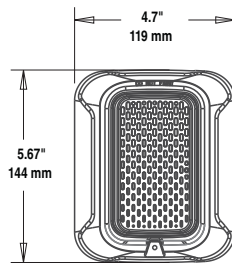

A0549-00

Horn

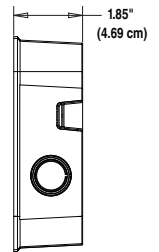
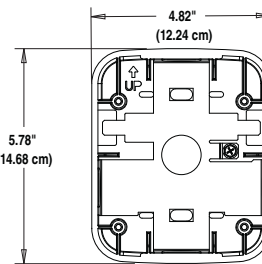
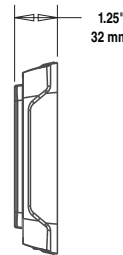

A0554-01

**Surface Mount Back Box
for Walls (SBBRL/SBBWL)**

L-Series with LED Dimensions: Ceiling-Mounted Equipment

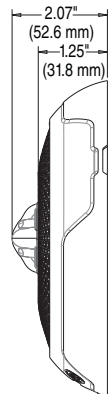
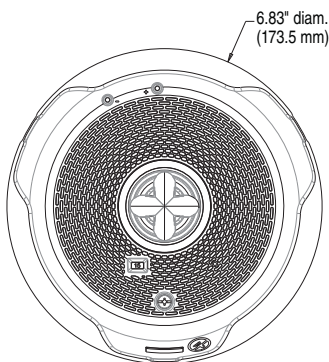

A0608-00

**Strobes and Horn Strobes
for Ceilings**

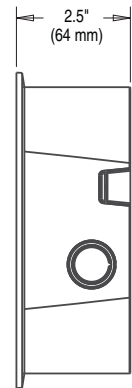
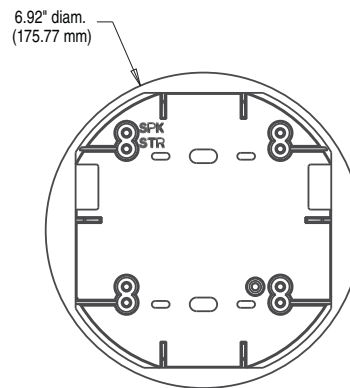

A0546-00

**Surface Mount Back Box
for Ceilings (SBBCRL, SBCWL)**

L-Series with LED: Ordering Information

Model	Description
L-Series with LED Horn Strobes	
P2RLED	2-Wire, Horn Strobe, Wall, Red
P2RLED-B	2-Wire, Horn Strobe, Wall, Red, Bilingual
P2WLED	2-Wire, Horn Strobe, Wall, White
P2WLED-B	2-Wire, Horn Strobe, Wall, White, Bilingual
P2GRLED	2-Wire, Compact Horn Strobe, Wall, Red
P2GRLED-B	2-Wire, Compact Horn Strobe, Wall, Red, Bilingual
P2GWLED	2-Wire, Compact Horn Strobe, Wall, White
P2GWLED-B	2-Wire, Compact Horn Strobe, Wall, White, Bilingual
P2RLED-P	2-Wire, Horn Strobe, Wall, Red, Plain
P2WLED-P	2-Wire, Horn Strobe, Wall, White, Plain
P2RLED-SP	2-Wire, Horn Strobe, Wall, Red, FUEGO
P2WLED-SP	2-Wire, Horn Strobe, Wall, White, FUEGO
PC2RLED	2-Wire, Horn Strobe, Ceiling, Red
PC2RLED-B	2-Wire, Horn Strobe, Ceiling, Red, Bilingual
PC2WLED	2-Wire, Horn Strobe, Ceiling, White
PC2WLED-B	2-Wire, Horn Strobe, Ceiling, White, Bilingual
L-Series with LED Strobes	
SRLED	Strobe, Wall, Red
SRLED-B	Strobe, Wall, Red, Bilingual
SWLED	Strobe, Wall, White
SWLED-B	Strobe, Wall, White, Bilingual
SGRLED	Strobe, Compact, Wall, Red
SGRLED-B	Strobe, Compact, Wall, Red, Bilingual
SGWLED	Strobe, Compact, Wall, White
SGWLED-B	Strobe, Compact, Wall, White, Bilingual
SRLED-P	Strobe, Wall, Red, Plain
SWLED-P	Strobe, Wall, White, Plain
SRLED-SP	Strobe, Wall, Red, FUEGO
SWLED-CLR-ALERT	Strobe, Wall, White, ALERT
SWLED-ALERT	Strobe, Wall, White, ALERT, Amber Lens
SCRLED	Strobe, Ceiling, Red
SCRLED-B	Strobe, Ceiling, Red, Bilingual
SCRLED-P	Strobe, Ceiling, White, Plain
SCWLED	Strobe, Ceiling, White
SCWLED-B	Strobe, Ceiling, White, Bilingual
SCWLED-P	Strobe, Ceiling, White, Plain
SCWLED-CLR-ALERT	Strobe, Ceiling, White, ALERT
L-Series Horns	
HRL*	Horn, Red
HRLA*	Horn, Red, Plain, ULC
HWL*	Horn, White
HWLA*	Horn, White, Plain, ULC
HGRLED*	Compact Horn, Red
HGRLED-A*	Compact Horn, Red, Plain, ULC
HGWLED*	Compact Horn, White
HGWLED-A*	Compact Horn, White, Plain, ULC

Model	Description
LED Lenses	
LENS-A3	Lens LED Amber Wall/Ceiling
LENS-B3	Lens LED Blue Wall/Ceiling
LENS-G3	Lens LED Green Wall/Ceiling
LENS-R3	Lens LED Red Wall/Ceiling
Accessories	
TR-2	Universal Wall Trim Ring Red
TR-2W	Universal Wall Trim Ring White
SBBRL	Wall Surface Mount Back Box, Red
SBBWL	Wall Surface Mount Back Box, White
SBBGRL	Compact Wall Surface Mount Back Box, Red
SBBGWL	Compact Wall Surface Mount Back Box, White
TRC-2	Universal Ceiling Trim Ring, Red
TRC-2W	Universal Ceiling Trim Ring, White
SBBCRL	Ceiling Surface Mount Back Box, Red
SBBCWL	Ceiling Surface Mount Back Box, White
Bezels†	
BZR	Wall Red Bezel Kit
BZW	Wall White Bezel Kit
BZGR	Compact Wall Red Bezel Kit
BZGW	Compact Wall White Bezel Kit
BZRC	Horn Strobe Ceiling Red Bezel Kit
BZWC	Horn Strobe Ceiling White Bezel Kit

Notes for L-Series With LED Horn Strobes and Strobes:

All -P models have a plain housing (no "FIRE" marking on cover).
 All -SP models have "FUEGO" marking on cover.
 All -ALERT models have "ALERT" marking on cover.
 All -B models have "FIRE/FEU" marking on cover for use in Canadian applications.
 Amber lenses are not for use in Canadian applications

Notes for L-Series Horns:

*Horn-only models are listed for wall or ceiling use.

Notes for Bezels:

†Each bezel pack ships in a package of 5.
 Add one of the following extensions for print/language options: -F (FIRE), -AL (ALERT), -EV (EVAC), -AG (AGENT), -P (Plain), -FR (FEU), -PG (FOGO), -SP (FUEGO), -SPE (FUEGO/FIRE).

3825 Ohio Avenue • St. Charles, IL 60174 USA
 Phone: 800-SENSOR2 • Fax: 630-377-6495
 www.systemsensor.com

3333 Unity Drive, Mississauga, ON L5L 3S6 Canada
 Phone: 800-SENSOR2 • Fax: 905-812-0771
 www.systemsensor.ca

System Sensor® is a registered trademark
 of Honeywell International, Inc.



©2023 System Sensor.
 Product specifications subject to change without notice. Visit systemsensor.com
 for current product information, including the latest version of this data sheet.
 AVDS916-01 • 10/03/2023



PAM-1 and PAM-2 Multi-Voltage Relay Modules

Section: Miscellaneous

GENERAL

Air Products & Controls, Inc. **PAM-1** and **PAM-2 Multi-Voltage Relay Modules** are encapsulated multi-voltage devices. The PAM-1 relay provides 10.0 Amp Form-C contacts and may be energized by one of three input voltages: 24 VAC, 24 VDC, or 115 VAC. The PAM-2 relay provides 7.0 Amp Form-C contacts and may be energized by one of two input voltages: 12 VDC or 24 VDC.

A red LED is provided on both models. When illuminated, it indicates the relay coil is energized.

Either model may be mounted by using the double-sided adhesive tape, the self-drilling screw, or by placing loosely in a backbox.

PAM-1 and PAM-2 Relay Modules are ideal for applications where remote relays are required for control or status feedback. They are suitable for use with HVAC, temperature control, fire alarm, security, energy management, and lighting control systems.

SPECIFICATIONS

Power requirements: *for PAM-1:* 0.015 Amps per position @ 24 VDC, 24 VAC, 115 VAC; *for PAM-2:* 0.015 Amps per position @ 12 VDC or 24 VDC.

Relay: UL-recognized SPDT.

Contact rating, PAM-1: 10.0 A @ 115 VAC; 7.0 A @ 28 VDC; 250 μ A @ 5 VDC.

Contact rating, PAM-2: 7.0 A @ 115 VAC; 7.0 A @ 28 VDC; 250 μ A @ 5 VDC.

Ambient temperature range: -58°F to +185°F (-50°C to +85°C).

Dimensions: 1.500" (38.100 mm) high x 1.000" (25.400 mm) wide x 0.875" (22.225 mm) deep, with 12" (304.8 mm) wire leads @ 18 AWG (0.75 mm²).

WIRING DIAGRAMS

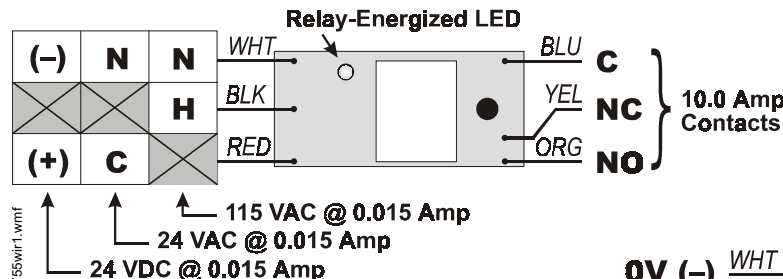

MEA
73-92-E
Vol. XXI



California
State Fire
Marshal
7300-1004:101



PRODUCT LINE INFORMATION

PAM-1 Single SPDT relay with LED, double-sided adhesive tape, mounting screw, 12" (304.8 mm) leads and six wire-nuts. **Power requirements:** 0.015 Amps per position @ 24 VDC, 24 VAC, 115 VAC. **Contact rating:** 10.0 A @ 115 VAC, 7.0 A @ 28 VDC, 250 μ A @ 5 VDC.

PAM-2 Single SPDT relay with LED, double-sided adhesive tape, mounting screw, 12" (304.8 mm) leads and six wire-nuts. **Power requirements:** 0.015 Amps per position @ 12 VDC or 24 VDC. **Contact rating:** 7.0 A @ 115 VAC; 7.0 A @ 28 VDC; 250 μ A @ 5 VDC.

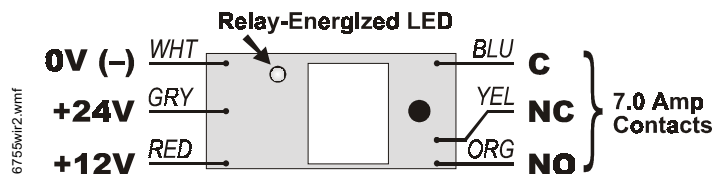

This document is not intended to be used for installation purposes. We try to keep our product information up-to-date and accurate. We cannot cover all specific applications or anticipate all requirements. All specifications are subject to change without notice. For more information, contact NOTIFIER. Phone: (203) 484-7161 FAX: (203) 484-7118

NOTIFIER 12 Clintonville Road, Northford, Connecticut 06472

ISO 9001
CERTIFIED
ENGINEERING & MANUFACTURING