

Notifier Early Warning Fire Alarm System

Submittal Data For:

Cape Fear Valley Health – Harnett

Core & Shell

225 Brightwater Drive

Lillington, NC 27546

NFS-320 Intelligent Addressable Fire Alarm Control Panel

General

The NFS-320 intelligent Fire Alarm Control Panel is part of the ONYX® Series of Fire Alarm Controls from NOTIFIER.

In stand-alone or network configurations, ONYX Series products meet virtually every application requirement.

The NFS-320's modular design makes system planning easier. The panel can be configured with just a few devices for small building applications, or networked with many devices to protect a large campus or a high-rise office block. Simply add additional peripheral equipment to suit the application. Wireless fire protection can be added with the SWIFT wireless gateway and devices.

For installations using NFS-320C, an optional ACM Series annunciator can be mounted in the same cabinet (up to 48 zones/points, order separately; see DN-60085).

NOTE: Unless called out with a version-specific "R", "C" or "E" at the end of the part number, "NFS-320" refers to models NFS-320, NFS-320R, NFS-320C, and NFS-320E.

Features

- Certified for seismic applications when used with the appropriate seismic mounting kit.
- Approved for Marine applications when used with listed compatible equipment. See DN-60688.
- One isolated intelligent Signaling Line Circuit (SLC) Class A, B, or X.
- Up to 159 detectors and 159 modules per SLC; 318 devices maximum.
 - Detectors can be any mix of ion, photo, thermal, or multi-sensor; wireless detectors are available for use with the FWSG.
 - Modules include addressable pull stations, normally open contact devices, two-wire smoke detectors, notification, or relay; wireless modules are available for use with the FWSG.
- Optional FWSG Wireless SWIFT Gateway supports wireless SLC devices.
- Standard 80-character display.
- Network options:
 - High-speed network for up to 200 nodes (NFS2-3030, NFS2-640, NFS-320(C), NFS-320SYS, NCD, NCA-2, DVC-EM, ONYXWorks, NFS-3030, NFS-640, and NCA).
 - Standard network for up to 103 nodes (NFS2-3030, NFS2-640, NFS-320(C), NFS-320SYS, NCD, NCA-2, DVC-EM, ONYXWorks, NCS, NFS-3030, NFS-640, NCA, AFP-200, AFP-300/400, AFP-1010, and AM2020). Up to 54 nodes when DVC-EM is used in network paging.
- 6.0 A power supply with four Class A/B built-in Notification Appliance Circuits (NAC). Selectable System Sensor, Wheelock, or Gentex strobe synchronization.
- Built-in Alarm, Trouble, Security, and Supervisory relays.
- VeriFire® Tools online or offline programming utility. Upload/Download, save, store, check, compare, and simulate panel databases. Upgrade panel firmware.
- Autoprogramming and Walk Test reports.
- Multiple central station communication options:
 - Standard UDACT
 - Internet
 - Internet/GSM
- 80-character remote annunciators (up to 32).
- EIA-485 annunciators, including custom graphics.



7112ph01.jpg

- Printer interface (80-column and 40-column printers).
- History file with 800-event capacity in nonvolatile memory, plus separate 200-event alarm-only file.
- Alarm Verification selection per point, with automatic counter.
- Presignal/Positive Alarm Sequence (PAS).
- Silence inhibit and Auto Silence timer options.
- NAC coding functions:
 - March time.
 - Temporal.
 - California two-stage coding.
 - Canadian two-stage.
 - Strobe synchronization.
- Field-programmable on panel or on PC with VeriFire® Tools program check, compare, simulate.
- Full QWERTY keypad.
- Battery charger supports 18 – 200 AH batteries.
- Non-alarm points for lower priority functions.
- Remote ACK/Signal Silence/System Reset/Drill via monitor modules.
- Automatic time control functions, with holiday exceptions.
- Extensive, built-in transient protection.
- Powerful Boolean logic equations.

SWIFT WIRELESS

- Self-healing mesh wireless protocol.
- Each SWIFT Gateway supports up to 50 devices: 1 wireless gateway and up to 49 SWIFT devices.
- Up to 4 wireless gateways can be installed with overlapping network coverage.

RELEASING FEATURES

- Ten independent hazards.
- Sophisticated cross-zone (three options).
- Delay timer and Discharge timers (adjustable).
- Abort (four options).
- Low-pressure CO₂ listed.

VOICE FEATURES

- Integrates with FirstCommand Series. See DN-60772.
- Telephone applications require NFC-FFT.

HIGH-EFFICIENCY OFFLINE SWITCHING

3.0 A POWER SUPPLY (6.0 A IN ALARM)

- 120 VAC (NFS-320/NFS-320C); 240 VAC (NFS-320E).
- Displays battery current/voltage on panel (with display).

FLASHSCAN® INTELLIGENT FEATURES

- Polls up to 318 devices in less than two seconds.
- Activates up to 159 outputs in less than five seconds.
- Multicolor LEDs blink device address during Walk Test.
- Fully digital, high-precision protocol (U.S. Patent 5,539,389).
- Manual sensitivity adjustment — up to nine levels.
- Pre-alarm ONYX intelligent sensing — up to nine levels.
- Day/Night automatic sensitivity adjustment.
- Sensitivity levels:
 - **Photo** – 0.5 to 2.35%/foot obscuration.
 - **High-Sensitivity Photoelectric (VIEW®)** – Open Air Protection (0.5% - 2.0%/ft. obscuration), Special Applications (0.02%-0.5%/ft. obscuration)
 - **Multi-Criteria Detector** – Open Air Protection (2.52-3.89%/ft. obscuration), Special Applications (1.13-2.52%/ft. obscuration)
- Drift compensation (U.S. Patent 5,764,142).
- Degraded mode: In the unlikely event that the NFS-320's primary microprocessor fails, FlashScan detectors revert to degraded operation and can activate the control panel's NAC circuits and alarm relay. Each of the four built-in panel circuits includes a Disable/Enable switch for this feature.
- Multi-detector algorithm involves nearby detectors in alarm decision (U.S. Patent 5,627,515).
- Automatic detector sensitivity testing (NFPA-72 compliant).

- Maintenance alert (two levels).
- Self-optimizing pre-alarm.

FSV-951 SERIES VIEW® (VERY INTELLIGENT EARLY WARNING)

HIGH-SENSITIVITY SMOKE DETECTOR

- Advanced ONYX intelligent sensing algorithms differentiate between smoke and non-smoke signals.
- Addressable operation pinpoints the fire location.
- Ivory models (-IV) support CLIP mode as well as FlashScan.
- ULC listed models available; "A" models are ULC Listed.
- -R is retrofit, backwards compatible for use with older panels.

FCO-951-IV ADVANCED MULTI-CRITERIA FIRE/CO DETECTOR

- Detects all four major elements of a fire (smoke, heat, CO, and flame).
- 135°F (57.2°C) fixed-temperature heat detector.
- Transmits an alarm signal due to heat.
- Separate signal for life-safety CO detection.
- Optional addressable sounder base for Temp-3 (fire) or Temp-4 (CO) tone.
- Automatic drift compensation of smoke sensor and CO cell.
- High nuisance-alarm immunity.
- ULC listed models available; -A models are ULC Listed.

FPTI-951(A) INTELLIGENT MULTI-CRITERIA DETECTOR

- Combined photoelectric, thermal, and infrared sensor
- UL 268 7th Edition and UL 521 Listed; Canadian models CAN/ULC S529 and CAN/ULC S530
- Microprocessor-based technology; combination photo, thermal, and infrared technology.

FPC-951(A) PHOTOELECTRIC/CO SENSOR

- Combined photoelectric and carbon monoxide sensor

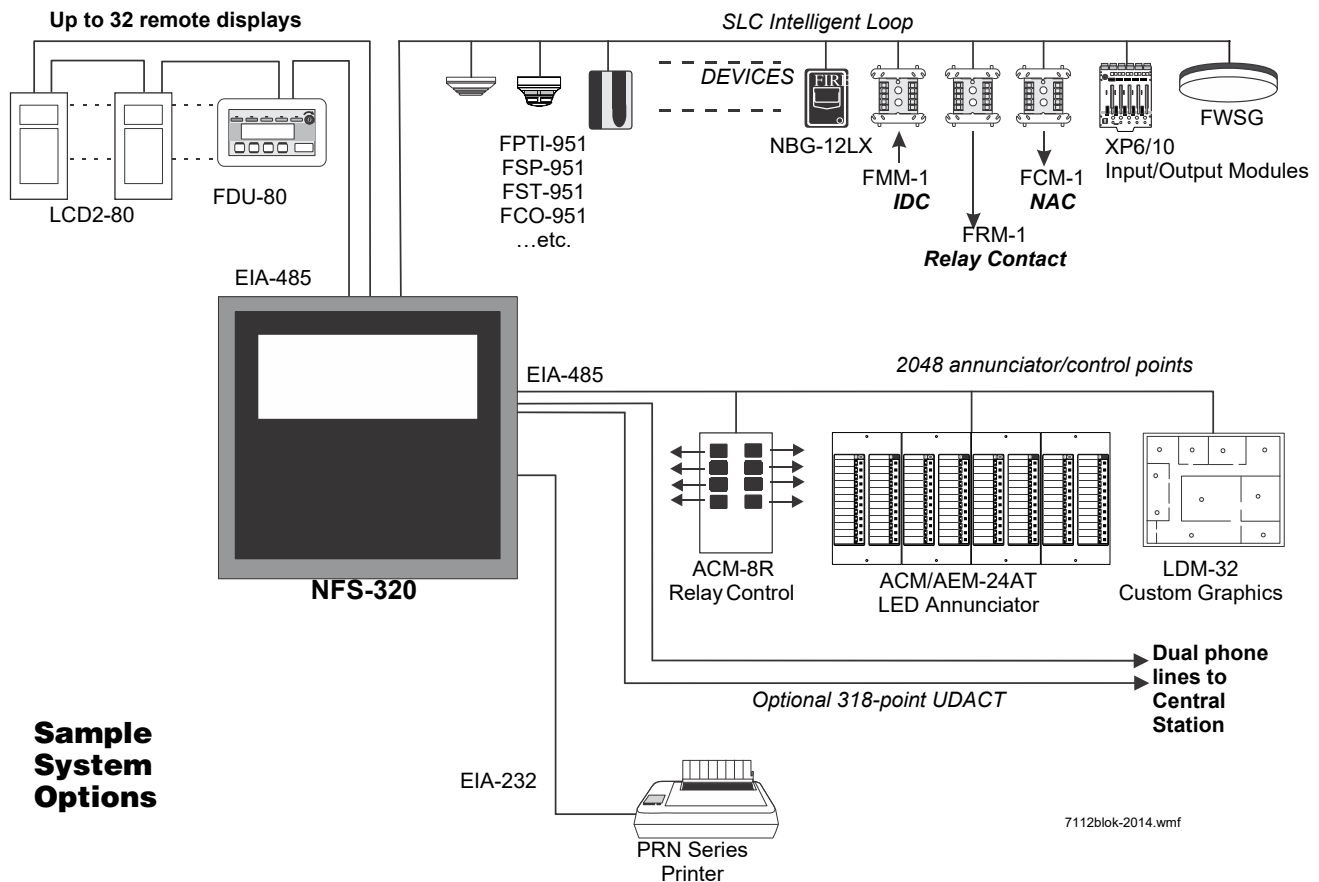

FSCO-95(A) INTELLIGENT CO SENSOR

- Carbon monoxide sensor

FS-OSI-RI(A) ADDRESSABLE INTELLIGENT SINGLE-ENDED BEAM SMOKE DETECTOR

- Intelligent addressable reflector-type linear optical beam smoke detector
- Fast, easy, and intuitive beam alignment indicated by directional LED arrows
- Long range coverage of 16-328 ft (5-100 m) is standard; no separate long-range kit required

INTELLIGENT VESDA DETECTORS

- Intelligent aspiration smoke detectors connect directly to the SLC loop of compatible ONYX® Series panels:
 - VEA-040-A00-NTF, VEA-040-A10-NTF
 - VEP-A00-P-NTF, VEP-A10-P-NTF, VEP-A00-1P-NTF
 - VEU-A00-NTF, VEU-A10-NTF
- Models offer LED display, LCD display, or both
- Coverage options for spaces up to 69,965 square feet

FlashScan, Exclusive World-Leading Detector Protocol

At the heart of the NFS-320 is a set of detection devices and device protocol — FlashScan (U.S. Patent 5,539,389). FlashScan is an all-digital protocol that gives superior precision and high noise immunity.

In addition to providing quick identification of an active input device, this protocol can also activate many output devices in a fraction of the time required by competitive protocols. This high speed also allows the NFS-320 to have the largest device per loop capacity in the industry — 318 points — yet every input and output device is sampled in less than two seconds. The microprocessor-based FlashScan detectors have bicolor LEDs that can be coded to provide diagnostic information, such as device address during Walk Test.

ONYX Intelligent Sensing

Intelligent sensing is a set of software algorithms that provides the NFS-320 with industry-leading smoke detection capability. These complex algorithms require many calculations on each reading of each detector, and are made possible by the high-speed microcomputer used by the NFS-320.

Drift Compensation and Smoothing: Drift compensation allows the detector to retain its original ability to detect actual smoke, and resist false alarms, even as dirt accumulates. It reduces maintenance requirements by allowing the system to automatically perform the periodic sensitivity measurements required by NFPA 72. Smoothing filters are also provided by software to remove transient noise signals, such as those caused by electrical interference.

Maintenance Warnings: When the drift compensation performed for a detector reaches a certain level, the performance of the detector may be compromised, and special warnings are given. There are three warning levels: (1) Low Chamber value; (2) Maintenance Alert, indicative of dust accumulation that is near but below the allowed limit; (3) Maintenance Urgent, indicative of dust accumulation above the allowed limit.

Sensitivity Adjust: Nine sensitivity levels are provided for alarm detection. These levels can be set manually, or can change automatically between day and night. Nine levels of pre-alarm sensitivity can also be selected, based on predetermined levels of alarm. Pre-alarm operation can be latching or self-restoring, and can be used to activate special control functions.

Self-Optimizing Pre-Alarm: Each detector may be set for “Self-Optimizing” pre-alarm. In this special mode, the detector “learns” its normal environment, measuring the peak analog readings over a

long period of time, and setting the pre-alarm level just above these normal peaks.

Cooperating Multi-Detector Sensing: A patented feature of ONYX intelligent sensing is the ability of a smoke sensor to consider readings from nearby sensors in making alarm or pre-alarm decisions. Without statistical sacrifice in the ability to resist false alarms, it allows a sensor to increase its sensitivity to actual smoke by a factor of almost two to one.

Field Programming Options

Autoprogram is a timesaving feature. The FACP “learns” what devices are physically connected and automatically loads them in the program with default values for all parameters. Requiring less than one minute to run, this routine allows the user to have almost immediate fire protection in a new installation, even if only a portion of the detectors are installed.

Keypad Program Edit (with KDM-R2) The NFS-320, like all NOTIFIER intelligent panels, has the exclusive feature of program creation and editing capability from the front panel keypad, while continuing to provide fire protection. The architecture of the NFS-320 software is such that each point entry carries its own program, including control-by-event links to other points. This allows the program to be entered with independent per-point segments, while the NFS-320 simultaneously monitors other (already installed) points for alarm conditions.

VeriFire® Tools is an offline programming and test utility that can greatly reduce installation programming time, and increase confidence in the site-specific software. It is Windows®-based and provides technologically advanced capabilities to aid the installer. The installer may create the entire program for the NFS-320 in the comfort of the office, test it, store a backup file, then bring it to the site and download from a laptop into the panel.

Placement of Equipment in Chassis and Cabinet

The following guidelines outline the NFS-320’s flexible system design.

Wiring: When designing the cabinet layout, consider separation of power-limited and non-power-limited wiring as discussed in the *NFS-320 Installation Manual*.

It is critical that all mounting holes of the NFS-320 are secured with a screw or standoff to ensure continuity of Earth Ground.

Networking: If networking two or more control panels, each unit requires a Network Communication Module or High-Speed Network Communication Module (HS-NCM can support two nodes; see “Networking Options” on page 4). These modules can be installed in any option board position (see manual), and additional option boards can be mounted in front of them.

KDM-R2 Controls and Indicators

Program Keypad: QWERTY type (keyboard layout).

12 LED Indicators: Power; Fire Alarm; Pre-Alarm; Security; Supervisory; System Trouble; Signals Silenced; Points Disabled; Control Active; Abort; Pre-Discharge; Discharge.

Keypad Switch Controls: Acknowledge/Scroll Display; Signal Silence; Drill; System Reset; Lamp Test.

LCD Display: 80 characters (2 x 40) with long-life LED backlight.

Product Line Information

- “Configuration Guidelines” on page 4
- “Main System Components” on page 4
- “Networking Options” on page 4
- “Auxiliary Power Supplies and Batteries” on page 4
- “Audio Options” on page 4
- “Compatible Devices, EIA-232 Ports” on page 4
- “Compatible Devices, EIA-485 Ports” on page 4
- “Compatible Intelligent Devices” on page 5
- “Enclosures, Chassis, and Dress Plates” on page 6
- “Other Options” on page 6

CONFIGURATION GUIDELINES

The NFS-320 system ships assembled; description and some options follow. See “Enclosures, Chassis, and Dress Plates” on page 6 for information about mounting peripherals.

Stand-alone and network systems require a main display. On stand-alone systems, the panel's keypad provides the required display. On network systems (two or more networked fire panel nodes), at least one NCD, NCA-2, NCS, or ONYXWorks annunciation device is required. (For NCA-2, see DN-7047. For NCD, see DN-60974.)

MAIN SYSTEM COMPONENTS

NFS-320: The standard, factory-assembled NFS-320 system includes the following components: one control panel mounted on chassis (120 V operation — ships with grounding cable, battery interconnect cables, and document kit); includes integral power supply mounted to the main circuit board; one primary display KDM-R2 keypad/display; and one cabinet for surface or semi-flush mounting. Purchase batteries separately. One or two option boards may be mounted inside the NFS-320 cabinet; additional option boards can be used in remote cabinets. (Non-English versions also available. NFS-320-SP, NFS-320-PO.)

NFS-320R: Same as NFS-320, but in red enclosure.

NFS-320C: Based on NFS-320 above. NFS-320C supports installation of an optional ACM-series annunciator in the same cabinet. UL and ULC-listed. (Non-English version also available: NFS-320C-FR.) For NFS-320C, see DN-60085.

NFS-320CR: Same as NFS-320C but in a red enclosure. For NFS-320C, see DN-60085.

NFS-320E: Same as NFS-320, but with 240 V operation. (Non-English versions also available. NFS-320E-SP, NFS-320E-PO.)

TR-320: Trim ring for the NFS-320 cabinet.

NETWORKING OPTIONS

NCM-W, NCM-F: Standard Network Communications Modules. Wire and multi-mode fiber versions available. See DN-6861.

HS-NCM-W(-2), HS-NCM-MF, HS-NCM-SF, HS-NCM-WMF(-2), HS-NCM-WSF(-2), HS-NCM-MFSF: High-speed Network Communications Modules. Wire, single-mode fiber, multi-mode fiber, and media conversion models are available. See DN-60454.

RPT-W, RPT-F, RPT-WF: Standard-network repeater board with wire connection (RPT-W), multi-mode fiber connection (RPT-F), or allowing a change in media type between wire and fiber (RPT-WF). Not used with high-speed networks. See DN-6971.

ONYXWorks: UL-listed graphics PC workstation, software, and computer hardware. See DN-7048 for specific part numbers.

NFN-GW-EM-3: NFN Gateway, embedded. See DN-60499.

NWS-3: NOTI•FIRE•NET™ Web Server. See DN-6928.

CAP-GW: Common Alerting Protocol Gateway. See DN-60756.

VESDA-HLI-GW: VESDAnet high-level interface gateway. See DN-60753.

LED SIGN-GW: UL-listed sign gateway. Interfaces with classic and high-speed NOTI•FIRE•NET networks through the NFN Gateway. See DN-60679.

OAX2-24V: UL-listed LED sign, used with LED SIGN-GW. See DN-60679.

AUXILIARY POWER SUPPLIES AND BATTERIES

ACPS-610: 6.0 A or 10.0 A addressable charging power supply. See DN-60244.

APS2-6R: Auxiliary Power Supply. Provides up to 6.0 amperes of power for peripheral devices. Includes battery input and transfer relay, and overcurrent protection. Mounts on two of four positions on a CHS-4L or CHS-4 chassis. See DN-5952.

FCPS-24S6/S8: Remote 6 A and 8 A power supplies with battery charger. See DN-6927.

BAT Series: Batteries. NFS-320 uses two 12 volt, 18 to 200 AH batteries. See DN-6933.

AUDIO OPTIONS

NFC-50/100: 25 watt, 25 VRMS, emergency Voice Evacuation Control Panel (VECP) with integral commercial microphone, digital message generator, and Class A or Class B speaker circuits. See DN-60772.

COMPATIBLE DEVICES, EIA-232 PORTS

PRN-7: 80-column printer. See DN-60897.

VS4095/5: Printer, 40-column, 24 V. Mounted in external backbox. See DN-3260.

DPI-232: Direct Panel Interface, specialized modem for extending serial data links to remotely located FACPs and/or peripherals; mount on NFS-320 chassis. See DN-6870.

COMPATIBLE DEVICES, EIA-485 PORTS

ACM-24AT: ONYX Series ACS annunciator — up to 96 points of annunciation with Alarm or Active LED, Trouble LED, and switch per circuit. Active/Alarm LEDs can be programmed (by powered-up switch selection) by point to be red, green, or yellow; the Trouble LED is always yellow. See DN-6862.

AEM-24AT: Same LED and switch capabilities as ACM-24AT, expands the ACM-24AT to 48, 72, or 96 points. See DN-6862.

ACM-48A: ONYX Series ACS annunciator — up to 96 points of annunciation with Alarm or Active LED per circuit. Active/Alarm LEDs can be programmed (by powered-up switch selection) in groups of 24 to be red, green, or yellow. Expandable to 96 points with one AEM-48A. See DN-6862.

AEM-48A: Same LED capabilities as ACM-48A, expands the ACM-48A to 96 points. See DN-6862.

ACM-8R: Remote Relay Module with eight Form-C contacts. Can be located up to 6,000 ft. (1828.8 m) from panel on four wires. See DN-3558.

FDU-80: Terminal mode. 80-character, backlit LCD display. Mounts up to 6,000 ft. (1828.8 m) from panel. Up to 32 per FACP. See DN-6820.

LCD2-80: Terminal and ACS mode. 80-character, backlit LCD display. Mounts up to 6,000 ft. (1828.8 m) from panel. Up to 32 per FACP. See DN-60548.

LDM: Lamp Driver Modules LDM-32, LDM-E32, and LDM-R32; remote custom driver modules. See DN-0551.

SCS: Smoke control stations SCS-8, SCE-8, with lamp drivers SCS-8L, SCE-8L; eight (expandable to 16) circuits (HVAC only). See DN-4818.

TM-4: Transmitter Module. Includes three reverse-polarity circuits and one municipal box circuit; mount on NFS-320 chassis or remotely. See DN-6860.

UDACT-2: Universal Digital Alarm Communicator Transmitter, 636 channel. See DN-60686.

UZC-256: Programmable Universal Zone Coder provides positive non-interfering successive zone coding. Microprocessor-controlled, field-programmable from IBM®-compatible PCs (requires optional programming kit). Mounts in **BB-UZC**. See DN-3404.

COMPATIBLE INTELLIGENT DEVICES

NOTE: “A” suffix indicates ULC-Listed model:

FWSG Wireless SWIFT Gateway: Addressable gateway supports wireless SLC devices. Not appropriate for ULC applications. See DN-60820.

FCO-951-IV FlashScan, Addressable intelligent multi-criteria smoke sensors, photo, carbon monoxide, fixed temperature heat detector and infra-red (IR). ULC: FCO-951A-IV

FPC-951. FlashScan, Combined photoelectric and carbon monoxide sensor. ULC: FPC-951A.

FSCO-951. FlashScan, Addressable carbon monoxide sensor. ULC: FSCO-951A.

FPTI-951, FPTI-951-IV: Addressable intelligent multi-criteria photoelectric, thermal and IR sensors. ULC: FPTI-951A, FPTI-951A-IV.

FS-OSI-RIAddressable intelligent single-ended beam smoke detector. ULC: FS-OSI-RIA.

FSP-951: White, low-profile intelligent photoelectric sensor, FlashScan only. ULC: FSP-951A.

FSP-951-IV: Ivory, low-profile intelligent photoelectric sensor. ULC: FSP-951A-IV

FSP-951T: White, same as FSP-951 but includes a built-in 135°F (57°C) fixed-temperature thermal device. FlashScan only. ULC: FSP-951TA.

FSP-951T-IV: Ivory, same as FSP-951T but includes a built-in 135°F (57°C) fixed-temperature thermal device. ULC: FSP-951TA-IV.

FSP-951R: White, low-profile intelligent photoelectric sensor, remote test capable. For use with DNR/DNRW. FlashScan only. ULC: FSP-951RA

FSP-951R-IV: Ivory, low-profile intelligent photoelectric sensor, remote test capable. FlashScan only. ULC: FSP-951RA-IV, for use with DNRA.

FST-951: White, low-profile intelligent 135°F fixed thermal sensor, FlashScan only. Must be mounted to one of the bases listed below. ULC: FST-951A. See DN-60975.

FST-951-IV: Ivory, low-profile intelligent 135°F fixed thermal sensor, FlashScan and CLIP. Must be mounted to one of the bases listed below. ULC: FST-951A-IV.

FST-951R: White, low-profile intelligent rate-of-rise thermal sensor, FlashScan only. Must be mounted to one of the bases listed below. ULC: FST-951A

FSP-951R-IV: Ivory, low-profile intelligent photoelectric sensor, remote test capable. FlashScan only. ULC: FSP-951RA-IV, for use with DNRA.

FST-951H: White, low-profile intelligent 190°F fixed thermal sensor, FlashScan only. Must be mounted to one of the bases listed below. ULC: FST-951HA.

FST-951H-IV: Ivory, low-profile intelligent 190°F thermal sensor, FlashScan and CLIP. Must be mounted to one of the bases listed below. ULC: FST-951HA-IV.

FSV-951, FSV-951R:White, intelligent high-sensitivity photoelectric smoke detector. ULC: FSV-951A, FSV-951RA

FSV-951-IV, FSV-951R-IV:Ivory, intelligent high-sensitivity photoelectric smoke detector. ULC: FSV-951A-IV, FSV-951RA-IV.

VEP-A00-P-NTF: Intelligent aspiration smoke detector with LED display, 4 pipes, covers up to 21,520 square feet. See DN-61029. UL/ULC Listed.

VEP-A10-P-NTF: Intelligent aspiration smoke detector with LED and LCD display, 4 pipes, covers up to 21,520 square feet. See DN-61029. UL/ULC Listed.

VEP-A00-1P-NTF: Intelligent aspiration smoke detector with LED display, single pipe, covers up to 10,760 square feet. See DN-61029. UL/ULC Listed.

VEU-A00-NTF: Intelligent aspiration smoke detector with LED display, 4 pipes, covers up to 69,965 square feet. See DN-61034. UL/ULC Listed.

VEU-A10-NTF: Intelligent aspiration smoke detector with LED and LCD display, 4 pipes, covers up to 69,965 square feet. See DN-61034. UL/ULC Listed.

VEA-040-A00-NTF: Intelligent aspiration with LED display, 40 point-addressable detection points. Covers 36,000 square feet. See DN-61036. UL/ULC Listed.

VEA-040-A10-NTF: Intelligent aspiration with LED and LCD display, 40 point-addressable detection points. Covers 36,000 square feet. See DN-61036. UL/ULC Listed.

DNR: InnovairFlex low-flow non-relay duct-detector housing. ULC: DNRA. (Order FSP-951R(A) separately.) See DN-60429.

DNRW: Same as above with NEMA-4 rating, watertight. See DN-60429.

B224RB-WH: White, low-profile relay base. See DN-60054. ULC: B224RBA-WH.

B224RB-IV: Ivory, plug-in System Sensor relay base. ULC: B224RBA-IV.

B224BI-WH: White, isolator base for low-profile detectors. See DN-60054. ULC: B224BIA-WH.

B224BI-IV: Ivory isolator detector base. ULC: B224BIA-IV.

B300-6: White, standard flanged low-profile mounting base. (For 10-pack order B300-6-BP.) ULC: B300A-6.

B300-6-IV: Ivory, standard flanged low-profile mounting base. ULC: B300A-6-IV.

B501-WHITE: European-style, 4" (10.16 cm) base. See DN-60054. (For 10-pack order B501-WHITE-BP.) UL/ULC listed.

B501-BL: Black, 4" standard European flangeless mounting base. UL/ULC listed.

B501-IV: Ivory color, 4" standard European flangeless mounting base. UL/ULC listed.

B200S-WH: White, intelligent programmable sounder base, capable of producing a variety of tone patterns including ANSI Temporal 3. Compatible with synchronization protocol. See DN-60054. ULC: B200SA-WH.

B200S-IV: Ivory intelligent, programmable sounder base. ULC: B200SA-IV.

B200SCOA-WH: White intelligent, programmable sounder base in English/French (required in Canada for ULC applications with CO detectors. Based on B200SA. ULC listed.

B200SCOA-IV: Ivory intelligent, programmable sounder base in English/French (required in Canada for ULC applications with CO detectors. Based on B200SA. ULC listed.

B200S-LF-WH: White, low-frequency version of B200S. See DN-60054.

B200S-LF-IV: Ivory, low-frequency version of B200S.

B200SR-WH: White intelligent programmable sounder base, Temporal 3 or Continuous tone. For retrofit installations replacing B501BH series bases. See DN-60054. ULC: B200SRA-WH.

B200SR-IV: Ivory intelligent programmable sounder base, Temporal 3 or Continuous tone. For retrofit installations replacing B501BH series bases. ULC: B200SRA-IV.

B200SR-LF-WH: White, low-frequency version of B200SR. See DN-60054.

B200SR-LF-IV: Ivory, low-frequency version of B200SR.

FMM-1: FlashScan monitor module. *See DN-6720.*

FDM-1(A): FlashScan dual monitor module. *See DN-6720.*

FZM-1(A): FlashScan two-wire detector monitor module. *See DN-6720.*

FMM-101(A): FlashScan miniature monitor module. *See DN-6720.*

FCM-1(A): FlashScan control module. *See DN-6724.*

FCM-1-REL(A): FlashScan releasing control module. *See DN-60390.*

FRM-1(A): FlashScan relay module. *See DN-6724.*

FDRM-1(A): FlashScan dual monitor/dual relay module. *See DN-60709.*

NBG-12LX: Manual pull station, addressable. *See DN-6726.*

N-MPS series: Manual pull stations, addressable and conventional. For use in Canada only. *See DN-5497 and DN-60629.* **ISO-X(A):** Isolator module. *See DN-2243.*

ISO-6(A): Six fault isolator module. *See DN-60844.*

XP6-C(A): FlashScan six-circuit supervised control module. *See DN-6924.*

XP6-MA(A): FlashScan six-zone interface module; connects intelligent alarm system to two-wire conventional detection zone. *See DN-6925.*

XP6-R(A): FlashScan six-relay (Form-C) control module. *See DN-6926.*

XP10-M(A): FlashScan ten-input monitor module. *See DN-6923.*

ENCLOSURES, CHASSIS, AND DRESS PLATES

CAB-BM Marine System: Protects equipment in shipboard and waterfront applications. Also order **BB-MB** for systems using 100 AH batteries. For a full list of required and optional equipment, see *DN-60688.*

NFS-LBB: Battery Box (required for batteries larger than 26 AH).

NFS-LBBR: Same as above, but red.

SEISKIT-320/B26: Seismic mounting kit. Required for seismic-certified applications with NFS-320 and BB-26. Includes battery bracket for two 26 AH batteries.

SEISKIT-BB25: Seismic mounting kit for the BB-25. Includes battery bracket for two 26 AH batteries.

SEISKIT-LBB: Seismic kit for the NFS-LBB. Includes battery bracket for two 55 AH batteries.

Backboxes

NOTE: "C" suffix indicates ULC-Listed mode.

ABF-1B Annunciator Flush Box.

ABF-1DB(C) Annunciator Flush Box with Door.

ABF-2B Annunciator Flush Box

ABF-2DB(C) Annunciator Flush Box with Door

ABF-4B Annunciator Flush Box

ABS-1TB(C) Annunciator Surface Box

ABS-1B(C) Annunciator Surface Box

ABS-2B Annunciator Surface Box

ABS-2D(C) Annunciator Surface Box

ABS-4D(C) Annunciator Surface Box

BB-UZC: Backbox for housing the UZC-256. Required for NFS-320 applications. Black. For red, order BB-UZC-R.

OTHER OPTIONS

411: Slave Digital Alarm Communicator. *See DN-6619.*

411UDAC: Digital Alarm Communicator. *See DN-6746.*

IPDACT-2/2UD, IPDACT Internet Monitoring Module: Connects to primary and secondary DACT telephone output ports for internet communications over customer-provided Ethernet connection. Requires compatible Teldat VisorALARM Central Station Receiver. Can use DHCP or static IP. *See DN-60408.*

IPSPLT: Y-adapter option allow connection of both panel dialer outputs to one IPDACT-2/2UD cable input.

IPENC: External enclosure for IPDACT, includes IPBRKT mounting bracket; Red. For Black order **IPENC-B**.

HWF2V-COM: LTE Digital Cellular Fire Alarm Communicator and Internet Panel, Verizon LTE / IP. Provides selectable configurable paths: cellular only, IP only, or IP primary with cellular backup. Connects to the primary and secondary ports of a DACT. *See DH-62010.* (For Canadian applications order IPGSM-4GC. *See DH-60771.*)

HWF2A-COM: LTE Digital Cellular Fire Alarm Communicator and Internet Panel, AT&T LTE / IP. Provides selectable configurable paths: cellular only, IP only, or IP primary with cellular backup. Connects to the primary and secondary ports of a DACT. (For Canadian applications order IPGSM-4GC. *See DH-60771.*)

NFS-320-RB: Replacement board with central processing unit (CPU). *NOTE: Keypad must be removed before shipping old unit out for repair.*

- NFS-320-RBE: Replacement CPU, Export.
- NFS-320-RB-PO: Replacement CPU, Portuguese.
- NFS-320-RB-POE: Replacement CPU, Export, Portuguese.
- NFS-320-RB-FR: Replacement CPU, Canadian French.
- NFS-320-RB-SP: Replacement CPU, Spanish.
- NFS-320-RB-SPE: Replacement CPU, Export, Spanish.

NOTE: For other options including compatibility with retrofit equipment, refer to the panel's installation manual, the SLC manual, and the Device Compatibility Document.

SPECIFICATIONS

SYSTEM CAPACITY

- Intelligent Signaling Line Circuits 1
- Intelligent detectors 159
- Addressable monitor/control modules 159
- Programmable internal hardware and output circuits 4
- Programmable software zones 99
- Special programming zones 14
- LCD annunciators per NFS-320/-320E 32
- ACS annunciators
per NFS-320/-320E 32 addresses x 64 points

ELECTRICAL SPECIFICATIONS

- Primary input power:
 - NFS-320: 120 VAC, 50/60 Hz, 5.0 A.
 - NFS-320E: 220/240 VAC, 50/60 Hz, 2.5 A.
- Current draw (standby/alarm):
 - NFS-320(E) board: 0.250 A. Add 0.035 A for each NAC in use.
 - KDM-R2 (Backlight on): 0.100 A.
- Total output 24 V power: 6.0 A in alarm.

NOTE: The power supply has a total of 6.0 A of available power. This is shared by all internal circuits. See Installation Manual for a complete current draw calculation sheet.

- Standard notification circuits (4): 1.5 A each.
- Resettable regulated 24V power: 1.25 A.
- Two non-resettable regulated 24V power outputs:
 - 1.25 A.
 - 0.50 A.
- Non-resettable 5V power: 0.15 A.
- Battery charger range: 18 AH – 200 AH. Use separate cabinet for batteries over 26 AH.
- Float rate: 27.6 V.

CABINET SPECIFICATIONS

NFS-320 cabinet dimensions:

- Backbox: 18.12 in. (46.025 cm) width; 18.12 in. (46.025 cm) height; 5.81 in. (14.76 cm) depth.
- Door: 18.187 in. (46.195 cm) width; 18.40 in. (46.736 cm) height; 0.75 in. (1.905 cm) depth.
- Trim ring: Molding width is 0.905 in. (2.299 cm).
- Shipping weight (without batteries): 36.15 lb. (16.4 kg).

TEMPERATURE AND HUMIDITY RANGES

This system meets NFPA requirements for operation at 0 – 49°C/32 – 120°F and at a relative humidity 93% ± 2% RH (noncondensing) at 32°C ± 2°C (90°F ± 3°F). However, the useful life of the system's standby batteries and the electronic components may be adversely affected by extreme temperature ranges and humidity. Therefore, it is recommended that this system and its peripherals be installed in an environment with a normal room temperature of 15 – 27°C/60 – 80°F.

AGENCY LISTINGS AND APPROVALS

The listings and approvals below apply to the basic NFS-320 control panel. In some cases, certain modules may not be listed by certain approval agencies, or listing may be in process. Consult factory for latest listing status.

- **UL/ULC Listed:** S635.
- **FM Approved.**
- **CSFM:** 7165-0028:0243.
- **MEA:** 128-07-E.
- **Fire Dept. of New York:** COA# 6212.
- **City of Chicago.**
- **ULC Listed:** S527-11

NOTE: For additional information on UL- and ULC-listed model NFS-320C, see DN-60085. For information on NFS-320SYS, see DN-60637.

Marine Applications: Marine approved systems must be configured using components itemized in this document. (See Main System Components, in "Product Line Information.") Specific connections and requirements for those components are described in the installation document, PN 54756. When these requirements are followed, systems are approved by the following agencies:

- **US Coast Guard** 161.002/50/0, 161.002/55/0 (Standard 46 CFR and 161.002).
- **Lloyd's Register** 11/600013 (ENV 3 category).
- **American Bureau of Shipping (ABS)** Type Approval.

NOTE: For information on marine applications, see DN-60688.

STANDARDS

The NFS-320 complies with the following UL Standards and NFPA 72, International Building Code (IBC), and California Building Code (CBC) Fire Alarm Systems requirements:

- **UL 864** (Fire).
- **UL 1076** (Burglary).
- **UL 2572** (Mass Notification Systems). (NFS-320 version 20 or higher).
- **ULC-S527-11** Standard for the Installation of Fire Alarm Systems.
- **LOCAL** (Automatic, Manual, Waterflow and Sprinkler Supervisory).
- **AUXILIARY** (Automatic, Manual and Waterflow) (requires TM-4).
- **REMOTE STATION** (Automatic, Manual, Waterflow and Sprinkler Supervisory) (requires TM-4).
- **PROPRIETARY** (Automatic, Manual, Waterflow and Sprinkler Supervisory). *Not applicable for FM.*
- **CENTRAL STATION** (Automatic, Manual, Waterflow and Sprinkler Supervisory) (requires DACT).
- **EMERGENCY VOICE/ALARM.**
- **OT, PSDN** (Other Technologies, Packet-switched Data Network).
- **IBC 2012, IBC 2009, IBC 2006, IBC 2003, IBC 2000** (Seismic).
- **CBC 2007** (Seismic).



This document is not intended to be used for installation purposes.
We try to keep our product information up-to-date and accurate.
We cannot cover all specific applications or anticipate all requirements.
All specifications are subject to change without notice.

NOTIFIER

12 Clintonville Road
Northford, CT 06472
203.484.7161
www.notifier.com

NOTIFIRE[®]NET[™], ONYXWorks[™], and SWIFT[™] are all trademarks of and FlashScan[®], NOTIFIER[®], ONYX[®], VeriFire[®] Tools, and VIEW[®] are all registered trademarks of Honeywell International Inc.
©2019 by Honeywell International Inc. All rights reserved. Unauthorized use of this document is strictly prohibited.

Country of Origin: USA



PS SERIES

6 Amp and 10 Amp, 24 Volt Power Supplies

The PS Series are independently configurable power supplies, allowing you to pair any input with any output, and feature LED diagnostics for troubleshooting.

The PS Series is a remote power supply line from Honeywell Power Products and is a direct replacement for the HPF-24S6/8. The HPF-PS6 is a 6 amp and the HPF-PS10 is a 10 amp, remote power supply with battery charger that may be connected to any 12 or 24 volt fire alarm control panel (FACP) or used as a standalone power supply. The PS Series provides 24 VDC power for NACs (notification appliance circuits) configured as either Class B or Class A (requires the ZNAC-PS option card) with multiple sync protocol options. The PS Series also provides auxiliary power, constant or resettable, suited for detectors, annunciators, door holders, and other fire alarm system peripherals. The PS Series cabinet can hold two 7 AH or 18 AH batteries and can charge up to 33 AH batteries in a separate cabinet. The HPF-PS6E and HPF-PS10E are models rated for 240V operation.

FEATURES AND BENEFITS

- Up to five (6 amp model) or seven (10 amp model) independently-configurable, power-limited output circuits for:
 - Class B and/or Class A NACs
 - Class B and/or Class A resettable or non-resettable 24V auxiliary power
 - door holder power
- Converts from Class B to Class A wiring without losing any outputs using the ZNAC-PS converter card (sold separately)
- Optimal for powering four-wire smoke detectors, annunciators, and other system peripherals requiring regulated power
- Optional addressable control, monitor, and relay modules and power-supervision relay (EOLR-1)
- Configurable for ANSI® Temporal 3 or Temporal 4 coded output
- UL-Listed NAC synchronization using System Sensor®, Wheelock®, Gentex®, or AMSECO® appliances
- Synchronization can be triggered from FACP NAC/remote sync outputs, cascaded power supply, or a control module, single or multi, which may be housed within the power supply cabinet
- Ability to cascade up to four power supplies
- Two (6 amp model) or three (10 amp model) fully-isolated input/control circuits which can be programmed to any output
- Two Form C normally-closed trouble relays for AC Trouble and General Trouble
- 6 or 10 amp full load output, respectively, with 3 A maximum/circuit
- Individual NAC power and trouble LEDs for diagnostic efficiency
- Trouble history mode for diagnostic support
- Wide range end-of-line supervision value (normal: 2-27K ohms)
- Selectable earth fault detection (enable or disable)
- AC trouble report delay timer
- Completely configurable via onboard DIP switches, no extra software required
- Self-contained in compact, locking cabinet constructed of heavy gauge steel with a corrosion-resistant powder coat chip and scratch-resistant finish
- Cabinet designed with ten double knockouts and a removable door for ease of installation and wiring
- Includes integral battery charger capable of charging up to 33 AH batteries
- Cabinet can house two 7 AH or 18 AH batteries
- Battery charger may be disabled via DIP switch for applications requiring larger batteries and external battery charger
- Removable terminal blocks accommodate up to 12 AWG (3.1mm²) wire
- Works with any UL 864 FACP which utilizes an industry-standard reverse-polarity notification circuit



HPF-PS6/10/E

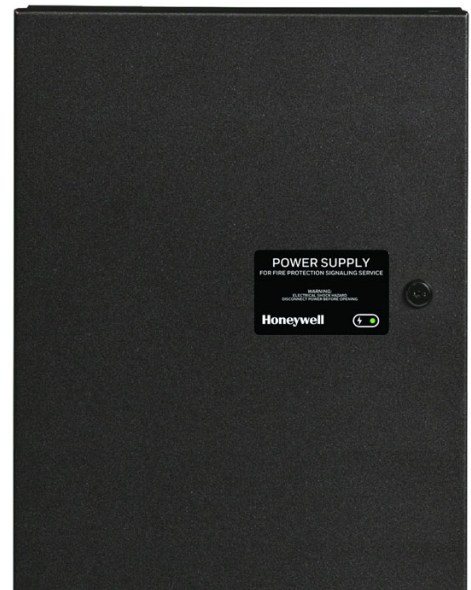

HPF-PS6B/10B/E

ORDERING INFORMATION

HPF-PS6: 6.0 A, 120 VAC remote charger power supply in a lockable, metal enclosure, red

HPF-PS6B: 6.0 A, 120 VAC remote charger power supply in a lockable, metal enclosure, black

HPF-PS6E: 6.0 A, 240 VAC remote charger power supply in a lockable, metal enclosure, red

HPF-PS10: 10.0 A, 120 VAC remote charger power supply in a lockable, metal enclosure, red

HPF-PS10B: 10.0 A, 120 VAC remote charger power supply in a lockable, metal enclosure, black

HPF-PS10E: 10.0 A, 240 VAC remote charger power supply in a lockable, metal enclosure, red

ZNAC-PS: Optional Class A converter card, sold separately

TC810N1013: Addressable Control Module for one Class B or Class A zone of supervised, polarized Notification Appliances. Notification Appliance Circuit option requires external 24 VDC to power notification appliances.

TC810R1024: Addressable relay module containing two isolated sets of Form-C contacts, which operate as a DPDT switch

TC809A1059: Addressable Monitor Module for one zone of normally open dry-contact initiating devices. Includes plastic cover plate and end-of-line resistor. Module may be configured for either a Class B or Class A

TC809D1004: Dual Monitor Module. Same as TC809A1059 except it provides two inputs for Class B wiring only

TC822A1010: Provides two monitored inputs and two Form-C relays. Functions in Class B wiring only

XP6-C: Six-circuit supervised control module

XP6-R: Six Form-C relay control module

EOLR-1: 12/24 VDC end-of-line relay for monitoring four-wire smoke detector power

BAT-1270-BP: Battery, 12 volt, 7.0 AH, 5-pack (two required)

BAT-12180-BP: Battery, 12 volt, 18AH, 2-pack

BAT-12330: Battery, 12 volt, 33AH

SEISKIT-MULTI-1: Seismic kit for the PS Series. Includes bracket and hardware for two 7AH or two 18AH batteries.

PS SERIES TECHNICAL SPECIFICATIONS

PRIMARY (AC) POWER

HPF-PS6(B): 120 VAC, 50/60 Hz, 5.0A maximum

HPF-PS10(B): 120VAC, 50/60 Hz, 6.2 A maximum

HPF-PS6E: 240 VAC, 50/60 Hz, 2.7A maximum

HPF-PS10E: 240 VAC, 50/60 Hz, 3.5A maximum

Wire Size: #12-14 AWG with 600 V insulation

COMMAND INPUT CIRCUIT

Trigger Input Voltage: 9 to 32 VDC

Trigger Current: 2.0 mA (16 - 32 V); Per Input: 1.0 mA (9 - 16 V)

RELAY CIRCUITS

Trouble Contact Rating: 4 A at 24 VDC

OUTPUT CIRCUITS

- 24 VDC filtered
- HPF-PS6(B): TB8-TB9 – 1A Regulated, 3A special applications; TB10-TB12 – 0.3A Regulated, 3A special applications
- HPF-PS10(B): TB8-TB11 – 1.5A Regulated, 3A special applications; TB12-TB14 – 0.3A Regulated, 3A special applications
- 6.0 A (HPF-PS6) or 10.0 (HPF-PS10) maximum total continuous current for all outputs

SECONDARY POWER (BATTERY) CHARGING CIRCUIT

- Supports lead-acid batteries only
- Float-charge voltage: 27.6 VDC
- Maximum current charge: 1.5 A
- Maximum battery capacity: 18 AH (inside cabinet)
- Maximum battery charging capacity: 33 AH (external cabinet)

PHYSICAL

Dimensions: 20.0”H x 14.5”W x 3.5”D (cm: 50.8H x 36.83W x 8.9D)

Weight: with two 7Ah batteries is 24 pounds (10.9 kg), with two 18 AH batteries is 39 pounds (17.7 kg)

STANDARDS AND CODES

The HPF-PS complies with the following standards:

NFPA 72: National Fire Alarm Code

UL 864: Standard for Control Units for Fire Alarm Systems (NAC expander mode)

UL 1481: Power Supplies for Fire Alarm Systems

AGENCY LISTINGS AND APPROVALS

These listings and approvals apply to the modules specified in this document. In some cases, certain modules or applications may not be listed by certain approval agencies, or listing may be in process. Consult factory for latest listing status.

UL Listed: S24562

CSFM: 7315-1637:0505

FDNY Approved

FM Approved

System Sensor® is a registered trademark of Honeywell International, Inc. Wheelock® is a registered trademark of Cooper Technologies Company. Gentex® is a registered trademark of Gentex Corporation. AMSECO® is a registered trademark of Potter Electric Signal Company, LLC. ANSI® is a registered trademark of the American National Standards Institute, Inc.

©2021 by Honeywell International Inc. All rights reserved. Unauthorized use of this document is strictly prohibited.

This document is not intended to be used for installation purposes. We try to keep our product information up-to-date and accurate. We cannot cover all specific applications or anticipate all requirements. All specifications are subject to change without notice.

Country of origin: USA

Honeywell Power Products

12 Clintonville Road
Northford, CT 06472-1610
203.484.7161
www.honeywellpower.com

DH-61094 | C | 03/21
©2021 Honeywell International Inc.

THE
FUTURE
IS
WHAT
WE
MAKE IT

Honeywell

LCD2-80

Liquid Crystal Display Terminal Mode/ACS Mode Annunciator

Annunciators

General

The LCD2-80 is a backlit LCD annunciator for the NOTIFIER fire alarm control panels, or network control annunciators that support the 80-character display format. LCD2-80s may be connected onto the four-wire EIA-485 terminal port.

The LCD2-80 mimics the display of NFS2-640, NFS2-3030, NFS-320, NCA-2 and legacy panels that supported the LCD-80/LCD-80TM. The NFS2-3030 and the NCA-2 also support LCD2-80s when set for LCD-80 supervision. Up to 32 LCD2-80s can annunciate and provide remote reset, acknowledge, drill and silence of the control panel from remote locations.

Features

- 80-character backlit Liquid Crystal Display (20 characters x 4 lines).
- Display mimics panel or NCA:
 - Event message.
 - 20 characters for point label.
 - 12 characters for extended label.
 - Time, date and point address.
- Control switches for System Acknowledge, Signal Silence Drill and System Reset.
- LEDs for general off-normal events with UL 864 9th Edition Panels.

NOTE: The LEDs are only applicable when used with UL 864 Ninth Edition listed panels: NFS-320, NFS2-640, NFS2-3030, and NCA-2.
- ACS mode option for annunciation of user selected points. (VeriFire Tools 6.90 or higher required to program points.)
- Up to 6000 foot segments between units.
- Local piezo sounder with alarm/trouble resound.
- Displays all analog, addressable points.
- Displays device type identifiers.
- Displays device and zone custom alpha labels.

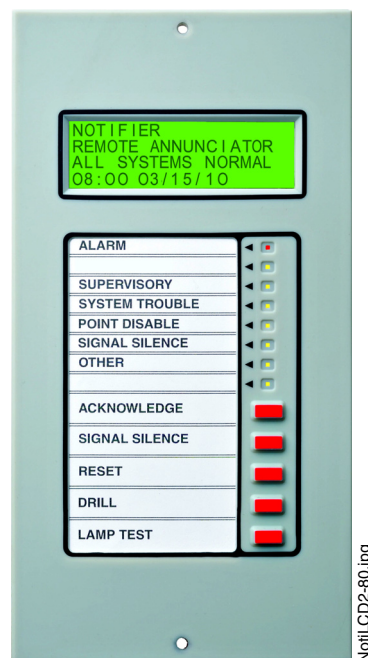

- LCD2-80 mounts with any CHS-4 chassis slot.
- Slide-in label can be customized.
- Flush/surface/panel mount option.
- LCD2-80 displays time, date, and custom messages received from the compatible panel or network annunciator.
- LCD2-80 is 8.25" (20.96 cm) high, 4.375" (11.11 cm) wide, and 1.75" (4.45 cm) deep.
- Up to 32 LCD2-80s may be used on one EIA-485 circuit.

NOTE: Must have sufficient regulated 24 volt power.

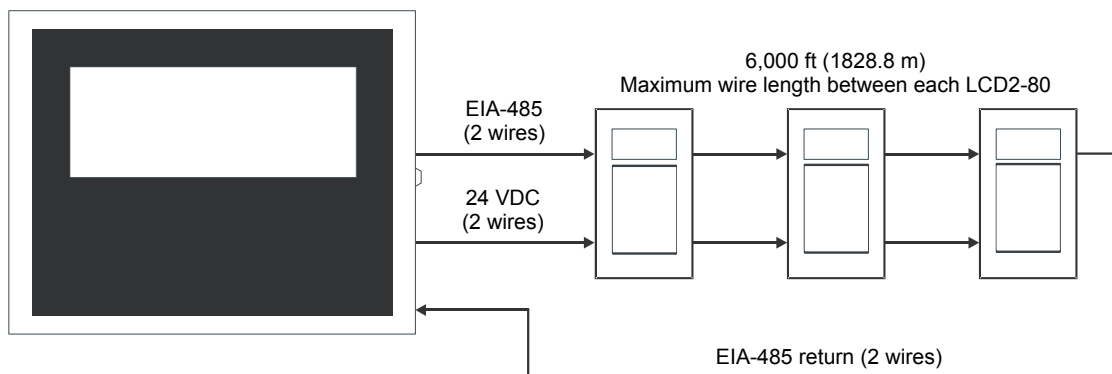

NFS-320, NFS2-640, NFS2-3030, or NCA-2 connecting to LCD2-80

The ABF-1DB Backbox

The **ABF-1DB** is a semi-flush-mount backbox for the NOTIFIER LCD2-80 Series Annunciator. The ABF-1DB mounts one LCD2-80. It includes an attractive smoked-glass door with NOTIFIER keylock.

- **Dimensions, BOX only:** 9.938" (25.24 cm) high, 4.625" (11.75 cm) wide, 2.5" (6.35 cm) deep.
- **Dimensions, DOOR only:** 10.713" (27.21 cm) high, 6.0" (15.24 cm) wide, 0.75" (1.9 cm) deep.

Related Options

"C" suffix indicates ULC-Listed model.

ABF-1DB(C): Semi-flush box with alternative smoked-glass door, any keylock.

ADP-4B: Annunciator dress plate, black. Allows panel mounting of up to four LCD2-80 modules in a CAB-4 Series cabinet.

ABF-1B(C): Annunciator flush box, 9.938" (25.24 cm) high, 4.625" (11.75 cm) wide, and 2.5" (6.35 cm) deep. Order AKS-1B key switch and APJ-1B phone jack if desired. Can also be mounted in ABF-2B or ABF-4B annunciator backboxes.

ABS-1TB(C): Deep surface backbox (mounts one LCD2-80).

ABS-1B(C): The Annunciator Surface Box-1B (black) provides for the remote mounting of one annunciator module in a surface-mount enclosure. Knockouts are provided for use with 1/2" (1.27 cm) conduit. The annunciator mounts directly to the ABS-1B/C without a dress plate. 8.5" (21.59 cm) high x 4.5" (11.43 cm) wide x 2" (5.08 cm) deep. **NOTE:** The ABS-1B will not support the installation of the AKS-1B Annunciator Key Switch.

ABS-2B: Annunciator surface box, 8.5" (21.59 cm) high x 8.92" (22.66 cm) x 2" (5.08 cm) deep. Knockouts are provided for use with 1/2" (1.27 cm) conduit. The annunciators mount directly to the ABS-2B without a dress plate.

ABS-2D(C): Annunciator backbox, surface, black. UL/ULC Listed.

ABF-2B: Annunciator flush box, 9.938" (25.24 cm) high x 9.188" (23.34 cm) wide x 3.75" (9.525 cm) deep. Includes a painted metal trim plate [11" (27.94 cm) high x 10.625" (26.99 cm) wide] and adhesive-backed annunciator label.

ABF-2DB(C): Annunciator semi-flush mount backbox. Black with a smoked glass door with a keylock.

ABS-4D(C): The ABS-4D/C is a semi-flush-mount backbox for the ACS Series Annunciators. It mounts up to four modules, and can also accommodate the NCA-2 network annunciator, using the NCA-2 Retro Kit (NCA-2Retro); the NCA-2 is mounted in the center position with a blank plate (BMP-1) mounted on each side. Black with an attracted smoked glass door and keylock. The **ABS-4D** is hinged on the bottom for stability.

AKS-1B: Key Switch (black) to enable/disable controls when mounted in ABF-1B or ABS-1TB.

Agency Listings and Approvals

These listings and approvals apply to the modules specified in this document. In some cases, certain modules or applications

may not be listed by certain approval agencies, or listing may be in process. Consult factory for latest listing status.

- **UL Listed:** S635.
- **ULC Listed:** S527-11.
- **FDNY:** COA# 6212, 6211.
- **CSFM:** 7165-0028:0243, 7165-0028-0224.
- **FM Approved.**

Notifier® and VeriFire® Tools are registered trademarks of Honeywell International Inc.

©2017 by Honeywell International Inc. All rights reserved. Unauthorized use of this document is strictly prohibited.



This document is not intended to be used for installation purposes.
We try to keep our product information up-to-date and accurate.
We cannot cover all specific applications or anticipate all requirements.
All specifications are subject to change without notice.



Country of Origin: USA

For more information, contact Notifier. Phone: (203) 484-7161, FAX: (203) 484-7118.
www.notifier.com

HW-AV-LTE-M CLSS PATHWAY

Connected Life Safety Services (CLSS) Dual-Path LTE Communicator with Dial Capture Interface

The Honeywell® CLSS Pathway is a differentiated communications platform with dual support for AT&T® and Verizon® and integrated features powered by the CLSS Cloud.

The CLSS Pathway combines dial capture functionality with the powerful capabilities of Honeywell's CLSS Cloud. It represents the latest alarm communications technology for the fire industry. The CLSS Pathway allows data transmission by utilizing LTE CAT-M1 networks, serving as a bridge between the fire system and the CLSS Cloud.

This device provides a single site-to-cloud path ensuring all CLSS Cloud services use the same audited and monitored method to access the on-premises life safety system.

HONEYWELL CONNECTED LIFE SAFETY SERVICES (CLSS)

Honeywell CLSS is an innovative, all-in-one cloud platform that enables systems integrators and facilities managers to deliver an enhanced fire safety service, while maximizing the performance efficiencies offered by Honeywell's trusted detection and alarm systems. The CLSS platform enables users to:

- Get a "bird's eye" view of all accounts
- Obtain real-time information on event generation, enabling diagnosis before dispatch
- Conduct tests and inspections using a mobile app (available in select markets)
- Provide end users with multi-site asset information and event alerts

DUAL AT&T AND VERIZON SUPPORT

Equipped with dual SIM cards, the CLSS Pathway supports both AT&T and Verizon networks. When first powered on, the communicator selects the strongest signal. If either path is not available, the device provides redundant paths for the cellular signal.

SIMPLIFIED INSTALLATION

The CLSS Pathway is commissioned via the CLSS mobile app and CLSS Site Manager interface, which also allow for additional remote visibility.

Connection and mounting is simplified using the enclosure kit. The CLSS Pathway is compatible with any fire alarm dialer using Contact ID format and automatically recognizes the format when powered up. Any number can be programmed into the panel phone numbers. Installers can select the central station service they wish to use from a list of approved central station providers. Only account numbers assigned by the central station must be programmed and the dialer selected for tone dialing output.

FEATURES AND BENEFITS

- Integration with CLSS enables monitoring of event transmission data & management of device inventory from the CLSS mobile app and web portal (available only when using point-based reporting)
- Meets UL 864 requirements for sole primary or backup path communications
- High reliability due to multiple transmission channels (LTE CAT-M1/LAN) and redundant servers
- Universal Panel Compatibility - Dial capture interface supporting Contact ID
- Four supervised inputs for non-dialer panels
- Unique "M1" Network is 5G ready, providing deep signal penetration that allows operation within buildings
- Remote firmware updates
- CLSS mobile app supports push and email notifications
- Monitors event transmission data & manages device inventory from the CLSS mobile app and web portal
- Exceptional Redundancy - Dual-SIM device picks the strongest signal from AT&T or Verizon. If one network becomes unavailable, the communicator connects to the other network
- Powered directly by a 24-volt DC fire alarm power supply. No need for additional batteries, transformer, or power supply
- Connection monitoring - adjustable fault reporting time as low as 20 seconds
- Web-based software and smartphone app for device configuration and administration.



Metal enclosure (HW-AV-ENC) for housing CLSS Pathway (HW-AV-LTE-M)

Honeywell

HW-AV-LTE-M TECHNICAL SPECIFICATIONS

Characteristics	Imperial Unit	Metric Unit
Electrical		
Supply Voltage	+12 to +29 VDC	
Power Consumption	<ul style="list-style-type: none">Standby: 60 mAPeak: 200 mA	
Frequency	LTE CAT-M1 700/850/1700/1900/2100 MHz	
Environment		
Operating Temperature	32°F to 120°F	0°C to 49°C
Relative humidity:	1% to 85% Non-condensing	
Physical		
Dimensions	3.54" L x 2.48" W x 1.26" D	90 mm L x 63 mm W x 32 mm D
Weight (without antenna)	2.56 oz	72.57 gm
RoHS	Yes	
Network Providers		
<ul style="list-style-type: none">AT&T, North AmericaVerizon, North AmericaOther provider in the area networks		

AGENCY LISTINGS AND APPROVALS

The listings and approvals below apply to the HW-AV-LTE-M Communicator. In some cases, certain modules may not be listed by certain approval agencies, or listing may be in process. Contact Honeywell for the latest listings.

STANDARDS AND CODES

The HW-AV-LTE-M is designed to comply with UL 864 - Control Units and Accessories for Fire Alarm Systems Units

APPROVALS

- ETL Listed
- FCC
- CSFM: 7300-1637:0511

ORDERING INFORMATION

- HW-AV-LTE-M: Dual-Path** Communicator with Dial Capture Interface only. Includes antenna.
- HW-AV-ENC:** Enclosure for the CLSS Pathway (HW-AV-LTE-M)

CUSTOMER SUPPLIED EQUIPMENT

Mobile Device for LTE Communicator configuration (either iOS or Android).

Android™ is a trademark of Google, Inc.

AT&T® is a registered trademark of the AT&T Properties, L.P.

Honeywell® is a registered trademark of Honeywell International, Inc.

iOS® is a registered trademark of Cisco Systems Inc. licensed by Apple Inc.

Verizon® is a registered trademark of Verizon Trademark Services LLC.

This document is not intended to be used for installation purposes. We try to keep our product information up-to-date and accurate. We cannot cover all specific applications or anticipate all requirements. All specifications are subject to change without notice.

DNR(A) and DNRW Intelligent Photoelectric Duct Detectors

The Notifier DNR(A) intelligent non-relay photoelectric duct smoke detector and DNRW watertight non-relay photoelectric duct smoke detector feature a pivoting housing that fits both square and rectangular footprints capable of mounting to a round or rectangular duct.

The DNRW duct smoke detector, with its NEMA-4 rating, is listed as a watertight, UV resistant enclosure providing protection against falling dirt, rain, and windblown dust, splashing and hose directed water, allowing operators to use the detector in the most extreme environments.

These units sense smoke in the most challenging conditions, operating in airflow speeds of 100 to 4,000 feet per minute (0.5 – 20.32 m/s), temperatures of -4°F – 158°F (-20°C – 70°C), and a humidity range of 0 – 95 percent (non-condensing.)

An improved cover design isolates the sensor head, which allows for ease of maintenance. A cover tamper feature indicates a trouble signal for a removed or improperly installed sensor cover. The housing provides a 3/4-inch conduit knockout and ample space to facilitate easy wiring and mounting of a relay module.

The Notifier DNR(A) duct smoke detectors can be customized to meet local codes and specifications without additional wiring and are compatible with all previous models, including remote test accessories.

Features

- Photoelectric, integrated low-flow technology
- Air velocity rating from 100 ft/min – 4,000 ft/min (0.5 m/s – 20.32 m/s)
- Versatile mounting options: square or rectangular configuration
- Broad ranges for operating temperature (-4°F – 158°F, -20°C – 70°C) and humidity (0% – 95% non-condensing)
- Patented sampling tube installs from front or back of the detector with no tools required
- Cover tamper signal
- Increased wiring space with a newly added 3/4" conduit knockout
- Available space within housing to accommodate mounting of a relay module
- Easily accessible code wheels on sensor head (sold separately)
- Clear cover for convenient visual inspection
- Remote testing capability
- Requires com line power only
- Accommodates an addressable relay module, sold separately, (FRM-1) for applications requiring a Form-C relay

Specifications

Size: (Rectangle) 14.38 in (37 cm) Length; 5 in (12.7 cm) Width, 2.5 in (6.6 cm) Depth

Size: (Square) 7.75 in (19.7 cm) Length; 9 in (22.9 cm) Width; 2.5 in (6.35 cm) Depth

Weight: 1.6 lb (0.73 kg)

Operating Temperature Range: -4°F – 158°F (-20°C – 70°C)

Storage Temperature Range: -22°F – 158°F (-30°C – 70°C)

Operating Humidity Range: 0% – 95% relative humidity (non-condensing)

Air Duct Velocity: 100 – 4,000 ft/min (0.5 – 20.32 m/s)

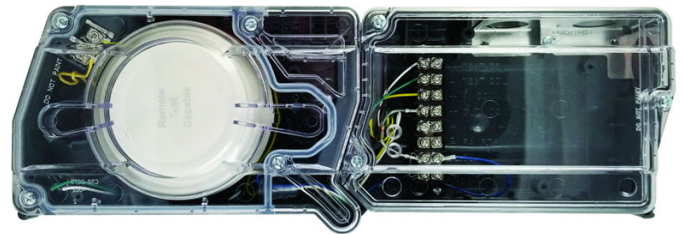

Accessories

Notifier provides system flexibility with a variety of accessories, including two remote test stations and different means of visible and audible system annunciation. As with our duct smoke detectors, all duct smoke detectors accessories are UL listed.

DNR(W) housings with a date code of 0013 or higher do not require external 24VDC for remote test applications when used with a remote-test-capable detector.

ACCESSORY CURRENT LOADS AT 24 VDC

Device	Standby	Alarm
RA100Z	0mA	12mA Max
RTS151/RTS151KEY	0mA	12mA Max

Agency Listings and Approvals

Consult product manual for lists of compatible UL-Listed devices. In some cases, certain modules may not be listed by certain approval agencies, or listing may be in process. Consult factory for latest listing status.

- **UL:** S635, S3705
- **ULC:** S635
- **CSFM:** 3240-1653:0209
- **FM approved**

Product Line Information

NOTE: "A suffix indicates ULC listed model.

DNR(A): Intelligent non-relay photoelectric low flow smoke detector housing. Requires photoelectric smoke detector (sold separately).

DNRW: Watertight intelligent non-relay photoelectric low flow duct smoke detector housing. Requires photoelectric smoke detector (sold separately). NEMA-4 rated.

FSP-951R(A)-IV: Remote test capable addressable low-profile photoelectric smoke detector; ivory; supports CLIP and FlashScan® protocols

FSP-951R(A): Remote test capable addressable low-profile photoelectric smoke detector; white; supports FlashScan protocol only

FSP-951(A)-IV: Addressable low-profile photoelectric smoke detector; ivory; supports CLIP and FlashScan protocols

FSP-951R(A): Addressable low-profile photoelectric smoke detector; white; supports FlashScan protocol only

DCOIL: Remote test coil. Required for older DNR(W) duct detector housing

DUCTCOV: Retrofit DNR cover for manufactured prior to April 2014

DUCTCOVW: Retrofit DNRW cover for manufactured prior to April 2014

DST1(A): Metal sampling tube duct width up to 1 ft (0.3m)

DST1.5(A): Metal sampling tube duct widths up to 1 ft – 2 ft (0.3 – 0.6 m)

DST3(A): Metal sampling tube duct widths up to 2 ft – 4 ft (0.6 – 1.2 m)

DST5(A): Metal sampling tube duct widths up to 4 ft – 8 ft (1.2 – 2.4 m)

DST10(A): Metal sampling tube duct widths up to 8 ft – 12 ft (2.4 – 3.7 m)

DH400OE-1: Weatherproof enclosure

ETX: Metal exhaust tube duct, width 1 ft (0.3 m)

M02-04-00: Test magnet

P48-21-00: End cap for metal sampling tubes

RA100Z(A): Remote annunciator alarm LED

RTS151(A): Remote test station

RTS151KEY(A): Remote test station with key lock

Important Notes

- DNR(W) duct detector housings with a date code of 0013 or higher do not require a DCOIL or auxiliary 24 VDC for remote test applications when used with a remote test capable detector.
- DNR(W) duct detector housings with a date code of 0012 or earlier require a DCOIL and auxiliary 24 VDC power for remote test applications.



This document is not intended to be used for installation purposes.

We try to keep our product information up-to-date and accurate.

We cannot cover all specific applications or anticipate all requirements.

All specifications are subject to change without notice.

NOTIFIER

12 Clintonville Road

Northford, CT 06472

203.484.7161

www.notifier.com

Notifier® and FlashScan® are a registered trademark of Honeywell International Inc.

©2019 by Honeywell International Inc. All rights reserved. Unauthorized use of this document is strictly prohibited.

Country of Origin: Mexico



NBG-12LX

Addressable Manual Pull Station



Intelligent/Addressable Devices

General

The Notifier NBG-12LX is a state-of-the-art, dual-action (i.e., requires two motions to activate the station) pull station that includes an addressable interface for any Notifier intelligent control panel except FireWarden series panels, and the NSP-25 panel. Because the NBG-12LX is addressable, the control panel can display the exact location of the activated manual station. This leads fire personnel quickly to the location of the alarm.

Features

- Maintenance personnel can open station for inspection and address setting without causing an alarm condition.
- Built-in bicolor LED, which is visible through the handle of the station, flashes in normal operation and latches steady red when in alarm.
- Handle latches in down position and the word “ACTIVATED” appears to clearly indicate the station has been operated.
- Captive screw terminals wire-ready for easy connection to SLC loop (accepts up to 12 AWG/3.25 mm² wire).
- Can be surface mounted (with SB-10 or SB-I/O) or semi-flush mounted. Semi-flush mount to a standard single-gang, double-gang, or 4" (10.16 cm) square electrical box.
- Smooth dual-action design.
- Meets ADAAG controls and operating mechanisms guidelines (Section 4.1.3[13]); meets ADA requirement for 5 lb. maximum activation force.
- Highly visible.
- Attractive shape and textured finish.
- Key reset.
- Includes Braille text on station handle.
- Optional trim ring (BG12TR).
- Meets UL 38, Standard for Manually Actuated Signaling Boxes.
- Up to 99 NBG-12LX stations per loop on CLIP protocol loops.
- Up to 159 NBG-12LX stations per loop on FlashScan® protocol loops.
- Dual-color LED blinks green to indicate normal on FlashScan® systems.

Construction

Shell, door, and handle are molded of durable polycarbonate material with a textured finish.

Specifications

- **Shipping Weight:** 9.6 oz. (272.15 g)
- **Normal operating voltage:** 24 VDC.
- **Maximum SLC loop voltage:** 28.0 VDC.
- **Maximum SLC standby current:** 375 µA.
- **Maximum SLC alarm current:** 5 mA.
- **Temperature Range:** 32°F to 120°F (0°C to 49°C)
- **Relative Humidity:** 10% to 93% (noncondensing)
- **For use indoors in a dry location**



The NBG-12LX
Addressable Manual Pull Station

Installation

The NBG-12LX will mount semi-flush into a single-gang, double-gang, or standard 4" (10.16 cm) square electrical outlet box, or will surface mount to the model SB-10 or SB-I/O surface backbox. If the NBG-12LX is being semi-flush mounted, then the optional trim ring (BG12TR) may be used. The BG12TR is usually needed for semi-flush mounting with 4" (10.16 cm) or double-gang boxes (not with single-gang boxes).

Operation

Pushing in, then pulling down on the handle causes it to latch in the down/activated position. Once latched, the word “ACTIVATED” (in bright yellow) appears at the top of the handle, while a portion of the handle protrudes from the bottom of the station. To reset the station, simply unlock the station with the key and pull the door open. This action resets the handle; closing the door automatically resets the switch.

Each manual station, on command from the control panel, sends data to the panel representing the state of the manual switch. Two rotary decimal switches allow address settings (1 – 159 on FlashScan® systems, 1 – 99 on CLIP systems).

Architectural/Engineering Specifications

Manual Fire Alarm Stations shall be non-coded, with a key-operated reset lock in order that they may be tested, and so designed that after actual Emergency Operation, they cannot be restored to normal except by use of a key. An operated station shall automatically condition itself so as to be visually detected as activated. Manual stations shall be constructed of red-colored polycarbonate material with clearly visible operating instructions provided on the cover. The word FIRE shall appear on the front of the stations in white letters, 1.00 inches (2.54 cm) or larger. Stations shall be suitable for surface mounting on matching backbox SB-10 or SB-I/O; or semi-flush mounting on a standard single-gang, double-gang, or

4" (10.16 cm) square electrical box, and shall be installed within the limits defined by the Americans with Disabilities Act (ADA) or per national/local requirements. Manual Stations shall be Underwriters Laboratories listed.

Manual stations shall connect with two wires to one of the control panel SLC loops. The manual station shall, on command from the control panel, send data to the panel representing the state of the manual switch. Manual stations shall provide address setting by use of rotary decimal switches.

The loop poll LED shall be clearly visible through the front of the station. The LED shall flash while in the normal condition, and stay steadily illuminated when in alarm.

Product Line Information

NBG-12LX: Dual-action addressable pull station. Includes key locking feature. (Listed for Canadian and non-Canadian applications.)

NBG-12LXSP: Spanish/English labelled version.

NBG-12LXP: Portuguese labelled version.

SB-10: Surface backbox; metal.

SB-I/O: Surface backbox; plastic.

BG12TR: Optional trim ring.

17021: Keys, set of two.

NY-Plate: New York City trim plate.

Agency Listings and Approvals

In some cases, certain modules or applications may not be listed by certain approval agencies, or listing may be in process. Consult factory for latest listing status.

- **UL/ULC Listed:** S692 (listed for Canadian and non-Canadian applications).
- **MEA:** 67-02-E.
- **CSFM:** 7150-0028:0199.
- **FDNY:** COA #6085 (NFS2-640), COA #6098 (NFS2-3030).
- **BSMI:** CI313066760047.
- **U.S. Coast Guard.**
- **Lloyd's Register.**
- **FM Approved.**

Patented: U.S. Patent No. D428,351; 6,380,846; 6,314,772; 6,632,108.

NOTIFIER® and FlashScan® are registered trademarks of Honeywell International Inc.

©2012 by Honeywell International Inc. All rights reserved. Unauthorized use of this document is strictly prohibited.



This document is not intended to be used for installation purposes.
We try to keep our product information up-to-date and accurate.
We cannot cover all specific applications or anticipate all requirements.
All specifications are subject to change without notice.



Made in the U.S. A.

For more information, contact Notifier. Phone: (203) 484-7161, FAX: (203) 484-7118.
www.notifier.com

FSP-951 Series

Intelligent Plug-In Photoelectric Smoke Detectors



Intelligent/Addressable Devices

General

The NOTIFIER FSP-951 Series intelligent plug-in smoke detectors are designed for both performance and aesthetics. A new modern, sleek, contemporary design and enhanced optical sensing chamber is engineered to sense smoke produced by a wide range of combustion sources in accordance with more stringent code standards. The FSP-951 Series detector sensitivity can be programmed in the control panel software. Sensitivity is continuously monitored and reported to the panel. Point ID capability allows each detector's address to be set with rotary, decimal address switches, providing exact detector location for selective maintenance when chamber contamination reaches an unacceptable level. Dual electronic thermistors add 135°F (57°C) fixed temperature thermal sensing on the FSP-951T. The FSP-951R is a remote test capable detector for use with DNR Series duct detector housings. FSP-951 series detectors are available for both FlashScan® and CLIP applications as designated.

Features

- New modern profile for improved aesthetics.
- Designed to meet UL268 7th Edition.
- Stable communication technique with noise immunity.
- Low standby current.
- Two-wire SLC connection.
- Compatible with FlashScan® and CLIP protocol systems.
- Rotary, decimal addressing (1-99 on CLIP systems, 1-159 on FlashScan systems).
- Optional remote, single-gang LED accessory.
- Dual LED design provides 360° viewing angle.
- Visible bi-color LEDs blink green every time the detector is addressed, and illuminate steady red on alarm (*FlashScan systems only*).
- Remote test feature from the panel.
- Walk test with address display (an address on 121 will blink the detector LED: 12-[pause]-1 (*FlashScan systems only*)).
- Built-in functional test switch activated by external magnet.
- Built-in tamper-resistant feature.
- Sealed against back pressure.
- Expanded color options.
- SEMS screws for wiring of the separate base.
- Optional relay, isolator, and sounder bases.

Specifications

Sensitivity:

- UL Applications: 0.5% to 4.0% per foot obscuration.
- ULC Applications: 0.5% to 3.5% per foot obscuration.

Size: 2.0" (5.3 cm) high; base determines diameter.

- B300-6: 6.1" (15.6 cm) diameter.
- B501: 4" (10.2 cm) diameter.

For a complete list of detector bases see DN-60981.

Shipping weight: 3.4oz (96.4g)

Operating Temperature range:

- FSP-951, 0°C to 50°C (32°F to 122°F).
- FSP-951T, 0°C to 38°C (32°F to 100°F).



FSP-951 in B300-6 Base

- FSP-951R installed in a DNR/DNRW, -20°C to 70°C (-4°F to 158°F).

UL/ULC Listed Velocity Range: 0-4000 ft/min. (1219.2 m/min.), suitable for installation in ducts.

Relative Humidity: 10%-93% noncondensing.

Thermal Ratings: Fixed-temperature setpoint 135°F (57°C).

DETECTOR SPACING AND APPLICATIONS

NOTIFIER recommends spacing detectors in compliance with NFPA 72. In low airflow applications with smooth ceiling, space detectors 30 feet (9.1m). For specific information regarding detector spacing, placement, and special applications refer to NFPA 72. *System Smoke Detector Application Guide*, document A05-1003, is available at systemsensor.com

ELECTRICAL SPECIFICATIONS

Voltage Range: 15-32 volts DC peak.

Standby Current (max. avg.): 200µA @ 24VDC (one communication every five seconds with LED enabled).

LED Current (max.): 4.5mA @ 24 VDC ("ON").

Installation

FSP-951 series plug-in detectors use a separate base to simplify installation, service, and maintenance.

Mount base (all base types) on an electrical backbox which is at least 1.5" (3.81 cm) deep. For a chart of compatible junction boxes, see DN-60981.

NOTE: 1) Because of inherent supervision provided by the SLC loop, end-of-line resistors are not required. Wiring "T-taps" or branches are permitted for Style 4 (Class "B") wiring. 2) When using relay or sounder bases, consult the ISO-X(A) installation sheet I56-1380 for device limitations between isolator modules and isolator bases.

Agency Listings and Approvals

These listings and approvals apply to the detectors specified in this document. In some cases, certain detectors or applications may not be listed by certain approval agencies, or listing may be in process. Consult factory for latest listing status.

- UL/ULC Listed: S911
- FM Approved
- CSFM: 7272-0028:0503

Product Line Information

NOTE:

- Detectors must be mounted to one of the Intelligent Bases listed below.
- "A" suffix indicates ULC Listed model.
- "IV" suffix indicates FlashScan® and CLIP device.

FSP-951: White, low-profile intelligent photoelectric sensor, FlashScan only.

FSP-951A: Same as FSP-951 but with ULC listing.

FSP-951-IV: Ivory, low-profile intelligent photoelectric sensor.

FSP-951A-IV: Same as FSP-951-IV but with ULC listing.

FSP-951T: White, same as FSP-951 but includes a built-in 135°F (57°C) fixed-temperature thermal device. FlashScan only.

FSP-951TA: Same as FSP-951T but with ULC listing.

FSP-951T-IV: Ivory, same as FSP-951T but includes a built-in 135°F (57°C) fixed-temperature thermal device.

FSP-951TA-IV: Same as FSP-951T-IV but with ULC listing.

FSP-951R: White, low-profile intelligent photoelectric sensor, remote test capable. For use with DNR/DNRW. FlashScan only.

FSP-951RA: Same as FSP-951R but with ULC listing. For use with DNRA.

FSP-951R-IV: Ivory, low-profile intelligent photoelectric sensor, remote test capable. For use with DNR/DNRW.

FSP-951RA-IV: Same as FSP-951R-IV but with ULC listing. For use with DNRA.

INTELLIGENT BASES

NOTE: For details on intelligent bases, see DN-60981

B300-6: White, 6" base, standard flanged low-profile mounting base.

B300-6-IV: Ivory, 6" base, standard flanged low-profile mounting base.

B300A-6: Same as B300-6, ULC listed.

B300A-6-IV: Ivory, 6" standard flanged low-profile mounting base, ULC listed.

B300-6-BP: Bulk pack of B300-6, package contains 10

B501-WHITE: White, 4" standard European flangeless mounting base. UL/ULC listed.

B501-BL: Black, 4" standard European flangeless mounting base. UL/ULC listed.

B501-IV: Ivory color, 4" standard European flangeless mounting base. UL/ULC listed.

B501-WHITE-BP: Bulk pack of B501-WHITE contains 10.

B224RB-WH: White, relay base.

B224RB-IV: Ivory, relay base.

B224RBA-WH: White, relay base, ULC listing.

B224RBA-IV: Ivory, relay base, ULC listing.

B224BI-WH: White, *isolator* detector base.

B224BI-IV: Ivory *isolator* detector base.

B224BIA-WH: White, *isolator* detector base, ULC listing.

B224BIA-IV: Ivory *isolator* detector base, ULC listing.

B200S-WH: White, Intelligent addressable sounder base capable of producing sound output in high or low volume with ANSI Temporal 3, ANSI Temporal 4, continuous tone, marching tone, and custom tone. Uses FlashScan protocol.

B200S-IV: Ivory, Intelligent addressable sounder base capable of producing sound output in high or low volume with ANSI Temporal 3, ANSI Temporal 4, continuous tone, marching tone, and custom tone. Uses FlashScan protocol.

B200SA-WH: Same as B200S-WH, ULC listing.

B200SA-IV: Same as B200S-IV, ULC listing.

B200SCOA-WH: White, Intelligent, programmable sounder base in English/French (required in Canada for ULC applications with SO Series detector applications).

B200SCOA-IV: Ivory Intelligent, programmable sounder base in English/French (required in Canada for ULC applications with SO Series detector applications, ULC listing).

B200S-LF-WH: White, Low Frequency Intelligent, programmable sounder base. Produces a fundamental frequency of 520 Hz +/- 10% with a square wave or its equivalent; designed to meet the NFPA 72 sleeping space requirement.

B200S-LF-IV: Ivory, Low Frequency Intelligent, programmable sounder base. Produces a fundamental frequency of 520 Hz +/- 10% with a square wave or its equivalent; designed to meet the NFPA 72 sleeping space requirement.

B200SR-WH: White, Intelligent sounder base capable of producing sound output with ANSI Temporal 3 or continuous tone. Intended for retrofit applications.

B200SR-IV: Ivory, Intelligent sounder base capable of producing sound output with ANSI Temporal 3 or continuous tone. Intended for retrofit applications.

B200SRA-WH: Same as B200SR-WH with, ULC listing.

B200SRA-IV: Same as B200SR-IV in Ivory color, ULC listing.

B200SR-LF-WH: White, Low Frequency Intelligent, programmable sounder base. Produces a fundamental frequency of 520 Hz +/- 10% with a square wave or its equivalent; designed to meet the NFPA 72 sleeping space requirement. Intended for retrofit applications.

B200SR-LF-IV: Ivory, Low Frequency Intelligent, programmable sounder base. Produces a fundamental frequency of 520 Hz +/- 10% with a square wave or its equivalent; designed to meet the NFPA 72 sleeping space requirement. Intended for retrofit applications.

MOUNTING KITS AND ACCESSORIES

TR300: White, replacement flange for B210LP(A) base.

TR300-IV: Ivory, replacement flange for B210LP(A) base.

RA100Z(A): Remote LED annunciator. 3 – 32 VDC. Mounts to a U.S. single-gang electrical box. For use with B501(A) and B300(A)-6.

M02-04-00: Test magnet.

M02-09-00: Test magnet with telescoping handle.

©2018 by Honeywell International Inc. All rights reserved. Unauthorized use of this document is strictly prohibited.



This document is not intended to be used for installation purposes.
We try to keep our product information up-to-date and accurate.
We cannot cover all specific applications or anticipate all requirements.
All specifications are subject to change without notice.

For more information, contact Notifier. Phone: (800) 627-3473, FAX: (203) 484-7118.
www.notifier.com

FST-951 Series Intelligent Addressable Heat Detectors

The NOTIFIER[®] FST-951 Series intelligent thermal detectors are designed for both performance and aesthetics, and are direct replacements for the FST-851 Series. A new modern, sleek, contemporary design and advanced thermal technologies make the FST-951 Series ideal for both system operation and building design. The point ID address, set using rotary decimal switches, provide specific detector locations.

The series includes a 135°F/57°C fixed-temperature, rate-of-rise, and a 190°F/88°C fixed high-temperature detectors. These thermal detectors provide effective, intelligent property protection in a variety of applications. Detectors are available for both FlashScan[®] and CLIP applications as designated.

Features

SLC LOOP:

- Two-wire SLC loop connection
- Unit uses base for wiring

ADDRESSING:

- Addressable by device
- Rotary, decimal addressing
(Refer to the *NOTIFIER panel manuals* for device capacity.)

ARCHITECTURE:

- Designed to meet UL 268 7th Edition
- Sleek, low-profile, stylish design
- State-of-the-art thermistor technology for fast response
- Integral communications and built-in device-type identification
- Built-in tamper resistant feature
- Built-in functional test switch activated by external magnet

OPERATION:

- Fixed temperature model (FST-951) factory preset to 135°F (57°C)
- Rate-of-rise model (FST-951R), 15°F (8.3°C) per minute
- High-temperature model (FST-951H) factory preset to 190°F (88°C)
- 360°-field viewing angle of the two visual alarm indicators, LEDs blink red in Normal condition and turn on steady red in Alarm
- LEDs blink every time the unit is polled

MECHANICALS:

- Sealed against back pressure
- SEMS screws for wiring of the separate base
- Designed for direct-surface or electrical-box mounting
- Plugs into separate base for ease of installation and maintenance
- Separate base allows interchange of photoelectric, ionization and thermal sensors

OTHER SYSTEM FEATURES:

- Remote test feature from the panel
- Walk test with address display
- Low standby current

OPTIONS:

- Remote LED output connection to optional RA100Z remote LED annunciator



Installation

FST-951 Series plug-in intelligent thermal detectors use a detachable base to simplify installation, service and maintenance. Installation instructions are shipped with each detector.

Mount detector base (all base types) on an electrical backbox which is at least 1.5" (3.81 cm) deep. For a chart of compatible junction boxes, see *DN-60054*.

NOTE: Because of the inherent supervision provided by the SLC loop, end-of-line resistors are not required. Wiring "T-taps" or branches are permitted for Style 4 (Class "B") wiring only. When using relay or sounder bases, consult the ISO-X(A) installation sheet 156-1380 for device limitations between isolator modules and isolator bases.

Applications

Use thermal detectors for protection of property. For further information, refer to 156-6522, Applications Manual for System Smoke Detectors, which provides detailed information on detector spacing, placement, zoning, wiring, and special applications.

Construction

These detectors are constructed of fire-resistant plastic. The FST-951 Series plug-in intelligent thermal detectors are designed to commercial standards and offer an attractive appearance.

Operation

Each FST-951 Series detector uses one of the panel's addresses (total limit is panel dependent) on the NOTIFIER Signaling Line Circuit (SLC). It responds to regular polls from the control panel and reports its type and the status. If it receives a test command from the panel (or a local magnet test), it stimulates its electronics and reports an alarm. It blinks its LEDs when polled and turns the LEDs on when commanded by the panel. The FST-951 Series offers features and performance that represent the latest in thermal detector technology.

Product Line Information

NOTE: “-IV” suffix indicates CLIP and FlashScan device.

FST-951: White, low-profile intelligent 135°F fixed thermal sensor, FlashScan only

FST-951A: Same as FST-951 but with ULC listing

FST-951-IV: Ivory, low-profile intelligent 135°F fixed thermal sensor, FlashScan and CLIP

FST-951A-IV: Same as FST-951-IV but with ULC listing

FST-951R: White, low-profile intelligent rate-of-rise thermal sensor, FlashScan only

FST-951RA: Same as FST-951 but with ULC listing

FST-951R-IV: Ivory, low-profile intelligent rate-of-rise fixed thermal sensor, FlashScan and CLIP

FST-951RA-IV: Same as FST-951R-IV but with ULC listing

FST-951H: White, low-profile intelligent 190°F fixed thermal sensor, FlashScan only

FST-951HA: Same as FST-951H but with ULC listing

FST-951H-IV: Ivory, low-profile intelligent 190°F thermal sensor, FlashScan and CLIP

FST-951HA-IV: Same as FST-951 but with ULC listing

INTELLIGENT BASES

NOTE: For details on intelligent bases, see DN-60981.

B300-6: White, 6” base, standard flanged low-profile mounting base (CSFM: 7300-1653:0109)

B300-6-IV: Ivory, 6” base, standard flanged low-profile mounting base (CSFM: 7300-1653:0109)

B300A-6: Same as B300-6, ULC listed

B300A-6-IV: Ivory, 6” standard flanged low-profile mounting base, ULC listed

B300-6-BP: Bulk pack of B300-6, package contains 10

B501-WHITE: White, 4” standard European flangeless mounting base. UL/ULC listed (CSFM: 7300-1653:0109)

B501-BL: Black, 4” standard European flangeless mounting base. UL/ULC listed (CSFM: 7300-1653:0109)

B501-IV: Ivory color, 4” standard European flangeless mounting base. UL/ULC listed (CSFM: 7300-1653:0109)

B501-WHITE-BP: Bulk pack of B501-WHITE contains 10

B224RB-WH: White, relay base (CSFM: 7300-1653:0216)

B224RB-IV: Ivory, relay base (CSFM: 7300-1653:0216)

B224RBA-WH: White, relay base, ULC listing

B224RBA-IV: Ivory, relay base, ULC listing

B224BI-WH: White, isolator detector base (CSFM: 7300-1653:0216)

B224BI-IV: Ivory isolator detector base (CSFM: 7300-1653:0216)

B224BIA-WH: White, isolator detector base, ULC listing

B224BIA-IV: Ivory isolator detector base, ULC listing

B200S-WH: White, Intelligent addressable sounder base capable of producing sound output in high or low volume with ANSI Temporal 3, ANSI Temporal 4, continuous tone, marching tone, and custom tone. Uses FlashScan protocol. (CSFM: 7300-1653:0213)

B200S-IV: Ivory, Intelligent addressable sounder base capable of producing sound output in high or low volume with ANSI Temporal 3, ANSI Temporal 4, continuous tone, marching tone, and custom tone. Uses FlashScan protocol. (CSFM: 7300-1653:0213)

B200SA-WH: Same as B200S-WH, ULC listing

B200SA-IV: Same as B200S-IV, ULC listing

B200SCOA-WH: White, Intelligent, programmable sounder base in English/French (required in Canada for ULC applications with CO Series detector applications)

B200SCOA-IV: Ivory Intelligent, programmable sounder base in English/French (required in Canada for ULC applications with CO Series detector applications, ULC listing)

B200S-LF-WH: White, Low Frequency Intelligent, programmable sounder base. Produces a fundamental frequency of 520 Hz +/- 10% with a square wave or its equivalent; designed to meet the NFPA 72 sleeping space requirement. (CSFM: 7300-1653:0238)

B200S-LF-IV: Ivory, Low Frequency Intelligent, programmable sounder base. Produces a fundamental frequency of 520 Hz +/- 10% with a square wave or its equivalent; designed to meet the NFPA 72 sleeping space requirement. (CSFM: 7300-1653:0238)

B200SR-WH: White, Intelligent sounder base capable of producing sound output with ANSI Temporal 3 or continuous tone. Intended for retrofit applications. (CSFM: 7300-1653:0213)

B200SR-IV: Ivory, Intelligent sounder base capable of producing sound output with ANSI Temporal 3 or continuous tone. Intended for retrofit applications. (CSFM: 7300-1653:0213)

B200SRA-WH: Same as B200SR-WH with, ULC listing

B200SRA-IV: Same as B200SR-IV in Ivory color, ULC listing

B200SR-LF-WH: White, Low Frequency Intelligent, programmable sounder base. Produces a fundamental frequency of 520 Hz +/- 10% with a square wave or its equivalent; designed to meet the NFPA 72 sleeping space requirement. Intended for retrofit applications. (CSFM: 7300-1653:0238)

B200SR-LF-IV: Ivory, Low Frequency Intelligent, programmable sounder base. Produces a fundamental frequency of 520 Hz +/- 10% with a square wave or its equivalent; designed to meet the NFPA 72 sleeping space requirement. Intended for retrofit applications. (CSFM: 7300-1653:0238)

MOUNTING KITS AND ACCESSORIES

TR300: White, replacement flange for B210LP(A) base

TR300-IV: Ivory, replacement flange for B210LP(A) base

RA100Z(A): Remote LED annunciator. 3-32 VDC. Mounts to a U.S. single-gang electrical box. For use with B501(A) and B300-6(A).

M02-04-00: Test magnet

M02-09-00: Test magnet with telescoping handle

CK300: Color Kit (includes cover and trim ring), white, 10-pack

CK300-IV: Color Kit (includes cover and trim ring), ivory, 10-pack

CK300-BL: Color Kit (includes cover and trim ring), black, 10-pack

SPECIFICATIONS

Sensitivity: UL Applications: 0.5% to 4.0% per foot obscuration.
ULC is 0.5% to 3.5%

Size: 2.0" (5.3 cm) high; base determines diameter

- **B300-6:** 6.1" (15.6 cm) diameter
- **B501:** 4" (10.2 cm) diameter

For a complete list of detector bases see DN-60981

Shipping weight: 3.4 oz. (95 g)

Operating temperature range:

- FST-951, FST-951R Series: –4°F to 100°F (–20°C to 38°C)
- FST-951H Series: –4°F to 150°F (–20°C to 66°C)

Detector spacing: UL approved for 50 ft. (15.24 m) center-to-center, FM approved for 25 x 25 ft. (7.62 x 7.62 m) spacing

Relative humidity: 10% – 93% non-condensing

Thermal ratings: fixed-temperature set point 135°F (57°C), rate-of-rise detection 15°F (8.3°C) per minute, high temperature heat 190°F (88°C)

Mounting: B300-6(A) flanged base, included

See “**Product Line Information: Intelligent Bases,**” if using a different base.

ELECTRICAL SPECIFICATIONS

Voltage range: 15 - 32 volts DC peak

Standby current (max. avg.): 200µA @ 24 VDC (one communication every 5 seconds with LED enabled)

Max current: 4.5 mA @ 24 VDC (“ON”)

Listings and Approvals

Listings and approvals below apply to the FST-951 Series detectors. In some cases, certain modules may not be listed by certain approval agencies, or listing may be in process. Consult factory for latest listing status.

- UL/ULC Listing: S747
- FM Approved
- CSFM: 7270-0028:0502



This document is not intended to be used for installation purposes.
We try to keep our product information up-to-date and accurate.
We cannot cover all specific applications or anticipate all requirements.
All specifications are subject to change without notice.

FlashScan® and NOTIFIER® are registered trademarks of Honeywell International, Inc.

©2019 by Honeywell International Inc. All rights reserved. Unauthorized use of this document is strictly prohibited.

Country of Origin: Mexico

NOTIFIER

12 Clintonville Road
Northford, CT 06472
203.484.7161
www.notifier.com



Intelligent Bases Standard, Relay, Isolator, Sounder, and Low-Frequency Sounder Bases

General

Intelligent FlashScan® and CLIP detector mounting bases are available to install NOTIFIER detectors in any application. Bases are available for the new, modern looking aesthetically pleasing 900 series addressable detectors, as well as previous series detectors. Both flanged and flangeless bases are available.

To meet code and specific application requirements **Relay, Isolator and Sounder Bases** versions are available. Relay bases provide one form-C contact for auxiliary functions such as door closure and elevator recall. Isolator bases allow loops to continue to operate under fault conditions and automatically restore when the fault is removed. Sounder bases are available in temporal and non-temporal pattern versions depending on whether the signal is to be used for evacuation purposes. Low frequency sounder bases are UL listed for low frequency operation and comply with NFPA 72 requirements for sleeping spaces.

Specifications

NOTE: Specifications applies to all model variants "A", "-BL", "-LF", "-IV". See Product Line Information for detailed model description.

Diameter

- B501: 4" (10.16 cm) diameter.
- B300-6: 6.1" (15.49 cm) diameter.
- B224RI, B224RB, B210LP: 6.2" (15.748 cm) diameter.
- B200S, B200SR, B200SCOA: 6.875" (17.46 cm) diameter.

Wire gauge:

- B224BI, B224RB: 14 to 24 AWG.
- B300-6, B210LP, B501, B200S, B200SR, B200SCOA: 12 to 24 AWG

Temperature range:

- B224BI, B224RB, B200S, B200SR, B200SCOA: 32°F to 120°F (0°C to 49°C).
- B300-6, B210LP, B501: -4°F to 150°F (-20°C to 66°C).

Humidity range: 10% to 93% RH, non-condensing.

System temperature and humidity ranges: This system meets NFPA requirements for operation at 0°C to 49°C (32°F to 120°F); and at a relative humidity (noncondensing) of 85% at 30°C (86°F) per NFPA, and 93% ± 2% at 32°C ± 2°C (89.6°F ± 1.1°F) per ULC. However, the useful life of the system's standby batteries and the electronic components may be adversely affected by extreme temperature ranges and humidity. Therefore, it is recommended that this system and all peripherals be installed in an environment with a nominal room temperature of 15°C to 27°C (60°F to 80°F).

Electrical Ratings

FOR B200 SERIES BASES:

External supply voltage: 16 to 33 VDC (VFWR)

Standby current:

500 µA maximum.

Alarm current:

- B200S(A)(-IV)
 - 35 mA maximum at high-volume setting.
 - 15 mA maximum at low-volume setting.
- B200S-LF(-IV), High-volume setting:



Flangeless Mounting Base
B501(A)



Flanged Mounting Base
B210LP(A)



Sounder Base
B200S(A), B200SR(A),
B200SCOA



Relay Base
B224RB(A)



Low-Frequency
Sounder
Base B200S-LF,
B200SR-LF



Standard Flanged
Low-Profile Base
B300-6

- 70 mA maximum @ 33.0 VDC.
- 90 mA maximum @ 24.0 VDC.
- 140 mA maximum @ 16.0 VDC.
- B200S-LF(-IV), Low-volume setting:
 - 15 mA maximum @ 33.0 VDC.
 - 20 mA maximum @ 24.0 VDC.
 - 25 mA maximum @ 16.0 VDC.
- B200SR(A)(-IV)
 - 35 mA maximum.
- B200SR-LF(-IV)
 - 65 mA maximum @ 33.0 VDC.
 - 90 mA maximum @ 24.0 VDC.
 - 125 mA maximum @ 16.0 VDC.
- B200SCOA(-IV)
 - 40mA Max. (DC)
 - 70mA Max. (FWR)

SLC operating voltage: 15 to 32 VDC.

SLC standby current: See applicable sensor specification.

Sound output:

- B200S(A)(-LF)(-IV), high-volume*: Greater than 85 dBA minimum.
- B200S(A)(-LF)(-IV), low-volume*: Greater than 75 dBA minimum.
- B200SR(A)(-LF)(-IV)*: Greater than 85 dBA minimum.
- B200SCOA(-IV), high-volume**: Greater than 87 dBA minimum.
- B200SCOA(-IV), low-volume**: Greater than 85 dBA minimum

*Measured in a UL reverberant room at 10 feet, 24 Volts (continuous tone)
**Measured in a ULC anechoic room at 10 feet, 24 Volts continuous tone)

FOR B224BI, B224RB (A) (-IV):

Operating voltage: 15 to 32 VDC (powered by SLC).

Standby ratings: <500 µA maximum @ 24 VDC.

Set time (B224RB(A)(-IV) only): short delay 55 to 90 msec; long delay 6 to 9 seconds.

Reset time (B224RB(A)(-IV) only): 20 msec maximum.

Relay characteristics (B224RB(A)(-IV) only): two-coil latching relay; one Form-C contact; ratings (UL/CSA): 0.9 A @ 125 VAC, 0.9 A @ 110 VDC, and 3.0 A @ 30 VDC.

Product Line Information

INTELLIGENT BASES

NOTE: "A" suffix indicates ULC Listed model.

NOTE: "-IV" suffix indicates Ivory color model.

NOTE: "-BL" suffix indicates Black color model.

B210LP: Flanged mounted base.

B210LPA: Same as B210LP ULC listed.

B210LPBP: Bulk pack of B210LP contains 10.

B300-6: White, 6" base, standard flanged low-profile mounting base. (CSFM: 7300-1653:0109)

B300A-6: Same as B300-6, ULC listed.

B300-6-BP: Bulk pack of B300-6, package contains 10

B300-6-IV: Ivory, 6" base, standard flanged low-profile mounting base. (CSFM: 7300-1653:0109)

B300A-6-IV: Ivory, 6" standard flanged low-profile mounting base, ULC listed.

B501-WHITE: White, 4" standard European flangeless mounting base. UL/ULC listed. (CSFM: 7300-1653:0109)

B501-WHITE-BP: Bulk pack of B501-WHITE contains 10.

B501-BL: Black, 4" standard European flangeless mounting base. UL/ULC listed. (CSFM: 7300-1653:0109)

B501-IV: Ivory color, 4" standard European flangeless mounting base. UL/ULC listed. (CSFM: 7300-1653:0109)

B224RB-WH: White, relay base. (CSFM: 7300-1653:0216)

B224RB-IV: Ivory, relay base. (CSFM: 7300-1653:0216)

B224RBA-WH: White, relay base, ULC listing.

B224RBA-IV: Ivory, relay base, ULC listing.

B224BI-WH: White, *isolator* detector base. (CSFM: 7300-1653:0216)

B224BI-IV: Ivory *isolator* detector base. (CSFM: 7300-1653:0216)

B224BIA-WH: White, *isolator* detector base, ULC listing.

B224BIA-IV: Ivory *isolator* detector base, ULC listing.

B200S-WH: White, Intelligent addressable sounder base capable of producing sound output in high or low volume with ANSI Temporal 3, ANSI Temporal 4, continuous tone, marching tone, and custom tone. Uses FlashScan protocol. (CSFM: 7300-1653:0213)

B200S-IV: Ivory, Intelligent addressable sounder base capable of producing sound output in high or low volume with ANSI Temporal 3, ANSI Temporal 4, continuous tone, marching tone, and custom tone. Uses FlashScan protocol. (CSFM: 7300-1653:0213)

B200SA-WH: Same as B200S-WH, ULC listing.

B200SA-IV: Same as B200S-IV, ULC listing.

B200SCOA-WH: White, Intelligent, programmable sounder base in English/French (required in Canada for ULC applications with SO Series detector applications).

B200SCOA-IV: Ivory Intelligent, programmable sounder base in English/French (required in Canada for ULC applications with SO Series detector applications, ULC listing).

B200S-LF-WH: White, Low Frequency Intelligent, programmable sounder base. Produces a fundamental frequency of 520 Hz +/- 10% with a square wave or its equivalent; designed to meet the NFPA 72 sleeping space requirement. (CSFM: 7300-1653:0238)

B200S-LF-IV: Ivory, Low Frequency Intelligent, programmable sounder base. Produces a fundamental frequency of 520 Hz +/- 10% with a square wave or its equivalent; designed to meet the NFPA 72 sleeping space requirement. (CSFM: 7300-1653:0238)

B200SR-WH: White, Intelligent sounder base capable of producing sound output with ANSI Temporal 3 or continuous tone. Intended for retrofit applications. (CSFM: 7300-1653:0213)

B200SR-IV: Ivory, Intelligent sounder base capable of producing sound output with ANSI Temporal 3 or continuous tone. Intended for retrofit applications. (CSFM: 7300-1653:0213)

B200SRA-WH: Same as B200SR-WH with, ULC listing.

B200SRA-IV: Same as B200SR-IV in Ivory color, ULC listing.

B200SR-LF-WH: White, Low Frequency Intelligent, programmable sounder base. Produces a fundamental frequency of 520 Hz +/- 10% with a square wave or its equivalent; designed to meet the NFPA 72 sleeping space requirement. Intended for retrofit applications. (CSFM: 7300-1653:0238)

B200SR-LF-IV: Ivory, Low Frequency Intelligent, programmable sounder base. Produces a fundamental frequency of 520 Hz +/- 10% with a square wave or its equivalent; designed to meet the NFPA 72 sleeping space requirement. Intended for retrofit applications. (CSFM: 7300-1653:0238)

MOUNTING KITS AND ACCESSORIES

TR300: White, replacement flange for B210LP(A) base.

TR300-IV: Ivory, replacement flange for B210LP(A) base.

RA100Z(A): Remote LED annunciator. 3 – 32 VDC. Mounts to a U.S. single-gang electrical box. For use with B501(A) and B300(A)-6.

M02-04-00: Test magnet.

M02-09-00: Test magnet with telescoping handle.

XR2B: Detector removal tool. Allows installation and/or removal of detector heads from bases in high ceiling applications.

XP-4: Extension pole for XR2B. Comes in three 5-foot (1.524m) sections.

T55-127-010: Detector removal tool without pole.

CK300: White, detector color kit. Pack of 10.

CK300-IR: White, detector color kit for use with FPTI and FCO Series detectors. Pack of 10.

CK300-IV: Ivory, detector color kit. Pack of 10.

CK300-IR-IV: Ivory, detector color kit for use with FPTI and FCO Series detectors. Pack of 10.

CK300-BL: Black, detector color kit. Pack of 10.

CK300-IR-BL: Black, detector color kit for use with FPTI and FCO Series detectors. Pack of 10.

Agency Listings and Approvals

The listings and approvals below apply to intelligent bases as noted. In some cases, certain modules or applications may not be listed by certain approval agencies, or listing may be in process. Consult factory for latest listing status.

- **UL Listed:** S911, S1115
- **ULC Listed:** S911, S1115.
- **FM Approved.**
- **MEA:** 22-95-E, 205-94-E Vol. 2; 257-06-E
- **CSFM:** 7270-0028-0502, 7272-0028:0503, 7300-1653:0126, 7135-1653:0213, 7300-1653:0109

Junction Box Selection Guide

Base Models	Single Gang	3.5" Oct.	4.0" Oct.	4.0" Sq.	4.0" Sq. with 3.0" mud ring	50 mm	60 mm	70 mm	75 mm
B200S, B200SR, B200SCOA	Yes	Yes	Yes	Yes	Yes	No	No	No	No
B501	No	Yes	No	No	Yes	Yes	Yes	Yes	No
B210LP	Yes	Yes	Yes	Yes	Yes	No	No	No	No
B224RB	No	Yes	Yes	Yes	No	No	Yes	Yes	Yes
B224BI	No	Yes	Yes	Yes	No	No	No	Yes	Yes

NOTE: Box depth contingent on base and wire size.
Refer to National Electric Code or applicable local codes for appropriate recommendations.

NOTE: Applies to all model variants "A", "-BL", "-LF", "-IV". See Product Line Information for detailed model description.



This document is not intended to be used for installation purposes.
We try to keep our product information up-to-date and accurate.
We cannot cover all specific applications or anticipate all requirements.
All specifications are subject to change without notice.

FlashScan®, NOTIFIER® and System Sensor® are registered trademarks of Honeywell International Inc.
©2018 by Honeywell International Inc. All rights reserved.
Unauthorized use of this document is strictly prohibited.

Country of Origin: USA

NOTIFIER
12 Clintonville Road
Northford, CT 06472
203.484.7161
www.notifier.com



FCM-1(A) & FRM-1(A) Series

Control and Relay Modules



Intelligent / Addressable Devices

General

FCM-1(A) Control Module: The FCM-1(A) Addressable Control Module provides Notifier intelligent fire alarm control panels a circuit for Notification Appliances (horns, strobes, speakers, etc.). Addressability allows the FCM-1(A) to be activated, either manually or through panel programming, on a select (zone or area of coverage) basis.

FRM-1(A) Relay Module: The FRM-1(A) Addressable Relay Module provides the system with a dry-contact output for activating a variety of auxiliary devices, such as fans, dampers, control equipment, etc. Addressability allows the dry contact to be activated, either manually or through panel programming, on a select basis.

FlashScan® (U.S. Patent 5,539,389) is a communication protocol developed by NOTIFIER Engineering that greatly enhances the speed of communication between analog intelligent devices. Intelligent devices communicate in a grouped fashion. If one of the devices within the group has new information, the panel CPU stops the group poll and concentrates on single points. The net effect is response speed greater than five times that of other designs.



FCM-1(A)

Features

- Built-in type identification automatically identifies these devices to the control panel.
- Internal circuitry and relay powered directly by two-wire SLC loop. The FCM-1(A) module requires power (for horns, strobes, etc.), or audio (for speakers).
- Integral LED “blinks” green each time a communication is received from the control panel and turns on in steady red when activated.
- LED blink may be deselected globally (affects all devices).
- High noise immunity (EMF/RFI).
- The FCM-1(A) may be used to switch 24-volt NAC power, audio (up to 70.7 Vrms).
- Wide viewing angle of LED.
- SEMS screws with clamping plates for wiring ease.
- Direct-dial entry of address 01– 159 for FlashScan loops, 01 – 99 for CLIP mode loops.
- Speaker, and audible/visual applications may be wired for Class B or A (Style Y or Z).

Applications

The FCM-1(A) is used to switch 24 VDC audible/visual power, high-level audio (speakers). The FRM-1(A) may be programmed to operate dry contacts for applications such as door holders or Air Handling Unit shutdown, and to reset four-wire smoke detector power.

NOTE: Refer to the SLC Manual (PN 51253) for details regarding releasing applications with the FCM-1(A). Refer to the FCM-1-REL datasheet (DN-60390) for new FlashScan® releasing applications.

Construction

- The face plate is made of off-white heat-resistant plastic.
- Controls include two rotary switches for direct-dial entry of address (01-159).

- The FCM-1(A) is configured for a single Class B (Style Y) or Class A (Style Z) Notification Appliance Circuit.
- The FRM-1(A) provides two Form-C dry contacts that switch together.

Operation

Each FCM-1(A) or FRM-1(A) uses one of 159 possible module addresses on a SLC loop (99 on CLIP loops). It responds to regular polls from the control panel and reports its type and status, including the open/normal/short status of its Notification Appliance Circuit (NAC). The LED blinks with each poll received. On command, it activates its internal relay. The FCM-1(A) supervises Class B (Style Y) or Class A (Style Z) notification or control circuits.

Upon code command from the panel, the FCM-1(A) will disconnect the supervision and connect the external power supply in the proper polarity across the load device. The disconnection of the supervision provides a positive indication to the panel that the control relay actually turned ON. The external power supply is always relay isolated from the communication loop so that a trouble condition on the external power supply will never interfere with the rest of the system.

Rotary switches set a unique address for each module. The address may be set before or after mounting. The built-in TYPE CODE (not settable) will identify the module to the control panel, so as to differentiate between a module and a sensor address.

Specifications for FCM-1(A)

Normal operating voltage: 15 to 32 VDC.

Maximum current draw: 6.5 mA (LED on).

Average operating current: 350 μ A direct poll, 375 μ A group poll with LED flashing, 485 μ A Max. (LED flashing, NAC shorted.)

Maximum NAC Line Loss: 4 VDC.

External supply voltage (between Terminals T10 and T11): Maximum (NAC): Regulated 24 VDC; Maximum (Speakers): 70.7 V RMS, 50W.

Drain on external supply: 1.7 mA maximum using 24 VDC supply; 2.2 mA Maximum using 80 VRMS supply.

Max NAC Current Ratings: For class B wiring system, the current rating is 3A; For class A wiring system, the current rating is 2A.

Temperature range: 32°F to 120°F (0°C to 49°C).

Humidity range: 10% to 93% non-condensing.

Dimensions: 4.5" (114.3 mm) high x 4" (101.6 mm) wide x 1.25" (31.75 mm) deep. Mounts to a 4" (101.6 mm) square x 2.125" (53.975 mm) deep box.

Accessories: SMB500 Electrical Box; CB500 Barrier

Specifications for FRM-1(A)

Normal operating voltage: 15 to 32 VDC.

Maximum current draw: 6.5 mA (LED on).

Average operating current: 230 µA direct poll; 255 µA group poll.

EOL resistance: not used.

Temperature range: 32°F to 120°F (0°C to 49°C).

Humidity range: 10% to 93% non-condensing.

Dimensions: 4.5" (114.3 mm) high x 4" (101.6 mm) wide x 1.25" (31.75 mm) deep. Mounts to a 4" (101.6 mm) square x 2.125" (53.975 mm) deep box.

Accessories: SMB500 Electrical Box; CB500 Barrier

Agency Listings and Approvals

In some cases, certain modules may not be listed by certain approval agencies, or listing may be in process. Consult factory for latest listing status.

- **UL:** S635
- **ULC:** S3705 (A version only)
- **FM Approved**
- **CSFM:** 7300-0028:0219
- **MEA:** 14-00-E
- **FDNY:** COA #6067, #6065

Contact Ratings for FRM-1(A)

Current Rating	Maximum Voltage	Load Description	Application
3 A	30 VDC	Resistive	Non-Coded
2 A	30 VDC	Resistive	Coded
.9 A	110 VDC	Resistive	Non-Coded
.9 A	125 VDC	Resistive	Non-Coded
.5 A	30 VDC	Inductive (L/R=5ms)	Coded
1 A	30 VDC	Inductive (L/R=2ms)	Coded
.3 A	125 VAC	Inductive (PF=0.35)	Non-Coded
1.5 A	25 VAC	Inductive (PF=0.35)	Non-Coded
.7 A	70.7 VAC	Inductive (PF=0.35)	Non-Coded
2 A	25 VAC	Inductive (PF=0.35)	Non-Coded

NOTE: Maximum (Speakers): 70.7 V RMS, 50 W

Product Line Information

NOTE: "A" suffix indicates ULC Listed model.

FCM-1(A): Intelligent Addressable Control Module.

FRM-1(A): Intelligent Addressable Relay Module.

A2143-20: Capacitor, required for Class A (Style Z) operation of speakers.

SMB500: Optional Surface-Mount Backbox.

CB500: Control Module Barrier — required by UL for separating power-limited and non-power limited wiring in the same junction box as FCM-1(A).

NOTE: For installation instructions, see the following documents:

- *FCM-1(A) Installation document I56-1169.*
- *FRM-1(A) Installation document I56-3502.*
- *Notifier SLC Wiring Manual, document 51253.*

Notifier® and FlashScan® are registered trademarks of Honeywell International Inc.

©2011 by Honeywell International Inc. All rights reserved. Unauthorized use of this document is strictly prohibited.



This document is not intended to be used for installation purposes.
We try to keep our product information up-to-date and accurate.
We cannot cover all specific applications or anticipate all requirements.
All specifications are subject to change without notice.



Made in the U.S. A.

For more information, contact Notifier. Phone: (203) 484-7161, FAX: (203) 484-7118.
www.notifier.com

FMM-1(A), FMM-101(A), FZM-1(A) & FDM-1(A)

Monitor Modules with FlashScan®



Intelligent/Addressable Devices

General

Four different monitor modules are available for Notifier's intelligent control panels for a variety of applications. Monitor modules supervise a circuit of dry-contact input devices, such as conventional heat detectors and pull stations, or monitor and power a circuit of two-wire smoke detectors (FZM-1(A)).

FMM-1(A) is a standard-sized module (typically mounts to a 4" [10.16 cm] square box) that supervises either a Style D (Class A) or Style B (Class B) circuit of dry-contact input devices.

FMM-101(A) is a miniature monitor module a mere 1.3" (3.302 cm) H x 2.75" (6.985 cm) W x 0.65" (1.651 cm) D that supervises a Style B (Class B) circuit of dry-contact input devices. Its compact design allows the FMM-101(A) to be mounted in a single-gang box behind the device it monitors.

FZM-1(A) is a standard-sized module that monitors and supervises compatible two-wire, 24 volt, smoke detectors on a Style D (Class A) or Style B (Class B) circuit.

FDM-1(A) is a standard-sized dual monitor module that monitors and supervises two independent two-wire Style B (Class B) dry-contact initiating device circuits (IDCs) at two separate, consecutive addresses in intelligent, two-wire systems.

FlashScan® (U.S. Patent 5,539,389) is a communication protocol developed by NOTIFIER that greatly increases the speed of communication between analog intelligent devices. Intelligent devices communicate in a grouped fashion. If one of the devices within the group has new information, the panel CPU stops the group poll and concentrates on single points. The net effect is response speed greater than five times that of other communication protocols.

FMM-1(A) Monitor Module

- Built-in type identification automatically identifies this device as a monitor module to the control panel.
- Powered directly by two-wire SLC loop. No additional power required.
- High noise (EMF/RFI) immunity.
- SEMS screws with clamping plates for ease of wiring.
- Direct-dial entry of address: 01 – 159 on FlashScan loops; 01 – 99 on CLIP loops.
- LED flashes green during normal operation (programmable option) and latches on steady red to indicate alarm.

The FMM-1(A) Monitor Module is intended for use in intelligent, two-wire systems, where the individual address of each module is selected using the built-in rotary switches. It provides either a two-wire or four-wire fault-tolerant Initiating Device Circuit (IDC) for normally-open-contact fire alarm and supervisory devices. The module has a panel-controlled LED indicator. The FMM-1(A) can be used to replace MMX-1(A) modules in existing systems.

FMM-1(A) APPLICATIONS

Use to monitor a zone of four-wire smoke detectors, manual fire alarm pull stations, waterflow devices, or other normally-

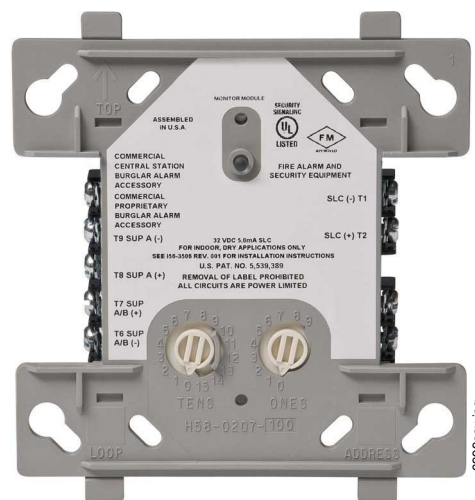

FMM-1(A) (Type H)

open dry-contact alarm activation devices. May also be used to monitor normally-open supervisory devices with special supervisory indication at the control panel. Monitored circuit may be wired as an NFPA Style B (Class B) or Style D (Class A) Initiating Device Circuit. A 47K Ohm End-of-Line Resistor (provided) terminates the Style B circuit. No resistor is required for supervision of the Style D circuit.

FMM-1(A) OPERATION

Each FMM-1(A) uses one of the available module addresses on an SLC loop. It responds to regular polls from the control panel and reports its type and the status (open/normal/short) of its Initiating Device Circuit (IDC). A flashing LED indicates that the module is in communication with the control panel. The LED latches steady on alarm (subject to current limitations on the loop).

FMM-1(A) SPECIFICATIONS

Nominal operating voltage: 15 to 32 VDC.

Maximum current draw: 5.0 mA (LED on).

Average operating current: 375 µA (LED flashing), 1 communication every 5 seconds, 47k EOL.

Maximum IDC wiring resistance: 1500 Ohms.

Maximum IDC Voltage: 11 Volts.

EOL resistance: 47K Ohms.

Temperature range: 32°F to 120°F (0°C to 49°C).

Humidity range: 10% to 93% noncondensing.

Dimensions: 4.5" (11.43 cm) high x 4" (10.16 cm) wide x 1.25" (3.175 cm) deep. Mounts to a 4" (10.16 cm) square x 2.125" (5.398 cm) deep box.

FMM-101(A) Mini Monitor Module

- Built-in type identification automatically identifies this device as a monitor module to the panel.
- Powered directly by two-wire SLC loop. No additional power required.
- High noise (EMF/RFI) immunity.
- Tinned, stripped leads for ease of wiring.
- Direct-dial entry of address: 01 – 159 on FlashScan loops; 01 – 99 on CLIP loops.

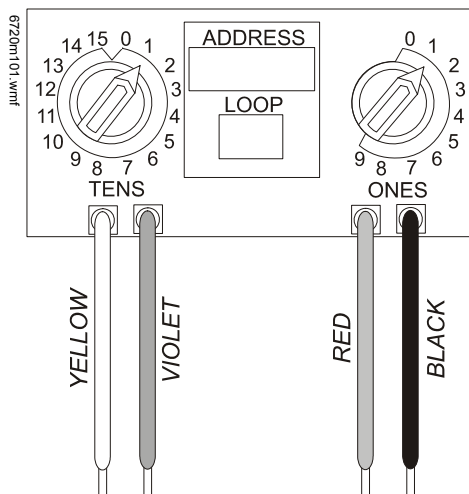

The FMM-101(A) Mini Monitor Module can be installed in a single-gang junction directly behind the monitored unit. Its small size and light weight allow it to be installed without rigid mounting. The FMM-101(A) is intended for use in intelligent, two-wire systems where the individual address of each module is selected using rotary switches. It provides a two-wire initiating device circuit for normally-open-contact fire alarm and security devices. The FMM-101(A) can be used to replace MMX-101(A) modules in existing systems.

FMM-101(A) APPLICATIONS

Use to monitor a single device or a zone of four-wire smoke detectors, manual fire alarm pull stations, waterflow devices, or other normally-open dry-contact devices. May also be used to monitor normally-open supervisory devices with special supervisory indication at the control panel. Monitored circuit/device is wired as an NFPA Style B (Class B) Initiating Device Circuit. A 47K Ohm End-of-Line Resistor (provided) terminates the circuit.

FMM-101(A) OPERATION

Each FMM-101(A) uses one of the available module addresses on an SLC loop. It responds to regular polls from the control panel and reports its type and the status (open/normal/short) of its Initiating Device Circuit (IDC).

FMM-101(A) SPECIFICATIONS

Nominal operating voltage: 15 to 32 VDC.

Average operating current: 350 μ A, 1 communication every 5 seconds, 47k EOL; 600 μ A Max. (Communicating, IDC Shorted).

Maximum IDC wiring resistance: 1500 Ohms.

Maximum IDC Voltage: 11 Volts.

Maximum IDC Current: 450 μ A.

EOL resistance: 47K Ohms.

Temperature range: 32°F to 120°F (0°C to 49°C).

Humidity range: 10% to 93% noncondensing.

Dimensions: 1.3" (3.302 cm) high x 2.75" (6.985 cm) wide x 0.65" (1.651 cm) deep.

Wire length: 6" (15.24 cm) minimum.

FZM-1(A) Interface Module

- Supports compatible two-wire smoke detectors.
- Supervises IDC wiring and connection of external power source.
- High noise (EMF/RFI) immunity.
- SEMS screws with clamping plates for ease of wiring.
- Direct-dial entry entry of address: 01 – 159 on FlashScan loops, 01 – 99 on CLIP loops.
- LED flashes during normal operation; this is a programmable option.
- LED latches steady to indicate alarm on command from control panel.

The FZM-1(A) Interface Module is intended for use in intelligent, addressable systems, where the individual address of each module is selected using built-in rotary switches. This module allows intelligent panels to interface and monitor two-wire conventional smoke detectors. It transmits the status (normal, open, or alarm) of one full zone of conventional detectors back to the control panel. All two-wire detectors being monitored must be UL compatible with the module. The FZM-1(A) can be used to replace MMX-2(A) modules in existing systems.

FZM-1(A) APPLICATIONS

Use the FZM-1(A) to monitor a zone of two-wire smoke detectors. The monitored circuit may be wired as an NFPA Style B (Class B) or Style D (Class A) Initiating Device Circuit. A 3.9 K Ohm End-of-Line Resistor (provided) terminates the end of the Style B or D (class B or A) circuit (maximum IDC loop resistance is 25 Ohms). Install ELR across terminals 8 and 9 for Style D application.

FZM-1(A) OPERATION

Each FZM-1(A) uses one of the available module addresses on an SLC loop. It responds to regular polls from the control panel and reports its type and the status (open/normal/short) of its Initiating Device Circuit (IDC). A flashing LED indicates that the module is in communication with the control panel. The LED latches steady on alarm (subject to current limitations on the loop).

FZM-1(A) SPECIFICATIONS

Nominal operating voltage: 15 to 32 VDC.

Maximum current draw: 5.1 mA (LED on).

Maximum IDC wiring resistance: 25 Ohms.

Average operating current: 270 μ A, 1 communication and 1 LED flash every 5 seconds, 3.9k eol.

EOL resistance: 3.9K Ohms.

External supply voltage (between Terminals T10 and T11):

- DC voltage: 24 volts power limited.
- Ripple voltage: 0.1 Vrms maximum.
- Current: 90 mA per module maximum.

Temperature range: 32°F to 120°F (0°C to 49°C).

Humidity range: 10% to 93% noncondensing.

Dimensions: 4.5" (11.43 cm) high x 4" (10.16 cm) wide x 1.25" (3.175 cm) deep. Mounts to a 4" (10.16 cm) square x 2.125" (5.398 cm) deep box.

FDM-1(A) Dual Monitor Module

The FDM-1(A) Dual Monitor Module is intended for use in intelligent, two-wire systems. It provides two independent two-wire initiating device circuits (IDCs) at two separate, consecutive addresses. It is capable of monitoring normally open contact fire alarm and supervisory devices; or either normally open or normally closed security devices. The module has a single panel-controlled LED.

NOTE: The FDM-1(A) provides two Style B (Class B) IDC circuits ONLY. Style D (Class A) IDC circuits are NOT supported in any application.

FDM-1(A) SPECIFICATIONS

Normal operating voltage range: 15 to 32 VDC.

Maximum current draw: 6.4 mA (LED on).

Average operating current: 750 μ A (LED flashing).

Maximum IDC wiring resistance: 1,500 Ohms.

Maximum IDC Voltage: 11 Volts.

Maximum IDC Current: 240 μ A

EOL resistance: 47K Ohms.

Temperature range: 32° to 120°F (0° to 49°C).

Humidity range: 10% to 93% (non-condensing).

Dimensions: 4.5" (11.43 cm) high x 4" (10.16 cm) wide x 1.25" (3.175 cm) deep. Mounts to a 4" (10.16 cm) square x 2.125" (5.398 cm) deep box.

FDM-1(A) AUTOMATIC ADDRESSING

The FDM-1(A) automatically assigns itself to two addressable points, starting with the original address. For example, if the FDM-1(A) is set to address "26", then it will automatically assign itself to addresses "26" and "27".

NOTE: "Ones" addresses on the FDM-1(A) are 0, 2, 4, 6, or 8 only. Terminals 6 and 7 use the first address, and terminals 8 and 9 use the second address.



CAUTION:

Avoid duplicating addresses on the system.

Installation

FMM-1(A), FZM-1(A), and FDM-1(A) modules mount directly to a standard 4" (10.16 cm) square, 2.125" (5.398 cm) deep, electrical box. They may also be mounted to the SMB500 surface-mount box. Mounting hardware and installation instructions are provided with each module. All wiring must conform to applicable local codes, ordinances, and regulations. These modules are intended for power-limited wiring only.

The FMM-101(A) module is intended to be wired and mounted without rigid connections inside a standard electrical box. All wiring must conform to applicable local codes, ordinances, and regulations.

Agency Listings and Approvals

In some cases, certain modules may not be listed by certain approval agencies, or listing may be in process. Consult factory for latest listing status.

- **UL:** S635.
- **ULC:** S635.
- **FM Approved.**
- **CSFM:** 7300-0028:0219, 7165-0028:0224, 7165-0028:0243.
- **MEA:** 457-99-E.
- **U.S. Coast Guard:** 161.002/50/0 (NFS2-640, NFS2-320, NFS2-3030).
- **Lloyd's Register:** 11/600013 (NFS2-640, NFS2-320, NFS2-3030).
- **Fire Dept. of New York:** COA #6121 (NFS2-640, NFS-320), COA# 6114 (NFS2-3030).

Product Line Information

NOTE: "A" suffix indicates ULC-listed model.

FMM-1(A): Monitor module.

FMM-101(A): Monitor module, miniature.

FZM-1(A): Monitor module, two-wire detectors.

FDM-1(A): Monitor module, dual, two independent Class B circuits.

SMB500: Optional surface-mount backbox.

NOTE: See installation instructions and refer to the SLC Wiring Manual, PN 51253.

FlashScan® and NOTIFIER® are registered trademarks and FireWatch™ is a trademark of Honeywell International Inc.
©2015 by Honeywell International Inc. All rights reserved. Unauthorized use of this document is strictly prohibited.



This document is not intended to be used for installation purposes.
We try to keep our product information up-to-date and accurate.
We cannot cover all specific applications or anticipate all requirements.
All specifications are subject to change without notice.

For more information, contact Notifier. Phone: (203) 484-7161, FAX: (203) 484-7118.
www.notifier.com

Duct Smoke Detector Accessories

for Notifier/System Sensor Products



Miscellaneous

General

Duct smoke detector accessories add functionality to the duct smoke system by allowing quick, convenient inspections at eye level and effective audible and visual notification options. All System Sensor duct smoke detectors and accessories are UL listed.

Specifications

APA151 PIEZO ANNUNCIATOR

The **APA151** piezo annunciator, which replaces the APA451 with a new, improved look, provides an audible alarm signal, a red LED to indicate alarm status, and a green LED to indicate power status. It is intended for use with System Sensor 4-wire conventional duct smoke detector applications without a system control panel, to comply with NFPA 90A.



APA151.wmf

APA151 Piezo Annunciator	
Voltage	Regulated 24 VDC
Operating Voltage	16 to 33 VDC
Maximum Alarm Current	30 mA
Temperature Range	32°F to 120°F (0°C to 49°C)
Relative Humidity	10 to 93%, non-condensing
Wire Gauge	12 to 18 AWG
Dimensions	4.6" H x 2.9" W x .45" D

MHR/MHW MINI-HORNS

The **MHR** and **MHW** SpectrAlert® Advance mini-horns feature temporal or continuous tones at high and low volume settings. Their small footprint allows mounting to single-gang back boxes for applications where a small device is desired.



MHR.wmf, MHW.wmf



60535cov.wmf

MHR/MHW SpectrAlert Advance Mini-Horns	
Voltage	Regulated 12 DC or FWR (Full Wave Rectified) or Regulated 24 VDC or FWR
Operating Voltage	8 to 33 VDC (9 to 33 VDC with Sync-Circuit™ Module)
Sounder Current Draw	22 mA RMS max. at 8 to 17.5 Volts DC 17 mA RMS max. at 8 to 17.5 Volts FWR 29 mA RMS max. at 16 to 33 Volts DC 25 mA RMS max. at 16 to 33 Volts FWR
Temperature Range	32°F to 120°F (0°C to 49°C)
Humidity Range	10 to 93% non-condensing
Nominal Sounder Frequency	3 kHz
Wire Gauge	12 to 18 AWG
Dimensions	4.6"H x 2.9"W x 0.45"D

RA100Z/RA100ZA REMOTE ANNUNCIATORS

The **RA100Z** and **RA100ZA** remote annunciators are designed for both conventional and intelligent applications. Their red LED provides visual indication of an alarm condition.



RA100Z.wmf

RA100Z/RA100ZA Remote Annunciator	
Voltage Range	Conventional System: 3.1 to 32 VDC Intelligent System: 18 to 32 VDC
Maximum Alarm Current	10 mA
Dimensions	4.6"H x 2.8"W x 1.3"D

RTS151/RTS151KEY REMOTE TEST STATIONS

The **RTS151** and **RTS151KEY** remote test stations are automatic fire detector accessories designed to test duct smoke detectors from a convenient location. For 4-wire detectors, the **RTS151KEY** test station features a multi-colored LED that alternates between steady green and red. For 2-wire detectors, the LED illuminates red for alarm.



RTS151.wmf, RTS151KEY.wmf

RTS151 Remote Test Station	
Power Requirements	Alarm LED 2.8 to 32 VDC, 10 mA max. Total Current: 95 mA max.
Test Switch	10 VA @ 32 VDC
Reset Switch	10 VA @ 32 VDC
Alarm Response Time	40 seconds max.
Temperature Range	14°F to 140°F (-10°C to 60°C)
Relative Humidity	95% non-condensing
Wire Gauge	14 to 18 AWG
Dimensions	4.8"H x 2.9W x 1.4"D

RTS151KEY Remote Test Station with Key

Power Requirements	Power LED (Green): 14 to 35 VDC, 12 mA max. Alarm LED (RED): 2.8 to 32 VDC, 12 mA max.
Alarm Response Time	40 seconds max.
Temperature Range	14°F to 140°F (-10°C to 60°C)
Relative Humidity	95% non-condensing
Wire Gauge	14 to 18 AWG
Dimensions	4.6"H x 2.75W x 1.8"D

RTS2/RTS-AOS MULTI-SIGNALLING ACCESSORIES

The **RTS2** and **RTS2-AOS** multi-signaling accessories are designed to work with InnovairFlex 4-wire conventional duct smoke detectors. These accessories include a key switch that can be used to select one of two connected sensors to be tested, reset, or both by a push button switch. They also enable sensitivity measurements using the SENS-RDR sensitivity reader (sold separately). The **AOS** (Add-On Strobe) is an optional accessory included with the **RTS2-AOS** model.



RTS-AOS.wmf, AOS.wmf

RTS2 and RTS-AOS Multi-Signaling Accessory

Voltage	20 to 29 VDC
Power Requirements	Standby: 3.0 mA max. Trouble: 16.0 mA max. Alarm without Strobe: 30 mA max. Alarm with Strobe: 55 mA max.
Sounder	85 dBA at 10 ft.
Temperature Range	14°F to 140°F (-10°C to 60°C)
Relative Humidity	95% non-condensing
Wire Gauge	14 to 22 AWG
Dimensions	4.8"W x 5.3"H x 1.6"D

Product Line Information

APA151: Piezo Annunciator

MHR: Mini-Horn, Red

MHW: Mini-Horn, White

RA100Z/RA100ZA: Remote Annunciator

RTS151: Remote Test Station

RTS151KEY: Remote Test Station with Key

RTS2: Multi-signaling Accessory

AOS: Add-On Strobe

RTS2-AOS: Multi-Signaling Accessory

Temperature and Humidity Ranges

This system meets NFPA requirements for operation at 0 – 49°C/32 – 120°F and at a relative humidity 93% ± 2% RH (noncondensing) at 32°C ± 2°C (90°F ± 3°F). However, the useful life of the system's standby batteries and the electronic components may be adversely affected by extreme temperature ranges and humidity. Therefore, it is recommended that this system and its peripherals be installed in an environment with a normal room temperature of 15 – 27°C/60 – 80°F.

Agency Listings and Approvals

The listings and approvals below apply to the basic products. In some cases, certain modules may not be listed by certain approval agencies, or listing may be in process. Consult factory for latest listing status.

- **UL: S4011 (APA 151, MHR, MHW), S2522 (RTS2, RA100Z, RTS151, RTS151KEY, RTS2-AOS)**
- **FM Approved**
- **CSFM: 7135-1653:0212**

FlashScan®, **NOTIFIER®** and **System Sensor®** are registered trademarks of Honeywell International Inc.
©2012 by Honeywell International Inc. All rights reserved. Unauthorized use of this document is strictly prohibited.



This document is not intended to be used for installation purposes.
We try to keep our product information up-to-date and accurate.
We cannot cover all specific applications or anticipate all requirements.
All specifications are subject to change without notice.

For more information, contact Notifier. Phone: (203) 484-7161, FAX: (203) 484-7118.
www.notifier.com



Made in the U.S. A.



L-Series and L-Series with LED Indoor Selectable Horns, Strobes and Horn Strobes

System Sensor L-Series and L-Series with LED audible visible notification products are rich with features guaranteed to cut installation times and maximize profits with lower current draw and modern aesthetics.



Features

- LED technology provides lower current draw
- Digital Voltage Meter (DVM) diagnostic test points for Horn Strobes and Strobes
- Common aesthetics across the L-Series platform
- Standard and compact sizes
- Tamper-resistant construction
- Field-selectable candela settings on wall units: 15, 30, 75, 95, 110, 135, and 185
- Field-selectable candela settings on ceiling units: 15, 30, 75, 95, 115, 150, and 177
- Rotary switches for candela, tone and volume selections
- Mounting plate provides plug-in design for easier installation and shorting springs to check wiring continuity
- Electrically compatible with legacy SpectrAlert, SpectrAlert Advance and L-series devices
- Synchronization through use of UL approved power supplies that support System Sensor Sync protocol or System Sensor MDL3 Sync Module
- Horns, Strobes and Horn Strobes listed for wall or ceiling use

The System Sensor L-Series and L-Series with LED platform

offers the most versatile and easy-to-use line of horns, strobes, and horn strobes in the industry with lower current draw and modern aesthetics. LED lighting technology offers significantly lower current draw compared to older Xenon bulbs across a full candela range. This improves design flexibility for notification appliance circuits (NACs) while also reducing power supply requirements allowing for simpler and lower cost installations.

Flexible design options meet virtually any application requirement: wall or ceiling mount, standard or compact sizes, red or white color choices, bezel kits for alternate markings and languages, and LED color lenses for distinctive visual signaling. In addition, installers can easily adapt devices using field selectable candela, tone and volume settings using rotary switches.

The L-Series and L-Series with LED line is developed to simplify installation. All devices feature plug-in designs with minimal intrusion into the back box, making installations fast and foolproof while virtually eliminating costly and time-consuming ground faults. The universal mounting plate includes an onboard shorting spring, so installers can test wiring continuity before the device is installed.

In addition, the System Sensor L-Series with LED notification appliances offer a new diagnostic test point feature that allows you to measure device voltage with a digital voltage meter (DVM) without removing the appliance from the wall or ceiling. The DVM test points are discreetly located on the face of the notification appliance which enable faster troubleshooting and end of line (EOL) voltage checks while greatly reducing the risk of misplacing or damaging appliances during troubleshooting.

Agency Listings

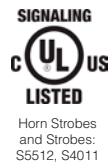

L-Series and L-Series with LED Specifications

Physical/Electrical Specifications	
Standard Operating Temperature	32°F to 120°F (0°C to 49°C)
Humidity Range	10 to 93% non-condensing
Strobe Flash Rate	1 flash per second
Nominal Voltage, LED Strobes and Horn Strobes	Regulated 24 VDC
Nominal Voltage, Horns	Regulated 12 VDC or regulated 24 DC/FWR
Operating Voltage Range, LED Strobes and Horn Strobes	16 to 33 V (24 V nominal)
Operating Voltage Range, Horns	8 to 17.5 V (12 V nominal) or 16 to 33 V (24 V nominal)
Input Terminal Wire Gauge	12 to 18 AWG

UL/ULC Current Draw Data, Horn Tones, and Sound Output Data

UL/ULC Maximum Strobe Current Draw (mA)			
Candela Rating	16-33 Volts		
	Wall	Wall	Ceiling
Candela Range	15	18	18
	30	22	22
	75	70	70
	95	75	75
	110	85	—
	115	—	90
	135	105	—
	150	—	110
	177	—	115
	185	120	—

UL/ULC Maximum Horn Current Draw (mA RMS)					
Sound Pattern	dB	8-17.5 Volts			16-33 Volts
		DC	DC	FWR	DC
Temporal	High	39	44	54	54
Temporal	Low	28	32	54	54
Non-Temporal	High	43	47	54	54
Non-Temporal	Low	29	32	54	54
3.1 KHz Temporal	High	39	41	54	54
3.1 KHz Temporal	Low	29	32	54	54
3.1 KHz Non-Temporal	High	42	43	54	54
3.1 KHz Non-Temporal	Low	28	29	54	54
Coded	High	43	47	54	54
3.1 KHz Coded	High	42	43	54	54

UL/ULC Maximum Horn Strobe Current Draw (mA) and Sound Output (dBA)														
Switch Pos.	Sound Pattern	Volume Setting	Current Draw (mA RMS), Horn Strobe, Candela Range (15-185 cd)										Sound Output (dBA)	
			16-33 Volts											16-33V DC
			15cd	30cd	75cd	95cd	110cd WALL	115cd CEILING	135cd WALL	150cd CEILING	177cd CEILING	185cd WALL		
1	Temporal 3	High	35	38	87	92	94	120	189	189	190	190	87	
2	Temporal 3	Low	35	38	87	92	94	120	135	135	145	145	79	
3	Non-Temporal	High	50	52	87	92	94	120	127	127	135	135	87	
4	Non-Temporal	Low	35	38	87	92	94	120	125	125	130	130	79	
5	3.1KHz Temporal 3	High	35	38	87	89	91	115	155	155	165	165	86	
6	3.1KHz Temporal 3	Low	35	38	87	89	91	115	128	130	135	135	80	
7	3.1KHz Non-Temporal	High	40	42	87	89	91	115	125	125	135	135	86	
8	3.1KHz Non-Temporal	Low	35	38	87	89	91	115	120	120	130	130	80	

L-Series with LED Dimensions: Wall-Mounted Equipment

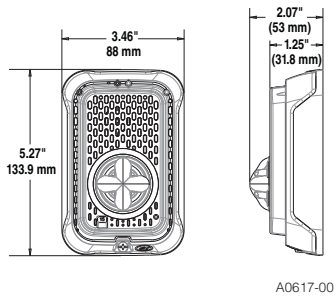

A0617-00

**Compact Strobe, Horn Strobe
for Wall**

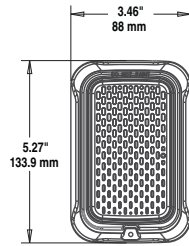

A0547-00

Compact Horn

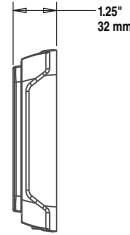

A0557-00

**Compact Surface Mount Back Box
for Walls (SBBGRL, SBBGWL)**

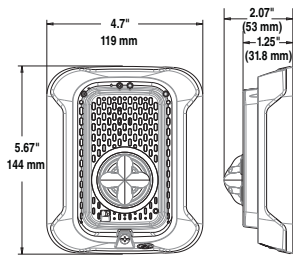
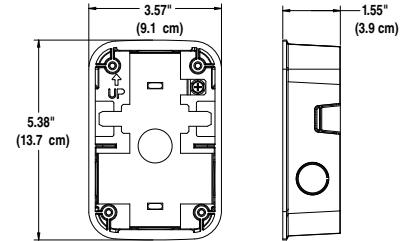

A0613-00

**Strobes, Horn Strobes
for Walls**

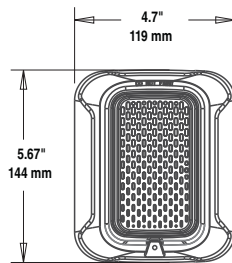

A0549-00

Horn

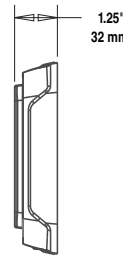

A0554-01

**Surface Mount Back Box
for Walls (SBBRL/SBBWL)**

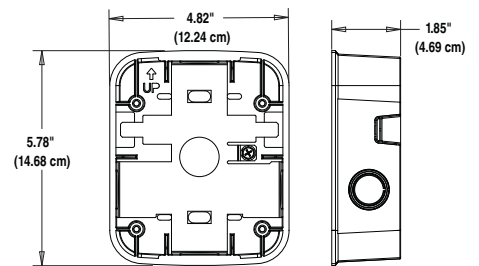

L-Series with LED Dimensions: Ceiling-Mounted Equipment

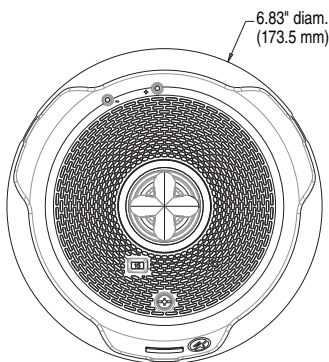

A0608-00

**Strobes and Horn Strobes
for Ceilings**

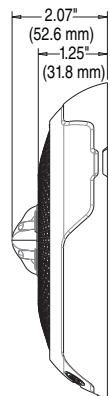

6.92" diam.
(175.77 mm)

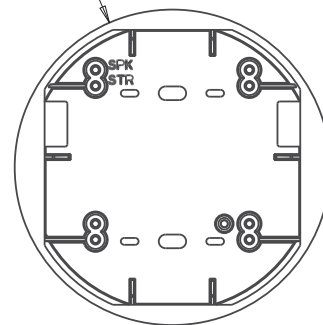

A0546-00

**Surface Mount Back Box
for Ceilings (SBBCRL, SBCWL)**

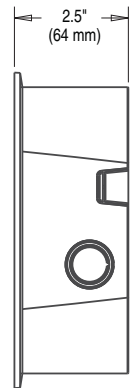

L-Series with LED: Ordering Information

Model	Description
L-Series with LED Horn Strobes	
P2RLED	2-Wire, Horn Strobe, Wall, Red
P2RLED-B	2-Wire, Horn Strobe, Wall, Red, Bilingual
P2WLED	2-Wire, Horn Strobe, Wall, White
P2WLED-B	2-Wire, Horn Strobe, Wall, White, Bilingual
P2GRLED	2-Wire, Compact Horn Strobe, Wall, Red
P2GRLED-B	2-Wire, Compact Horn Strobe, Wall, Red, Bilingual
P2GWLED	2-Wire, Compact Horn Strobe, Wall, White
P2GWLED-B	2-Wire, Compact Horn Strobe, Wall, White, Bilingual
P2RLED-P	2-Wire, Horn Strobe, Wall, Red, Plain
P2WLED-P	2-Wire, Horn Strobe, Wall, White, Plain
P2RLED-SP	2-Wire, Horn Strobe, Wall, Red, FUEGO
P2WLED-SP	2-Wire, Horn Strobe, Wall, White, FUEGO
PC2RLED	2-Wire, Horn Strobe, Ceiling, Red
PC2RLED-B	2-Wire, Horn Strobe, Ceiling, Red, Bilingual
PC2WLED	2-Wire, Horn Strobe, Ceiling, White
PC2WLED-B	2-Wire, Horn Strobe, Ceiling, White, Bilingual
L-Series with LED Strobes	
SRLED	Strobe, Wall, Red
SRLED-B	Strobe, Wall, Red, Bilingual
SWLED	Strobe, Wall, White
SWLED-B	Strobe, Wall, White, Bilingual
SGRLED	Strobe, Compact, Wall, Red
SGRLED-B	Strobe, Compact, Wall, Red, Bilingual
SGWLED	Strobe, Compact, Wall, White
SGWLED-B	Strobe, Compact, Wall, White, Bilingual
SRLED-P	Strobe, Wall, Red, Plain
SWLED-P	Strobe, Wall, White, Plain
SRLED-SP	Strobe, Wall, Red, FUEGO
SWLED-CLR-ALERT	Strobe, Wall, White, ALERT
SWLED-ALERT	Strobe, Wall, White, ALERT, Amber Lens
SCRLED	Strobe, Ceiling, Red
SCRLED-B	Strobe, Ceiling, Red, Bilingual
SCRLED-P	Strobe, Ceiling, White, Plain
SCWLED	Strobe, Ceiling, White
SCWLED-B	Strobe, Ceiling, White, Bilingual
SCWLED-P	Strobe, Ceiling, White, Plain
SCWLED-CLR-ALERT	Strobe, Ceiling, White, ALERT
L-Series Horns	
HRL*	Horn, Red
HRLA*	Horn, Red, Plain, ULC
HWL*	Horn, White
HWLA*	Horn, White, Plain, ULC
HGRL*	Compact Horn, Red
HGRLA*	Compact Horn, Red, Plain, ULC
HGWL*	Compact Horn, White
HGWLA*	Compact Horn, White, Plain, ULC

Model	Description
LED Lenses	
LENS-A3	Lens LED Amber Wall/Ceiling
LENS-B3	Lens LED Blue Wall/Ceiling
LENS-G3	Lens LED Green Wall/Ceiling
LENS-R3	Lens LED Red Wall/Ceiling
Accessories	
TR-2	Universal Wall Trim Ring Red
TR-2W	Universal Wall Trim Ring White
SBBRL	Wall Surface Mount Back Box, Red
SBBWL	Wall Surface Mount Back Box, White
SBBGRL	Compact Wall Surface Mount Back Box, Red
SBBGWL	Compact Wall Surface Mount Back Box, White
TRC-2	Universal Ceiling Trim Ring, Red
TRC-2W	Universal Ceiling Trim Ring, White
SBBCRL	Ceiling Surface Mount Back Box, Red
SBBCWL	Ceiling Surface Mount Back Box, White
Bezels†	
BZR	Wall Red Bezel Kit
BZW	Wall White Bezel Kit
BZGR	Compact Wall Red Bezel Kit
BZGW	Compact Wall White Bezel Kit
BZRC	Horn Strobe Ceiling Red Bezel Kit
BZWC	Horn Strobe Ceiling White Bezel Kit

Notes for L-Series With LED Horn Strobes and Strobes:

All -P models have a plain housing (no "FIRE" marking on cover).
 All -SP models have "FUEGO" marking on cover.
 All -ALERT models have "ALERT" marking on cover.
 All -B models have "FIRE/FEU" marking on cover for use in Canadian applications.
 Amber lenses are not for use in Canadian applications

Notes for L-Series Horns:

*Horn-only models are listed for wall or ceiling use.

Notes for Bezels:

†Each bezel pack ships in a package of 5.
 Add one of the following extensions for print/language options: -F (FIRE), -AL (ALERT), -EV (EVAC), -AG (AGENT), -P (Plain), -FR (FEU), -PG (FOGO), -SP (FUEGO), -SPE (FUEGO/FIRE).

3825 Ohio Avenue • St. Charles, IL 60174 USA
 Phone: 800-SENSOR2 • Fax: 630-377-6495
www.systemsensor.com

3333 Unity Drive, Mississauga, ON L5L 3S6 Canada
 Phone: 800-SENSOR2 • Fax: 905-812-0771
www.systemsensor.ca

System Sensor® is a registered trademark of Honeywell International, Inc.



©2023 System Sensor.
 Product specifications subject to change without notice. Visit www.systemsensor.com for current product information, including the latest version of this data sheet.
 AVDS916-01 • 10/03/2023

XP10-M(A)

Ten-Input Monitor Module



Addressable Devices

General

The **XP10-M ten-input monitor module** is an interface between a control panel and normally open contact devices in intelligent alarm systems such as pull stations, security contacts, or flow switches.

The first address on the XP10-M is set from 01 to 150 and the remaining modules are automatically assigned to the next nine higher addresses. Provisions are included for disabling a maximum of two unused addresses.

The supervised state (normal, open, or short) of the monitored device is sent back to the panel. A common SLC input is used for all modules, and the initiating device loops share a common supervisory supply and ground — otherwise each monitor operates independently from the others.

Each XP10-M module has panel-controlled green LED indicators. The panel can cause the LEDs to blink, latch on, or latch off.

NOTE: Unless otherwise specified, the term *XP10-M* is used in this data sheet to refer to both the *XP10-M* and the *XP10-MA* (ULC-listed version).

Features

- Listed to UL Standard 864, 9th edition.
- Ten addressable Class B or five addressable Class A initiating device circuits.
- Removable 12 AWG (3.31 mm²) to 18 AWG (0.821 mm²) plug-in terminal blocks.
- Status indicators for each point.
- Unused addresses may be disabled.
- Rotary address switches.
- Class A or Class B operation.
- FlashScan® or CLIP operation.
- Flexible mounting options.
- Mounting hardware included.

Specifications

Standby current: 3.5 mA (SLC current draw with all addresses used; if some addresses are disabled, the standby current decreases).

Alarm current: 55 mA (assumes all ten LEDs solid ON).

Temperature range: 32°F to 120°F (0°C to 49°C) for UL applications; -10°C to +55°C for EN54 applications.

Humidity: 10% to 85% noncondensing for UL applications; 10% to 93% noncondensing for EN54 applications.

Dimensions: 6.8" (172.72 mm) high x 5.8" (147.32 mm) wide x 1.25" (31.75 mm) deep.

Shipping weight: 0.76 lb. (0.345 kg) including packaging.

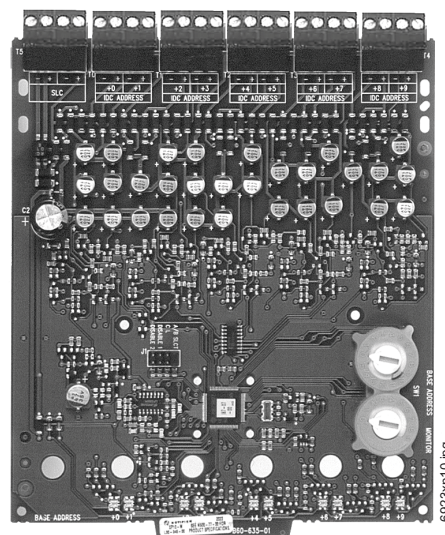

Mounting options:

- CHS-6 chassis: Up to 6 modules.
- BB-25 cabinet: Up to 6 modules.
- BB-XP cabinet: One or two modules.
- CAB-4 Series cabinet: See *DN-6857*.
- EQ Cabinet Series: See *DN-60229*.

Wire gauge: 12 AWG (3.31 mm²) to 18 AWG (0.821 mm²).

Power-limited circuits must employ type FPL, FPLR, or FPLP cable as required by Article 760 of the NEC.

XP10-M is shipped in Class B position; remove shunt for Class A operation.

Maximum SLC wiring resistance: 40 or 50 ohms, panel dependent.

Maximum IDC wiring resistance: 1500 ohms.

Maximum IDC voltage: 10.2 VDC.

Maximum IDC current: 240 μ A.

Agency Listings and Approvals

The listings and approvals below apply to the XP10-M(A) Ten-Input Monitor Module. In some cases, certain modules or applications may not be listed by certain approval agencies, or listing may be in process. Consult factory for latest listing status.

- **UL Listed:** S635
- **ULC Listed:** S635 (XP10-MA)
- **CSFM approved:** 7300-0028:219
- **FM approved**
- **MEA approved:** 43-02-E
- **Maryland State Fire Marshal approved:** Permit #2106

Product Line Information

XP10-M: Ten-input monitor module.

XP10-MA: Same as above with ULC Listing.

BB-XP: Optional cabinet for one or two modules. **Dimensions, DOOR:** 9.234" (23.454 cm) wide (9.484" [24.089 cm] including hinges), x 12.218" (31.0337 cm) high, x 0.672" (1.7068 cm) deep; **BACKBOX:** 9.0" (22.860 cm) wide (9.25" [23.495 cm] including hinges), x 12.0" (30.480 cm) high x 2.75" (6.985 cm); **CHASSIS (installed):** 7.150" (18.161 cm) wide overall x 7.312" (18.5725 cm) high interior overall x 2.156" (5.4762 cm) deep overall.

BB-25: Optional cabinet for up to six modules mounted on CHS-6 chassis (*below*). **Dimensions, DOOR:** 24.0" (60.96 cm) wide x 12.632" (32.0852 cm) high, x 1.25" (3.175 cm) deep, hinged at bottom; **BACKBOX:** 24.0" (60.96 cm) wide x 12.550" (31.877 cm) high x 5.218" (13.2537 cm) deep.

CHS-6: Chassis, mounts up to six modules in a CAB-4 Series (*see DN-6857*) cabinet, EQ Cabinet Series (*see DN-60229*), or BB-25.

FlashScan® and NOTIFIER® are registered trademarks of Honeywell International Inc. Microsoft® and Windows® are registered trademarks of the Microsoft Corporation.

©2009 by Honeywell International Inc. All rights reserved. Unauthorized use of this document is strictly prohibited.



This document is not intended to be used for installation purposes.
We try to keep our product information up-to-date and accurate.
We cannot cover all specific applications or anticipate all requirements.
All specifications are subject to change without notice.



Made in the U.S. A.

For more information, contact Notifier. Phone: (203) 484-7161, FAX: (203) 484-7118.
www.notifier.com



- Listings:** UL, cUL Listed
- Enclosure:** White ABS
- Dimensions:** 2 1/16"W x 3 7/16"L x 1 1/4"H
(5,2cm W x 8,7cm L x 3,2cm H)
- Sensor:** Epoxy sealed stainless steel case, bi-metallic operating mechanism.
- Contacts:** Silver clad, available normally open or normally closed
- Electrical Rating:** 1 Amp at 24VDC
- Temperature Setting:** 40° ±5°F (4,5° ±3°C)
- Terminals:** Screw Terminals
- Mounting:** Wall Mount, Surface

RTS-O Stock No. 1010108
RTS-C Stock No. 1010109

Application

The RTS Series complies with the requirements of NFPA 13 and 72 for a room temperature switch to operate at 40°F to protect a dry pipe valve from freezing. The RTS can also be used for other temperature detection applications.

Operation

The normally open detector, RTS-O, will close the contact when the temperature drops below 40°F (4,5°C). The normally closed detector, RTS-C, will open the contact when the temperature drops below 40°F (4,5°C). The detector will automatically reset to the normal state when the temperature rises above 40°F (4,5°C).

The RTS Series Room Temperature Sensors are precision engineered, designed and manufactured for commercial or residential use.

Description

Each unit consists of a bi-metal operating mechanism, featuring hermetically sealed precious metal contacts, N.O. or N.C., which automatically reset for repetitive operation, eliminating the need for sensing element replacement.

Small compact design, highly resistant to vibration and corrosion. Easily installed using the enclosed hardware or adhesive mounting pad.

Screw terminals permit easy installation in single or multiple detector circuits.

Features:

- Easily installed
- Completely sealed sensor, moisture and vapor resistant
- Highly resistant to vibration and corrosion
- Highly sensitive to temperature changes
- No sensitivity loss due to aging
- Repetitive operation without the need to replace sensing elements
- Small compact design
- Precision and quality at low cost

Customer:	
Project:	
Engineer:	
Architect:	
PRO or PO:	
QTY:	



PAM-1 and PAM-2 Multi-Voltage Relay Modules

Section: Miscellaneous

GENERAL

Air Products & Controls, Inc. **PAM-1** and **PAM-2 Multi-Voltage Relay Modules** are encapsulated multi-voltage devices. The PAM-1 relay provides 10.0 Amp Form-C contacts and may be energized by one of three input voltages: 24 VAC, 24 VDC, or 115 VAC. The PAM-2 relay provides 7.0 Amp Form-C contacts and may be energized by one of two input voltages: 12 VDC or 24 VDC.

A red LED is provided on both models. When illuminated, it indicates the relay coil is energized.

Either model may be mounted by using the double-sided adhesive tape, the self-drilling screw, or by placing loosely in a backbox.

PAM-1 and PAM-2 Relay Modules are ideal for applications where remote relays are required for control or status feedback. They are suitable for use with HVAC, temperature control, fire alarm, security, energy management, and lighting control systems.

SPECIFICATIONS

Power requirements: *for PAM-1:* 0.015 Amps per position @ 24 VDC, 24 VAC, 115 VAC; *for PAM-2:* 0.015 Amps per position @ 12 VDC or 24 VDC.

Relay: UL-recognized SPDT.

Contact rating, PAM-1: 10.0 A @ 115 VAC; 7.0 A @ 28 VDC; 250 μ A @ 5 VDC.

Contact rating, PAM-2: 7.0 A @ 115 VAC; 7.0 A @ 28 VDC; 250 μ A @ 5 VDC.

Ambient temperature range: -58°F to +185°F (-50°C to +85°C).

Dimensions: 1.500" (38.100 mm) high x 1.000" (25.400 mm) wide x 0.875" (22.225 mm) deep, with 12" (304.8 mm) wire leads @ 18 AWG (0.75 mm²).

WIRING DIAGRAMS

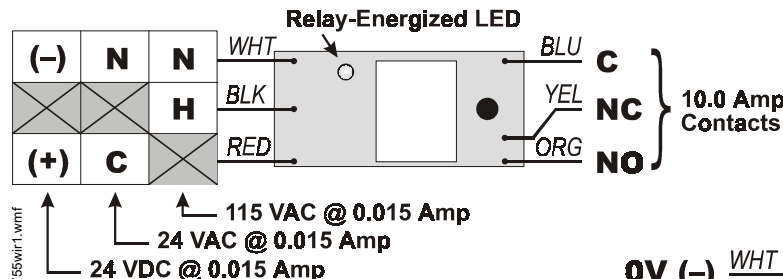

MEA
73-92-E
Vol. XXI



California
State Fire
Marshal
7300-1004:101



PRODUCT LINE INFORMATION

PAM-1 Single SPDT relay with LED, double-sided adhesive tape, mounting screw, 12" (304.8 mm) leads and six wire-nuts. **Power requirements:** 0.015 Amps per position @ 24 VDC, 24 VAC, 115 VAC. **Contact rating:** 10.0 A @ 115 VAC, 7.0 A @ 28 VDC, 250 μ A @ 5 VDC.

PAM-2 Single SPDT relay with LED, double-sided adhesive tape, mounting screw, 12" (304.8 mm) leads and six wire-nuts. **Power requirements:** 0.015 Amps per position @ 12 VDC or 24 VDC. **Contact rating:** 7.0 A @ 115 VAC; 7.0 A @ 28 VDC; 250 μ A @ 5 VDC.

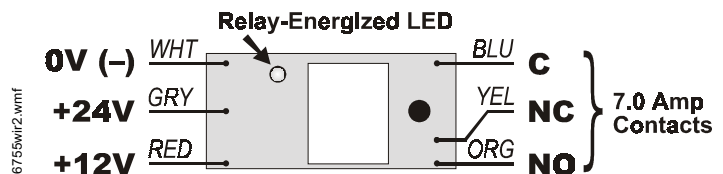

This document is not intended to be used for installation purposes. We try to keep our product information up-to-date and accurate. We cannot cover all specific applications or anticipate all requirements. All specifications are subject to change without notice. For more information, contact NOTIFIER. Phone: (203) 484-7161 FAX: (203) 484-7118

NOTIFIER 12 Clintonville Road, Northford, Connecticut 06472

ISO 9001
CERTIFIED
ENGINEERING & MANUFACTURING

BAT Series Batteries

Sealed Lead-Acid



Power Supplies

General

BAT Series Batteries are Power-Sonic brand batteries. BAT Series (or Power-Sonic brand) batteries are recommended for secondary power or backup power for all NOTIFIER fire alarm control equipment.

Features

- Provide secondary power for control panels.
- Sealed and maintenance-free.
- Overcharge protected.
- Easy handling with leak-proof construction.
- Ruggedly constructed, high-impact case (ABS).
- Long service life.
- Compact design.

Agency Listings and Approvals

The listings and approvals below apply to BAT Series Batteries. In some cases, certain modules may not be listed by certain approval agencies, or listing may be in process. Consult factory for latest listing status.

- **UL Recognized Components:** MH20845 (*Power-Sonic*).



6933cov.jpg

Ordering Information

BAT-1250-BP: 10-unit bulk pack of BAT-1250 (12 V 5 AH).

BAT-1270-BP: 5-unit bulk pack of BAT-1270 (12 V 7 AH).

BAT-12120-BP: 4-unit bulk pack of BAT-12120 (12V 12 AH).

BAT-12180-BP: 2-unit bulk pack of BAT-12180 (12 V 18 AH).

BAT-12260-BP: 2-unit bulk pack of BAT-12260 (12 V 26 AH).

BAT-12550: single battery (12 V 55 AH).

BAT-121000: single battery (12 V 100 AH).

Part Number Reference & Specifications

Part Number	Power-Sonic Part Number	Battery Description			DIMENSIONS									
		Nominal Voltage V	Nominal Capacity @ 20 hr. rate A.H.		Width		Depth		Height		Height over terminal		Weight	
					in.	mm	in.	mm	in.	mm	in.	mm	lb.	kg.
BAT-1250	PS-1250	12	5	sealed	3.54	90	2.76	70	3.98	101	4.21	107	3.50	1.59
BAT-1270	PS-1270	12	7	sealed	5.95	151	2.56	65	3.7	94	3.86	98	4.8	2.18
BAT-12120	PS-12120	12	12	sealed	5.95	151	3.86	98	3.7	94	3.94	100	7.92	3.59
BAT-12180	PS-12180	12	18	sealed	7.13	181	3.00	76	6.59	167	6.59	167	12.6	5.72
BAT-12260	PS-12260	12	26	sealed	6.5	167	6.97	177	4.92	125	4.92	125	17	7.71
BAT-12550	PS-12550	12	55	sealed	9.04	230	5.45	138	8.15	207	8.98	228	36	16.33
BAT-121000	PS-121000	12	100	sealed	12	305	6.6	168	8.15	207	8.98	228	68	30.84

Discharge Characteristic Curves at 20°C (68°F)

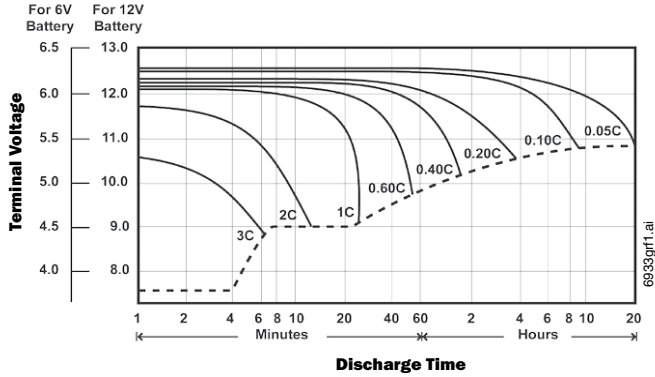

Effect of Temperature on Capacity

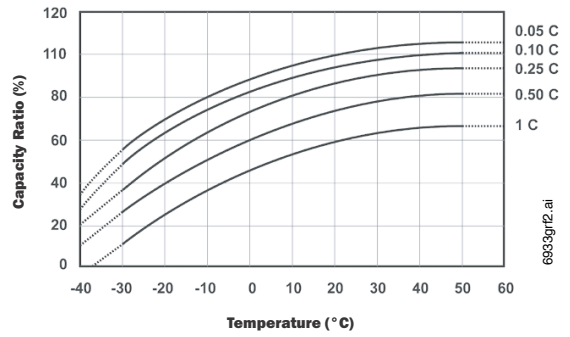

PS-121000 Shelf-Life and Storage

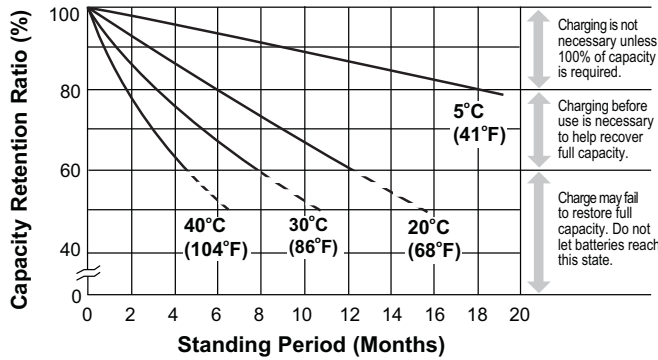

PS-121000 Discharge Characteristics

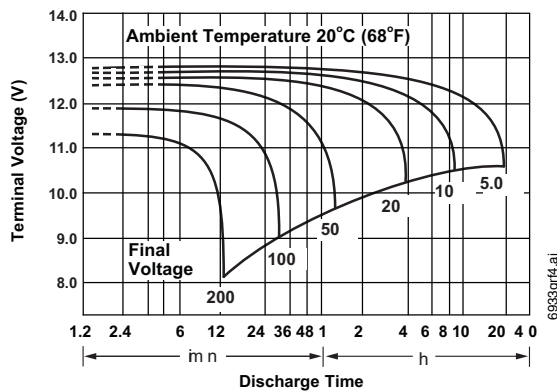

NOTIFIER® is a registered trademark of Honeywell International Inc. Batteries display trademarks of the manufacturer. ©2013 by Honeywell International Inc. All rights reserved. Unauthorized use of this document is strictly prohibited.



This document is not intended to be used for installation purposes. We try to keep our product information up-to-date and accurate. We cannot cover all specific applications or anticipate all requirements. All specifications are subject to change without notice.

For more information, contact Notifier. Phone: (203) 484-7161, FAX: (203) 484-7118. www.notifier.com

DTK-TSS4D

Series Connected Surge Protector



Product Features

- Series design for fast response and best protection
- Multi-stage hybrid circuit design
- UL1283 EMI/RFI filtering
- LED indicates protection status
- Form C Dry Contact circuit
- UL Listed NEMA 4X enclosure

Applications

- Fire Alarm Panels
- Control Panels
- 120VAC Single Phase Critical Loads
- Applications where a UL Listed SPD is required

DITEK's Total Surge Solution (TSS) is a range of products that provide total surge protection for addressable and conventional alarm systems.

The DTK-TSS4D protects dedicated 120VAC power circuits that feed control panels and other critical equipment. It includes dry contacts for remote notification of surge protection status and EMI/RFI filtering to ensure clean power for connected equipment.

Technical Specifications

Service Voltage:	120VAC
MCOV:	150VAC
Protection Modes:	All modes (L-G, L-N, N-G)
Voltage Protection Rating:	600VAC
Surge Current Rating:	54,000 Amps
Max. Continuous Current:	20 Amps
SCCR:	10kA
Nominal Discharge Current Rating:	3kA
EMI/RFI Filtering Attenuation:	Up to 35dB, 100kHz -100MHz

Mechanical Characteristics

Connection Method:	Hardwired, series configuration
Housing:	Polycarbonate NEMA 4X (IP66) UL94 Flammability Rating
Operating Temperature:	-40°F - 185°F (-40°C - 85°C)
Maximum Humidity:	95% non-condensing
Dimensions:	9.5"L x 6.25"W x 3.63"H (241mm x 159mm x 92mm)
Weight:	1.8lb (0.45kg)

Quality, Standards & Approval

Agency Approvals:	UL1449, cUL, UL1283
SPD Type:	Type 2 SPD
Standards Compliance:	IEEE C62.41.1 -2, IEEE C62.45
Warranty:	Ten Year Limited Warranty

Every precaution has been taken to ensure that this literature is accurate and complete. DITEK Corporation assumes no responsibility and disclaims all liability for damages resulting from the use of this information or for any errors or omissions.



DTK-LVLP Series

Voice, Data and Signaling Circuit Surge Protection



DTK-4LVLPX

DTK-2LVLPV

Product Features

- Protect 1, 2, 4 or 8 pairs to match your specific configuration needs
- Series connection, parallel function adds no resistance to loop circuits
- Seven voltage levels available to protect all types of voice/data/signaling applications
- "SCP" models provide automatic resetting fuse and sneak current protection

Applications

- 4-20mA Current Loops
- Alarm Panel NAC, SLC, PIV and IDC Loops
- Burglar Alarm Panels
- Speakers and Phones

Accessories

- DIN Rail Kit (DTK-DRK)

Selection Guide

Example: DTK-2LVLPSCPLV

DTK-2LVLPSCPLV

2 Pairs 24 Volts

DITEK's DTK-LVLP Low Voltage Line Protector series of signal, data and loop circuit surge protectors provide strong protection in a compact hard wired package. Models are available to protect up to 8 pairs. LVLAWG models can handle #14-#10 AWG wiring connections. Both are suitable for AC and DC circuits.

Technical Specifications

Protection Modes:	Line-Ground (All)
Surge Current Rating:	2,000 Amps per pair (5V – 48V) 9,000 Amps per pair (75V – 130V)
Max. Continuous Current:	5 Amps, 0.15 Amps (SCP)

Mechanical Characteristics

Connection Method:	Screw Terminals : #22 - #16 AWG (LVLP), #14 - #10 AWG (LVLAWG)
Housing:	ABS
Operating Temperature:	-40°F - 158°F (-40°C - 70°C)
Maximum Humidity:	95% non-condensing
Dimensions (1LVL – 4LVL):	3.0L x 1.6"W x 1.6"H (76mm x 41mm x 41mm)
Dimensions (8LVL):	4.8"L x 2.3"W x 1.5 "H (122mm x 58mm x 35mm)
Weight:	2.4 oz (68g)

Quality, Standards & Approval

Agency Approvals:	UL497A, UL497B
Warranty:	Ten Year Limited Warranty

VOLTAGE LEVEL	D	X	LV	OPX	RUV
Pairs Available:	2, 4, 8	1, 2, 3, 4	1, 2, 4, 8	2, 4	2, 4
Service Voltage:	5V	12V	24V	48V	130V
Sneak Current Protection Available? (SCP):	Yes	Yes	Yes	No	Yes
MCOV:	8VDC	18VDC	38VDC	66VDC	175VDC
Clamping Voltage:	12V	22V	47V	82V	204V

Every precaution has been taken to ensure that this literature is accurate and complete. DITEK Corporation assumes no responsibility and disclaims all liability for damages resulting from the use of this information or for any errors or omissions.

Area Rescue

Submittal Data For:

Cape Fear Valley Heath - Harnett

Core & Shell

225 Brightwater Drive

Lillington, NC 27546



Model Numbers:

- 2500-205D (Up to 5 Call Boxes)
 - 2500-210D (Up to 10 Call Boxes)
- Size:** 12.56" H x 11.6" W x 1.68" D
(4.36" D with handset)

Style:

- Stainless Steel
- Surface mount
- Coil cord



Model Numbers:

- 2500-205PSS (Up to 5 Call Boxes)
- 2500-210PSS (Up to 10 Call Boxes)

Size:

Face: 13.81" H x 13.81" W x 1.68" D
(2.67" D with handset)

Back Box: 12.56" H x 11.6" W x 1.68" D

Style:

- Stainless Steel
- Steel back box
- Flush mount
- Coil cord



Model Numbers:

- 2500-205B (Up to 5 Call Boxes)
- 2500-210B (Up to Call Boxes)

Size: 15.07" H x 12" W x 6" D

Style:

- Powder coated steel enclosure
- Surface mount
- Twist lock closure for use with Fireman's lock (not provided)
- Coil cord



Model Numbers:

- 2500-205FM (Up to 5 Call Boxes)
- 2500-210FM (Up to 10 Call Boxes)

Size:

• Face: 16.11" H x 14" W x 3" D

• Back Box: 15.62" H x 12" W x 3" D

Style:

- Powder coated steel enclosure
- Flush mount
- Twist lock closure for use with Fireman's lock (not provided)
- Coil cord

Features:

- Run twisted and shielded 4 wire set from each Call Box to Base Station unit and one standard phone line to outside world
- Requires a single analog (POTS, PBX, or central office phone line) or digital phone line. If used on a VoIP or cellular network, you must purchase a RATH® 2100-VOIP2CS or 2100-GSMLC4 Gateway Device.
- Easy to use push buttons
- Passively monitor communications between Call Boxes and outside world via the LEDs:
 1. Solid lit LED indicates there is an emergency call in progress
 2. Slow blinking LED indicates there is a call on hold
- Audible alert when Call Box initiates call, silenced when call is joined from Base Station
- Includes relay contact that trips if any Call Box has been activated
- The Base Station is able to:
 1. Call into all or individual Call Boxes as needed
 2. Join existing conversations between Call Boxes and outside world
 3. Hang up and original conversation will continue
 4. Terminate outside world so it is only talking to the Call Boxes or terminate the call with all parties entirely
- Volume control handset meets ADA requirements
- Designed for either 120vac or 24vdc power
- 16.8V 1400mAH battery (part # RP7300109A)
- Built-in battery backup recharges from 120vac or 24vdc power (allows for a minimum of 4 hours talk time upon loss of power)
- Telephone Line Voltage: 24v-48v
- Meets all IBC, ADAAG, and NFPA code requirements
- 3 year warranty
- Conforms to UL Standard 2017 for Attendant Monitored Signaling Devices
- Complies with Section 6.4 of UL 60950-1
- ETL Listing Number: 5013373



Part #: 2100-958NSR

Face Plate Size: 9-1/2" H x 7-1/2" W

Back Box Size: 8" H x 6" W x 3" D

Style: Brushed Stainless Steel, Flush Mount

Options: Strobe Interface & Relay, Mushroom Push Button

Features:

- Meets all IBC, ADAAG, and NFPA code requirements
- Requires an analog telephone line (POTS, PBX, or central office line)
- Power Requirements: 24vdc from model 2500-PWR24U
- 7.2V 300mAH battery (part #: RP7300110)
- Built-in battery backup recharges from 24vdc power (allows for a minimum of 4 hours of talk time upon power loss)
- Built-in 10 phone consolidator feature allows you to install 10 Call Boxes and 1 Base Station on a single telephone line
- Programmable with up to 5 emergency numbers
- On-site programming
- Remote or on-site diagnostic test
- Recordable location message (18 seconds)
- Phone checks every 24 hours for an active phone line, if one is not detected, phone will provide a relay trip
- Compatible with the SmartRescue Base Station or Command Center for in-building rescue coordination
- Automatic dialer (31 digit programmable memory)
- Automatic answer feature with audible ring
- Touch Tone operation only (Touch Tone is an AT&T registered trademark)
- Optional strobe interface and relay
- 3 year warranty
- Conforms to UL Standard 2017 for Attendant Monitored Signaling Device
- Complies with Section 6.4 of UL 60950-1
- ETL Listing Number: 5013373

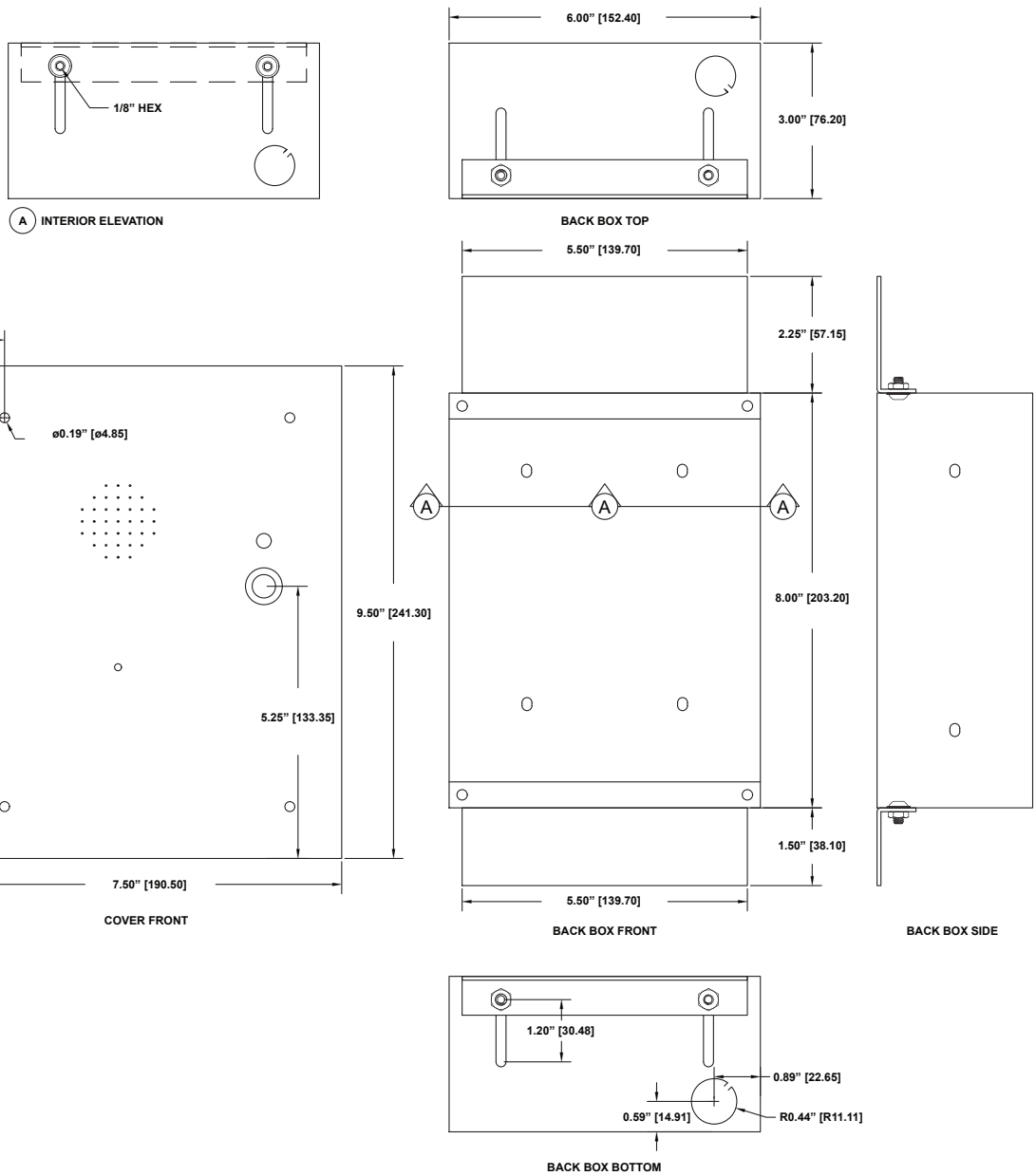
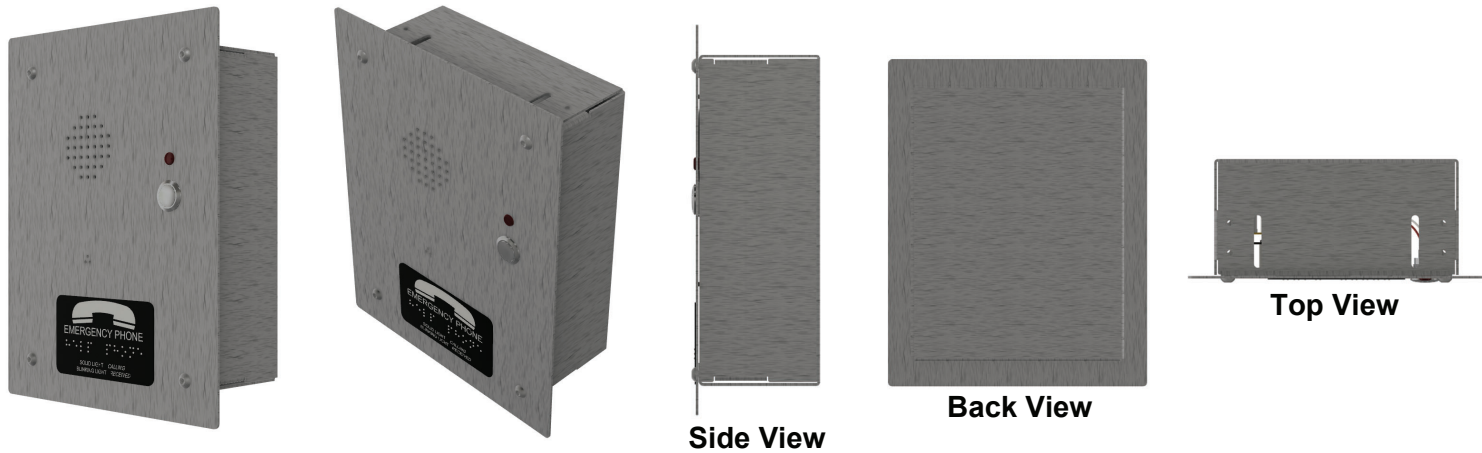



Recognized
Component



Intertek
Conforms to
UL STD 2017

Part #: 2500-PWR24U

Size:

- 8.78" H x 12.29" W x 2.81" D

Input:

- 100-120vac, 50/60Hz, 4.0A

Output:

- 24vdc @5A total continuous output
- Filtered and electronically regulated output
- 12 PTC protected outputs @0.500A current limited
- Class 2
- 24vdc adjustable output
- 24vdc S1 on/off switch
- Input and output status LED indicators

Protection:

- Short Circuit/Overload/Over Voltage

Supervision:

- DC power failure supervision (form C contacts)

Environmental:

- For indoor use ONLY
- Operating temperature 32° F to 120° F (0° C to 49° C) ambient



Side View

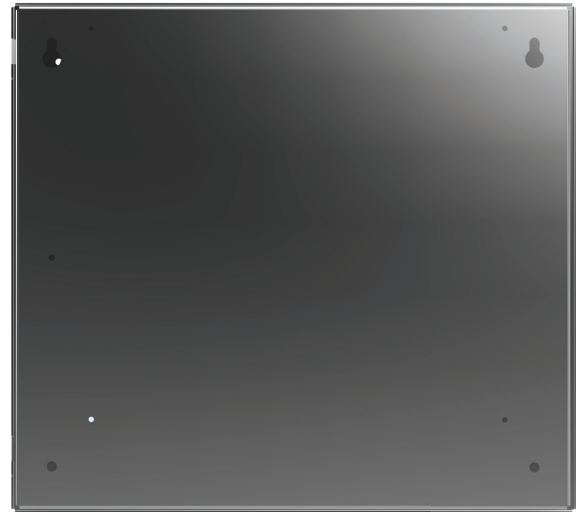

Back View



Top View

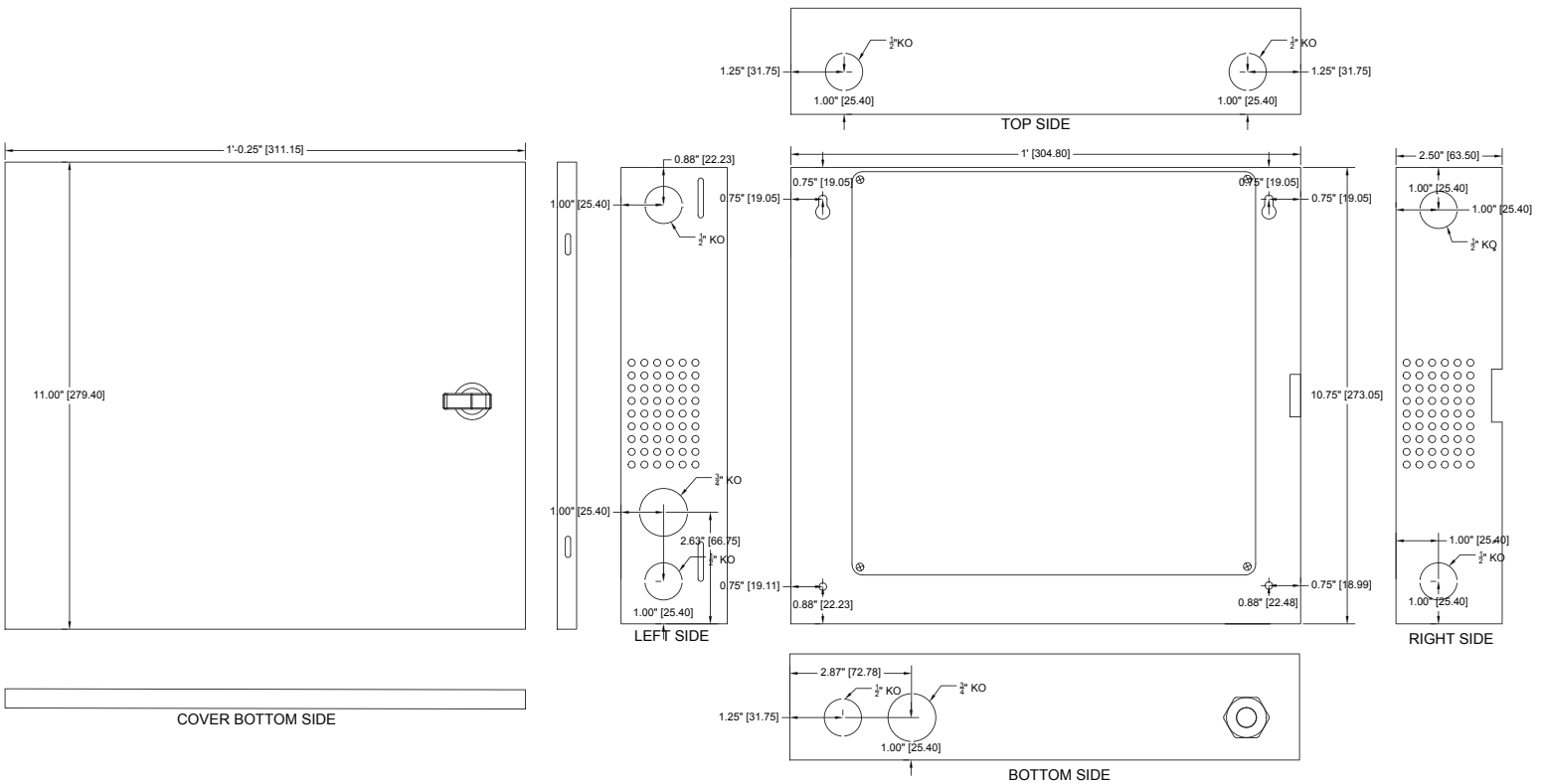



Area of Refuge & Elevator Landing Communication Systems
Emergency Communication Sign 7087



Specifications:

- 7-3/4" H x 7-3/4" W
- Raised letter and braille
- Peel and stick mounting for easy installation
- Sign should be mounted between 48" - 60" from floor to lowest tactile characters
- IBC, NFPA, and ADAAG code compliant



Sign Specifications:

- 7-3/4" H x 7-3/4" W
- Peel and stick mounting for easy installation
- Sign should be mounted above 60" but below 80" from floor to top of sign
- IBC, NFPA, and ADAAG code compliant

Photo Luminescent Material Specifications:

- Base material is PVC and a non-toxic pigment is added to create the photo luminescent effect
- Material is listed under UL 1994
 - After being exposed to 1 foot candle of light for 60 minutes, a minimum luminance shall be 30 millicandelas per square meter at 10 minutes and 5 millicandelas per square meter after 90 minutes
 - Also meets IBC 2015 Section 1025.4 and New York Local Law 24
- Typical material life expectancy is 25+ years



Area of Refuge & Elevator Landing Communication Systems
Call Box Instruction Sign 7049SS

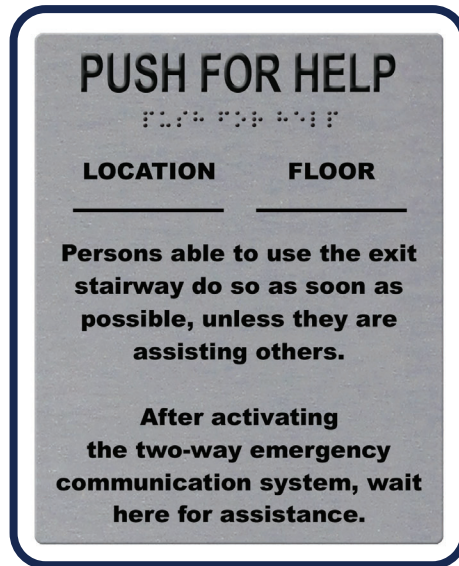

Specifications:

- 8" H x 6" W
- Silver finish
- Raised letter and braille
- Peel and stick mounting for easy installation
- Sign should be mounted above or adjacent to each Call Box
- Required for each Call Box per IBC Section 1007.11
- IBC, NFPA, and ADAAG code compliant

