

THESE DRAWINGS ARE INSTRUMENTS OF SERVICE AND SHALL REMAIN THE PROPERTY OF THE ARCHITECT. THESE DRAWINGS ARE NOT TO BE REPRODUCED OR COPIED IN ANY MANNER WITHOUT THE WRITTEN CONSENT OF THE ARCHITECT.  
© 2012 ERSKINE-SMITH ARCHITECTURE, P.L.L.C.

**ERSKINE-SMITH ARCHITECTURE, P.L.L.C.**  
architecture research planning  
3406-A West Wendover Avenue  
Greensboro, N.C. 27407  
Phone (336) 855-1286 Fax 855-5602

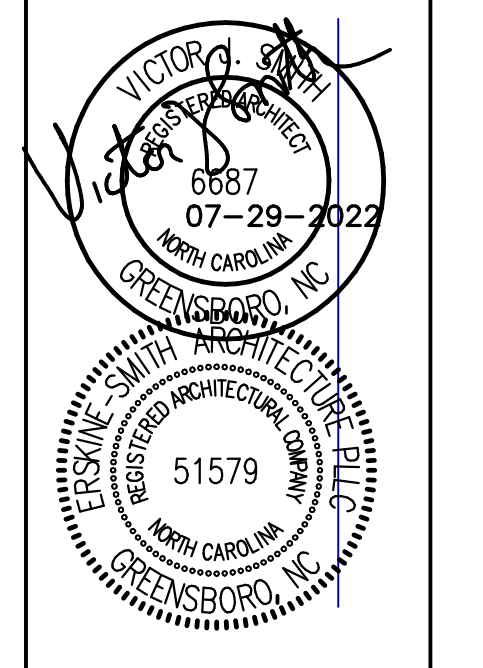

# BUILDING 'A' NEW STORAGE FACILITY FOR HARNETT SELF STORAGE SPOUT SPRINGS, NC

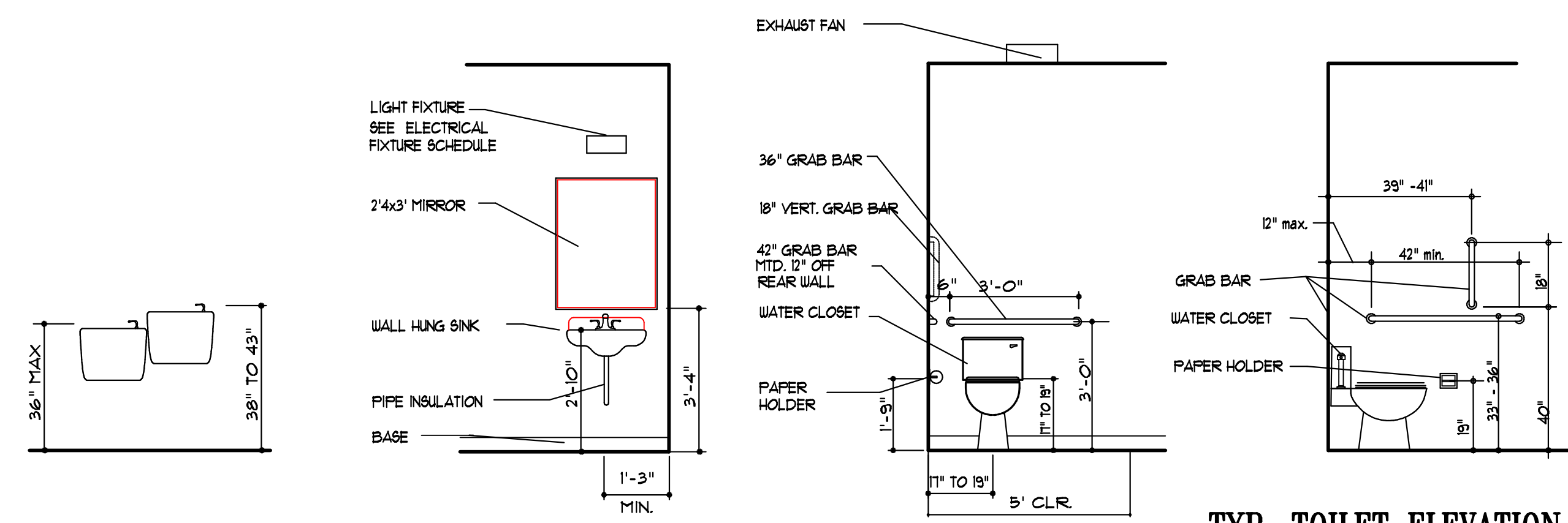

**WATER FOUNTAIN**  
**SINK ELEVATION**  
**TYP. TOILET ELEVATION**

NOTE: PROVIDE BLOCKING IN ALL WALLS BEHIND GRAB BARS + WALL HUNG SINKS AS PER HANDICAPPED CODE

NOTE: ALL DIMENSIONS TAKEN TO FACE OF FINISH SURFACE

NOTE:  
ADA UNITS WILL INCLUDE AN ELECTRIC DOOR LIFT OPERATOR WITH BATTERY BACKUP, PHOTO EYES, EMERGENCY RELEASE AND KEYPAD FOR OPERATION. KEYPAD WILL BE MOUNTED WITHIN ACCESSIBLE REACH RANGES PER ANSI 308. MANUFACTURER: LIFTMASTER 8950W OR EQUAL

HORIZONTAL SLIDING DOORS SHALL COMPLY WITH SECTION 1010.1.4.3 OF NCBC. ELECTRICAL TO BE COORDINATED.

OCCUPANT DISPERSAL FROM EXITS TO PUBLIC ROAD SHOWN ON SITE PLAN

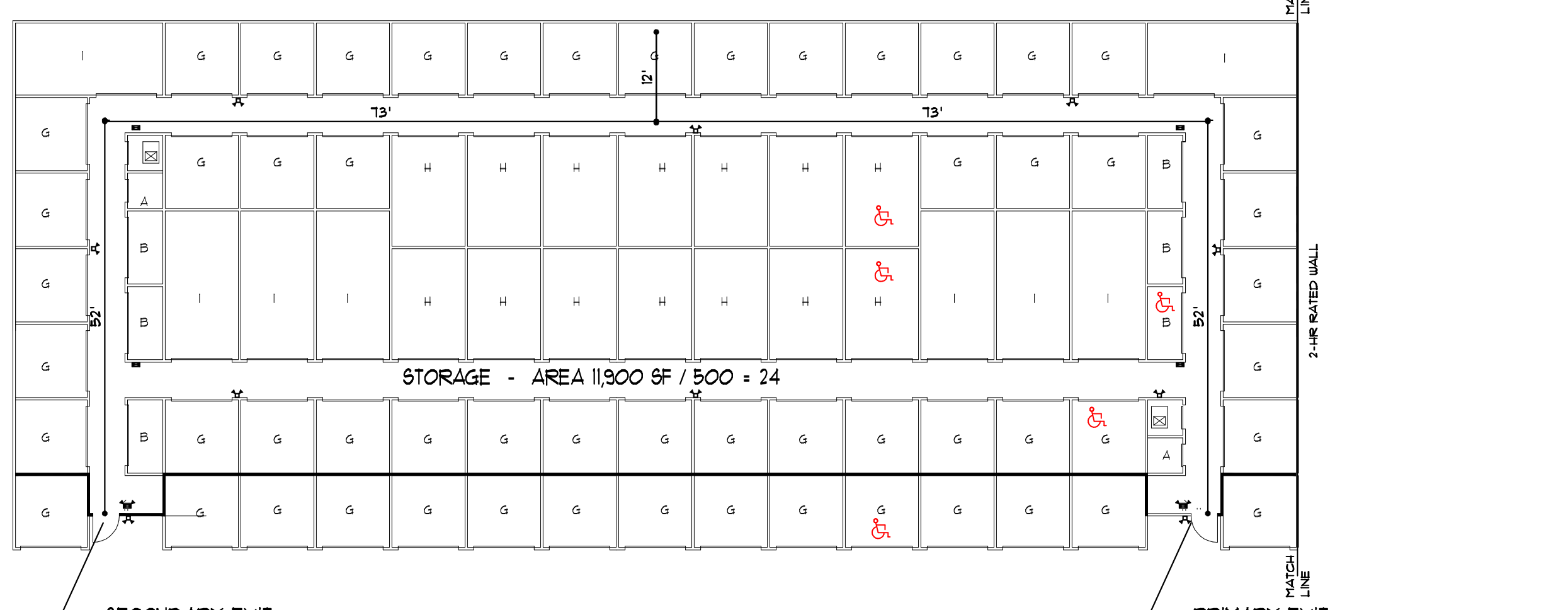

**FLOOR PLAN - AREA 'A'**  
1/16" = 1'-0"

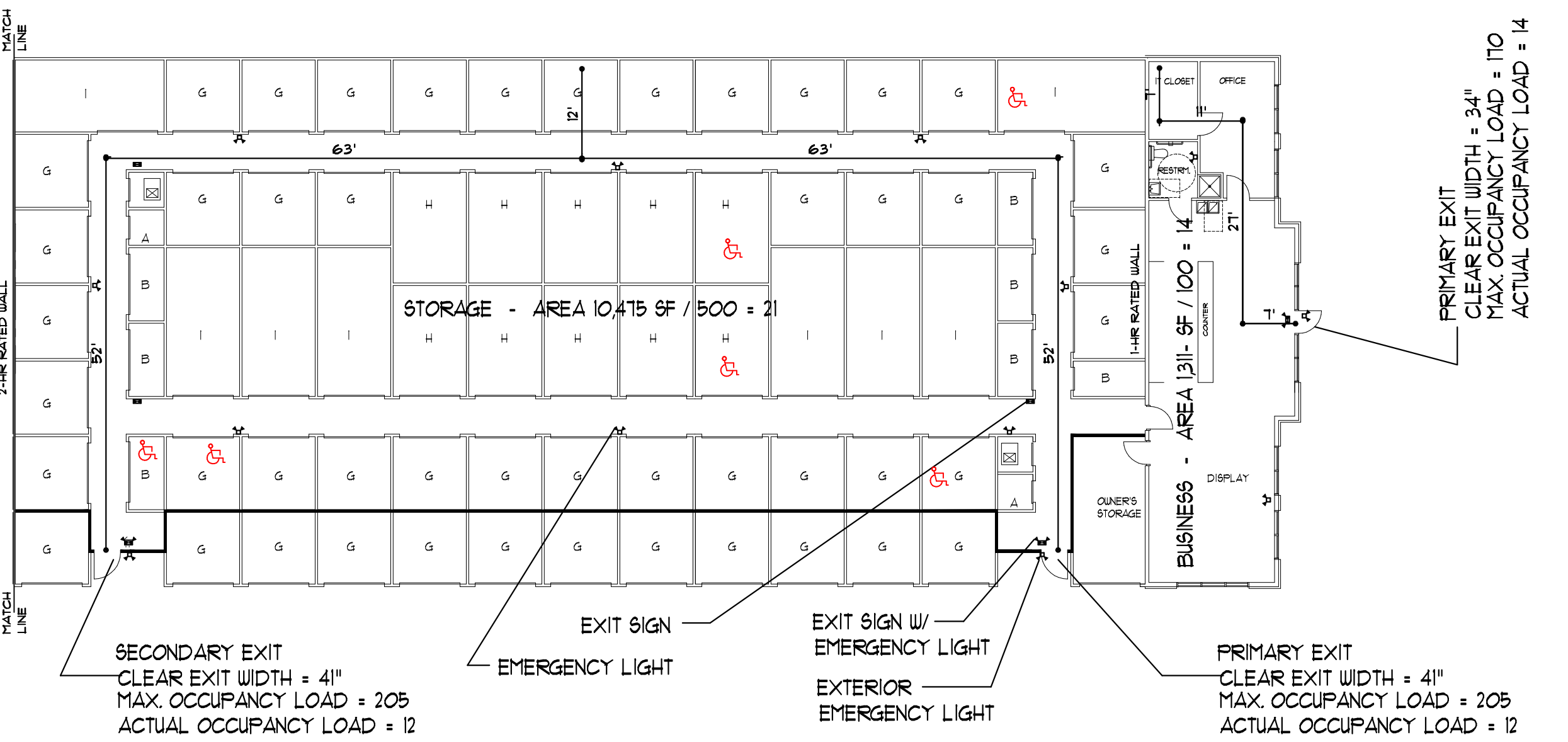

**LIFE SAFETY & OCCUPANCY PLAN**  
1/16" = 1'-0"

## APPENDIX "B" BUILDING CODE SUMMARY

Name of project: BLDG. 'A' NEW FACILITY FOR HARNETT SELF STORAGE  
Address: \_\_\_\_\_ Zip Code: \_\_\_\_\_  
Owner or Authorized Agent: VCS SMITH Phone: 336-855-1286 E-mail: erskinesmith@bellsouth.net  
City/County: SARTFORD Private State  
Code Enforcement Jurisdiction: City/County

DESIGNER: Victor J. Smith  
ARCHITECTURAL: ERSKINE-SMITH ARCHITECTURE, P.L.L.C. License No. 6687  
ELECTRICAL: EUBANKS HUMPHREY ENGINEERING, P.C. License No. 032588  
PLUMBING: EUBANKS HUMPHREY ENGINEERING, P.C. License No. 032588  
MECHANICAL: EUBANKS HUMPHREY ENGINEERING, P.C. License No. 032588

2018 NC BUILDING CODE:  New Building  Addition  Renovation  
 Shell/Core - Contact the local inspection jurisdiction for possible additional procedures and requirements  
 Phased Construction - Shell/Core - Contact the local inspection jurisdiction for possible additional procedures and requirements

2018 NC EXISTING BUILDING CODE, EXISTING:  Prescriptive  Repair  Chapter 14 Alterations  Level II  Level III  Historic Property  Change of Use

CONSTRUCTION (date): \_\_\_\_\_ ORIGINAL OCCUPANCY (Ch. 3): \_\_\_\_\_  
RENOVATED (date): \_\_\_\_\_ PROPOSED OCCUPANCY (Ch. 3): STORAGE

RISK CATEGORY (Table 1604.3):  I  II  III  IV

BASIC BUILDING DATA  
Construction Type:  I-A  I-B  II-A  II-B  III-A  III-B  IV  V-A  V-B  
Sprinklers:  No  Partial  Yes  NFPA 13  NFPA 13R  NFPA 13D  
Standpipes:  No  Yes  Class:  I  II  III  IV  Dry  
Fire District:  No  Yes  Flood Hazard Area:  No  Yes  
Special Inspections Required:  No  Yes (Contact the local inspection jurisdiction for additional procedures and requirements)  
Manual Fire Alarm System with Notification:  No  Yes

FLOOR	EXISTING (SQ FT)	NEW (SQ FT)	SUB-TOTAL
4th Floor			
3rd Floor			
2nd Floor			
Mezzanine	Area A	Area B w/ office	
1st Floor	11,683 sf	11,800	
Basement			
TOTAL	11,683 sf	11,800	23,483 SF TOTAL

Primary Occupancy Classification(s):  A-1  A-2  A-3  A-4  A-5  
Assembly  Educational  F-1 Moderate  F-2 Low  High Hazard  H-1 Detached  H-2 Detached  H-3 Combust  H-4 Health  H-5 HPM  
Institutional  I-1 Condition  I-2  I-3 Condition  I-4  
Mercantile  R-1  R-2  R-3  R-4  
Residential  S-1 Moderate  S-2 Low  High Piled  
Storage  Parking Garage  Open  Enclosed  Repair Garage  
Utility and Miscellaneous

Accessory Occupancy Classification(s): BUSINESS  
Special Uses (Chapter 4 - List Code Sections): NA  
Special Provisions (Chapter 5 - List Code Sections): NA  
Mixed Occupancy:  No  Yes Separation:  Hr. Exception: \_\_\_\_\_  
Non-separated use (508.3)  
The required type of construction for the building shall be determined by applying the height and area limitations for each of the applicable occupancies to the entire building. The most restrictive type of construction, so determined, shall apply to the entire building.  
 Separated Mixed Occupancy (508.4) - See below for area calculations. For each story, the area of the occupancy shall be such that the sum of the ratios of the actual floor area of each use divided by allowable floor area for each use shall not exceed 1.  
Actual Area of Occupancy A + Actual Area of Occupancy E ≤ 1  
Allowable Area of Occupancy A + Allowable Area of Occupancy E ≤ 100

STORY NO.	DESCRIPTION AND USE	(A) BLDG AREA PER STORY (ACTUAL)	(B) TABLE 506.2 AREA	(C) AREA FOR FRONTAGE INCREASE (1.4)	(D) ALLOWABLE AREA PER STORY (QUALIFIED 1)

(1) Frontage area increases from Section 506.2 are computed thus:  
a. Perimeter which fronts a public way or open space having 20 feet minimum width = (F)  
b. Total Building Perimeter = (P)  
c. Ratio (F/P) = \_\_\_\_\_  
d. W = Minimum width of public way = (W)  
e. Percent of frontage increase =  $(\frac{W}{100(F/P - 0.25)} + W)30 = \%$

(2) Unlimited area applicable under conditions of Section 507  
(3) Maximum Building Area = total number of stories in the building x D (506.2)  
(4) The maximum area of open parking garages must comply with 406.5.4. The maximum area of air traffic control towers must comply with 403.3.  
(5) Frontage increase is based on the unspinklered area value in Table 506.2

ALLOWABLE HEIGHT

Allowable	Show on plans	Code Reference
55 FT.	20'	

Building Height in Feet (Table 504.3)  
Building Height in Stories (Table 504.4)  
Provide code reference if the "Shown on Plans" quantity is not based on Table 504.3 or 504.4.

NS = BUILDING NOT EQUIPPED THROUGHOUT WITH AN AUTOMATIC SPRINKLER SYSTEM

**FIRE PROTECTION REQUIREMENTS**

BUILDING ELEMENT	FIRE SEPARATION (FEET)	RATING	DETAIL AND SHEET #	DESIGN FOR RATED ASSEMBLY	DESIGN FOR RATED PENETRATION	DESIGN FOR RATED JOINTS
Structural Framing, including columns, girders, trusses	0					
Bearing walls						
Exterior						
NORTHWEST	6'-6"	0				
NORTHEAST	6'-6"	0				
SOUTHWEST (ASSUMED PROPERTY LINE)	15'	0				
SOUTHWEST WALL	3'-6"	0				
Interior						
Nonbearing walls and partitions						
Exterior walls						
North	N/A	0				
East	N/A	0				
West	N/A	0				
South	N/A	0				
Interior walls & partitions						
Floor construction including supporting beams and joists	0					
Floor Ceiling Assembly	0					
Columns supporting roof	0					
Roof construction including supporting beams and joists	0					
Floor Ceiling Assembly	0					
Columns supporting roof	N/A					
Shells Enclosures - Exit	N/A					
Shells Enclosures - Other	N/A					
Corridor Separation	N/A					
Occupancy/Fire Barrier Separation	1-hr	1-hr	U-419	T/A-3		
PartyFire Wall Separation	2-hr	2-hr	U-419	3/A-3		
Smoke Barrier Separation	N/A					
Tenant / Dwelling Unit / Sleeping Unit Separation	N/A					
Incidental Use Separation	N/A					

\* Indicate section number permitting reduction

**PERCENTAGE OF WALL OPENINGS CALCULATION**

Fire Separation Distance (feet) / Assumed Property Line	Degree of Opening Protection (Table 705.8)	Allowable Area (%)	Actual Shown on Plan (%)
NORTH 100'	UNPROTECTED, NONSPINKLERED	NO LIMIT	0
WEST 30'	UNPROTECTED, NONSPINKLERED	NO LIMIT	0
SOUTH 25'	UNPROTECTED, NONSPINKLERED	NO LIMIT	0
EAST 15' ASSUMED PROPERTY LINE	UNPROTECTED, NONSPINKLERED	NO LIMIT PER TABLE 705.8.1 ex. 2	54%

**LIFE SAFETY PLAN REQUIREMENTS**

Life Safety Plan Sheet - COVER SHEET  
NA  Fire and/or smoke rated wall locations (Chapter 7)  
NA  Assumed and real property line locations (if not on site plan)  
NA  Exterior wall opening area with respect to distance to assumed property lines (105.8)  
NA  Occupancy Use for each area as it relates to occupancy load calculation (Table 1004.12)  
NA  Occupant loads for each area  
NA  Exit access travel distance (107)  
NA  Common path of travel distance (Table 1006.2.1 + 1006.32(1))  
NA  NA  Dead end lengths (1000)  
NA  Clear exit width for each exit door  
NA  Maximum calculated occupant load capacity each exit door can accommodate based on egress width (1009.3)  
NA  Actual occupant load for each exit door  
NA  A separate schematic plan indicating where fire rated floor ceiling and/or roof structure is provided for purposes of occupancy separation  
NA  Location of doors with panic hardware (1010.10)  
NA  Location of doors with delayed egress locks and the amount of delay (1010.13.1)  
NA  Location of doors with electromagnetic egress locks (1010.13.3)  
NA  Location for doors equipped with hold-open devices  
NA  Location of emergency escape windows (1020)  
NA  The square footage of each fire area (C21)  
NA  The square footage of each smoke compartment for Occupancy Classification 1-2 (407B)  
NA  Note any code exceptions or table notes that may have been utilized regarding the items above

**ACCESSIBLE DWELLING UNITS (Section 1107)**

TOTAL UNITS	ACCESSIBLE UNITS REQUIRED	ACCESSIBLE UNITS PROVIDED	TYPE 'A' UNITS PROVIDED	TYPE 'B' UNITS PROVIDED	TYPE 'C' UNITS PROVIDED	TOTAL ACCESSIBLE UNITS PROVIDED

**ACCESSIBLE PARKING (Section 1106)**

LOT OR PARKING AREAS	TOTAL # OF PARKING SPACES REQUIRED	# OF ACCESSIBLE SPACES PROVIDED	REGULAR UNITS 8' ACCESSIBLE	VAN SPACES WITH 8' ACCESSIBLE	TOTAL NO. ACCESSIBLE UNITS PROVIDED

**PLUMBING FIXTURE REQUIREMENTS (Table 2902J)**

USE	WATER CLOSETS			URINALS			LAVATORIES			SHOWERS/TUBS			DRINKING FOUNTAINS	
	MALE	FEMALE	UNSEX	MALE	FEMALE	UNSEX	MALE	FEMALE	UNSEX	REGULAR	ACCESSIBLE	REGULAR	ACCESSIBLE	
OUTSIDE EXISTING														
NEW														
INSIDE EXISTING														
NEW	1 UNSEX IN BLDG. 'A'			1 UNSEX IN BLDG. 'A'										
REQUIRED	1 UNSEX IN BLDG. 'A'			1 UNSEX IN BLDG. 'A'										
PROVIDED	1 UNSEX IN BLDG. 'A'			1 UNSEX IN BLDG. 'A'										

Special approval: (Local Jurisdiction, Department of Insurance, OIG, DPI, DHHS, ICC, etc., describe below)

**ENERGY REQUIREMENTS**  
The following data shall be considered minimum and any special attributes required to meet the energy code shall also be provided. Each Designer shall furnish the required portions of the project information for the plan data sheet. If performance method, state the annual energy cost standard reference design vs annual energy cost for the proposed design.

**Climate Zone**  3  4  5

**Method of Compliance**  
 Prescriptive (Energy Code)  
 Performance (Energy Code)  
 Prescriptive (ASHRAE 90.1)  
 Performance (ASHRAE 90.1)

**THERMAL ENVELOPE**

**Roof/Ceiling Assembly (each assembly)**  
Description of assembly: \_\_\_\_\_  
U-Value of total assembly: \_\_\_\_\_  
R-Value of insulation: \_\_\_\_\_  
Skylights in each assembly: \_\_\_\_\_  
U-Value of skylight: \_\_\_\_\_  
Total square footage of skylights in each assembly: \_\_\_\_\_

**Exterior Walls (each assembly)**  
Description of assembly: \_\_\_\_\_  
U-Value of total assembly: \_\_\_\_\_  
R-Value of insulation: \_\_\_\_\_  
Openings (e.g., doors with glazing): \_\_\_\_\_  
U-Value of total assembly: \_\_\_\_\_  
Door R-Values: \_\_\_\_\_

**Walls below grade (each assembly)**  
Description of assembly: \_\_\_\_\_  
U-Value of total assembly: \_\_\_\_\_  
R-Value of insulation: \_\_\_\_\_  
Horizontal/vertical requirement: \_\_\_\_\_  
slab rested: \_\_\_\_\_

**Floors over unconditioned space (each assembly)**  
Description of assembly: \_\_\_\_\_  
U-Value of total assembly: \_\_\_\_\_  
R-Value of insulation: \_\_\_\_\_

**Floors slab on grade**  
Description of assembly: \_\_\_\_\_  
U-Value of total assembly: \_\_\_\_\_  
R-Value of insulation: \_\_\_\_\_  
Horizontal/vertical requirement: \_\_\_\_\_  
slab rested: \_\_\_\_\_

**UNIT MIX - TOTAL 4 BLDG.**

SIZE	MARK	A	B	C	J	TOTAL	ACCESSIBLE UNITS
5'x5'	A	4	-	-	-	66	BLDG. A 5
5'x10'	B	13	6	8	-	81	
10'x10'	G	105	-	-	3	183	
10'x15'	H	24	52	-	-	88	
10'x20'	I	16	-	60	-	88	
10'x30'	K	-	-	-	26	44	BLDG. J 3
12'x30'	Z	-	-	-	15	30	
TOTAL		162	58	68	44	332	13

NET SQ. FT. PER BLDG.	18,284	8,100	12,400	13,500	52,284 SQ. FT. NET TOTAL
GROSS SQ. FT. PER BLDG.	23,508	8,100	12,400	13,500	57,508 SQ. FT. GROSS TOTAL

**UNIT CALCULATIONS**

CODE REQUIREMENTS	PERCENTAGE	# OF UNITS	# OF ADA UNITS REQ.
5% OF THE FIRST 200 UNITS	5%	200	10
2% OF REMAINING UNITS	2%	132	2.64
TOTAL		332	3

NOTE: ALL ACCESSIBLE STORAGE UNITS DOORS SHALL HAVE A MAX. 5 LB. FULL

REVISIONS BY

DRAWN BY: VJS  
CHECKED BY: RHE  
DATE: 07-29-2022  
SCALE: 1/16" = 1'-0"  
FILE:  
SHEET NUMBER: COVER BLDG. A

THESE DRAWINGS ARE INSTRUMENTS OF SERVICE AND SHALL REMAIN THE PROPERTY OF THE ARCHITECT. THESE DRAWINGS ARE NOT TO BE REPRODUCED IN ANY MANNER WITHOUT THE SPECIFIC WRITTEN CONSENT OF THE ARCHITECT.

© 2016 ERSKINE-SMITH ARCHITECTURE, PLLC

**ERSKINE-SMITH ARCHITECTURE**  
 architecture research planning  
 3406-A West Wendover Avenue  
 Greensboro, N.C. 27407  
 Phone (336) 855-1286 Fax 855-5602

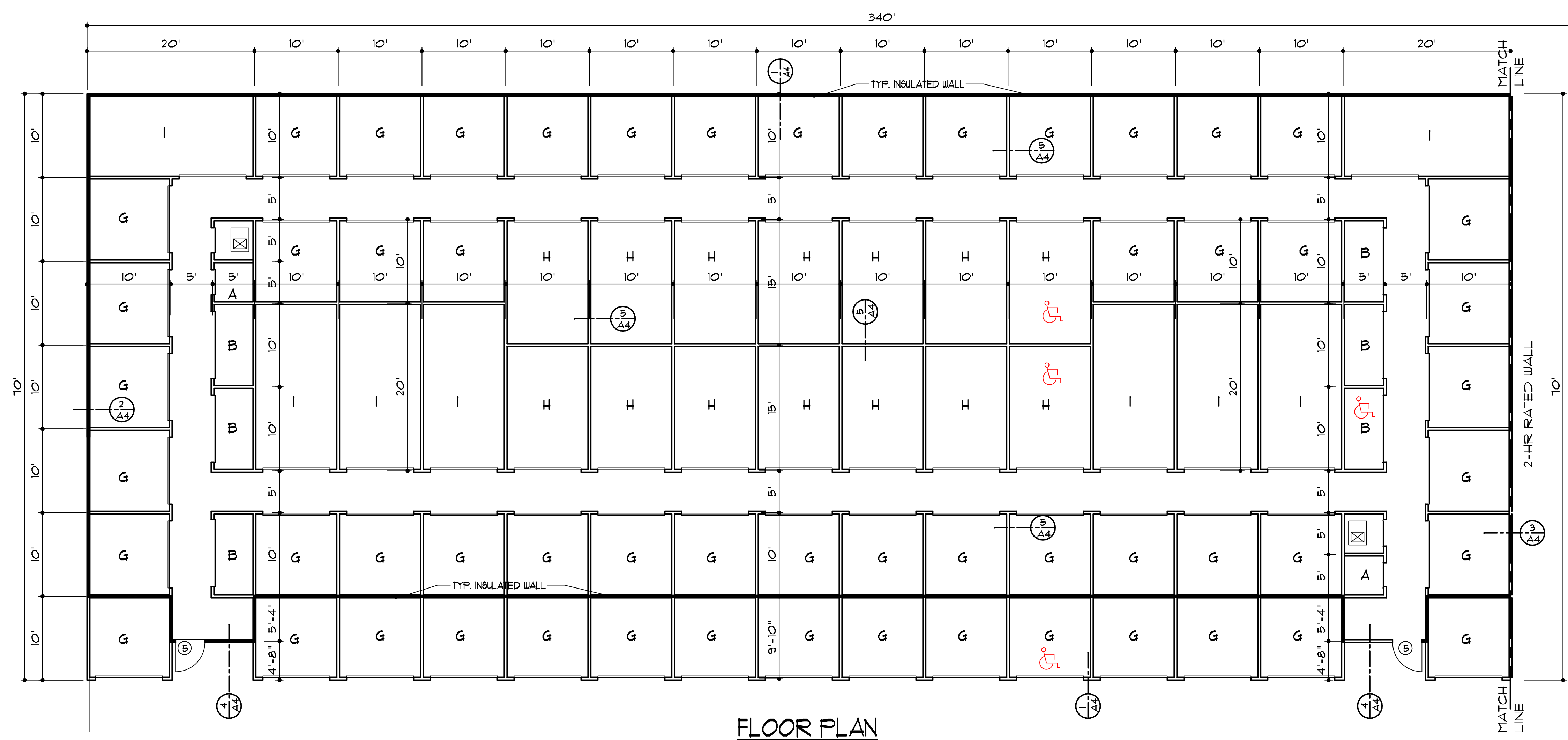
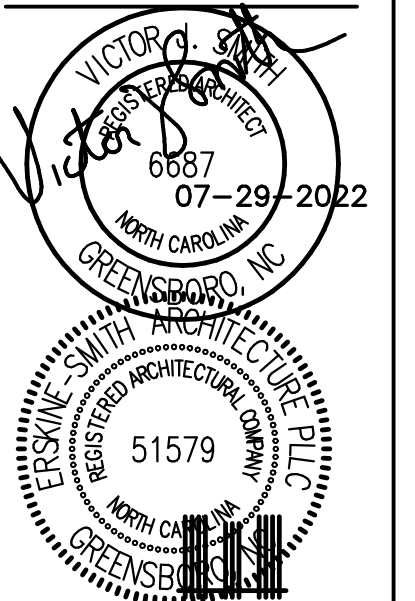

**FLOOR PLAN**  
 1/8" = 1'-0"

DOOR SCHEDULE						
MARK	QUANTITY	UNIT SIZE	MATERIAL	GLAZING	FRAME	HARDWARE
1	1	3'-0" x 7'-0" x 13/4"	ALUM. STOREFRONT	FULL LITE	ALUM.	PUSH / PULL W/ LOCK SET, 1/2 PR BUTT HINGE, SILENCERS, DOOR STOP, CLOSER
2	2	3'-0" x 7'-0" x 13/4"	SOLID CORE BIRCH/VN/A		16 GA. METAL	LEVER HANDLE LOCK SET, 1/2 PR BUTT HINGE, SILENCERS, DOOR STOP
3	1	3'-0" x 7'-0" x 13/4"	SOLID CORE BIRCH/VN/A		16 GA. METAL	LEVER HANDLE PASSAGE SET, 1/2 PR BUTT HINGE, SILENCERS, DOOR STOP
4	1	3'-0" x 7'-0" x 13/4"	SOLID CORE METAL/VN/A		16 GA. METAL	LEVER HANDLE LOCK SET, 1/2 PR BUTT HINGE, DOOR STOP, 1/2 HC THRESHOLD, CLOSER, (20 MIN. ASSEMBLY)
5	4	3'-6" x 7'-0" x 13/4"	INSUL. METAL	6"x30" VISION PANEL	16 GA. METAL	LEVER HANDLE LOCK SET, 2 PR BUTT HINGE, SILENCERS CLOSER, 1/2 HC THRESHOLD, WEATHER-STRIPPING

NOTE: 1. ALL INTERIOR OVERHEAD DOORS BY "METAL BUILDING COMPANY"

WINDOW SCHEDULE						
MARK	QUANTITY	UNIT SIZE	MATERIAL	GLAZING	FRAME	HARDWARE
A	1	15'-10" x 8'-0"	ALUM. STOREFRONT	FULL LITE	ALUM.	ALUM. STOREFRONT W/ 1" LOW-E INSUL. GLASS WITH DOOR #1
B	4	6'-6" x 8'-0"	ALUM. STOREFRONT	FULL LITE	ALUM.	ALUM. STOREFRONT W/ 1" LOW-E INSUL. GLASS
C	1	9'-7" x 8'-0"	ALUM. STOREFRONT	FULL LITE	ALUM.	ALUM. STOREFRONT W/ 1" LOW-E INSUL. GLASS

UNIT MIX - TOTAL 4 BLDG.							
SIZE	MARK	BUILDING TYPE				TOTAL	ACCESSIBLE UNITS
		A	B	C	J		
5'x5'	A	4	-	-	-	66	BLDG. A 5
5'x10'	B	13	6	8	-	81	
10'x10'	G	105	-	-	3	51	BLDG. A 5
10'x15'	H	24	52	-	-	183	
10'x20'	I	16	-	60	-	88	BLDG. J 3
10'x30'	K	-	-	-	26	44	
12'x30'	Z	-	-	-	15	30	
TOTAL		162	58	68	44	332	
NET SQ. FT. PER BLDG.		18,284	8,100	12,400	13,500	55,284	SQ. FT. NET TOTAL
GROSS SQ. FT. PER BLDG.		23,508	8,100	12,400	13,500	57,508	SQ. FT. GROSS TOTAL

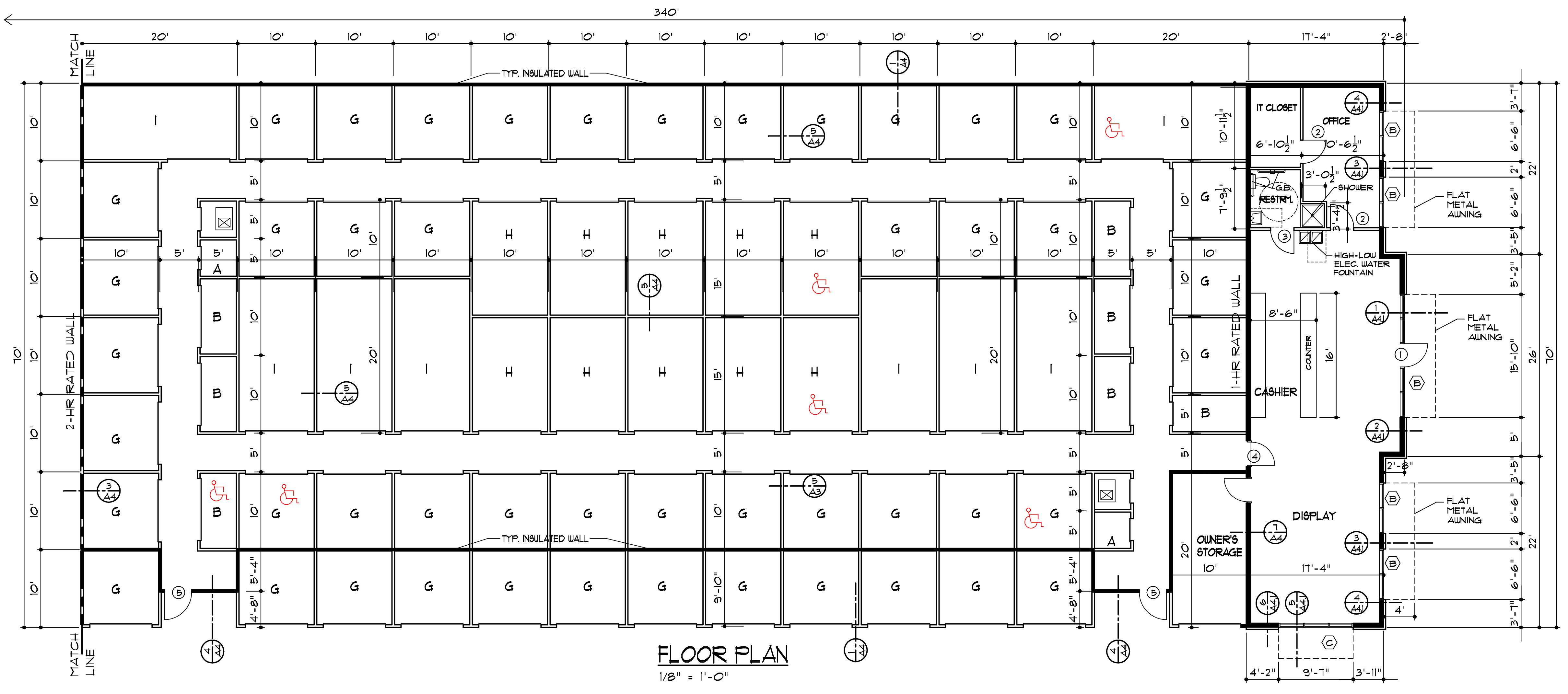

**FLOOR PLAN**  
 1/8" = 1'-0"

NOTE:  
 ADA UNITS WILL INCLUDE AN ELECTRIC DOOR LIFT OPERATOR WITH BATTERY BACKUP, PHOTO EYES, EMERGENCY RELEASE AND KEYPAD FOR OPERATION. KEYPAD WILL BE MOUNTED WITHIN ACCESSIBLE REACH RANGES PER ANSI 308. MANUFACTURER: LIFT MASTER 8950W OR EQUAL

HORIZONTAL SLIDING DOORS SHALL COMPLY WITH SECTION 1010.1.43 OF NCBC. ELECTRICAL TO BE COORDINATED.

OCCUPANT DISPERSAL FROM EXITS TO PUBLIC ROAD SHOWN ON SITE PLAN

NOTE:  
 1. EXTERIOR WALL DIMENSIONS TAKEN FROM EXTERIOR FACE OF STUD  
 2. INTERIOR WALL DIMENSIONS TAKEN FROM CENTER LINE OF WALL  
 3. OVERHEAD DOORS FOR STORAGE UNITS SUPPLIED AND SIZED BY METAL BLDG. MANUFACTURER  
 4. EXTERIOR WALLS TO BE INSULATED EXCEPT AT EXTERIOR STORAGE UNITS  
 5. WALL BETWEEN EXTERIOR ENTRANCE STORAGE UNITS AND INTERIOR STORAGE UNITS TO BE INSULATED.  
 6. WALLS BETWEEN OFFICE & STORAGE AREA TO BE INSULATED  
 7. PROVIDE BLOCKING BEHIND SINK, TOILET, WATER FOUNTAIN & SHOWER  
 8. SHOWER UNIT TO BE ACCESSIBLE TYPE WITH 1/2" THRESHOLD & GRAB BARS

**BUILDING 1/A**

**BLDG. A**

**NEW STORAGE FACILITY FOR HARNETT SELF STORAGE SPOUT SPRINGS, NC**

REVISIONS	BY

DRAWN BY: VJS  
 CHECKED BY: VJS  
 DATE: 07-29-2022  
 SCALE: 1/8" = 1'-0"  
 FILE:  
 SHEET NUMBER:

A-1

THESE DRAWINGS ARE INSTRUMENTS OF SERVICE AND SHALL REMAIN THE PROPERTY OF THE ARCHITECT. THESE DRAWINGS ARE PROTECTED UNDER COPYRIGHT LAWS AND MAY NOT BE REPRODUCED IN PART OR IN WHOLE WITHOUT THE SPECIFIC WRITTEN CONSENT OF THE ARCHITECT.  
 © 2016 ERSKINE-SMITH ARCHITECTURE, PLLC

**ERSKINE-SMITH ARCHITECTURE**  
 architecture research planning  
 3406-A West Wendover Avenue  
 Greensboro, N.C. 27407  
 Phone (336) 855-1286 Fax 855-5602

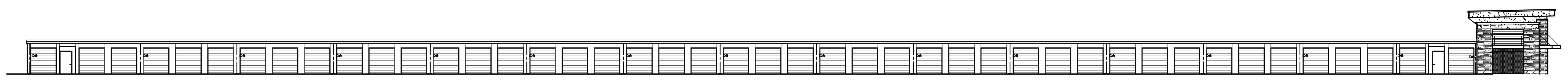

**EAST ELEVATION**  
 1/16" = 1'-0"

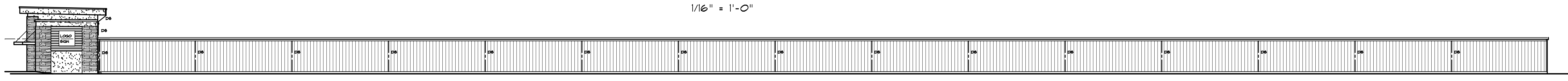

**WEST ELEVATION**  
 1/16" = 1'-0"

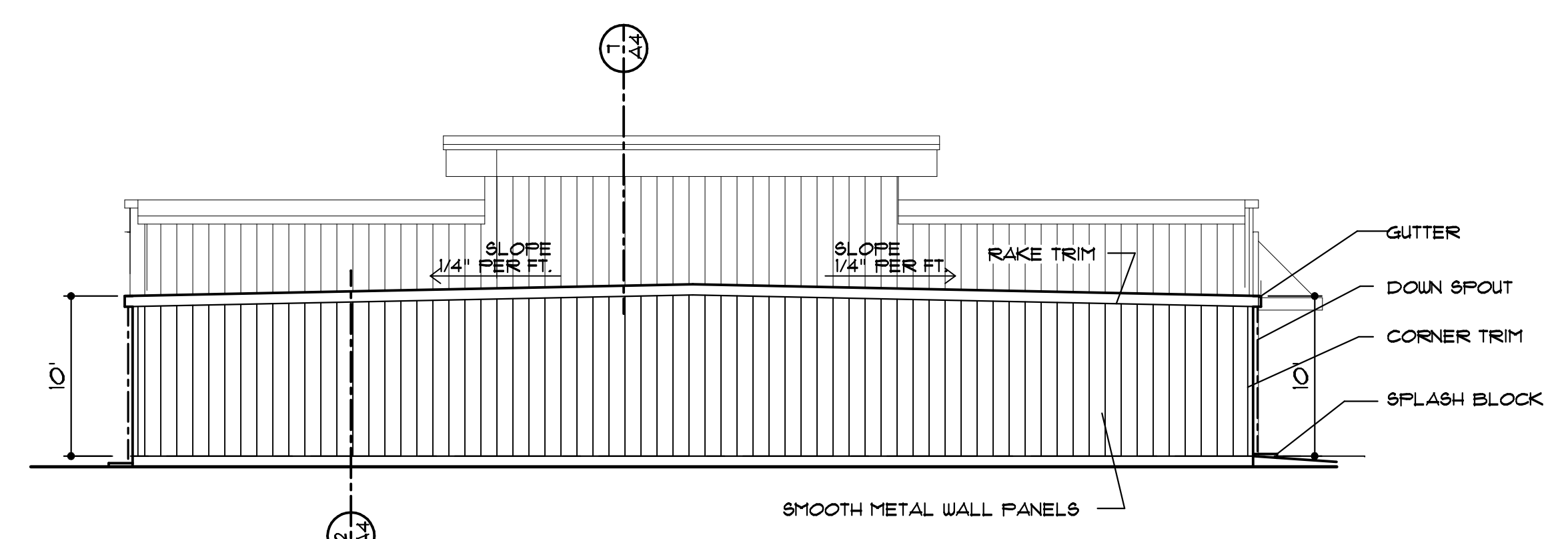

ALL RAIN LEADER TO HAVE SPLASH BLOCKS

**DOWN SPOUTS & GUTTERS**  
 ROOF AREA = 13,500 SF  
 GUTTER LENGTH = 450' LF  
 GUTTER SIZE = 5" w X 4" d  
 # DOWN SPOUT (3" x 4") = 16  
 AREA PER DOWN SPOUT = 844 sf

**SOUTH ELEVATION**  
 1/8" = 1'-0"

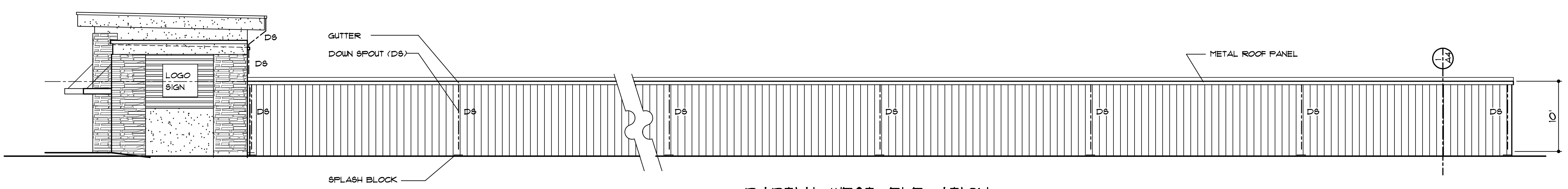

**PARTIAL WEST ELEVATION**  
 1/8" = 1'-0"

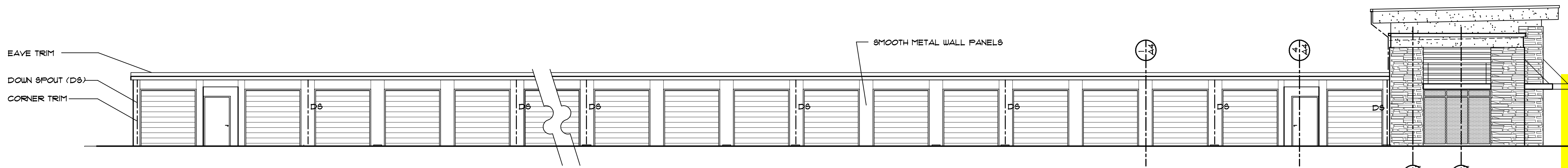

**PARTIAL EAST ELEVATION**  
 1/8" = 1'-0"

NOTE: SEE SHEET A-3 FOR ADDITIONAL NOTES AND DIMENSIONS

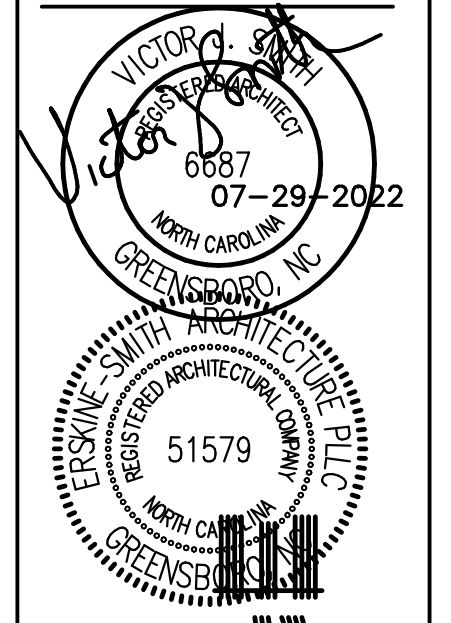

**NEW STORAGE FACILITY FOR HARNETT SELF STORAGE**  
 SPOUT SPRINGS, NC

REVISIONS	BY

DRAWN BY: VJS  
 CHECKED BY: VJS  
 DATE: 07-29-2022  
 SCALE: 1/8" = 1'-0"  
 FILE:  
 SHEET NUMBER:

**BLDG. A**

**A-2**

THESE DRAWINGS ARE INSTRUMENTS OF SERVICE AND SHALL REMAIN THE PROPERTY OF THE ARCHITECT. THESE DRAWINGS ARE PROTECTED UNDER COPYRIGHT LAWS AND MAY NOT BE REPRODUCED IN PART OR IN WHOLE WITHOUT THE SPECIFIC WRITTEN CONSENT OF THE ARCHITECT.  
 ©2016 ERSKINE-SMITH ARCHITECTURE, PLLC

**ERSKINE-SMITH ARCHITECTURE**  
 architecture research planning  
 3405-A West Wendover Avenue  
 Greensboro, N.C. 27407  
 Phone (336) 855-1286 Fax 855-5602

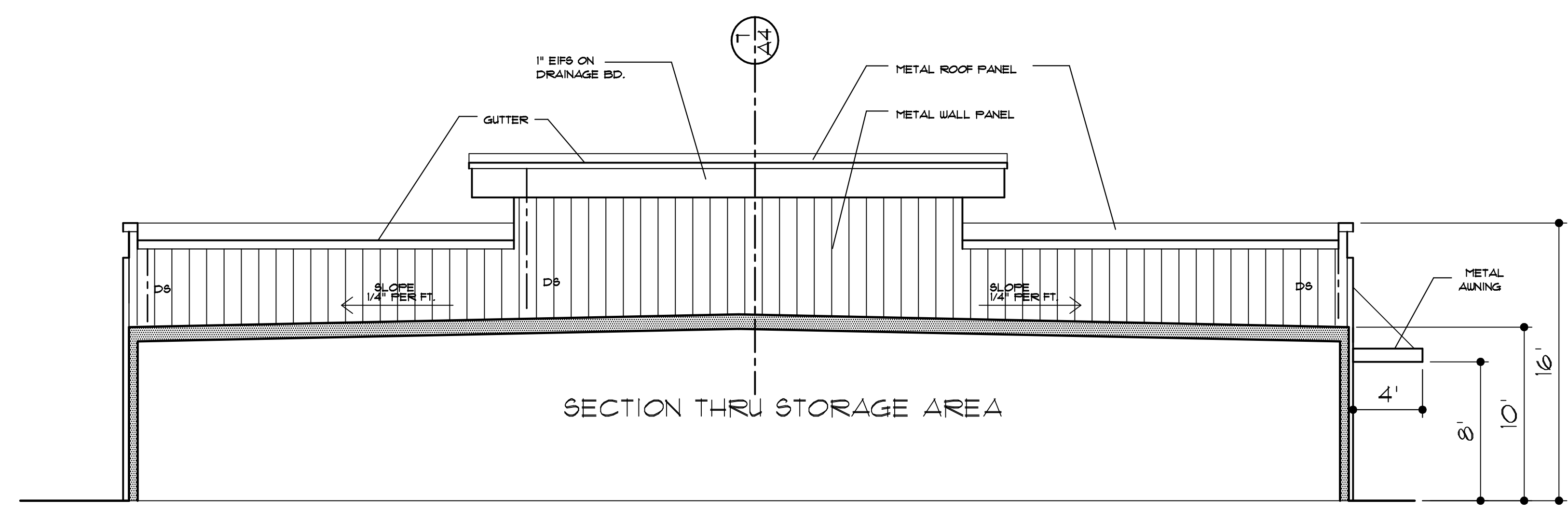
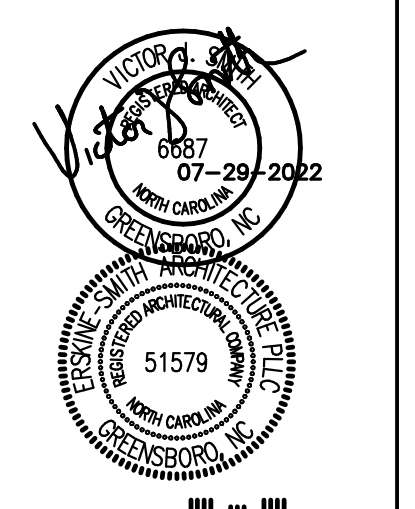

SOUTH ELEVATION

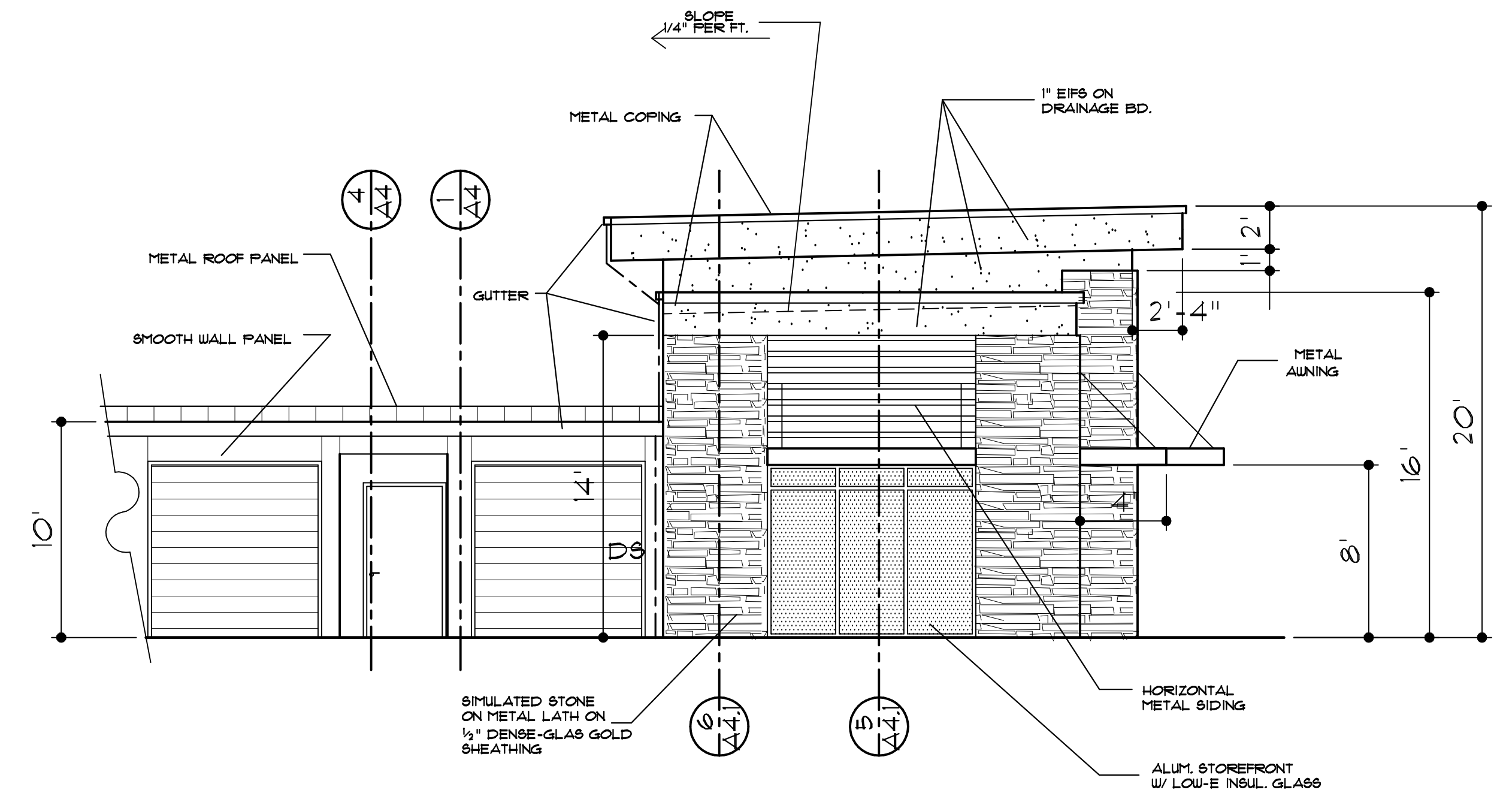

EAST ELEVATION

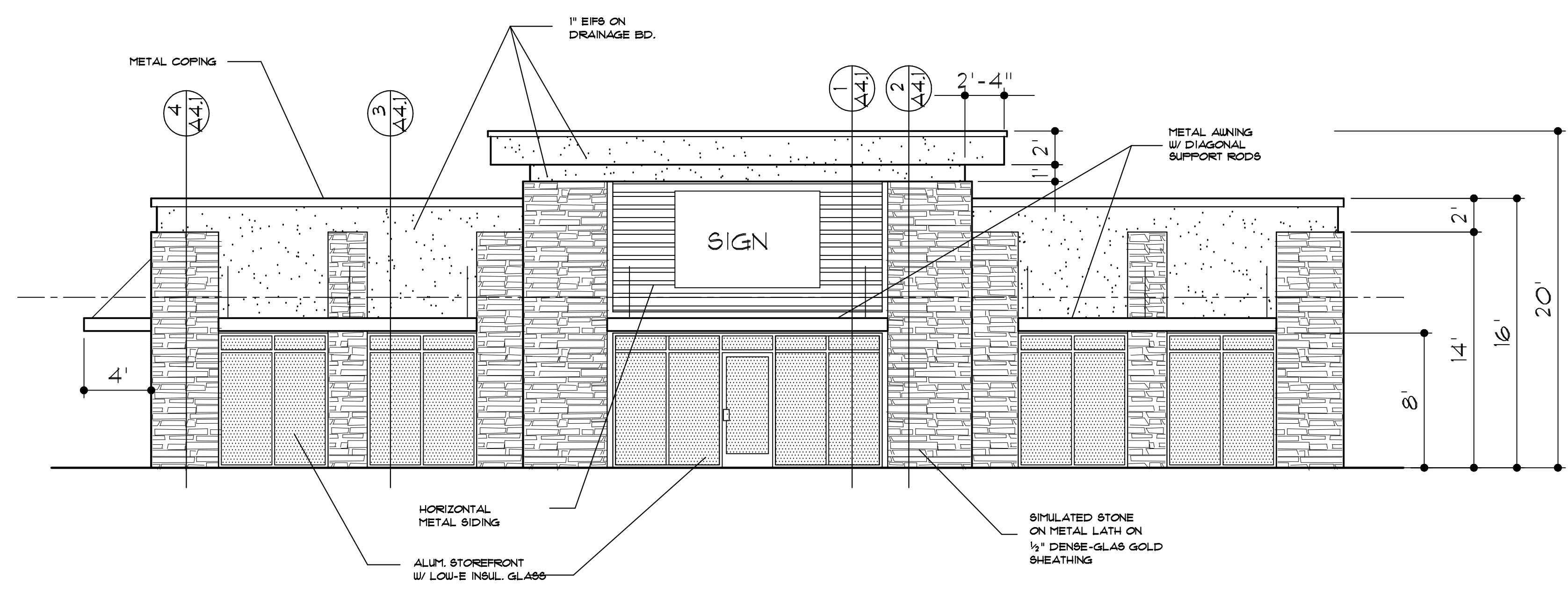

NORTH ELEVATION

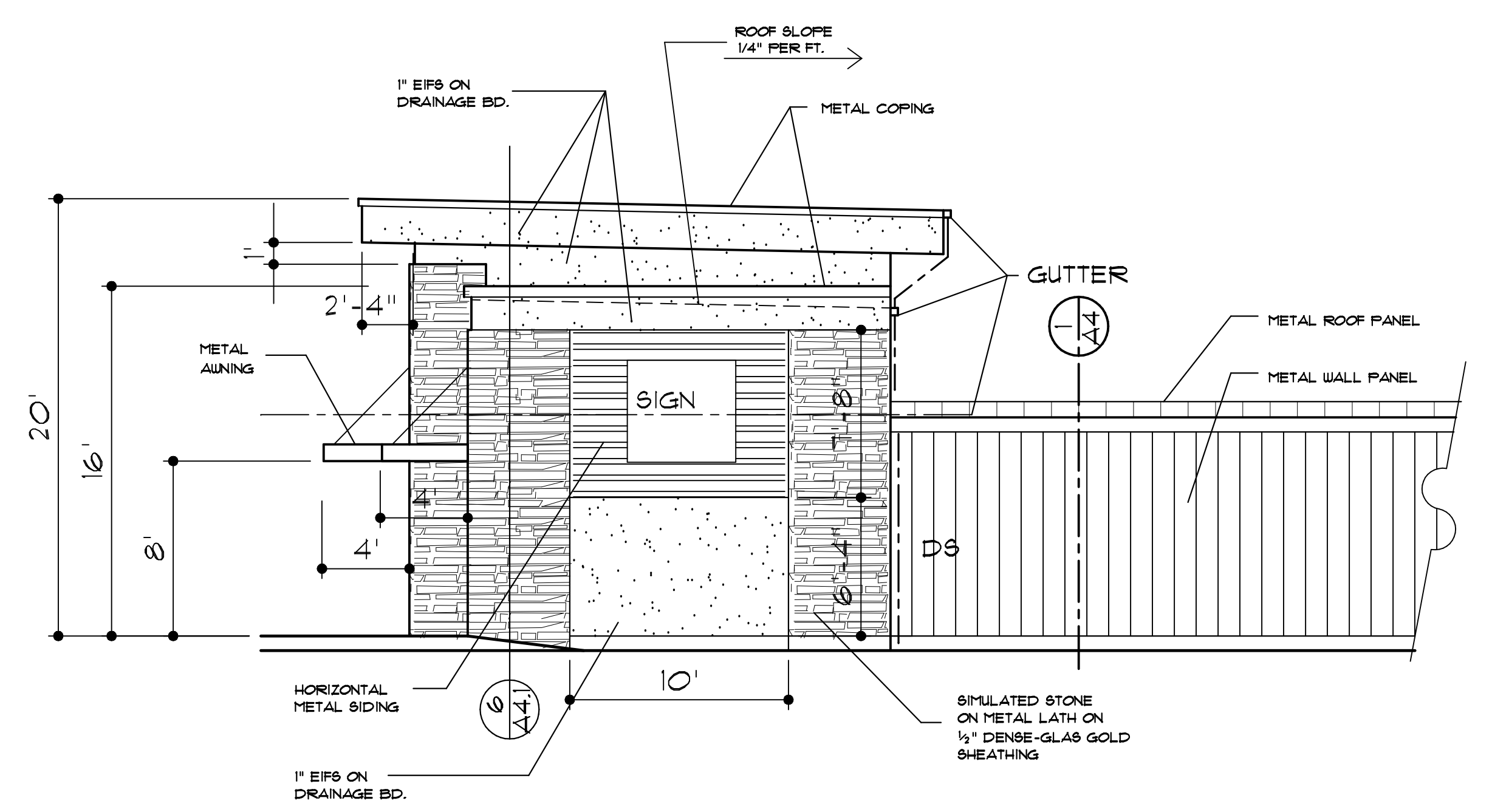

WEST ELEVATION

**NEW STORAGE FACILITY FOR  
 HARNETT SELF STORAGE**  
 SPOUT SPRINGS, NC

REVISIONS	BY

DRAWN BY : VJS  
 CHECKED BY : VJS  
 DATE : 07-29-2022  
 SCALE : 3/16" = 1'-0"  
 FILE :  
 SHEET NUMBER :

**BLDG. A**

**A-3**

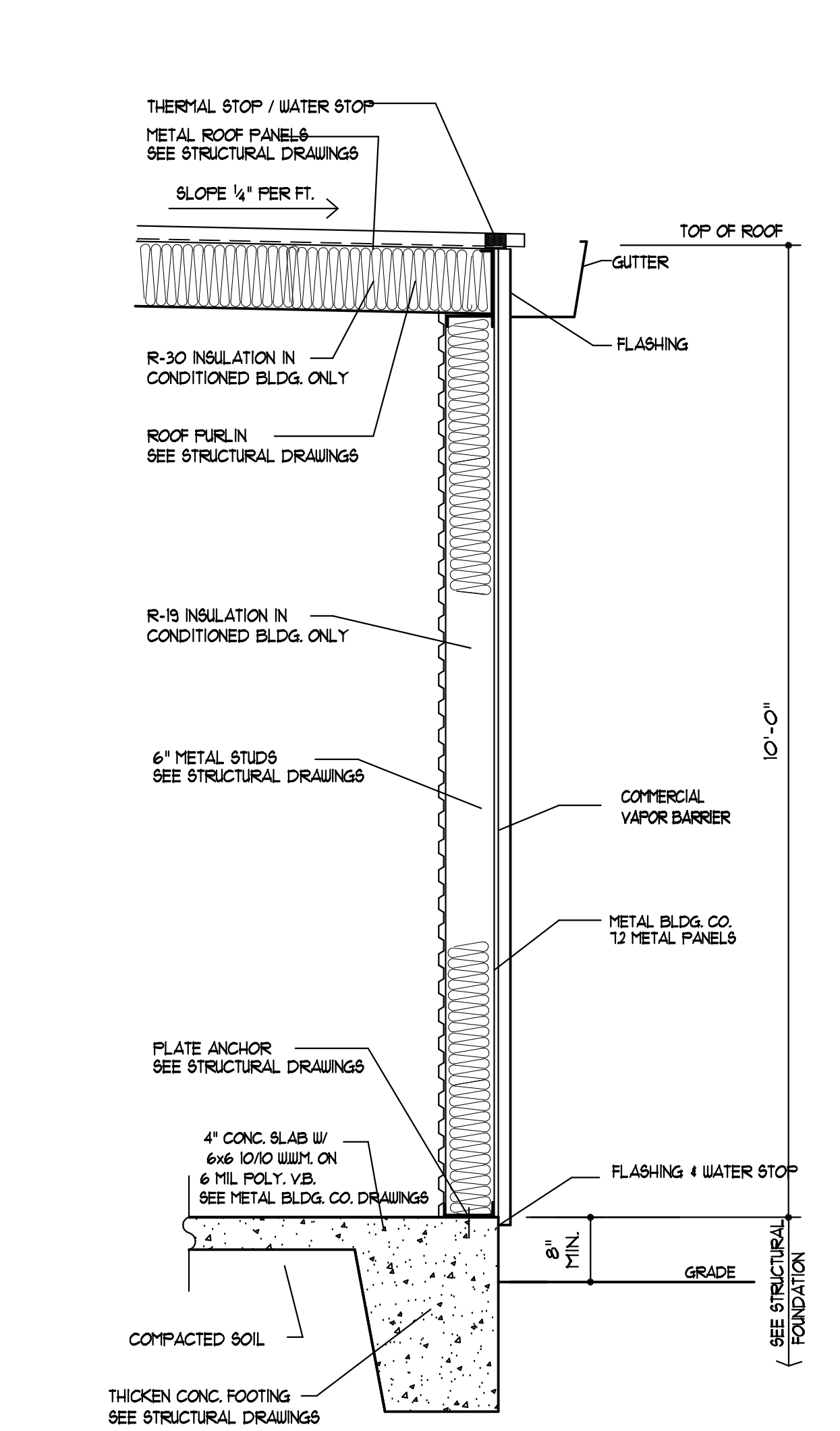
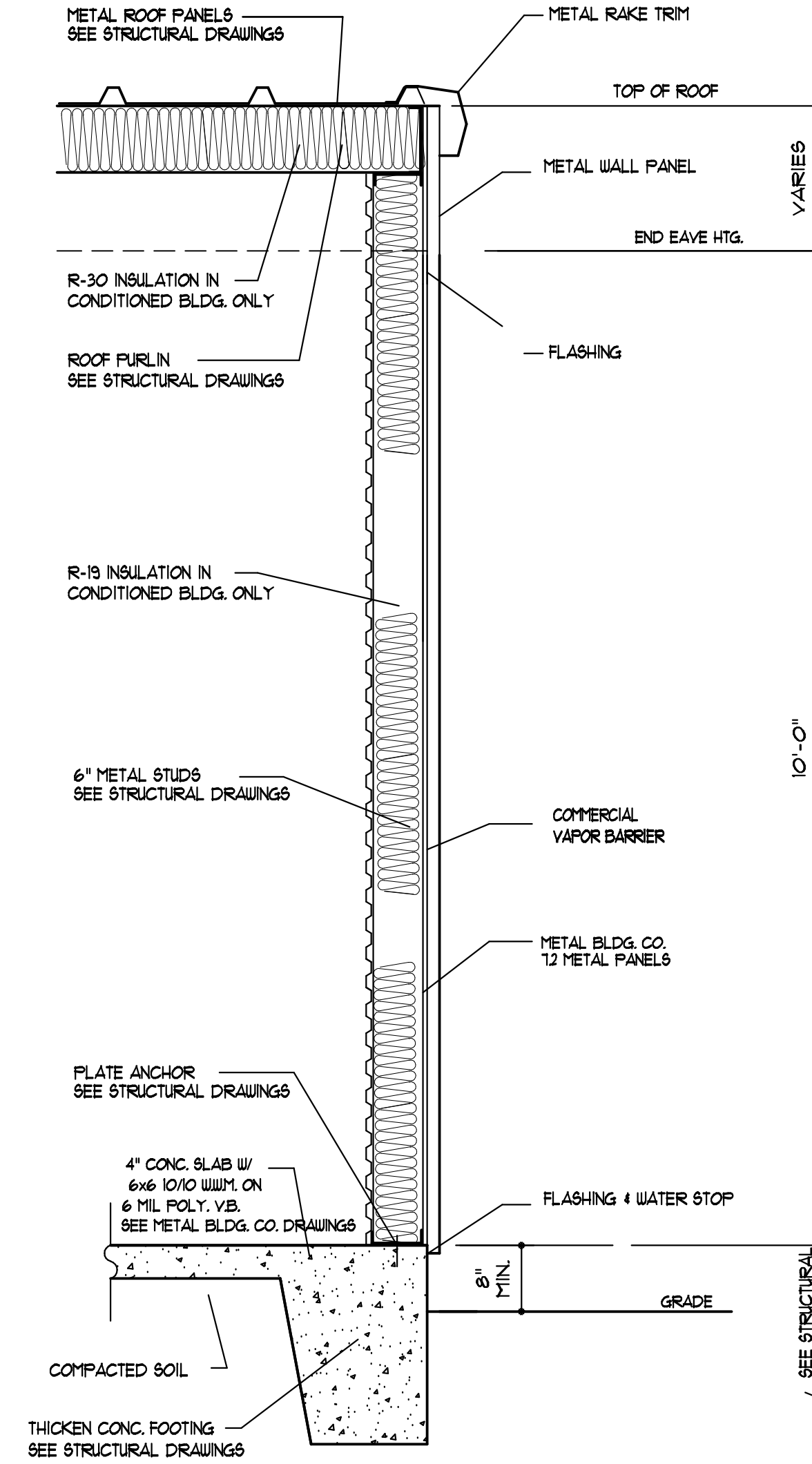
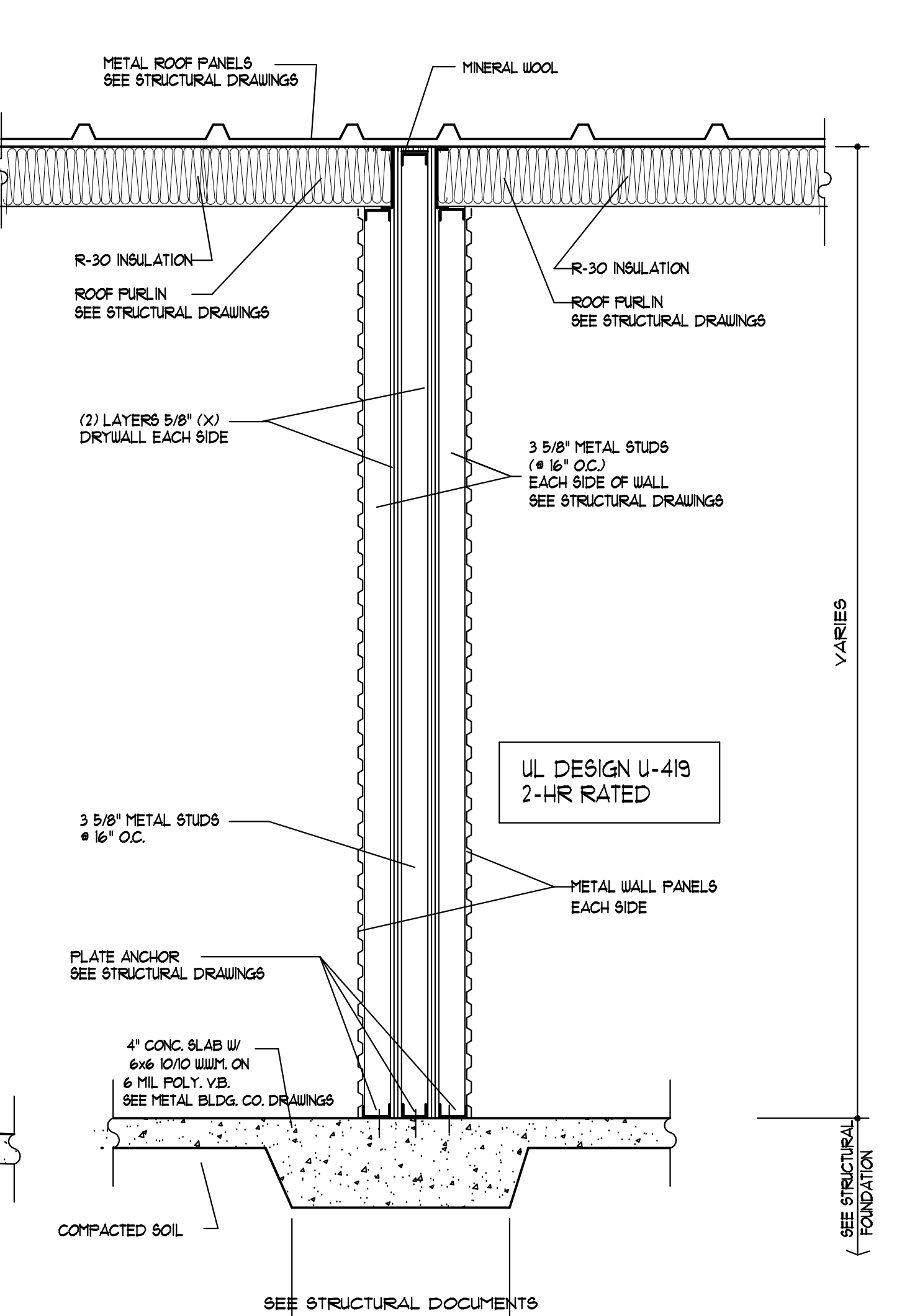
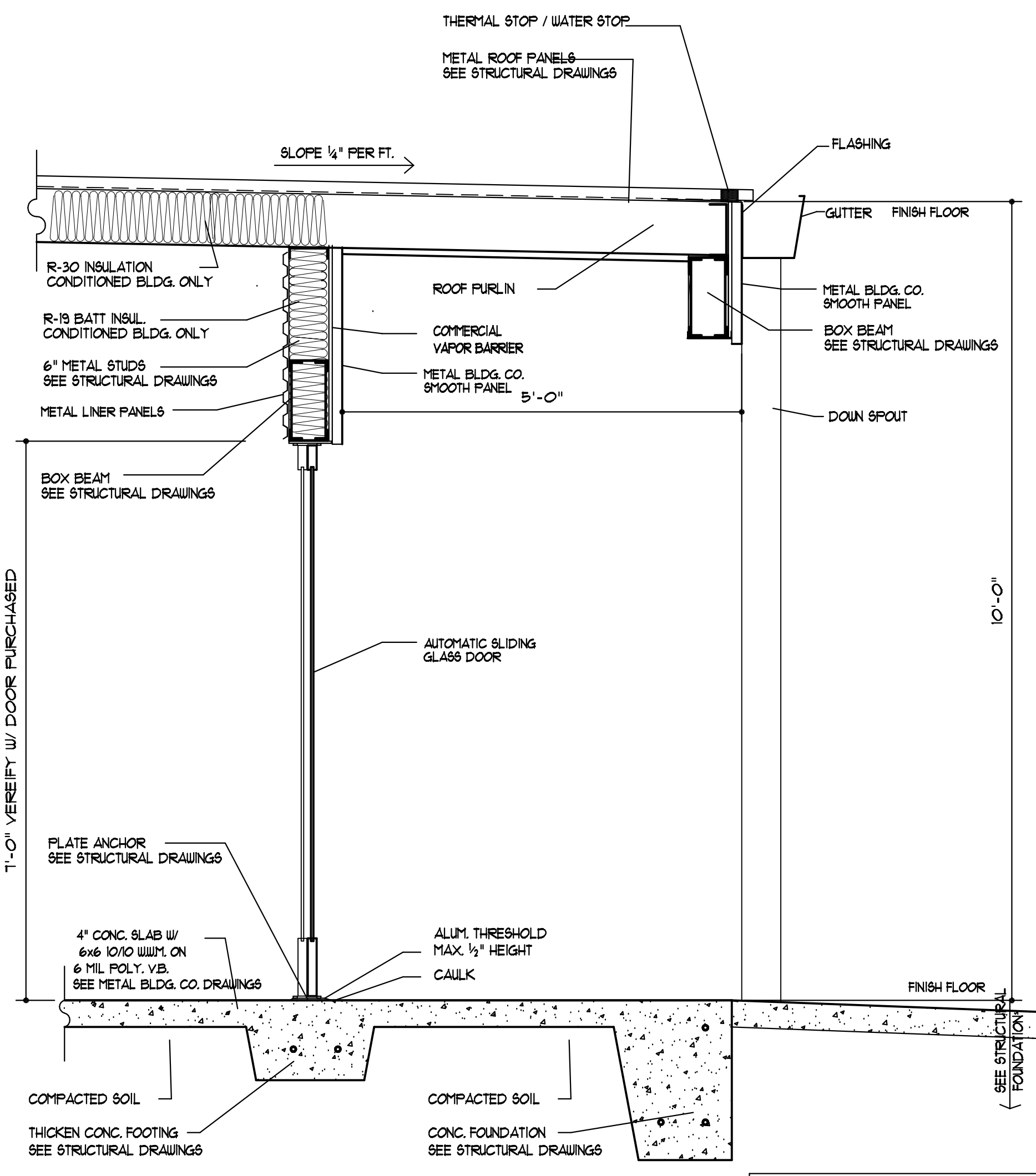
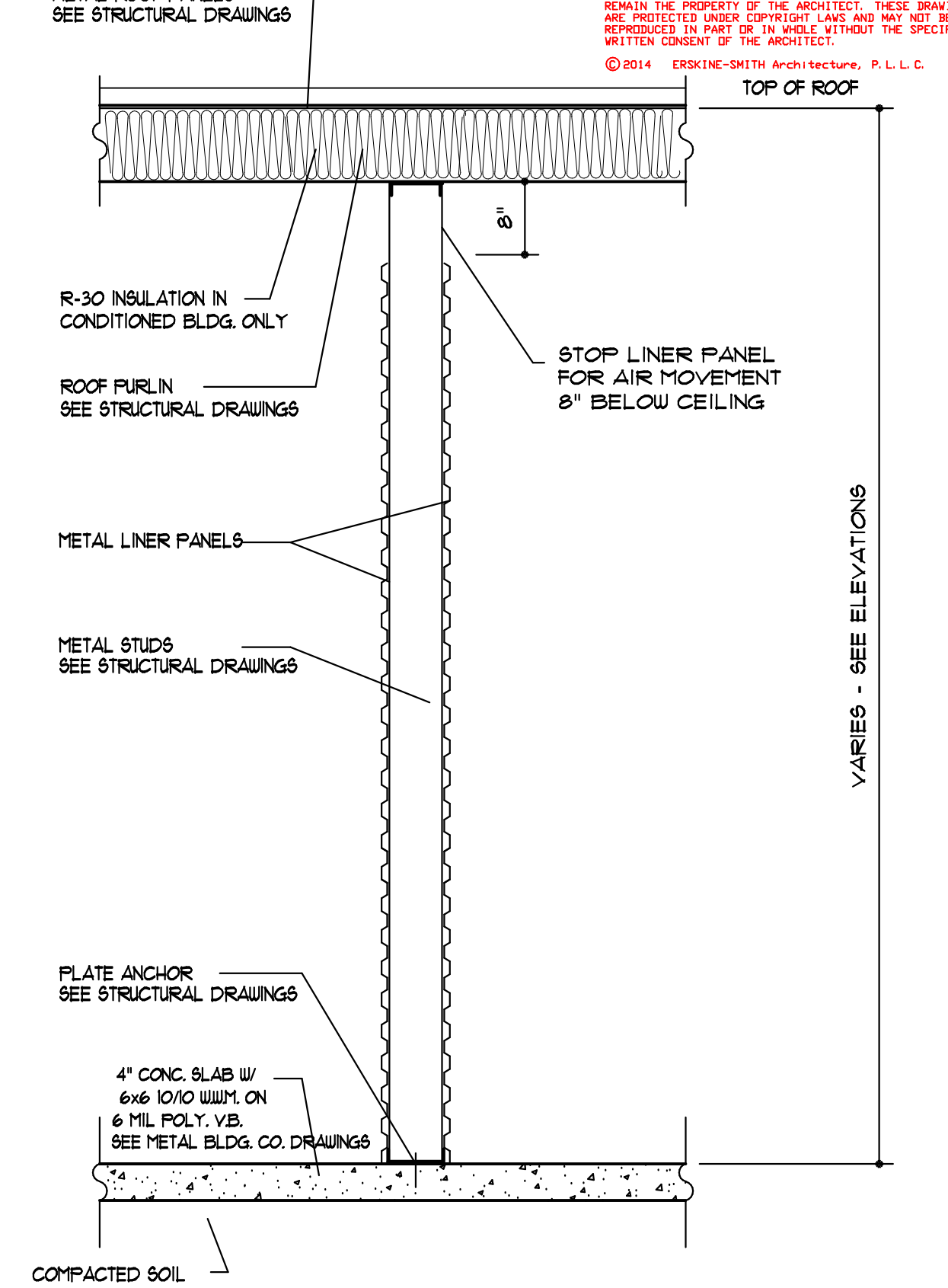
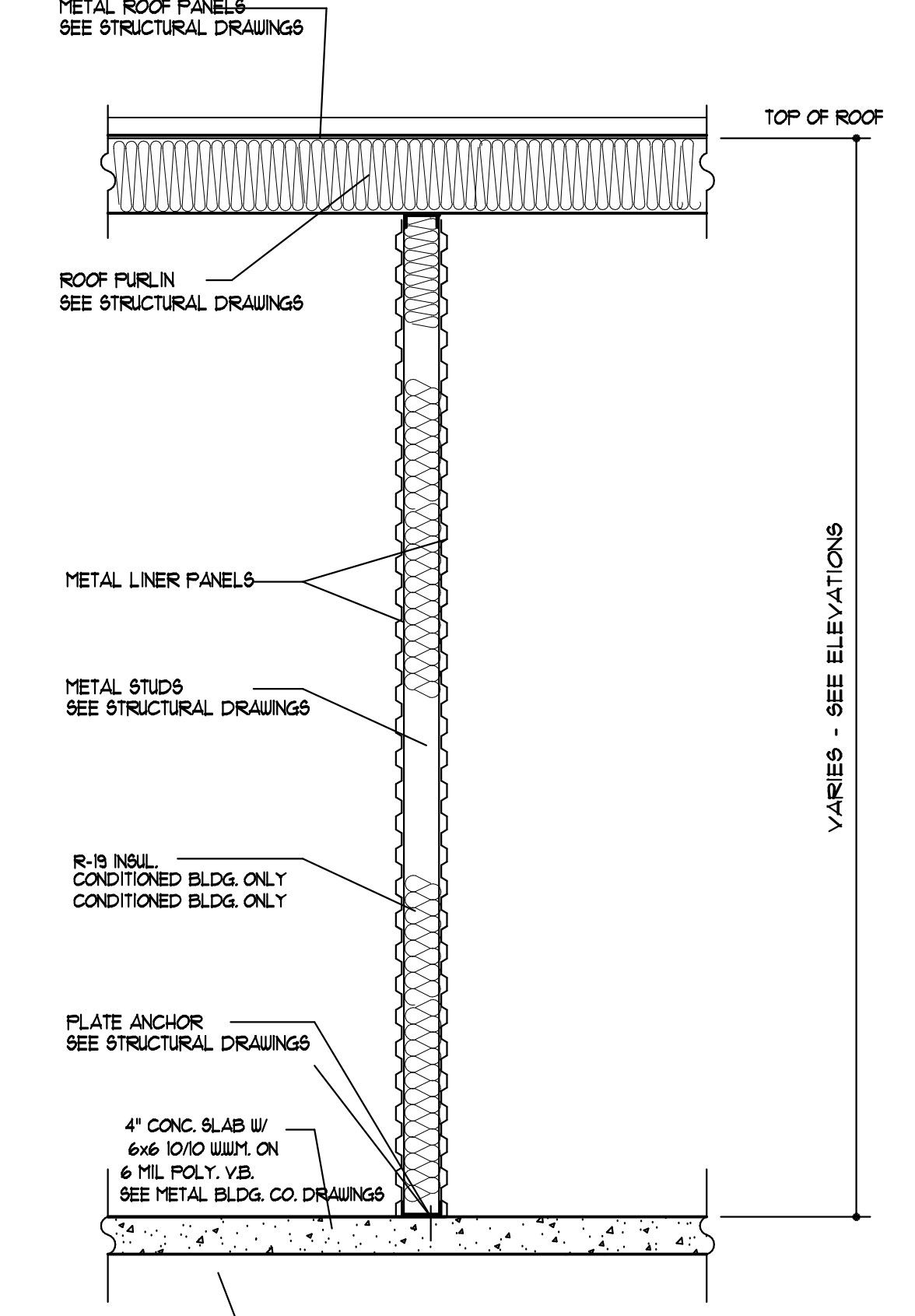
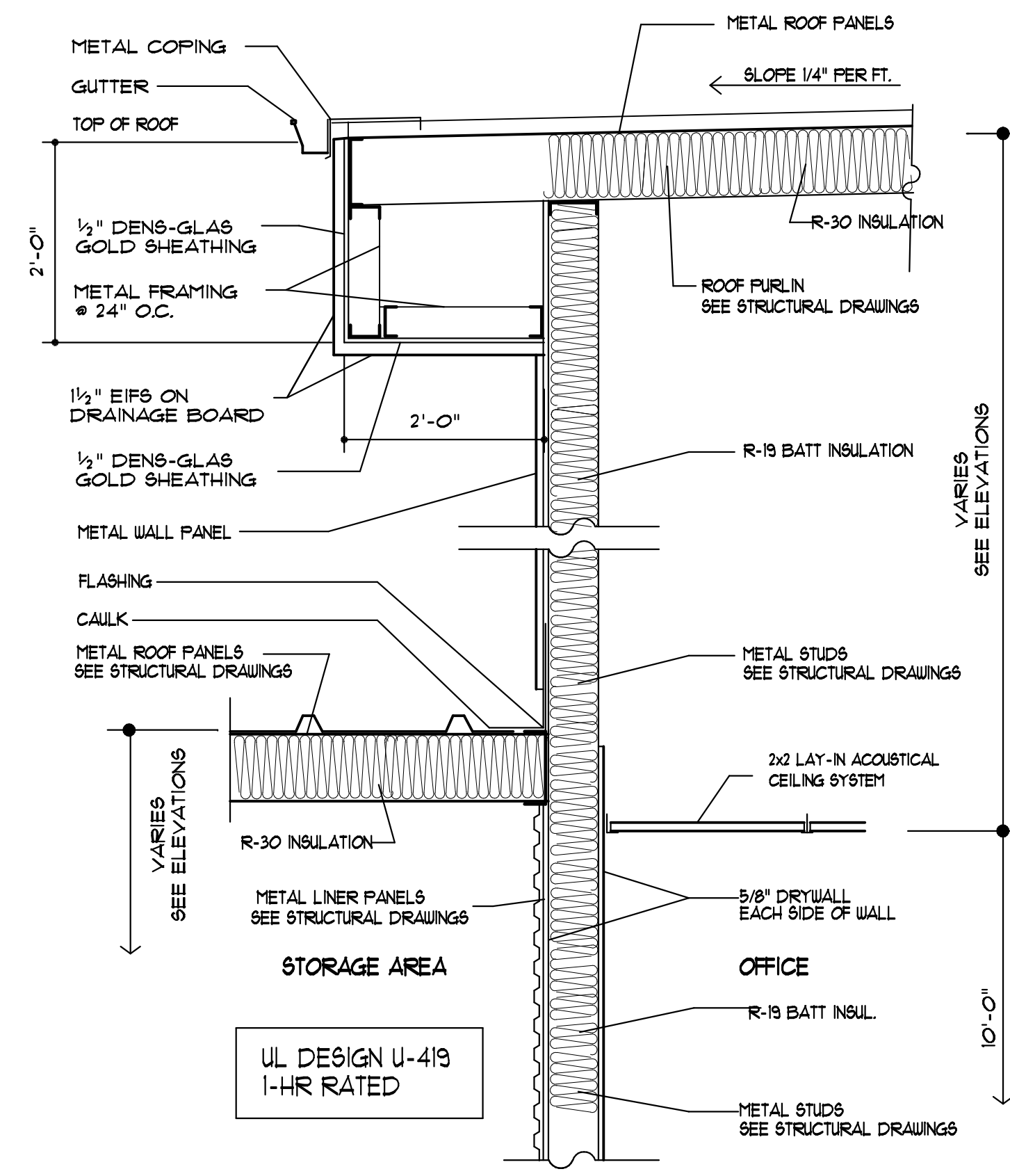

NOTE: STRUCTURAL ENGINEERS DESIGN & DETAILS SHALL OVERRIDE ARCHITECTURAL DETAILS

NOTE: DO NOT SCALE DRAWINGS PDF & PRINTING CHANGES PLEASE

**ERSKINE-SMITH ARCHITECTURE, P.L.L.C.**  
 architecture research planning  
 3406-A West Wendover Avenue  
 Greensboro, N.C. 27407  
 Phone (336) 855-1286 Fax 855-5602

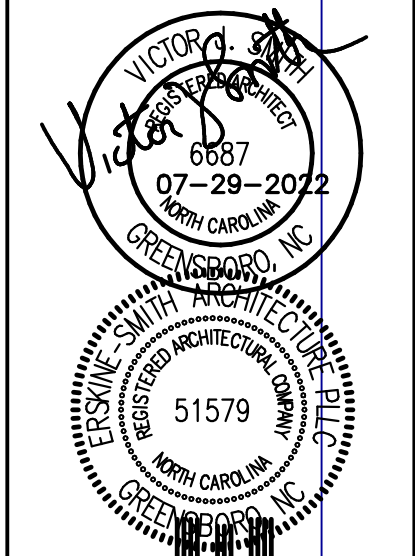

NEW STORAGE FACILITY FOR  
**HARNETT SELF STORAGE**  
 SPOUT SPRINGS, NC

REVISIONS	BY

DRAWN BY: VJS  
 CHECKED BY: VJS  
 DATE: 07-29-2022  
 SCALE: 3/4" = 1'-0"  
 FILE:

SHEET NUMBER:  
**A-3**  
 BLDG. 'A'

THESE DRAWINGS ARE INSTRUMENTS OF SERVICE AND SHALL REMAIN THE PROPERTY OF THE ARCHITECT. THESE DRAWINGS ARE PROTECTED UNDER COPYRIGHT LAWS AND MAY NOT BE REPRODUCED IN PART OR IN WHOLE WITHOUT THE SPECIFIC WRITTEN CONSENT OF THE ARCHITECT.  
© 2014 ERSKINE-SMITH ARCHITECTURE, P.L.L.C.

**ERSKINE-SMITH ARCHITECTURE, P.L.L.C.**  
architecture research planning  
3406-A West Wendover Avenue  
Greensboro, N.C. 27407  
Phone (336) 855-1286 Fax 855-5602

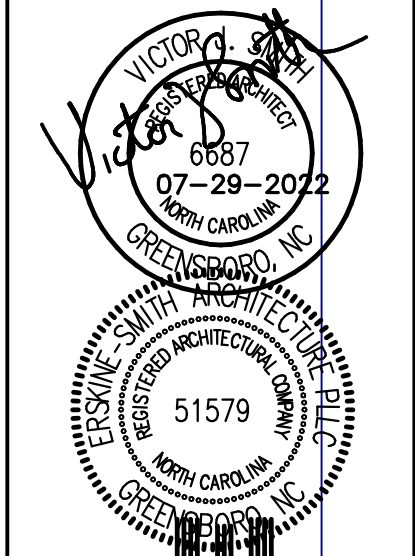

**NEW STORAGE FACILITY FOR HARNETT SELF STORAGE**  
SPOUT SPRINGS, NC

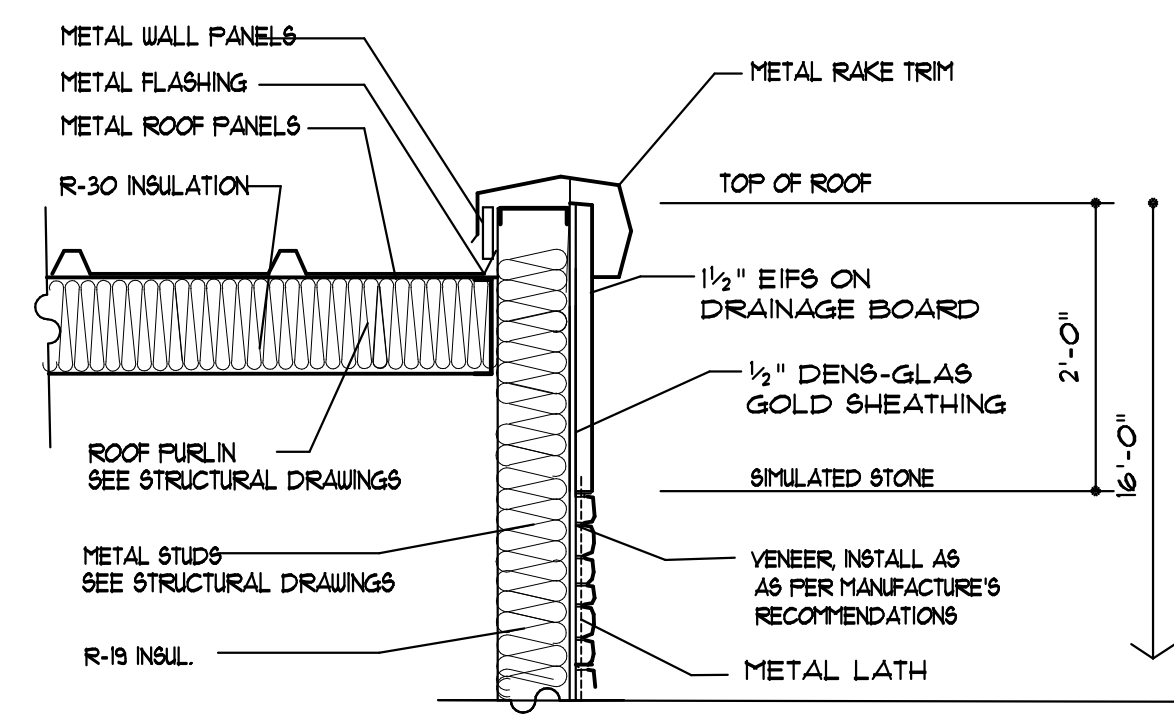

6 TYP. EXTERIOR END WALL  
A-4.1

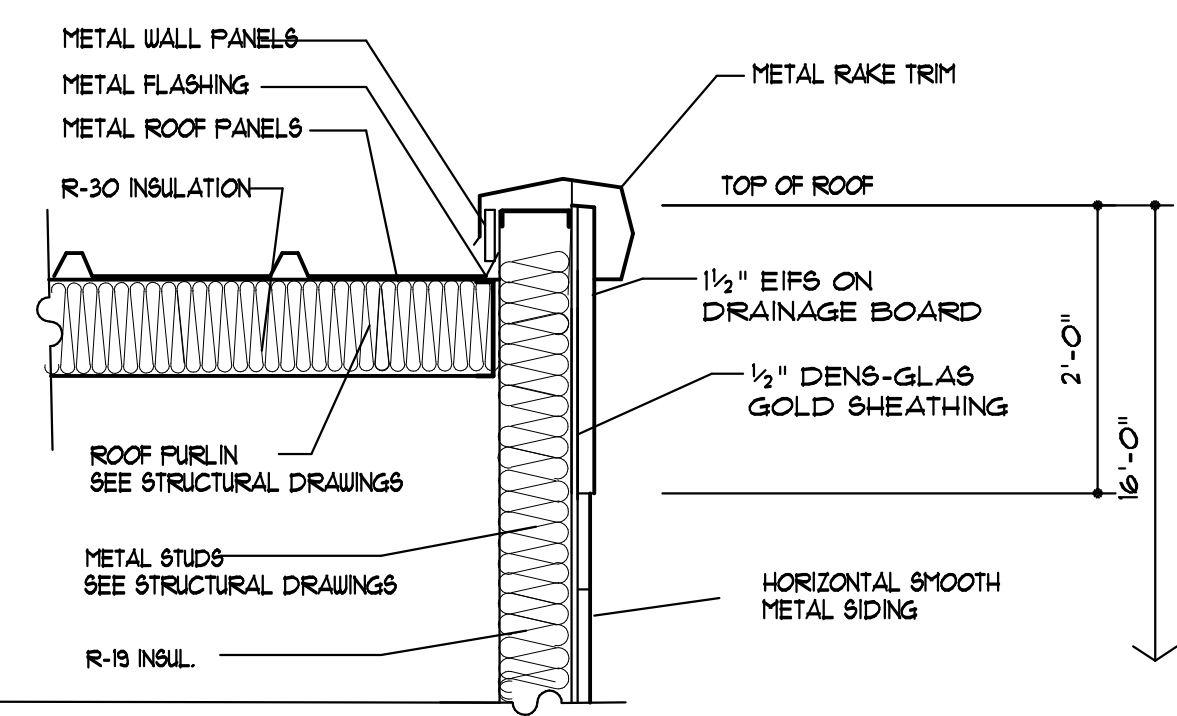

5 TYP. EXTERIOR END WALL  
A-4.1

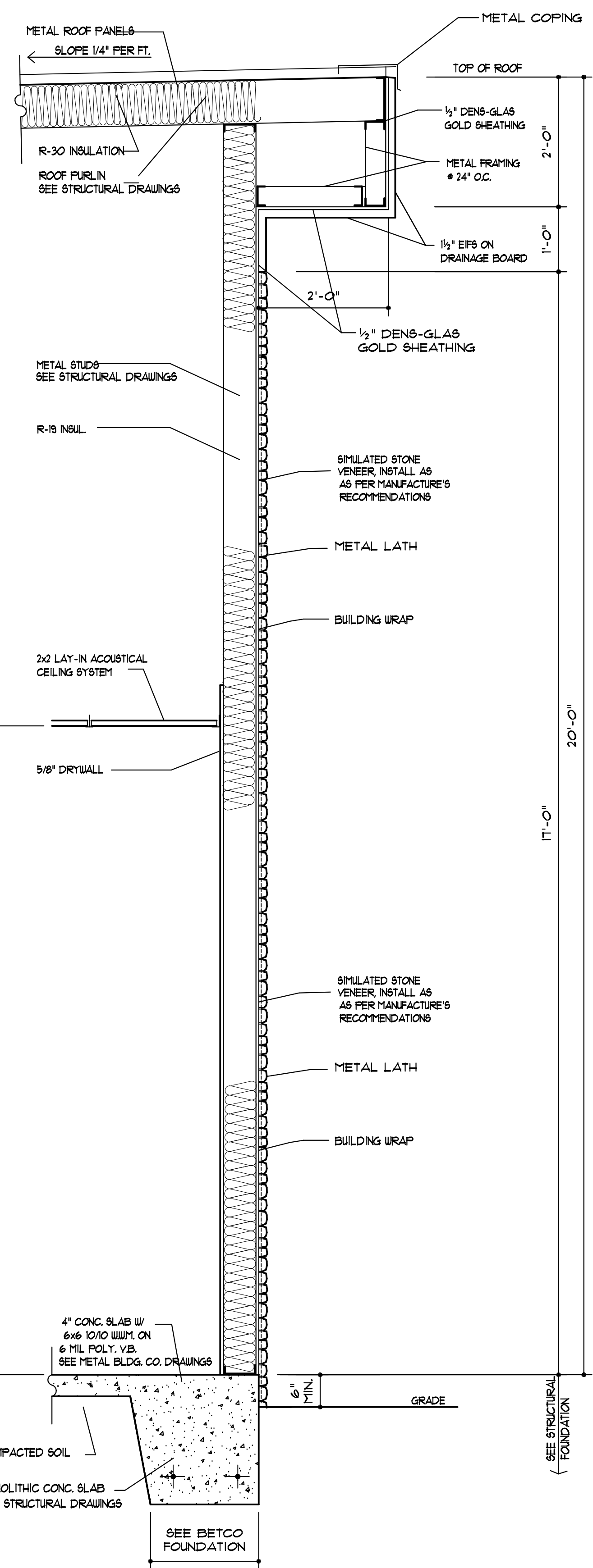

2 TYP. EXTERIOR END WALL  
A-4.1

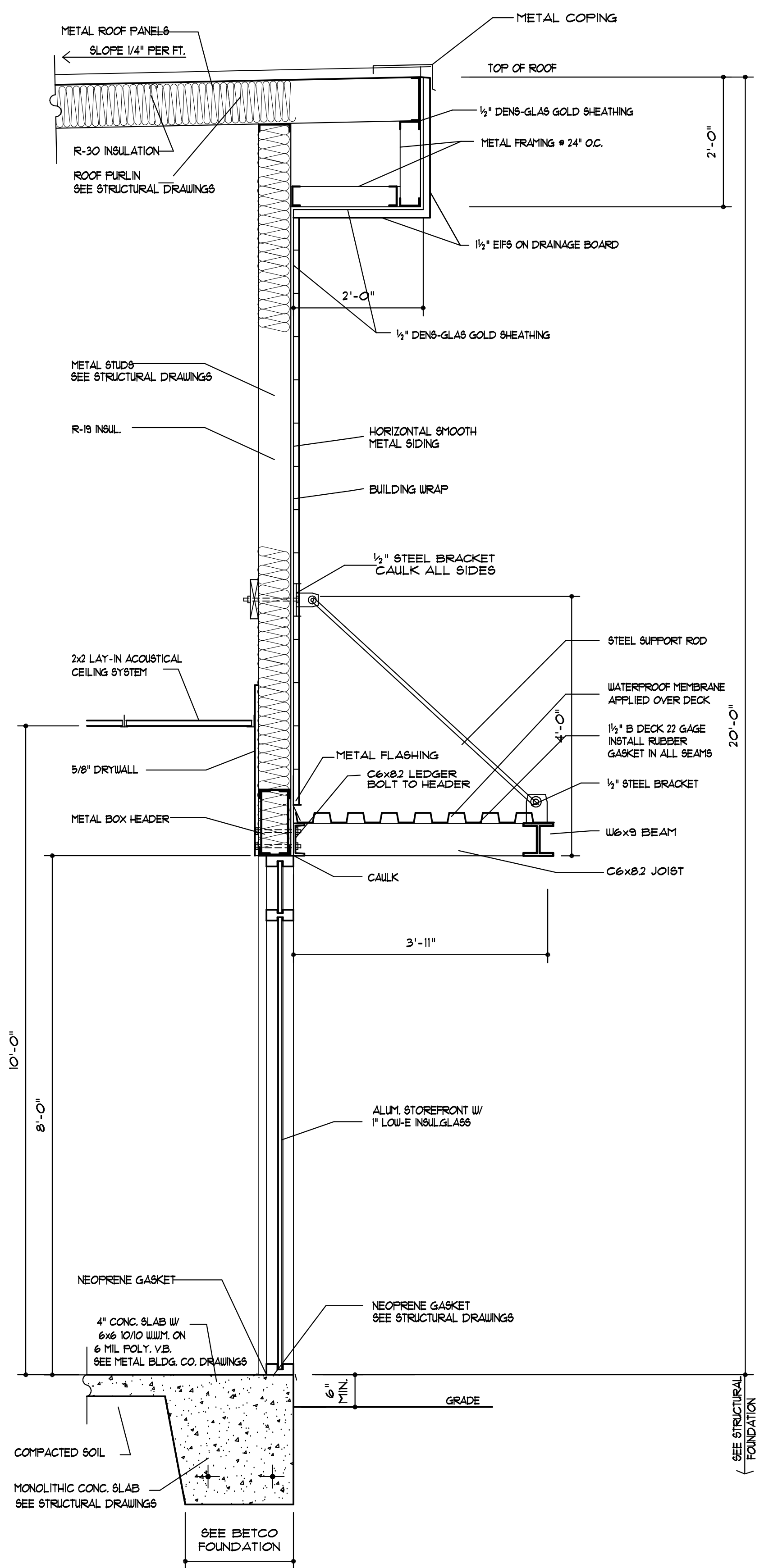

1 TYP. EXTERIOR END WALL  
A-4.1

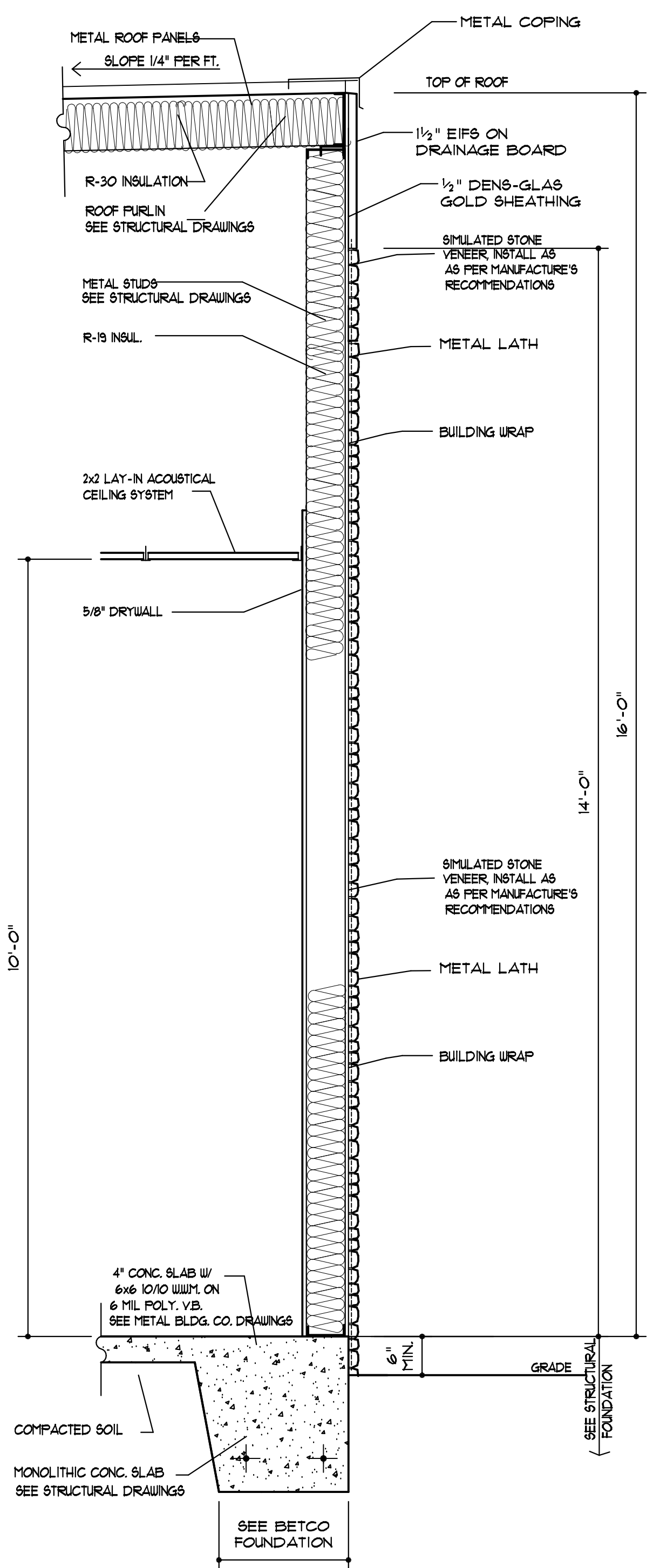

4 TYP. EXTERIOR END WALL  
A-4.1

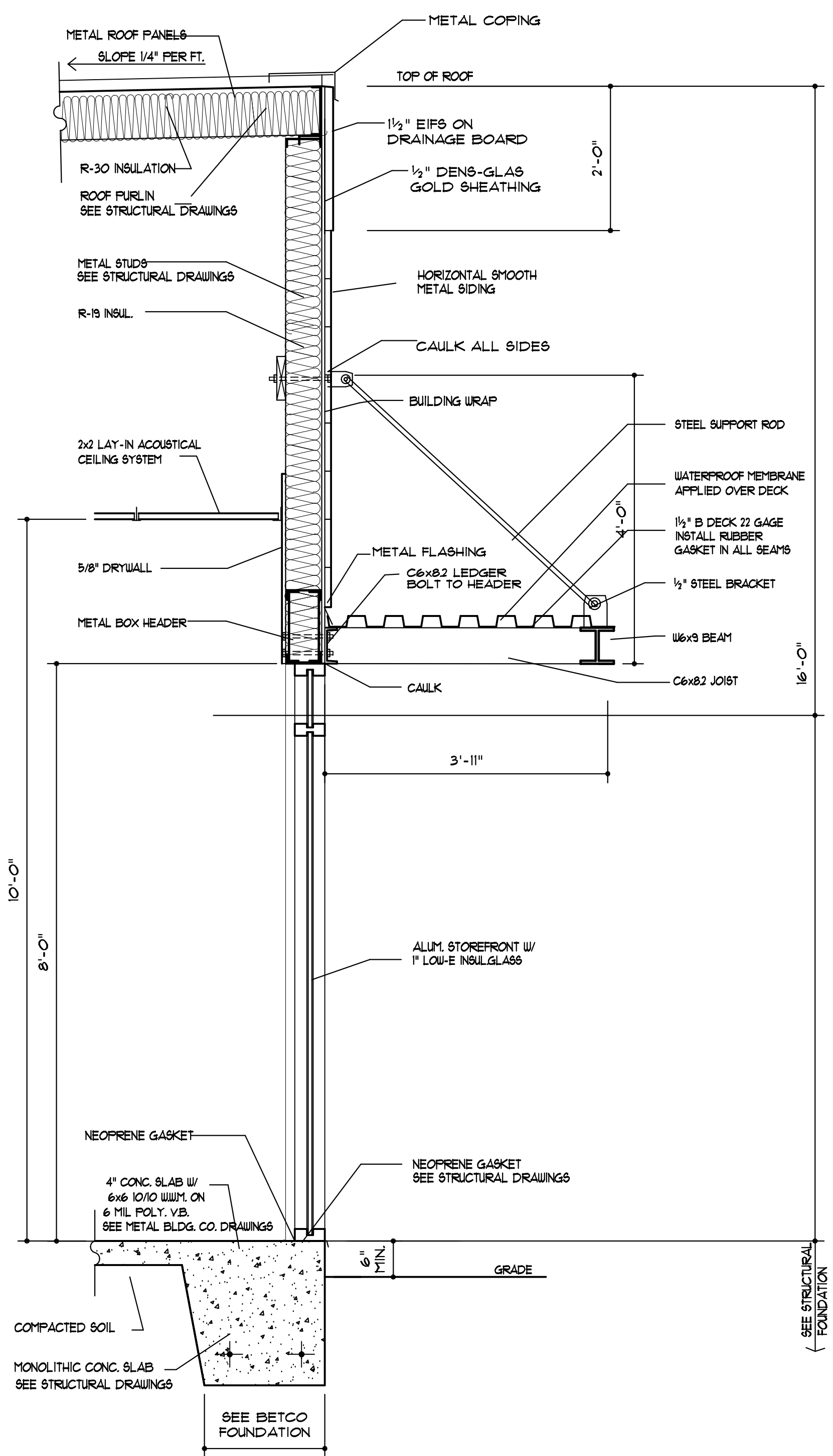

3 TYP. EXTERIOR END WALL  
A-4.1

REVISIONS	BY

DRAWN BY : VJS  
CHECKED BY : VJS  
DATE : 03-08-2022  
SCALE : 3/4" = 1'-0"  
FILE :  
SHEET NUMBER :

**A-4.1**  
BLDG. 'A'

NOTE: DO NOT SCALE DRAWINGS  
PDF & PRINTING CHANGES SCALE

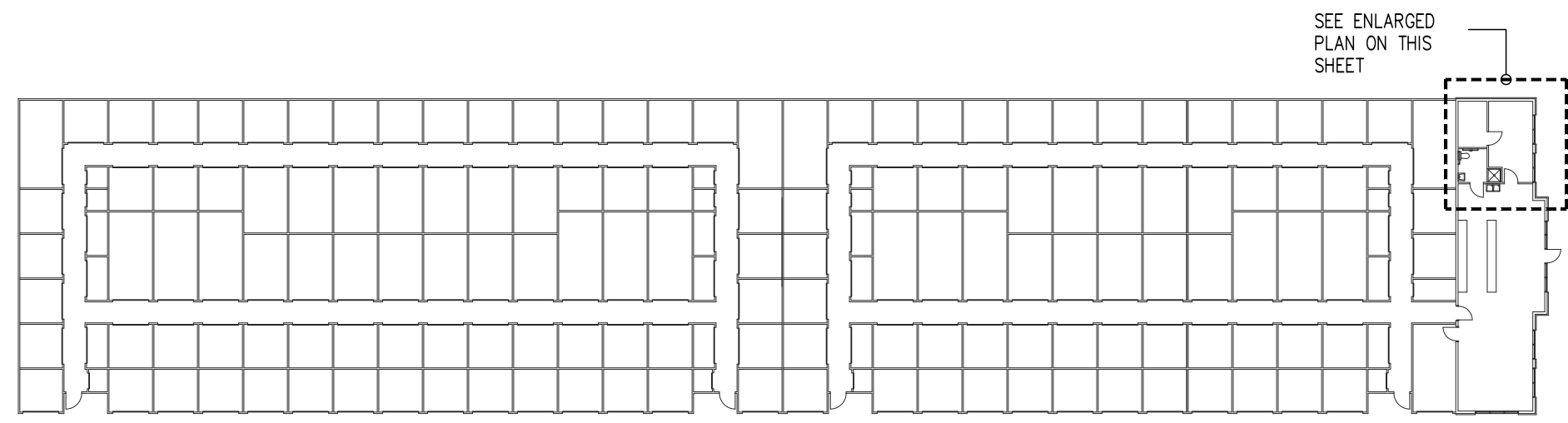

KEY PLAN  
NO SCALE

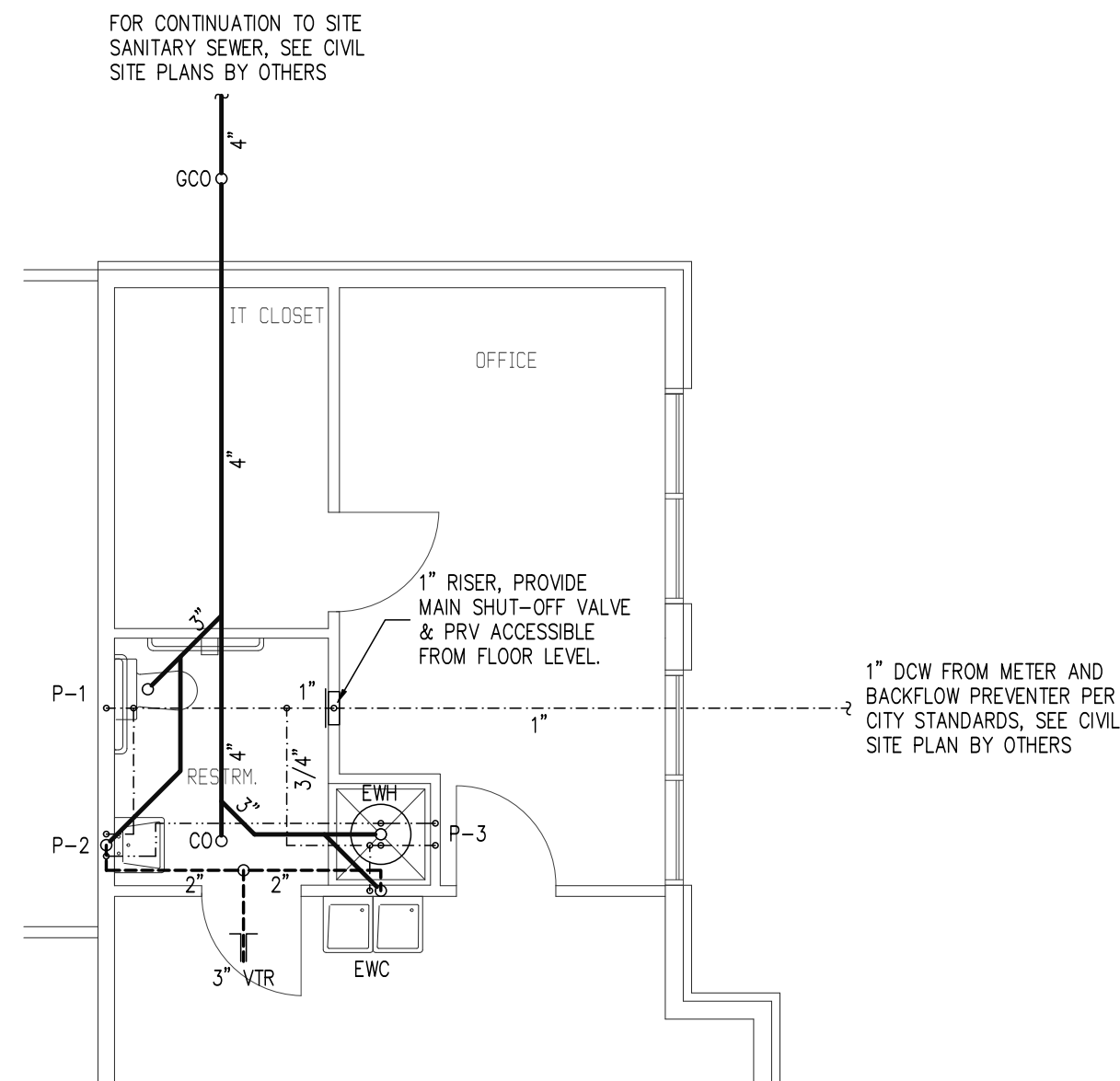

DWV RISER DIAGRAM  
NO SCALE

PIPING SYMBOL LEGEND

	SANITARY SOIL OR WASTE PIPING
	SANITARY BUILDING DRAIN
	ATMOSPHERIC VENT
	CLEAN-OUT
	COLD WATER
	HOT WATER (110°)
	NATURAL GAS
	HOSE BIB
	ANTI FREEZE HYDRANT
	PIPE TURNING UP/DOWN
	SHUTOFF VALVE (BALL TYPE)
	CHECK VALVE
	FIXTURE IDENTIFICATION
	CONNECT TO EXISTING

PLUMBING ABBREVIATION LEGEND

AAV	AIR ADMITTANCE VALVE, STUDOR OR EQUAL
ABV	ABOVE
AFH	ANTI-FREEZE HYDRANT
CLG	CEILING
CW	COLD WATER
CO	CLEAN-OUT
CV	CIRCUIT VENT
EC	ELECTRICAL CONTRACTOR
EWG	ELECTRIC WATER COOLER
FD	FLOOR DRAIN
FS	FLOOR SINK
FW	FILTERED WATER
GCO	GRADE CLEAN OUT (AT FINISH GRADE IN CONC. PAD
GC	GENERAL CONTRACTOR
HB	HOSE BIBB
HW	HOT WATER
HWCP	HOT WATER CIRCULATION PUMP
MC	MECHANICAL CONTRACTOR
P-X	PLUMBING FIXTURE NO. "X", SEE FIXTURE SCHEDULE
RD	ROOF DRAIN
RDL	ROOF DRAIN LEADER
V	VENT
VTR	VENT THROUGH ROOF
W	WASTE
WCO	WALL CLEAN-OUT

PLUMBING FIXTURE SCHEDULE

MARK	DESCRIPTION	MINIMUM CONNECTIONS				REMARKS
		WASTE	VENT	CW	HW	
P-1	ACCESSIBLE (ADA) FLOOR MOUNT, FLUSH TANK WATERCLOSET	3"	2"	1/2"	NA	WHITE VITREOUS CHINA, ELONGATED BOWL, WHITE OPEN FRONT SEAT W/ SELF-SUSTAINING CHECK HINGES, 1.6 GPF SEAT HEIGHT PER N.C. ACCESSIBILITY CODE
P-2	ACCESSIBLE (ADA) WALL-HUNG LAVATORY	2"	2"	1/2"	1/2"	WHITE VITREOUS CHINA, SINGLE LEVER FAUCET, ASSE 1070 MIXING VALVE, C.P. GRID STRAINER & TAILPIECE W/ 1-1/2" P-TRAP W/ C.O., C.P. RIGID SUPPLIES W/ ANGLE STOP, ADA TRAP AND SUPPLY INSULATION KIT
P-3	MOP SINK	3" FD	2"	1/2"	1/2"	PRE-CAST RECEPTOR W/ FLOOR DRAIN ROUGH C.P. MIXING WALL FAUCET W/ VAC. BRKR., BUCKET HOOK, WALL BRACE, HOSE THREAD OUTLET, MOP RACK & WALL GUARDS.
EWG	ACCESSIBLE (ADA) ELECTRIC WATER COOLER	2"	2"	1/2"	NA	DUAL HEIGHT BASINS WITH FLOOR CARRIER CHAIR, 120V 8-GPH, LEAD-FREE, CFC-FREE
EWH	ELECTRIC WATER HEATER	NA	NA	3/4"	3/4"	20 GALLON STORAGE, 1500 WATT, 120V 1PH W/ T&P RELIEF, VACUUM BREAKER, EXPANSION TANK AND CATCH-PAN, BRADFORD-WHITE, STATE, A.O. SMITH OR EQUAL.

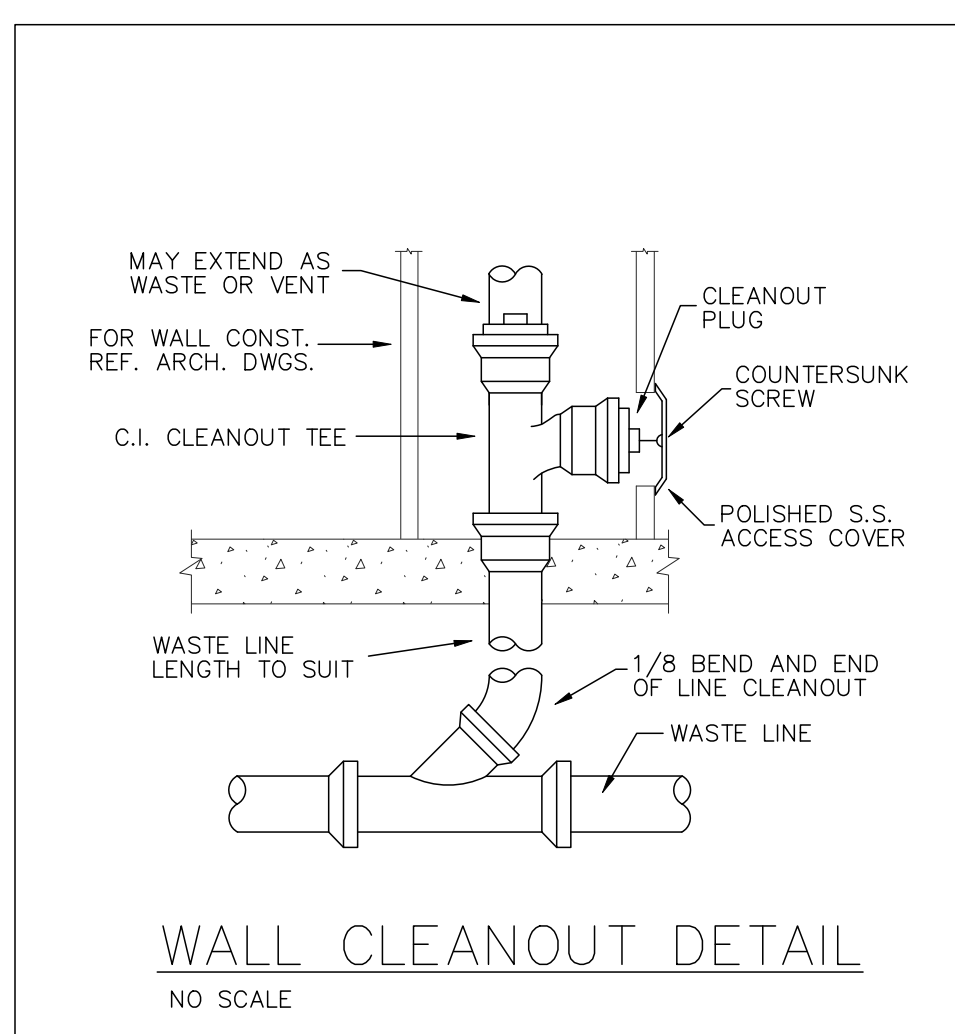
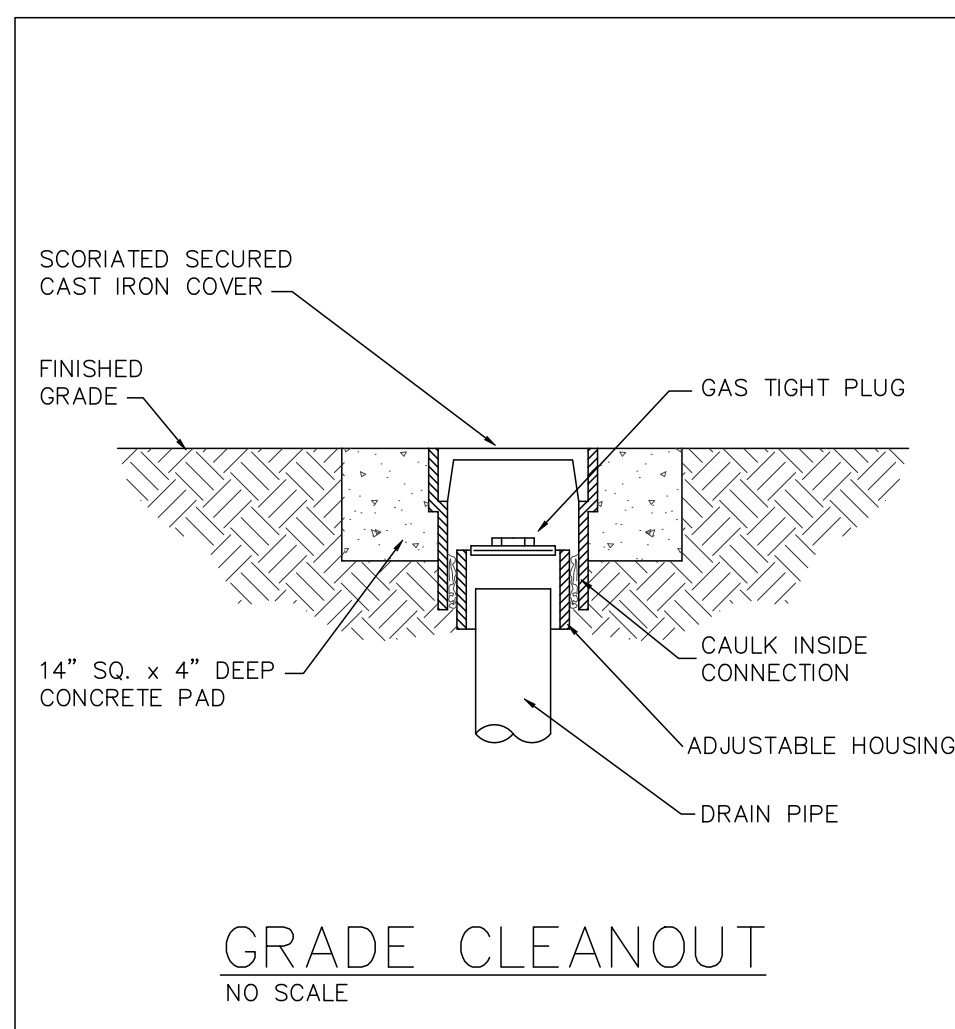
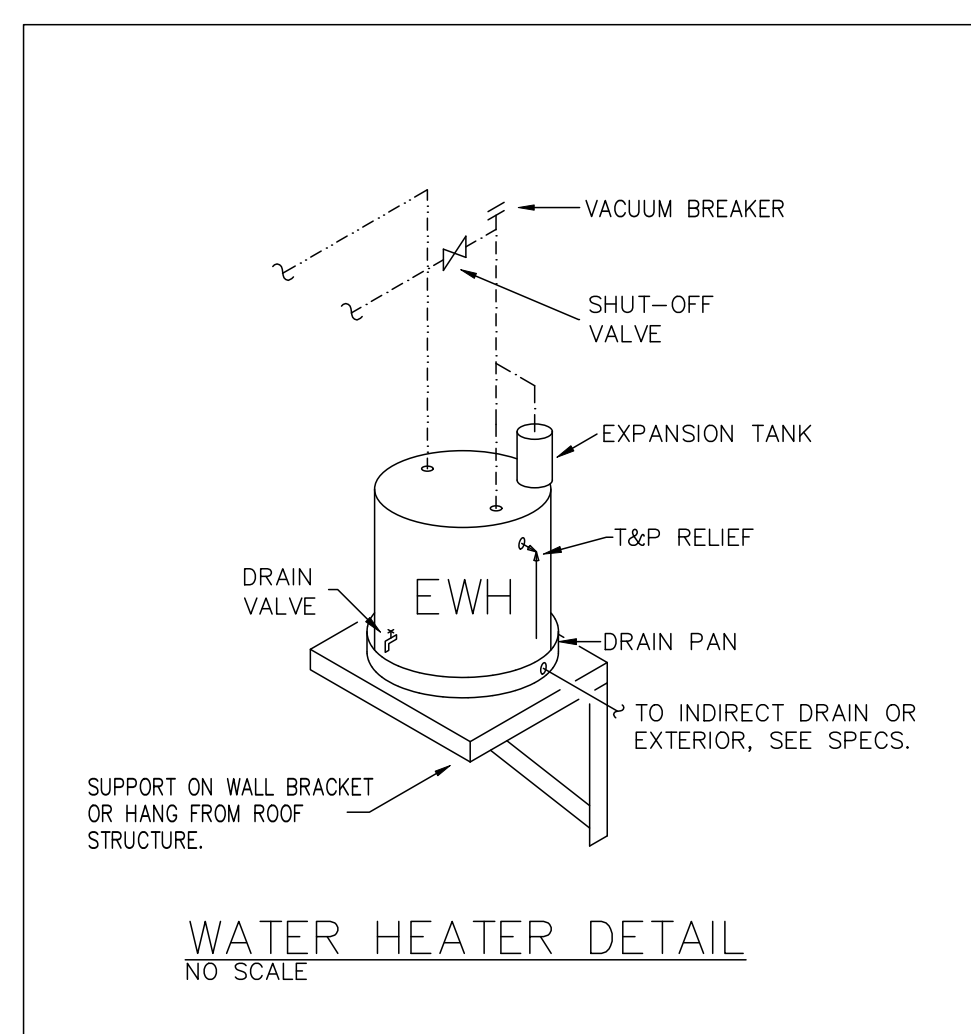
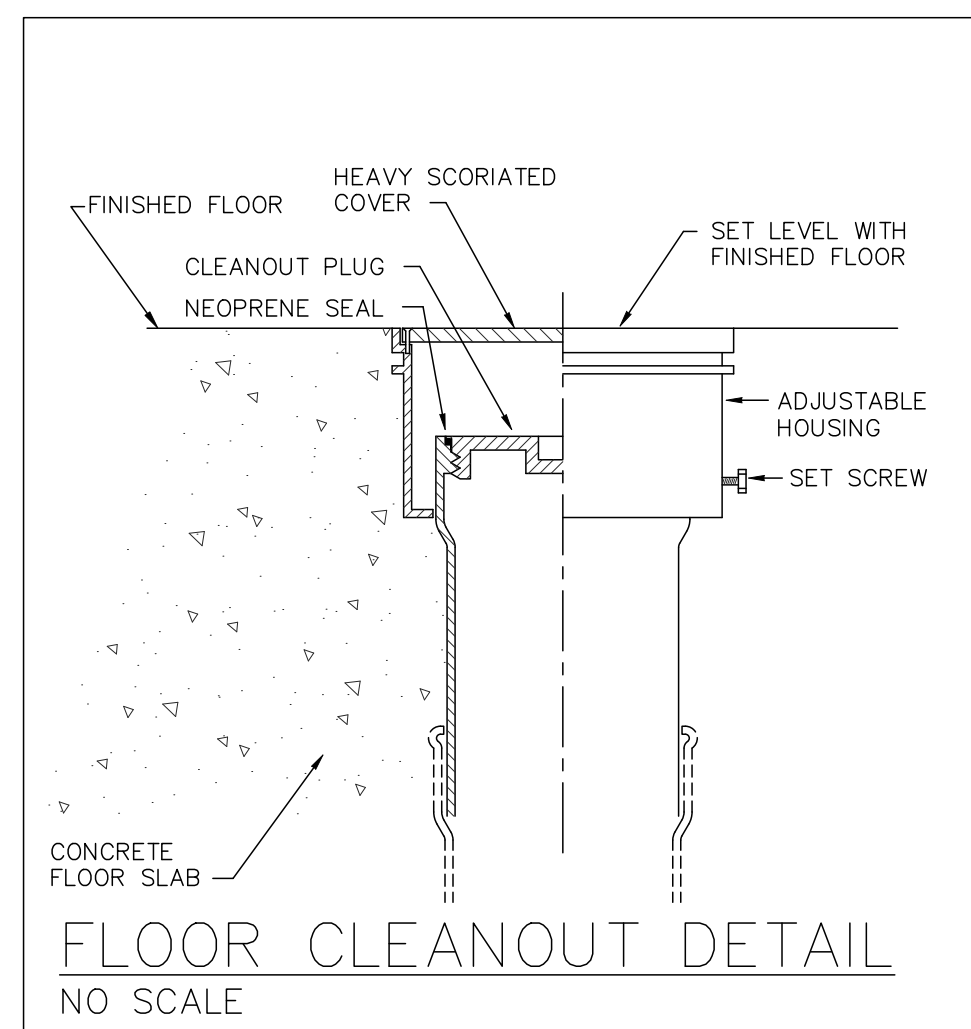

PLUMBING SPECIFICATIONS  
GENERAL

ALL PLUMBING WORK SHALL BE IN STRICT ACCORDANCE WITH THE CURRENTLY ADOPTED EDITION OF THE NORTH CAROLINA PLUMBING CODE THE AND APPLICABLE REFERENCED STANDARDS.

THE WORK INCLUDES PROVIDING MATERIALS, FITTINGS AND ACCESSORIES NECESSARY FOR A COMPLETE FUNCTIONING PLUMBING SYSTEM. ALL MATERIALS FURNISHED BY THE CONTRACTOR SHALL BE NEW AND UNUSED AND FREE FROM DEFECTS. ANY ITEM NOT SPECIFICALLY SHOWN ON THE DRAWINGS OR CALLED FOR IN THE SPECIFICATIONS, BUT THAT IS NORMALLY REQUIRED TO CONFORM TO THE INTENT, ARE TO BE CONSIDERED A PART OF THE CONTRACT. THE WORK MAY ALSO INCLUDE ROUGH-IN AND FINAL CONNECTIONS TO EQUIPMENT PROVIDED BY OTHERS. ALL WORK SHALL BE IN ACCORDANCE WITH LOCAL CODES AND/OR ORDINANCES AND IS SUBJECT TO INSPECTION.

HOOK-UP CHARGES, PERMITS, LOCAL FEES AND ALL OTHER EXPENSES RELATED TO A COMPLETE AND FUNCTIONING PLUMBING SYSTEM SHALL BE INCLUDED IN THE CONTRACTORS BID. THE CONTRACTOR SHALL COOPERATE FULLY WITH LOCAL COMPANIES WITH RESPECT TO THEIR SERVICES.

THE INTENT OF THE DRAWINGS IS TO INDICATE THE GENERAL EXTENT OF WORK REQUIRED FOR THE PROJECT. THE DRAWINGS FOR PLUMBING WORK ARE DIAGRAMMATIC, SHOWING THE GENERAL LOCATIONS & TYPES OF FIXTURES AND EQUIPMENT REQUIRED. THE DRAWINGS SHALL NOT BE SCALED FOR EXACT MEASUREMENTS. REFER TO MANUFACTURER'S STANDARD ROUGH-IN DRAWINGS FOR PLUMBING FIXTURE INSTALLATION REQUIREMENTS. COMPLY WITH ALL APPLICABLE ADA INSTALLATION REQUIREMENTS.

COORDINATION: COORDINATE WITH THE WORK OF OTHER SECTIONS, EQUIPMENT FURNISHED BY OTHERS, REQUIREMENTS OF THE OWNER, AND WITH THE CONSTRAINTS OF THE EXISTING CONDITIONS OF THE PROJECT SITE. ANY WORK THAT IS INSTALLED BY THIS CONTRACTOR THAT RESULTS IN CONFLICT, DUE TO LACK OF COORDINATION BETWEEN TRADES, SHALL BE CHANGED AS DIRECTED BY THE ARCHITECT/ENGINEER WITHOUT ADDITIONAL COMPENSATION TO THE CONTRACTOR.

DEFINITIONS

FURNISH MEANS TO SUPPLY AND DELIVER TO PROJECT SITE, READY FOR INSTALLATION. INSTALL MEANS TO PLACE IN POSITION AND MAKE CONNECTIONS FOR SERVICE OR USE. PROVIDE MEANS TO FURNISH AND INSTALL, COMPLETE AND READY FOR INTENDED USE.

FIRESTOPPING IS A MATERIAL OR COMBINATION OF MATERIALS USED TO RETAIN INTEGRITY OF FIRE-RATED CONSTRUCTION BY MAINTAINING AN EFFECTIVE BARRIER AGAINST THE SPREAD OF FLAME, SMOKE, AND HOT GASES THROUGH PENETRATIONS IN FIRE RATED WALL AND FLOOR ASSEMBLIES.

PROVIDE LABOR AND MATERIALS TO REPAIR OR REPLACE DEFECTIVE PARTS AND MATERIALS AS REQUIRED FOR ONE YEAR AFTER SUBSTANTIAL COMPLETION OR OWNER ACCEPTANCE OF THE COMPLETED PROJECT.

PROVIDE ALL FITTINGS, ACCESSORIES, OFFSETS, AND MATERIALS NECESSARY TO FACILITATE THE PLUMBING SYSTEM'S FUNCTIONING AS INDICATED BY THE DESIGN AND THE EQUIPMENT INDICATED.

PIPING SYSTEMS  
GENERAL:

MATERIALS PENETRATING FIRE RATED CONSTRUCTION SHALL BE PROVIDED AS LISTED IN AN APPROVED U.L. TESTED FIRESTOP SYSTEM.

ALL PIPING SHALL BE RUN PARALLEL TO BUILDING LINES AND SUPPORTED AND ANCHORED AS REQUIRED TO FACILITATE EXPANSION AND CONTRACTION. ALL PIPING SHALL BE CONCEALED EXCEPT IN UNFINISHED SPACES. INSTALL AS REQUIRED TO MEET ALL CONSTRUCTION CONDITIONS AND TO ALLOW FOR INSTALLATION OF OTHER WORK SUCH AS DUCTS AND ELECTRICAL CONDUIT. AT ALL CONNECTIONS BETWEEN FERROUS PIPING AND NONFERROUS PIPING, PROVIDE AN ISOLATING DIELECTRIC UNION. ALL HANGERS SHALL BE COMPATIBLE WITH PIPING MATERIAL TO PREVENT CORROSION.

SEWER AND WASTE PIPING:

PROVIDE ALL DRAINS AND SEWERS WITHIN THE SPACE WITH CONNECTION TO THE EXISTING DRAINAGE SYSTEMS ON-SITE. SANITARY DRAINAGE PIPING ABOVE FLOOR SHALL BE HUBLESS CAST-IRON PIPE, FITTINGS AND CONNECTIONS OR DWV PVC PLASTIC SCHEDULE 40 PIPING WITH SOLVENT WELD FITTINGS. SANITARY DRAINAGE PIPING BELOW GRADE SHALL BE SERVICE-WEIGHT HUB AND SPIGOT TYPE CAST-IRON WITH NEOPRENE GASKET JOINTS OR DWV PVC PLASTIC SCHEDULE 40 PIPING WITH SOLVENT WELD FITTINGS.

FOR PLASTIC SEWER PIPING, AN INSULATED COPPER TRACER WIRE OR OTHER APPROVED CONDUCTOR SHALL BE INSTALLED ADJACENT TO AND OVER THE FULL LENGTH OF THE PIPING. ACCESS SHALL BE PROVIDED TO THE TRACER WIRE OR THE TRACER WIRE SHALL TERMINATE AT THE CLEANOUT BETWEEN THE BUILDING DRAIN AND BUILDING SEWER. THE TRACER WIRE SIZE SHALL BE NOT LESS THAN 14 AWG AND THE INSULATION TYPE SHALL BE LISTED FOR DIRECT BURIAL.

BUILDING SEWER PIPING WITHIN 5 FT OF WATER PIPING BELOW GRADE SHALL BE CAST-IRON PIPE PER ASTM A 74, CSPI 301, AND ASTM A 888 OR SHALL BE SCHEDULE 40 PVC DWV PIPE CONFORMING TO ASTM F 1488.

PIPE FITTINGS SHALL BE APPROVED FOR INSTALLATION WITH THE PIPING MATERIAL INSTALLED AND SHALL CONFORM TO THE RESPECTIVE PIPE STANDARDS REFERENCED IN THE N.C. PLUMBING CODE.

ALL DRAINAGE PIPING SHALL BE UNIFORMLY PITCHED, MINIMUM 1/8" PER FOOT FOR 3" AND LARGER AND 1/4" PER FOOT FOR 2" AND SMALLER UNLESS OTHERWISE REQUIRED BY EXISTING CONDITIONS, OR INDICATED ON THE DRAWINGS.

CLEANOUTS:

PROVIDE CLEANOUTS AT THE END OF EACH HORIZONTAL RUN, AND AT THE BASE OF ALL VERTICAL WASTE AND DRAIN PIPES. CLEANOUTS SHALL BE OF THE SAME SIZE AS THE PIPES THEY SERVE, CONFORMING TO CODE REQUIREMENTS. PROVIDE SUITABLE WALL OR FLOOR CLEANOUTS WITH ACCESSORIES TO OBSCURE FROM VIEW.

VENTS:

PROVIDE A COMPLETE SYSTEM OF STANDARD WEIGHT CAST IRON NO-HUB VENT RISERS WHERE THE CEILING SPACE IS USED AS A RETURN AIR PLENUM OR USE DWV PLASTIC WHERE THERE IS A DUCTED RETURN AIR SYSTEM. DO NOT USE DWV PLASTIC IN RETURN AIR PLENUM SPACES.

THE VENT SYSTEM SHALL BE CARRIED THROUGH THE ROOF WITH APPROPRIATE FLASHING.

WATER DISTRIBUTION PIPING:

LAYOUT WATER PIPING SO THAT THE ENTIRE SYSTEM CAN BE DRAINED. HOT AND COLD WATER PIPING SHALL CONFORM TO NSF 61 AND ONE OF THE CORRESPONDING STANDARDS LISTED IN TABLE 605.3(SERVICE PIPE) & 605.4(DISTRIBUTION PIPE) OF THE 2018 NC PLUMBING CODE. PROVIDE WATER HAMMER ARRESTERS AT EACH FIXTURE OR GROUP OF FIXTURES AS REQUIRED. INSTALL CHROME PLATED BRASS ESCUTCHEON PLATES AT ALL PENETRATIONS THROUGH FINISHED SURFACES (INCLUDING CABINET INTERIORS).

TEST WATER SYSTEM AND PROVE TIGHT UNDER A WATER PRESSURE OF NOT LESS THAN 100 PSI OR FOR PIPING SYSTEMS OTHER THAN PLASTIC, BY AN AIR TEST OF NOT LESS THAN 100 PSI. WATER SHALL BE OBTAINED FROM A POTABLE SOURCE OF SUPPLY. WHEN TESTING INDICATES MATERIALS OR WORKMANSHIP IS DEFICIENT, REPLACE OR REPAIR AS REQUIRED, AND REPEAT TEST UNTIL STANDARDS ARE ACHIEVED.

INSULATE ALL HOT WATER SUPPLY AND RETURN PIPING & CW PIPING OUTSIDE OF BUILDING INSULATION ENVELOPE (EXCEPT AT FIXTURE CONNECTIONS) WITH 1 INCH OF INSULATION HAVING A CONDUCTIVITY NOT EXCEEDING 0.28 BTU PER INCH/H\*F.F. INSULATE COLD WATER PIPING WITH 1/2 INCH OF INSULATION TO PREVENT CONDENSATION. INSULATE ANY EXPOSED CONDENSATE PIPING WITH WASTE TEMPERATURE BELOW 60 DEGREES F.

SHUTOFF VALVES WITH UNIONS SHALL BE PROVIDED FOR SERVICE TO EACH PLUMBING FIXTURE TO FACILITATE ISOLATION FOR REPAIR OR REPLACEMENT. VALVES SHALL BE EQUAL TO JENKINS BALL VALVE, CHROME-FINISHED BRONZE, TEFLON SEATS AND PACKING, 400 LB. W.O.G., SOLDER END.

INSTALLATION

FOLLOW MANUFACTURER'S INSTRUCTIONS FOR INSTALLING, CONNECTING, AND ADJUSTING ALL EQUIPMENT AND PLUMBING SYSTEM COMPONENTS.

THOROUGHLY CLEAN ITEMS BEFORE INSTALLATION. CAP PIPE OPENINGS TO EXCLUDE DIRT UNTIL FIXTURES ARE INSTALLED AND FINAL CONNECTIONS HAVE BEEN MADE. PROCEED AS RAPIDLY AS CONSTRUCTION WILL PERMIT. SET FIXTURES LEVEL AND IN PROPER ALIGNMENT. INSTALL SUPPLIES IN PROPER ALIGNMENT WITH FIXTURES. INSTALL SILICONE SEALANT BETWEEN FIXTURES AND ADJACENT MATERIAL, FOR SANITARY JOINT, AND OMIT ESCUTCHEONS.

ACCESS PANELS SHALL BE PROVIDED WHERE CONCEALED CONTROL DEVICES, VALVES, ETC. ARE CONCEALED WITHIN WALLS. WHERE ACCESS FOR ADJUSTMENT AND MAINTENANCE IS POSSIBLE THROUGH LAY-IN SUSPENDED CEILINGS, ACCESS PANELS ARE NOT REQUIRED.

ROOF PENETRATIONS SHALL COMPLY WITH "SMACNA" AND "NRCA" STANDARDS, AND WITH THE REQUIREMENTS OF THE ROOFING WARRANTY, IF APPLICABLE. DO NOT PERFORM ROOFING PENETRATIONS IN A MANNER WHICH WOULD VOID OR OTHERWISE LIMIT THE ROOFING WARRANTY.

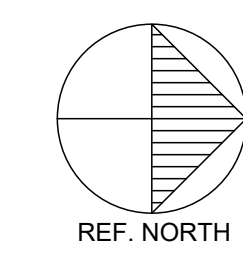

PLUMBING PLAN  
SCALE: 3/16" = 1'-0"

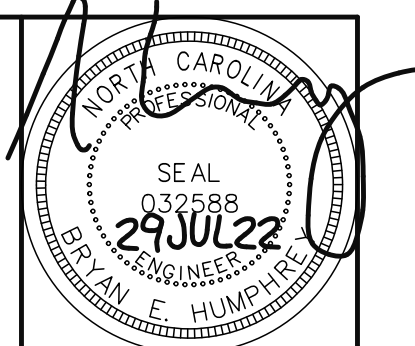

REVISIONS

NO.	DESCRIPTION

**EUBANKS**  
ENGINEERING  
**HUMPHREY**

102 Pateley St., Suite 200  
Greensboro, NC 27401

Phone 336.379.0663  
Fax 336.379.0663

FIRM LICENSE: C-2272

BUILDING SYSTEMS PLANS FOR:

**HARNETT SELF STORAGE**  
SPOUT SPRINGS, NC

JOB NO. 2278  
ORIGINAL ISSUE DATE 29JUL22  
DRAWN BY JMK  
CHECKED BY BEH  
SHEET NO.

**P-1**  
OF 1

### HVAC ABBREVIATIONS

ABV	ABOVE
AD	DUCT ACCESS DOOR
BDD	BACK-DRAFT-DAMPER
CD	CEILING DIFFUSER
CFM	CUBIC FEET/MINUTE
COMP	COMPRESSOR
DMPR	DAMPER
EC	ELECTRICAL CONTRACTOR
ECR	EGGCRATE RETURN GRILLE
ED	EXHAUST DUCT
EF	EXHAUST FAN
EG	EXHAUST GRILLE
ER	EXHAUST REGISTER
EVAP	EVAPORATOR
FRAG	FILTERED RETURN AIR GRILLE
FD	FIRE DAMPER, PER ASSEMBLY RATING
FOB	FLAT ON BOTTOM DUCT TRANSITION
FOT	FLAT ON TOP DUCT TRANSITION
GC	GENERAL CONTRACTOR
GD	GREASE EXHAUST DUCT
KES	KITCHEN EQUIPMENT SUPPLIER
MUAI	MAKE-UP AIR INTAKE
MUAD	MAKE-UP AIR DUCT
MUAF	MAKE-UP AIR FAN
CAI	OUTSIDE-AIR-INTAKE
OAD	OUTSIDE AIR DUCT
PC	PLUMBING CONTRACTOR
PDD	PERFORATED FACE DIRECTIONAL DIFFUSER
RAD	RETURN-AIR DUCT
RAG	RETURN AIR GRILLE
RAR	RETURN AIR REGISTER
RCD	ROUND CEILING DIFFUSER
RDR	ROUND DUCT REGISTER
RH	RADIANT HEATER
RTS	ROUND TO SQUARE DUCT TRANSITION
RTU	ROOFTOP HVAC UNIT
SAD	SUPPLY AIR DUCT
SAF	SUPPLY AIR FAN
SR	SUPPLY REGISTER
SG	SUPPLY GRILLE
STR	SQUARE TO ROUND DUCT TRANSITION
TG	TRANSFER GRILLE, EQUAL TO RAG
TSTAT	THERMOSTAT
UCD	UNDER-CUT DOOR 1"
VAVCD	VARIABLE VOLUME CEILING DIFFUSER

### HVAC PLAN SYMBOLS

	RECTANGULAR & ROUND DUCTWORK ABOVE CEILING, NET INTERNAL SIZE AS INDICATED GALVANIZED STEEL SHEET CONSTRUCTED TO SMACNA LOW PRESSURE STANDARD, INSULATED.
	CEILING DIFFUSER (CD), 24X24 LAY-IN SQUARE CONE DIFFUSER, PROVIDE VOLUME DAMPER AT DUCT TAKEOFF FOR BALANCING, NECK SIZE AS INDICATED.
	RETURN AIR GRILLE (RAG), 24X24 LAY-IN PERFORATED FACE, PROVIDE VOLUME DAMPER AT NECK CONNECTION OR DUCT TAKE-OFF FOR BALANCING, NECK SIZE AS INDICATED.
	RETURN AIR REGISTER (RAR) WITH INTEGRAL DAMPER, SIZE AS INDICATED.
	EXHAUST FAN, CFM AS INDICATED.
	COMBO EXHAUST FAN & LIGHT, CFM AS INDICATED, OF LAMP OPTION.
	VOLUME DAMPER TAKE-OFF, USE TO ROUGH BALANCE AIR SYSTEM, THEN FASTEN DAMPERS SECURELY IN PLACE.
	VOLUME DAMPER W/ 45° TAKE-OFF, USE TO ROUGH BALANCE AIR SYSTEM, THEN FASTEN DAMPERS SECURELY IN PLACE.
	PROGRAMMABLE ELECTRONIC THERMOSTAT +45° AFF TO TOP

NOTE: THIS PROJECT MAY NOT USE EVERY SYMBOL OR DEVICE APPEARING ON THIS LEGEND.

### MITSUBISHI ELECTRIC TRANE HVAC US: CITY MULTI VRF OUTDOOR UNIT SCHEDULE

System Tag	System 1
Tag Reference	HP
M-NET Address	51
Model Number	PUMY-P48NKMU3-BS
Modules	P48
Nominal Cooling Capacity (BTU/h)	48,000.0
Nominal Heating Capacity (BTU/h)	54,000.0
Cooling Efficiency IEER/IEER (SEER)	0 / 12.2 [19.55]
Heating COP @ 47°F [HSPF]	4.08 [11.5]
Nom System Connected Capacity (% of NOM)	100.0%
Design Cooling Outdoor Temp DB (°F)	95.0
Design Heating Outdoor Temp WB (°F)	43.0
Max Pipe Length from BC or 1st Joint (feet)	33.9
Refrig Pipe Dim High/Low Pressure (inch) (See Note 4)	3/8 / 5/8
Corrected Cooling Total Capacity (BTU/h)	46,222.2
Corrected Heating Capacity (BTU/h)	50,748.9
Sound Pressure (dBA)	51/54
Compressor Type	SCROLL
Compressor Quantity	1
Preliminary Added Field Charge (See Note 5)	8.7
Voltage / Phase	208/230V / 1-phase
MCA 208/230 or [480V]	29
Recommended Fuse Size (RFS)	30
MOCP	44
Applicable System Notes - See Notes Below	1, 2, 3, 4, 5, 6, 7, 8, 9

**Notes & Options:**

- Nominal cooling capacities are based on indoor coil EAT of 80/67°F (DB/WB), outdoor of 95°F (DB)
- Nominal heating capacities are based on indoor coil EAT of 70°F (DB), outdoor of 43°F (WB)
- Efficiency values for IEER, IEER, COP are based on AHRI 1230 test method for mixture of ducted & non-ducted indoor units.
- For systems with multiple modules, refrigerant pipe dimensions indicate total system combined piping downstream of module twinning.
- Added field charge listed is in addition to factory charge, this must be updated based upon final as-built piping layout.
- Factory representatives shall review the project prior to and throughout the installation of CITY MULTI equipment.
- Factory representatives shall startup and commission CITY MULTI equipment upon completion of equipment installations.
- Factory representatives shall provide on-site assistance for the BMS integration of the CITY MULTI equipment.
- Factory representatives shall provide end-user training on the CITY MULTI equipment upon completion of the installation of equipment.

### MITSUBISHI ELECTRIC TRANE HVAC US: CITY MULTI VRF INDOOR UNIT SCHEDULE

System Tag	System 1	System 1
Tag Reference	AHU	AHU
Room Name		
M-NET Address	1	2
Model	PCFY-P24NKMUJ-ER1	PCFY-P24NKMUJ-ER1
Type	Ceiling-Suspended	Ceiling-Suspended
Nominal Cooling Capacity (BTU/h)	24,000.0	24,000.0
Nominal Heating Capacity (BTU/h)	27,000.0	27,000.0
Cooling Design Entering Temp DB/WB (°F) / [Water in temp]	80.0/67.0	80.0/67.0
Heating Design Entering Temp DB/WB (°F) / [Water in temp]	70.0	70.0
Cooling Diversity Full/Partial (See Note 5, 6)	FULL DEMAND	FULL DEMAND
Heating Diversity Full/Partial (See Note 5, 6)	FULL DEMAND	FULL DEMAND
Refrig Pipe Dim Liquid/Suction (inch)	3/8 / 5/8	3/8 / 5/8
Cooling Total Capacity (BTU/h)	23,111.1	23,111.1
Cooling Sensible Capacity (BTU/h)	15,277.8	15,277.8
Heating Capacity (BTU/h)	25,374.5	25,374.5
Estimated Cooling Coil LAT (°F) / [LWT]	57.3	57.3
Estimated Heating Coil LAT (°F) / [LWT]	107.0	107.0
Fan Speed Setting	HIGH	HIGH
Peak Fan Airflow (cfm) / [Design gpm]	636	636
Max Fan ESP Setting 208V/230V (IN WG)		
Sound Pressure Per Fan Speed 208V/230V (dBA)	31-33-35-37	31-33-35-37
Voltage / Phase	208/230V/1-phase	208/230V/1-phase
Power Cooling 208V/230V (kW)	0.04	0.04
Power Heating 208V/230V (kW)	0.04	0.04
Electrical MCA/MFS	0.52/0.52/15	0.52/0.52/15
Condensate Removal Rate (gal/hr)	1.01	1.01
Applicable System Notes - See Notes Below	1, 2, 3, 4, 5, 6	1, 2, 3, 4, 5, 6

**Notes & Options:**

- Nominal cooling capacities are based on indoor coil EAT of 80/67°F (DB/WB), outdoor of 95°F (DB)
- Nominal heating capacities are based on indoor coil EAT of 70°F (DB), outdoor of 43°F (WB)
- See outdoor unit schedule for outdoor ambient conditions, connected capacity, and other factors associated with corrected capacities
- See schematic piping/control diagram for indication of required indoor unit remote controllers, system controllers, and integration devices.
- Full demand corrected capacity includes de-rate associated with indoor vs. outdoor connected capacity indicated on outdoor unit schedule for associated system. Partial corrected capacity assumes sufficient diversity exists such that the connected capacity de-rate does not apply. It is the designer's responsibility to ensure "Diamond System Builder" is set in the appropriate output capacity setting (full demand/partial demand) prior to generating this schedule.
- It is recommended to always base heating corrected capacity on full demand.

NOTE: VRF MANUFACTURER SHALL PROVIDE UPDATED SCHEDULES & PIPING DIAGRAMS BASED ON ACTUAL LAYOUT OF EQUIPMENT.

### MECHANICAL SPECIFICATIONS

THE WORK INCLUDES PROVIDING MATERIALS, FITTINGS AND ACCESSORIES NECESSARY FOR A COMPLETE FUNCTIONING HVAC SYSTEM. ALL MATERIALS FURNISHED BY THE CONTRACTOR SHALL BE NEW AND UNUSED AND FREE FROM DEFECTS. ANY ITEM NOT SPECIFICALLY SHOWN ON THE DRAWINGS OR CALLED FOR IN THE SPECIFICATIONS, BUT THAT IS NORMALLY REQUIRED TO CONFORM TO THE INTENT, ARE TO BE CONSIDERED A PART OF THE CONTRACT. THE WORK MAY ALSO INCLUDE ROUGH-IN AND FINAL CONNECTIONS TO EQUIPMENT PROVIDED BY OTHERS. ALL WORK SHALL BE IN ACCORDANCE WITH LOCAL CODES AND/OR ORDINANCES AND IS SUBJECT TO INSPECTION.

PROVIDE EQUIPMENT INDICATED ON THE DRAWINGS, AND AS REQUIRED FOR A COMPLETE FUNCTIONING SYSTEM. INSTALL ALL HVAC EQUIPMENT AND MATERIALS IN ACCORDANCE WITH MANUFACTURER'S RECOMMENDATIONS.

ALL HVAC WORK SHALL CONFORM TO THE REQUIREMENTS OF THE LATEST ADOPTED EDITIONS OF THE SOUTH CAROLINA BUILDING CODES. INCLUDE PERMITS AND INSPECTION FEES IN CONTRACT.

THE INTENT OF THE DRAWINGS IS TO INDICATE THE GENERAL EXTENT OF WORK REQUIRED FOR THE PROJECT. THE DRAWINGS FOR MECHANICAL WORK ARE DIAGRAMMATIC, SHOWING THE LOCATION, TYPE, DEVICES AND EQUIPMENT REQUIRED. THE DRAWINGS SHALL NOT BE SCALED FOR EXACT MEASUREMENTS. PROVIDE ALL EQUIPMENT, DEVICES, ACCESSORIES, DUCTWORK, OFFSETS, TRANSITIONS, MATERIALS, ETC. NECESSARY TO FACILITATE THE SYSTEM'S FUNCTIONING AS INDICATED BY THE DESIGN AND THE EQUIPMENT FURNISHED BY OTHERS.

DEFINITIONS: FURNISH MEANS TO SUPPLY AND DELIVER TO PROJECT SITE, READY FOR INSTALLATION. INSTALL MEANS TO PLACE IN POSITION AND MAKE CONNECTIONS FOR SERVICE OR USE. PROVIDE MEANS TO FURNISH AND INSTALL, COMPLETE AND READY FOR INTENDED USE.

FIRESTOPPING IS A MATERIAL OR COMBINATION OF MATERIALS USED TO RETAIN INTEGRITY OF FIRE-RATED CONSTRUCTION BY MAINTAINING AN EFFECTIVE BARRIER AGAINST THE SPREAD OF FLAME, SMOKE, AND HOT GASES THROUGH PENETRATIONS IN FIRE RATED WALL, FLOOR/CEILING AND ROOF/CEILING ASSEMBLIES.

WARRANTY: PROVIDE LABOR AND MATERIALS TO REPAIR OR REPLACE DEFECTIVE PARTS AND MATERIALS AS REQUIRED FOR ONE YEAR AFTER SUBSTANTIAL COMPLETION OR OWNER ACCEPTANCE OF THE COMPLETED PROJECT.

PROVIDE OPERATION MANUALS, MAINTENANCE MANUALS AND SCHEMATICS FOR ALL MECHANICAL EQUIPMENT INSTALLED.

COORDINATION: COORDINATE WITH THE WORK OF OTHER SECTIONS, EQUIPMENT FURNISHED BY OTHERS, REQUIREMENTS OF THE OWNER, AND WITH THE CONSTRAINTS OF THE EXISTING CONDITIONS OF THE PROJECT SITE.

CONDENSATE DISPOSAL SHALL BE PROVIDED ACCORDING TO MANUFACTURER'S INSTALLATION INSTRUCTIONS. CONDENSATE SHALL NOT DISCHARGE INTO AN AREA SO AS TO CAUSE A NUISANCE. AN AUXILIARY DRAIN PAN WITH A SEPARATE SECONDARY DRAIN SHALL BE PROVIDED WHERE DAMAGE TO ANY BUILDING COMPONENTS WILL OCCUR AS A RESULT OF OVERFLOW OF THE EQUIPMENT DRAIN PAN OR STOPPAGE IN THE CONDENSATE DRAIN PIPING. THE SECONDARY DRAIN SHALL DISCHARGE TO A CONSPICUOUS POINT OF DISPOSAL TO ALERT OCCUPANTS IN THE EVENT OF A STOPPAGE OF THE PRIMARY DRAIN. CONDENSATE DRAINS SHALL BE TRAPPED ACCORDING TO MANUFACTURER.

COORDINATE ALL REQUIRED ROOF AND WALL OPENINGS WITH THE GENERAL CONTRACTOR. PROVIDE ALL CURBS, FLASHING, SLEEVES, SUPPORTING FRAMES, REINFORCING ANGLES, ETC. WHICH ARE REQUIRED UNLESS DIRECTED OTHERWISE.

DUCT DIMENSIONS: UNLESS OTHERWISE NOTED, DUCT DIMENSIONS ON THE DRAWINGS ARE INSIDE CLEAR DIMENSIONS.

SHEETMETAL DUCTWORK: PROVIDE SHEETMETAL DUCTWORK FABRICATED AND INSTALLED IN ACCORDANCE WITH ASHRAE AND SMACNA STANDARDS. DUCTWORK SHALL BE ASTM A653 GALVANIZED STEEL SHEET, LOCK-FORMING QUALITY, HAVING G90 ZINC COATING IN CONFORMANCE WITH ASTM A90. ALL ANGLE IRON USED FOR SUPPORT SHALL BE GALVANIZED. CONNECTIONS TO WALLS OR FLOOR SHALL BE AIR TIGHT WITH ANGLE IRON AND CALKING. SEAL ALL DUCT SEAMS, TRANSVERSE AND LONGITUDINAL, AIR TIGHT. PROVIDE TURNING VANES AT ALL 90° ELBOWS.

ROUND SHEET METAL DUCT: PROVIDE UL 181, CLASS 1, ROUND SPIRAL LOCKSEAM DUCT CONSTRUCTED OF GALVANIZED STEEL COMPLYING WITH SMACNA STANDARDS.

FLEXIBLE AIR DUCT: PROVIDE FACTORY ASSEMBLED CLASS 0 OR CLASS 1 AIR DUCT TESTED IN ACCORDANCE WITH UL 181 WITH INSULATION AND REINFORCED OUTER PROTECTIVE COVER/VAPOR BARRIER. FLEXIBLE DUCT SHALL MEET NFPA 90A WITH FLAME SPREAD UNDER 25, SMOKE DEVELOPED UNDER 50, AND SHALL BE RATED FOR MINIMUM 2" W.G. PRESSURE AND 0 TO 250°F TEMPERATURE. FLEXIBLE DUCTS SHALL BE INSTALLED SO THAT NO BEND HAS A MEAN RADIUS OF LESS THAN ONE AND HALF TIME THE DUCT DIAMETER. ALL FLEXIBLE DUCTWORK SHALL BE CUT TO THE LENGTHS NECESSARY FOR EACH APPLICATION, AND NO JOINING OF PIECES OF FLEXIBLE DUCTWORK WILL BE PERMITTED. JOINTS BETWEEN FLEXIBLE AND SHEET METAL DUCTS SHALL BE MADE WITH APPROVED METAL BAND CLAMPS.

EXPOSED DUCTWORK: EXPOSED DUCTWORK SHALL BE CLEANED OF DEBRIS AND OIL, THEN WIPED DOWN WITH VINEGAR OR OTHER SURFACE PREPARING CHEMICAL TO PREPARE DUCT FOR PAINT.

DUCT INSULATION: PROVIDE BLANKET TYPE FIBERGLASS INSULATION COMPLYING WITH ASTM C 1290 & NFPA 90A & 90B & WITH FACTORY APPLIED KRAFT PAPER BONDED TO ALUMINUM FOIL, REINFORCED WITH FIBERGLASS VAPOR BARRIER/JACKET. JACKET SHALL CONFORM TO ASTM C-1136, TYPE II. CLOSED-CELL NEOPRENE INSULATION SIMILAR TO ARMAFLEX MAY BE USED IN LIEU OF BLANKET TYPE INSULATION.

ALL SUPPLY AND RETURN AIR DUCTS AND PLENUMS SHALL BE INSULATED WITH A MINIMUM OF R-6 INSULATION WHEN LOCATED IN UNCONDITIONED SPACES INSIDE THE BUILDING AND R-8 MINIMUM WHEN LOCATED OUTSIDE THE BUILDING INSULATION ENVELOPE OR IN ATTIC. WHEN LOCATED WITHIN THE BUILDING ENVELOPE ASSEMBLY, THE DUCT OR PLENUM SHALL BE SEPARATED FROM THE BUILDING EXTERIOR OR UNCONDITIONED SPACE BY A MINIMUM OF R-8. "R" VALUES SHALL BE AS INSTALLED.

DUCT LINER: (WHERE INDICATED) PROVIDE MINIMUM 1" THICK, 1.5 PCF DENSITY, NEOPRENE COATED, LONG TEXTILE FIBER TYPE DUCT LINER CONFORMING TO ASTM C 1071, WITH COATING ON THE AIR STREAM SIDE CONFORMING TO NFPA 90A & 90B. DUCT LINER ADHESIVE SHALL BE AS RECOMMENDED BY DUCT LINER MANUFACTURER, AND SHALL COMPLY WITH ASTM C-916. DUCT LINER FASTENERS SHALL COMPLY WITH SMACNA "HVAC DUCT CONSTRUCTION STANDARDS", LATEST EDITION.

DUCT SEALANT: SEAL DUCT JOINTS, SEAMS AND CONNECTIONS IN ACCORDANCE WITH SC MECHANICAL AND ENERGY CODES. ARRANGE FOR INSPECTIONS IN ACCORDANCE WITH LOCAL AHJ.

DUCT & EQUIPMENT HANGERS: PROVIDE HANGERS AND SUPPORTS TO SECURE EQUIPMENT OR DUCTWORK IN PLACE, PREVENT VIBRATION, & PROVIDE FOR EXPANSION AND CONTRACTION. PROVIDE INSULATION PROTECTION SADDLES TO ACCOMMODATE INSULATION. INSTALL SUPPORTS OF STRENGTH AND RIGIDITY TO SUIT LOADING WITHOUT UNDULY STRESSING BUILDING. SELECT HANGERS AND SUPPORTS CONSTRUCTED FOR THE SPECIFIC APPLICATION AND IN ACCORDANCE WITH THE MANUFACTURER'S RECOMMENDED MAXIMUM LOADING. FASTEN HANGERS AND SUPPORTS TO BUILDING STRUCTURE.

DUCT TURNING VANES: (TO BE PROVIDED WHERE RADIUS ELBOWS WILL NOT FIT SPACE CONSTRAINTS) PROVIDE FABRICATED TURNING VANES AND VANE RUNNERS, CONSTRUCTED IN ACCORDANCE WITH SMACNA "HVAC DUCT CONSTRUCTION STANDARDS". PROVIDE TURNING VANES CONSTRUCTED OF CURVED BLADES, SUPPORTED WITH BARS PERPENDICULAR TO BLADES, AND SET INTO SIDE STRIPS SUITABLE FOR ADJUSTING IN DUCTWORK. FOLLOW SMACNA GUIDELINES FOR SPACING SUPPORT, AND CONSTRUCTION. ALL BLADES SHALL BE SINGLE WIDTH TYPE.

TESTING AND BALANCING: TEST AND ADJUST ALL MECHANICAL SYSTEMS AND OPERATION. ELIMINATE NOISE AND VIBRATION, AND ASSURE PROPER FUNCTION OF CONTROLS. BALANCE ALL SYSTEMS TO WITHIN 5% OF AIR FLOWS INDICATED ON THE DRAWINGS. MARK FINAL BALANCE POSITIONS ON DAMPERS WITH PERMANENT MARKER.

TEMPERATURE CONTROLS: PROVIDE SEVEN DAY PROGRAMMABLE THERMOSTAT COMPATIBLE TO HVAC UNIT(S) AND CONTROL WIRING. THERMOSTAT SHALL HAVE AN ACCESSIBLE MANUAL OVERRIDE THAT WILL RETURN TO THE PRESETBACK OR SHUTDOWN SCHEDULE WITHOUT REPROGRAMMING. THERMOSTAT SHALL MEET SETPOINT ADJUSTMENT FOR UNOCCUPIED MODE. HEATING DOWN TO 55 DEGREES AND COOLING UP TO 85 DEGREES. THERMOSTAT SHALL HAVE AN AUTOMATIC CHANGEOVER FEATURE BETWEEN HEATING & COOLING AND SHALL HAVE A SEPARATE FAN CONTROL. AUTOMATIC CHANGEOVER FUNCTION SHALL INCORPORATE A 5°F DEADBAND.

PROGRAMMING: THE CONTRACTOR SHALL PROGRAM ALL THERMOSTATS AT PROJECT COMPLETION. COORDINATE WITH TENANT FOR PROGRAM SETTINGS.

\*PROVIDE ALL CONTROL WIRING, THERMOSTATS, TRANSFORMERS, ETC. TO MEET SEQUENCE OF OPERATION

# HVAC SYMBOLS, SCHEDULES & NOTES

NO SCALE

### SPLIT HEAT PUMP AIR HANDLER SCHEDULE

BASED ON TRANE SERIES AIR HANDLERS. EQUIVALENT SYSTEMS BY OTHER MANUFACTURERS MAY BE SUBMITTED FOR REVIEW AND ACCEPTANCE BY ENGINEER. PLANS BASED ON THESE SYSTEMS, CHANGES TO WORK OF OTHERS CAUSED BY SUBSTITUTIONS ARE IN THE CONTRACT, M.C. COORDINATE WITH G.C..

SYSTEM MARK	MODEL NO.	CFM	ESP HIGH SPEED (HORIZ.)	POWER	FAN FLA 230/1	AUXILIARY HTG. COIL KW/STEPS/PH (KW@208V)	MINIMUM CKT. AMPS	MAX. CKT. BRKR	BALANCE OUTDOOR AIRFLOW TO ... (CFM)
AHU-1	TEM6A0C48H41SA	1600	0.50"	208V/3PH	6.8	10.8/1/3	45	45	90

### SPLIT HEAT PUMP OUTDOOR UNIT SCHEDULE

BASED ON TRANE SERIES HEAT PUMPS. EQUIVALENT SYSTEMS BY OTHER MANUFACTURERS MAY BE SUBMITTED FOR REVIEW AND ACCEPTANCE BY ENGINEER. PLANS BASED ON THESE SYSTEMS, CHANGES TO WORK OF OTHERS CAUSED BY SUBSTITUTIONS ARE IN THE CONTRACT, M.C. COORDINATE WITH G.C.

SYSTEM MARK	MODEL NO.	NET CLG CAPACITY, MBH	SENSIBLE NET CLG CAPACITY, MBH	REV. CYC. HTG. CAP. (HIGH TEMP) MBH	ARI RATED EFFICIENCY	POWER	COMP. RLA	COND. FLA	MCA	MAX CKT. BRKR
AHU-1	4TWA7048A3	47.7	35.7	46.5	17.5 SEER, 9.0 HSPF	208V/3PH	14.0	0.93	18	30

### DEHUMIDIFIER SCHEDULE

TAG	MAKE	MODEL	CAPACITY	AIRFLOW @ 0.2" W.C.	VOLTAGE	FLA	MOP
DH	APRILAIRE	E100	100 PPD	267 CFM	120V	8.3A	15A

PROVIDE WALL MOUNT DEHUMIDIFIER CONTROL. MODEL 76. PROVIDE DRAIN PAN, CONDENSATE PUMP & WATER LEVEL SENSOR TO SHUT DOWN UNIT. DISCHARGE CONDENSATE TO DRY WELL.

### VENTILATION FOR ACCEPTABLE INDOOR AIR QUALITY

BASED ON 2018 SC MECHANICAL CODE

#### STORAGE AREA

BUILDING'S PRIMARY USE IS STORAGE AND IS INTENDED TO BE OCCUPIED ONLY OCCASIONALLY AND FOR SHORT PERIODS OF TIME. REFERENCE CHAPTER 2 "OCCUPIABLE SPACE" DEFINITION.

BUILDING AREA DOES NOT MEET DEFINITION OF "OCCUPIABLE SPACE". MECHANICAL VENTILATION IS NOT REQUIRED FOR THIS BUILDING.

SALES OFFICE AREA AHU-1

1078 SF X 5 PPL/1000 SF = 5 PPL X 5 CFM/PPL + 1078 SF X .06 CFM/SF = 89 CFM

### 2018 APPENDIX B BUILDING CODE SUMMARY FOR ALL COMMERCIAL PROJECTS MECHANICAL design

#### MECHANICAL SYSTEMS, SERVICE SYSTEMS AND EQUIPMENT

**Thermal Zone**  
winter dry bulb: 18° F  
summer dry bulb: 91.5° F

**Interior design conditions**  
winter dry bulb: 68° F  
summer dry bulb: 75° F  
relative humidity: 50%

**Building heating load:** 214.2 MBH

**Building cooling load:** 19.9 TONS

#### Mechanical Spacing Conditioning System

Utility  
description of unit: SEE SCHEDULE(S)  
heating efficiency: SEE SCHEDULE(S)  
cooling efficiency: SEE SCHEDULE(S)  
size category of unit: SEE SCHEDULE(S)

#### Boiler

Size category, if oversized, state reason: \_\_\_\_\_

#### Chiller

Size category, if oversized, state reason: \_\_\_\_\_

List equipment efficiencies: SEE SCHEDULE(S)

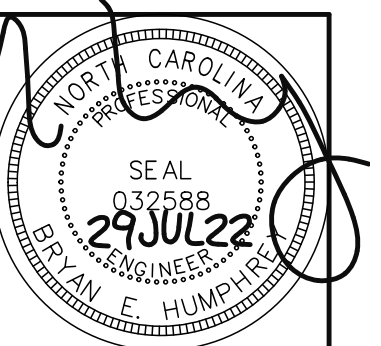

### REVISIONS

NO.	DESCRIPTION

THIS DRAWING AND ANY INSTRUMENTS OF SERVICE AND ANY PARTS THEREOF ARE THE PROPERTY OF THE ENGINEER. THESE INSTRUMENTS OF SERVICE AND ANY INSTRUMENTS OF SERVICE ARE TO BE KEPT IN THE OFFICE OF THE ENGINEER. ANY INSTRUMENTS OF SERVICE NOT KEPT IN THE OFFICE OF THE ENGINEER WILL BE DESTROYED AT THE ENGINEER'S DISCRETION.

**EUBANKS ENGINEERING P.C.**  
**HARNETT SELF STORAGE**  
102 Parsley St., Suite 200  
Greensboro, NC 27401  
Phone 336.379.0663  
Fax 336.379.0053

FIRM LICENSE: C-2272

BUILDING SYSTEMS PLANS FOR:

JOB NO. 2278  
ORIGINAL ISSUE DATE 29JUL22  
DRAWN BY JMK  
CHECKED BY BEH  
SHEET NO.

**M-1**



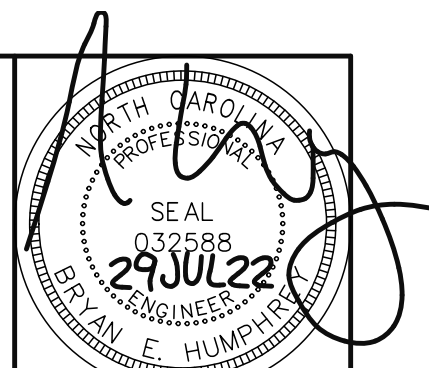

REVISIONS

THESE DRAWINGS ARE THE PROPERTY OF EUBANKS ENGINEERING PC. NO PART OF THESE DRAWINGS SHALL BE REPRODUCED OR TRANSMITTED IN ANY FORM OR BY ANY MEANS WITHOUT THE SPECIFIC WRITTEN CONSENT OF THE ENGINEER.

© 2022 EUBANKS ENGINEERING PC

**EUBANKS ENGINEERING PC**  
**HUMPHREY**  
 102 Paisley St., Suite 200  
 Greensboro, NC 27401  
 Phone: 336.379.0663  
 Fax: 336.379.0053

FIRM LICENSE: C-2272

BUILDING SYSTEMS PLANS FOR:

**HARNETT SELF STORAGE**  
 SPOUT SPRINGS, NC

JOB NO. 2278  
 ORIGINAL ISSUE DATE 29 JUL 22  
 DRAWN BY JMK  
 CHECKED BY BEH  
 SHEET NO.

**M-2**

OF 2

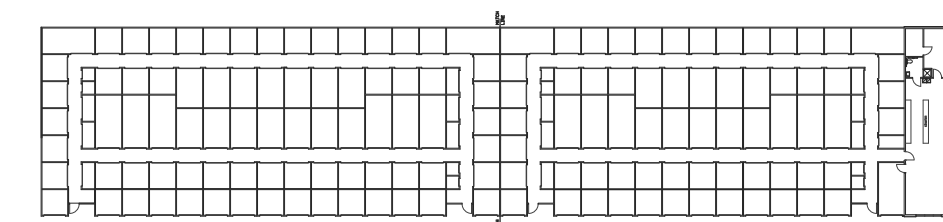

KEY PLAN  
NO SCALE

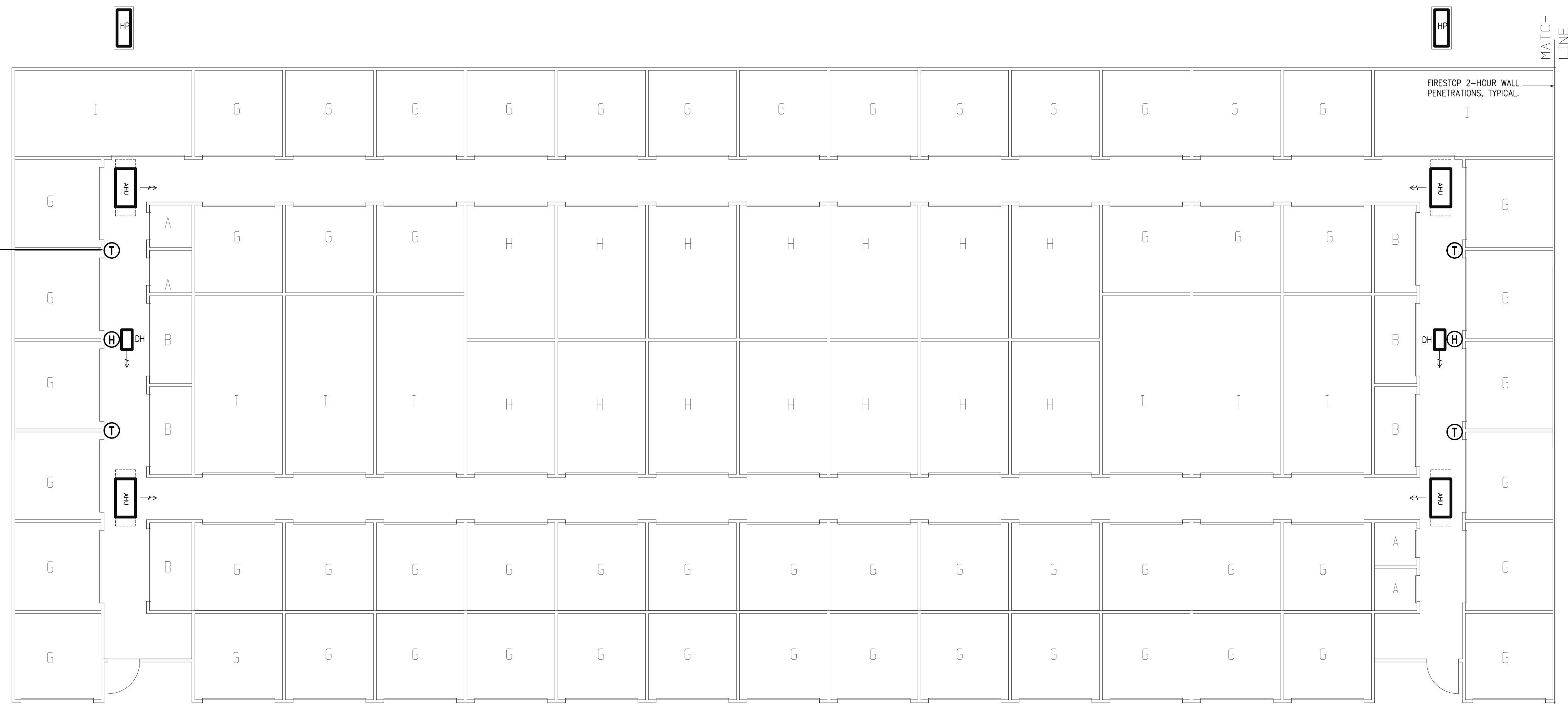

WIRED T'STAT IN VENTILATED LOCKING COVER, TYPICAL.

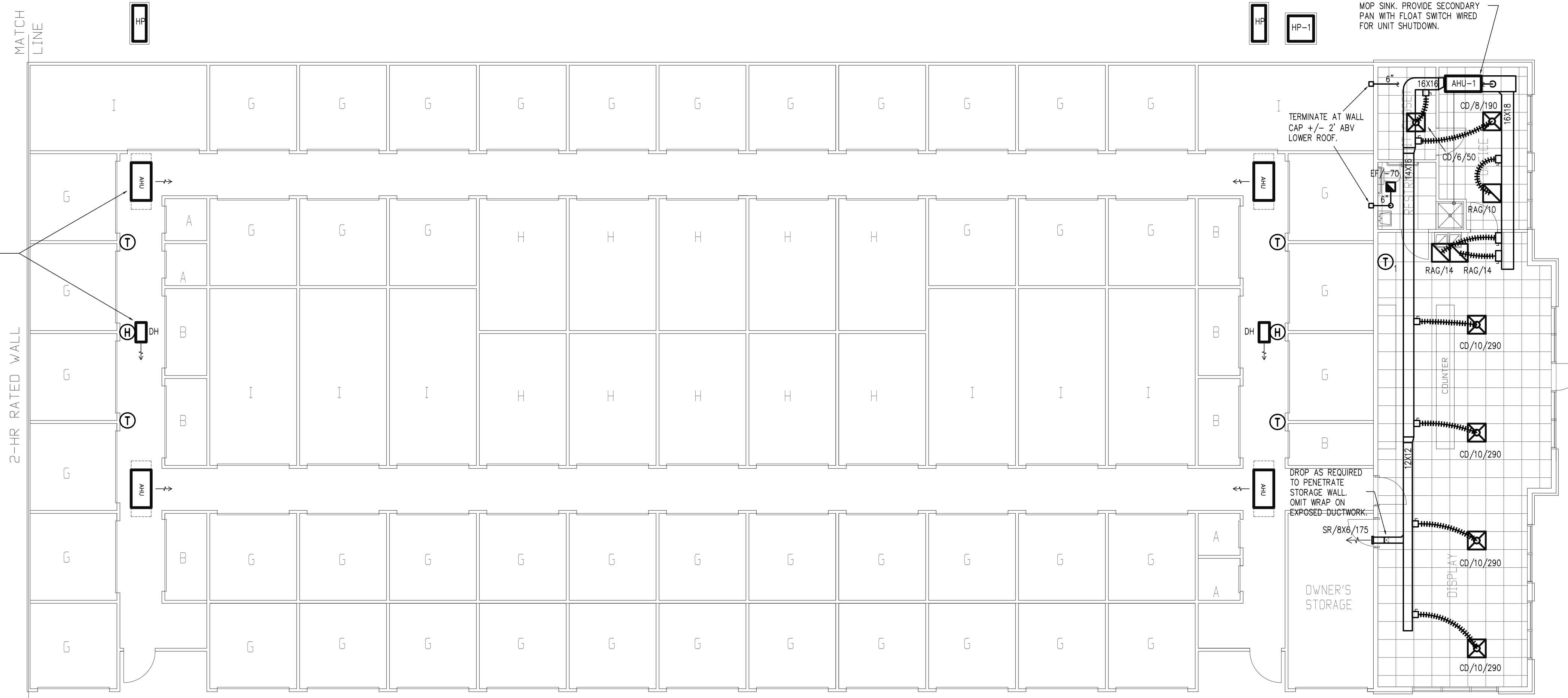

AIR HANDLERS AND DEHUMIDIFIERS SHALL BE PROVIDED WITH CONDENSATE PUMPS. A UL 508 WATER-LEVEL DETECTION DEVICE SHALL BE PROVIDED THAT WILL SHUT OFF THE EQUIPMENT IN THE EVENT THAT THE PRIMARY DRAIN IS BLOCKED. DISCHARGE CONDENSATE IN ACCORDANCE WITH LOCAL STANDARDS WHERE AS NOR TO CAUSE A NUISANCE. PROVIDE DRY WELL WHERE REQUIRED. TYPICAL.

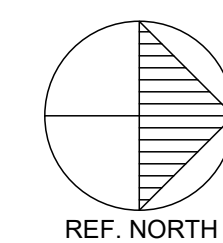

REF. NORTH

**HVAC PLAN**

SCALE: 1/8" = 1'-0"

## ABBREVIATIONS

DESCRIPTION	ABBREVIATION
ABOVE	ABV
AUTOMATIC DOOR OPENER	ADO
AMPERE FRAME	AF
AMPERE TRIP	AT
BARE COPPER	BC
ELECTRICAL CONDUIT	C
CIRCUIT BREAKER	CB, C/B
DIRECT BURIAL	DB
DENTAL EQUIPMENT SUPPLIER	DES
ELECTRICAL CONTRACTOR	EC
EQUIPMENT GROUND	EG
ELECTRIC WATER COOLER	EWC
FIRE ALARM	FA
FIRESTOP	FS
FUSED SAFETY SWITCH	FSS
GENERAL CONTRACTOR	GC
GROUND TERMINAL BOX	GTB
GROUND FAULT CIRCUIT INTERRUPTER	GFCI
LOCAL TEMPERATURE CONTROL PANEL	LTCP
LIGHT FIXTURES	LTS
MAIN DISTRIBUTION PANEL	MDP
MAIN LUGS ONLY	MC
MECHANICAL CONTRACTOR	MC
NON-FUSED SAFETY SWITCH	NFSS
NIGHT LIGHT	NL
PHOTO CELL	PC
PLUMBING CONTRACTOR	PCLL
POWER OPERATED DAMPER	POD
POWER TYPE ROOF VENTILATION	PTRV
RECEPTACLE	REC
SAFETY SWITCH	SS
TIME CLOCK	TC
WIRE	W
WEATHER PROOF IN USE	WP

## ELECTRICAL SYMBOL LEGEND

ONLY SYMBOLS USED ON PLANS APPLY.  
DIMENSIONS (+X) ARE TO TOP OF BOX

SYMBOL	DESCRIPTION
	CIRCUIT BREAKER PANEL BOARD
	CIRCUITRY, CONCEALED WHERE FEASIBLE 2 CONDUCTORS UNLESS INDICATED OTHERWISE BY HASH MARKS
	HOME RUN TO PANEL
	SAFETY DISCONNECT SWITCH, NEMA RATING AMPACITY AND FUSING AS REQUIRED
	120V DUPLEX GROUNDED RECEPTACLE, 18" AFF U.O.N WP = WEATHER PROOF U = DUAL USE PORTS IG = ISOLATED GROUND 120V
	120V DUPLEX GFCI RECEPTACLE, 18" AFF U.O.N
	QUADRAPLEX GROUNDED RECEPTACLE, 18" AFF U.O.N
	SPECIAL PURPOSE RECEPTACLE AS NOTED
	JUNCTION BOX
	EXHAUST FAN INSTALLED BY OTHERS
	DATA COMMUNICATIONS OUTLET, 18" AFF U.O.N (BOX, CONDUIT TO CLG SPACE ONLY)
	TELEPHONE OUTLET, 18" AFF U.O.N., (BOX, CONDUIT TO CEILING SPACE ONLY)
	TELEPHONE EQUIP. BACKBOARD, SIZE AS REQUIRED
	CABLE TV OUTLET, WIRE BACK TO SERVICE BOX.
	CIRCUITRY
	UNDERGROUND CIRCUITRY

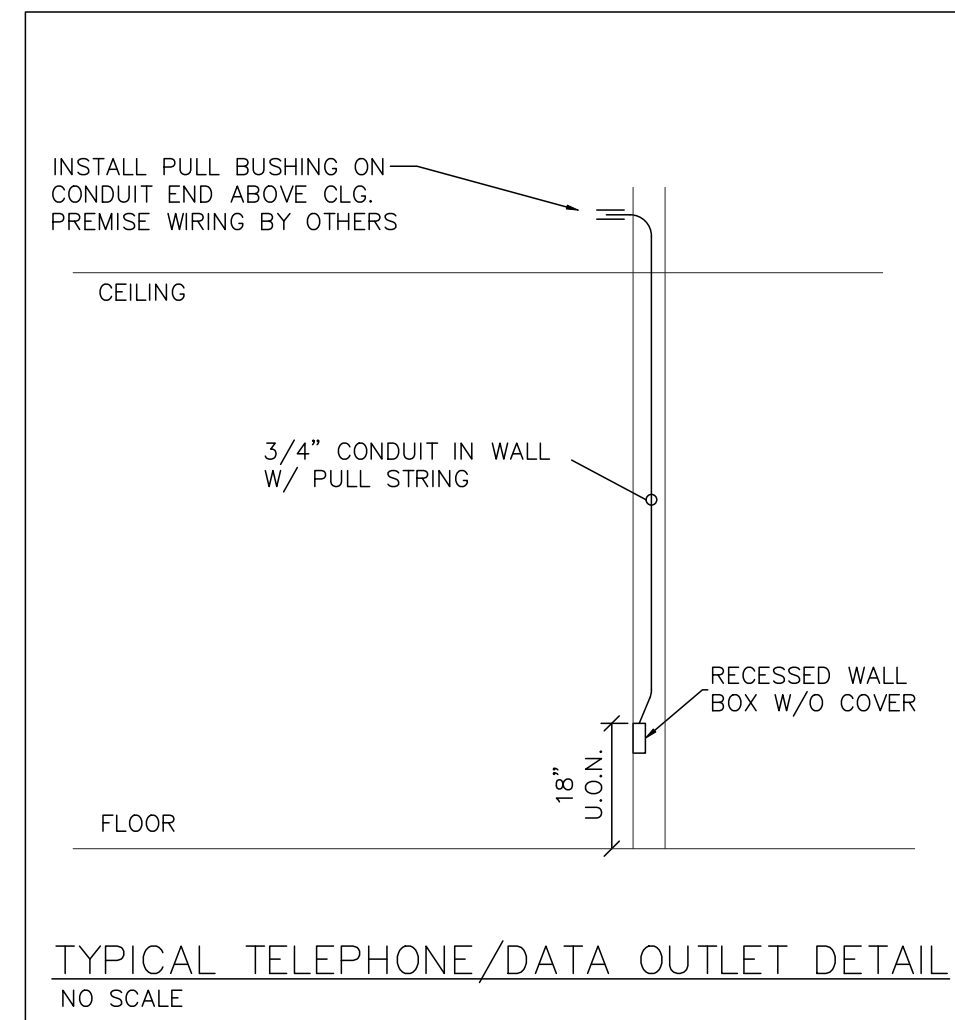
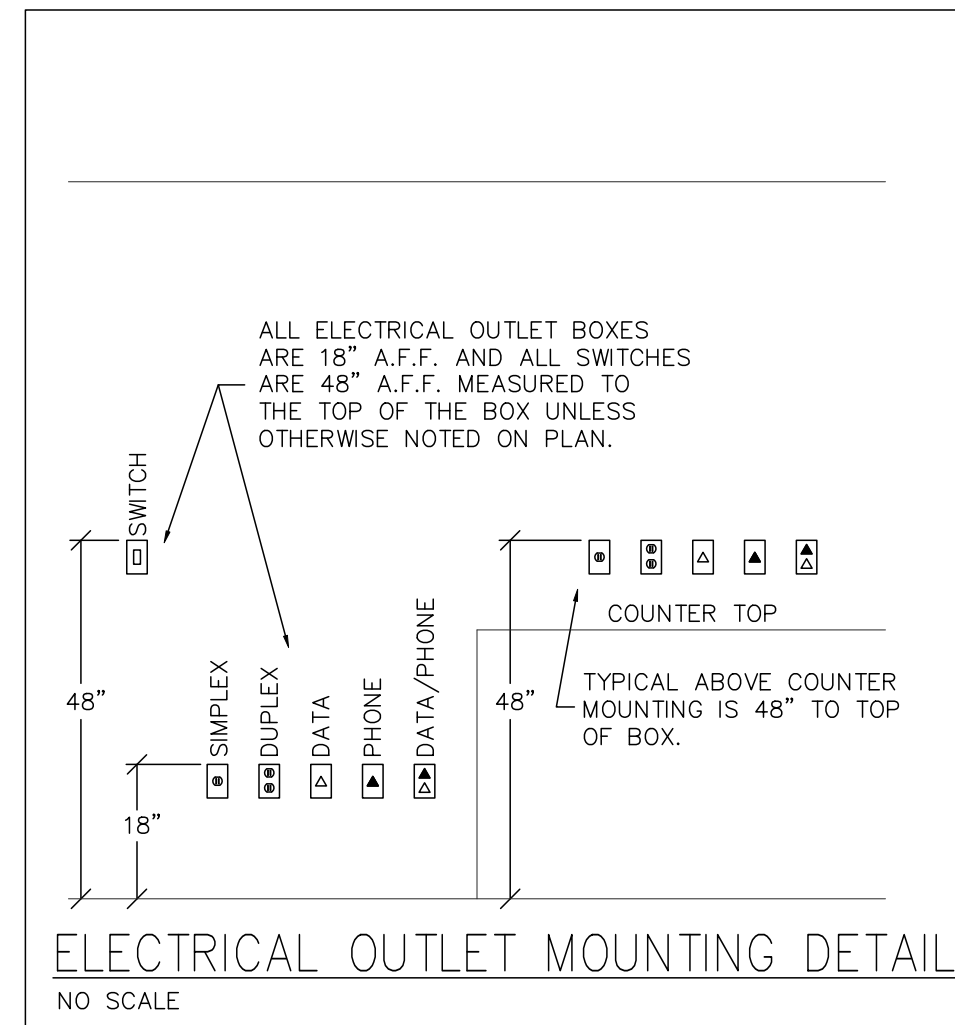

## LIGHTING SYMBOL LEGEND

ONLY SYMBOLS USED ON PLANS APPLY.  
DIMENSIONS (+X) ARE TO TOP OF BOX

SYMBOL	DESCRIPTION
	WALL MOUNTED LIGHT FIXTURE
	CEILING MOUNTED LIGHT FIXTURE
	2X4 LIGHT FIXTURE
	2X2 LIGHT FIXTURE
	BATTERY PACK EXIT SIGN
	BATTERY PACK EMERGENCY LIGHT
	BATTERY PACK COMBINATION EXIT/EMERGENCY LIGHT
	REMOTE EXIT DISCHARGE FIXTURE
	SWITCH 48" TO TOP AFF
	3-WAY SWITCH 48" TO TOP AFF
	4-WAY SWITCH 48" TO TOP AFF
	DIMMER SWITCH 48" TO TOP AFF
	SWITCH W/ PILOT LAMP
	HOME RUN TO PANEL
	CIRCUITRY
	UNSWITCHED CIRCUITRY
	WALL SWITCH OCCUPANCY SENSOR
	CEILING MOUNT OCCUPANCY SENSOR, 360° SENSOR VIEW.
	DIRECTIONAL CEILING/WALL MOUNT OCCUPANCY SENSOR

## SERVICE AND FEEDER LOAD SUMMARY

PER NEC ARTICLE 220

GROSS SQUARE FOOTAGE = 23,911					
LOAD	QUANTITY	RATE	LOAD (VA)	DEMAND FACTOR	DEMAND LOAD (VA)
LIGHTING (SORAGE)	22583 SF	.25 VA/SF	5645	1.25	7057
LIGHTING (OFFICE)	1328 SF	3.5 VA/SF	4648	1.25	5810
EXT. LIGHTING	NA	NA	2800	1.25	3500
SIGNAGE	2	1200VA/	2400	1.25	3000
RECEPTACLES	28	180VA/REC	5040	1.00	5040
HVAC	NA	NA	24480	1.00	24480
EMH	1	NA	1500	1.00	1500
KIT. EQUIP	NA	NA	0	0.65	0
TOTAL					50387
AMPERAGE @ 120/208V 3PH 4W					140A
SERVICE CONDUCTORS SPECIFIED					200A

2018 APPENDIX B BUILDING CODE SUMMARY FOR ALL COMMERCIAL PROJECTS	
ELECTRICAL design	
electrical summary	
<b>ELECTRICAL SYSTEM AND EQUIPMENT</b>	
Method of Compliance: Energy Code - Prescriptive	
Lighting schedule (each fixture type): lamp type required in fixture: VARIES number of lamps in fixture: VARIES ballast type used in the fixture: VARIES number of ballasts in fixture: VARIES total wattage per fixture: VARIES total interior wattage specified vs. allowed (whole building or space by space): total exterior wattage specified vs. allowed	
TOTAL INTERIOR WATTAGE SPECIFIED VS ALLOWED:	7,043 VS 13,505
WHOLE BUILDING ( ) SPACE BY SPACE (X)	
EXTERIOR LIGHTING WATTAGE SPECIFIED VS ALLOWED:	1,758 VS 3,459
Additional Efficiency Package Options (When using the 2018 NCECC; not required for ASHRAE 90.1)	
<input type="checkbox"/> C406.2 More Efficient HVAC Equipment Performance <input checked="" type="checkbox"/> C406.3 Reduced Lighting Power Density <input type="checkbox"/> C406.4 Enhanced Digital Lighting Controls <input type="checkbox"/> C406.5 On-Site Renewable Energy <input type="checkbox"/> C406.6 Dedicated Outdoor Air System <input type="checkbox"/> C406.7 Reduced Energy Use in Service Water Heating	

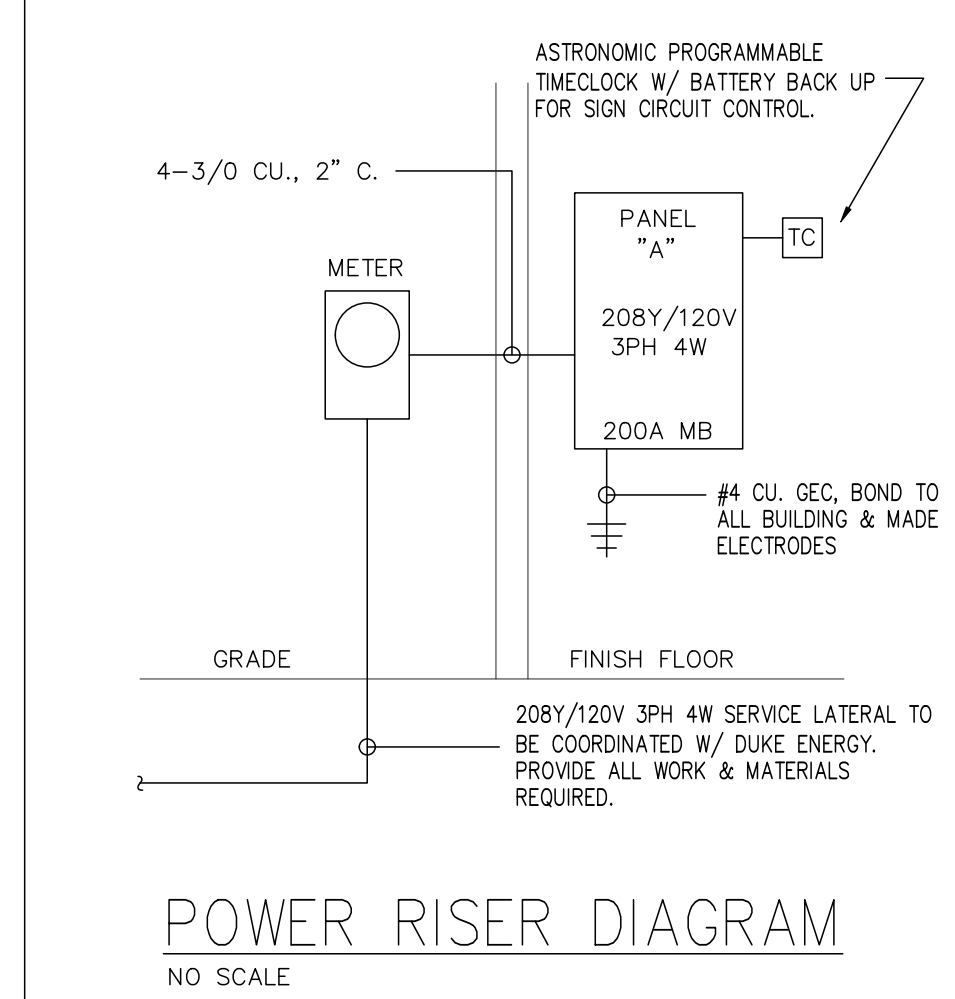

## ELECTRICAL SPECIFICATIONS

ALL WORK SHALL COMPLY WITH LAWS APPLYING TO ELECTRICAL INSTALLATIONS IN EFFECT, AND WITH THE MOST RECENT EDITION OF THE NATIONAL ELECTRICAL CODE, ADA, APPLICABLE SECTIONS OF OTHER NFPA, OSHA, LIFE SAFETY CODES AND RECOMMENDATIONS, AND THE INTERIM AMENDMENTS IN EFFECT AT THE TIME OF THE PROPOSAL.

THE WORK INCLUDES PROVIDING MATERIALS, DEVICES, WRING, FIXTURES, ETC. NECESSARY FOR A COMPLETE FUNCTIONING ELECTRICAL SYSTEM. ALL MATERIALS FURNISHED BY THE CONTRACTOR SHALL BE NEW AND UNUSED AND FREE FROM DEFECTS. INSTALL, CONNECT AND ADJUST ALL EQUIPMENT PER MANUFACTURER'S INSTRUCTIONS. ANY ITEM NOT SPECIFICALLY SHOWN ON THE DRAWINGS OR CALLED FOR IN THE SPECIFICATIONS, BUT THAT IS NORMALLY REQUIRED TO CONFORM TO THE INTENT, ARE TO BE CONSIDERED A PART OF THE CONTRACT. ALL MATERIALS USED SHALL BE NEW AND SHALL CONFORM TO THE STANDARDS ESTABLISHED BY THE UNDERWRITERS LABORATORIES INCORPORATED.

THE INTENT OF THE DRAWINGS IS TO INDICATE THE GENERAL EXTENT OF WORK REQUIRED FOR THE PROJECT. THE DRAWINGS FOR ELECTRICAL WORK ARE DIAGRAMMATIC, SHOWING THE LOCATION, TYPE, DEVICES AND EQUIPMENT REQUIRED. THE DRAWINGS SHALL NOT BE SCALED FOR EXACT MEASUREMENTS. PROVIDE ALL FIXTURES, DEVICES, ACCESSORIES, OFFSETS, AND MATERIALS NECESSARY TO FACILITATE THE SYSTEM'S FUNCTIONING AS INDICATED BY THE DESIGN AND THE EQUIPMENT FURNISHED BY OTHERS.

HOOK-UP CHARGES, PERMITS, LOCAL FEES AND ALL OTHER EXPENSES RELATED TO A COMPLETE AND FUNCTIONING ELECTRICAL SYSTEM SHALL BE INCLUDED IN THE CONTRACTORS BID. THE CONTRACTOR SHALL COOPERATE FULLY WITH UTILITY SERVICE PROVIDERS WITH RESPECT TO THEIR SERVICES.

COORDINATION: COORDINATE WITH THE WORK OF OTHER SECTIONS, EQUIPMENT FURNISHED BY OTHERS, REQUIREMENTS OF THE OWNER, AND WITH THE CONSTRAINTS OF THE EXISTING CONDITIONS OF THE PROJECT SITE. ANY WORK THAT IS INSTALLED BY THIS CONTRACTOR THAT RESULTS IN CONFLICT, DUE TO LACK OF COORDINATION BETWEEN TRADES, SHALL BE CHANGED AS DIRECTED BY THE ARCHITECT/ENGINEER WITHOUT ADDITIONAL COMPENSATION TO THE CONTRACTOR.

COORDINATE WITH THE LOCAL ELECTRIC UTILITY COMPANY AND TELEPHONE COMPANY AS TO THE REQUIREMENTS FOR SERVICE CONNECTIONS AND PROVIDE ALL LABOR, MATERIALS, AND TESTING NECESSARY.

DEFINITIONS: FURNISH MEANS TO SUPPLY AND DELIVER TO PROJECT SITE, READY FOR INSTALLATION. INSTALL MEANS TO PLACE IN POSITION AND MAKE CONNECTIONS FOR SERVICE OR USE. PROVIDE MEANS TO FURNISH AND INSTALL, COMPLETE AND READY FOR INTENDED USE. WIRING MEANS THE INCLUSION OF ALL RACEWAYS, FITTINGS, CONDUCTORS, CONNECTORS, JUNCTION AND OUTLET BOXES, SPLICES, CONNECTIONS, TAPE, AND ALL OTHER ITEMS NECESSARY AND/OR REQUIRED IN CONNECTION WITH SUCH WORK. CONDUIT MEANS THE INCLUSION OF ALL HANGERS, SUPPORTS, FITTINGS, ETC.

FIRESTOPPING IS A MATERIAL OR COMBINATION OF MATERIALS USED TO RETAIN INTEGRITY OF FIRE-RATED CONSTRUCTION BY MAINTAINING AN EFFECTIVE BARRIER AGAINST THE SPREAD OF FLAME, SMOKE, AND HOT GASES THROUGH PENETRATIONS IN FIRE RATED WALL AND FLOOR ASSEMBLIES.

WARRANTY: PROVIDE LABOR AND MATERIALS TO REPAIR OR REPLACE DEFECTIVE PARTS AND MATERIALS AS REQUIRED FOR ONE YEAR AFTER SUBSTANTIAL COMPLETION OR OWNER ACCEPTANCE OF THE COMPLETED PROJECT.

ELECTRICAL DESIGN HAS BEEN BASED ON THE INSTALLATION OF 75°C CONDUCTORS CONNECTED TO TERMINAL LUGS AND EQUIPMENT, U.L. LISTED FOR A MINIMUM 75°C. CONDUCTORS TERMINATED ON EQUIPMENT OR DEVICES WITH A LOWER RATING (60°C) OR NO RATING SHOWN, SHALL HAVE CONDUCTOR SIZE INCREASED TO CONFORM TO NEC TABLE 310-16.

ALL EQUIPMENT SHALL BE EQUAL TO OR EXCEED THE MINIMUM REQUIREMENTS OF NEMA, IEEE, AND IUL.

DISCONNECT SWITCHES SHALL BE HEAVY-DUTY, QUICK-MAKE, QUICK-BREAK TYPE, NEMA 1 ENCLOSURE FOR INDOOR LOCATIONS (NEMA 3R FOR OUTDOOR LOCATIONS). SWITCHES SHALL BE AS MANUFACTURED BY SQUARE 'D', GENERAL ELECTRIC, OR SIEMEN'S (I.T.E.). PROVIDE FUSES AS MANUFACTURED BY BUSSMAN, GOULD-SHAWMUT, OR LITTLE-FUSE. ALL CONDUCTOR TERMINALS TO BE U.L. LISTED FOR A MINIMUM OF 75°C. SWITCHES USED AS SERVICE ENTRANCE EQUIPMENT TO BE U.L. LISTED AS "SER" RATED EQUIPMENT. WHERE MULTIPLE DISCONNECTS ARE USED AS A SERVICE ENTRANCE MEANS, A NEUTRAL CONDUCTOR SHALL BE RUN TO THE NEUTRAL TERMINAL IN EACH SERVICE DISCONNECT AND SHALL BE BONDED PER NEC.

PANEL BOARDS SHALL BE AS MANUFACTURED BY SQUARE-D OR EQUAL MEETING U.L. STANDARDS 50 AND 67, WITH U.L. LABEL. PANELS USED AS SERVICE ENTRANCE EQUIPMENT TO BE U.L. LISTED AS "SER" RATED EQUIPMENT. PANELBOARDS SHALL BE FULLY RATED.

BREAKERS: THERMAL MAGNETIC TYPE, QUICK-MAKE, QUICK-BREAK, PLUG-IN TYPE OF SINGLE UNIT CONSTRUCTION. TWO POLE BREAKERS SHALL BE SINGLE UNIT COMMON TRIP TYPE. BREAKERS USED AS SWITCHES FOR 120V LIGHTING CIRCUITS SHALL BE APPROVED FOR THAT USE AND MARKED "SMO".

GROUNDING SYSTEM: PERMANENTLY AND EFFECTIVELY GROUND ALL METALLIC CONDUIT, SUPPORTS, CABINETS, PANELBOARDS AND SYSTEM NEUTRAL CONDUCTORS. MAINTAIN CONTINUITY OF EQUIPMENT GROUND THROUGHOUT THE SYSTEM. GROUND CLAMPS SHALL BE APPROVED TYPE, SPECIFICALLY DESIGNED FOR GROUNDING, WHERE GROUNDING CONDUCTOR IS ENCLOSED IN CONDUIT, GROUND CLAMP SHALL BE OF A TYPE WHICH GROUNDS BOTH CONDUCTOR AND CONDUIT. ALL CIRCUITS IN FLEXIBLE METAL OR PLASTIC CONDUIT SHALL INCLUDE A GROUND WIRE SIZED IN ACCORDANCE WITH NATIONAL ELECTRICAL CODE.

CONDUCTORS: INSULATED SOFT ANNEALED 98% PURE COPPER WITH COLOR CODING, B AND S GAGE, #10 AND SMALLER TO BE SOLID, #8 AND LARGER TO BE STRANDED, MINIMUM #12 UNLESS OTHERWISE INDICATED. CONDUCTORS MUST BE INSTALLED IN ACCORDANCE WITH N.E.C. AND CANNOT BE SUPPORTED FROM CEILING SUPPORT WIRES. THIN MAY NOT BE USED UNDERGROUND, AT SERVICE ENTRANCE, OUTSIDE, OR IN WET LOCATIONS. ALL INSULATION TO BE RATED FOR 600 V.

LIGHT FIXTURES & LAMPS ARE TO BE FURNISHED BY E.C. AS NOTED ON THE LIGHT FIXTURE SCHEDULE. FIXTURE INSTALLATION SHALL BE BY THE ELECTRICAL CONTRACTOR ACCORDING TO LOCAL CODE AUTHORITY. THE ELECTRICAL CONTRACTOR SHALL REVIEW MATERIALS AT THE TIME OF DELIVERY AND IMMEDIATELY REPORT ANY DAMAGE OR MISSING PIECES.

LIGHT FIXTURE QUANTITIES AND INPUT WATTAGES LISTED IN LIGHT FIXTURE SCHEDULE ARE FOR ENGINEERING ENERGY CALCULATIONS ONLY AND ARE NOT TO BE USED BY CONTRACTOR FOR QUANTITY TAKE-OFFS.

EMERGENCY LIGHTING SHALL HAVE A MINIMUM OF 90 MIN. BATTERY BACK-UP, OR AS REQUIRED BY LOCAL CODE AUTHORITY.

LAYOUT BRANCH CIRCUIT WIRING AND ARRANGEMENT OF HOME RUNS FOR MAXIMUM ECONOMY AND EFFICIENCY. INCREASE WIRE SIZE IF VOLTAGE DROP EXCEEDS 3% OR 100 FEET OF LENGTH.

CONCEAL WIRING SYSTEM ABOVE SUSPENDED CEILINGS OR IN WALL OR FLOOR CONSTRUCTION WHERE POSSIBLE. INSTALL CONDUITS PARALLEL TO BUILDING LINES, AND TO CLEAR ALL OPENING, DEPRESSIONS, PIPES, DUCTS, STRUCTURE, ETC.

ALL WIRING SHALL BE IN CONDUIT, UNLESS SPECIFICALLY NOTED OTHERWISE.

INSTALL CONDUIT CONTINUOUS BETWEEN BOXES AND CABINETS WITH NO MORE THAN FOUR (4) 90 DEGREE BENDS. SECURELY FASTEN IN PLACE WITH STRAPS, HANGERS AND STEEL SUPPORTS AS REQUIRED. DO NOT SUPPORT CONDUIT FROM SUSPENDED CEILING GRID OR SUSPENSION WIRES. REAM CONDUIT ENDS BEFORE INSTALLATION AND THOROUGHLY CLEAN BEFORE INSTALLATION. OPENINGS SHALL BE PLUGGED OR COVERED TO KEEP CONDUIT CLEAN.

CONDUIT SHALL BE SIZED TO COMPLY WITH NEC FOR NUMBER AND SIZE OF CONDUCTORS INSTALLED, MINIMUM 24" BELOW GRADE. PROVIDE SCHEDULE 40 PVC PLASTIC OR RIGID STEEL CONDUIT BELOW GRADE, MINIMUM 3/4". PROVIDE ELECTRICAL METAL TUBING (EMT), FLEXIBLE METAL CONDUIT (N LENGTHS 6' OR LESS) FOR INTERIOR LOCATIONS. EMT CONNECTORS AND COUPLING SHALL BE SET-SCREW TYPE. CLAMP CONDUIT TO BOXES WITH BUSHING INSIDE AND LOCKNUT OUTSIDE.

BELOW GRADE RACEWAYS SHALL BE CONSIDERED WET LOCATION AND SHALL BE SEALED PER NEC 300.5 (G) WITH A SEALANT IDENTIFIED FOR USE WITH INSTALLED CONDUCTORS/INSULATION. "MC" TYPE CABLES MAY BE USED IN SPACES WHERE NOT SUBJECT TO PHYSICAL DAMAGE OR CORROSION. "MC" & "AC" CABLE MUST BE INSTALLED IN A WORKMANLIKE MANNER AND PERPENDICULAR OR PARALLEL TO BUILDING LINES. CABLE MUST BE INSTALLED IN ACCORDANCE WITH N.E.C. ARTICLE 330.

ALL CONDUIT AND RACEWAY SYSTEMS SHALL BE INSTALLED WITH SEPARATE GROUND CONDUCTOR. CONDUIT SYSTEM IS NOT TO BE USED AS THE SOLE GROUNDING MEANS.

TOUCH UP OR REFINISH DAMAGED SURFACES OF FIXTURES AND EQUIPMENT, EXPOSED TO VIEW.

DATA & TELEPHONE PREMISES WIRING & CABLES TO BE FURNISHED AND INSTALLED BY OWNER. RACEWAY AND/OR CONDUIT TO BE PROVIDED BY E.C. VERIFY EXACT MOUNTING LOCATIONS WITH ARCHITECT PRIOR TO FASTENING RACEWAY OR CONDUIT TO WALL, CEILING OR FLOOR. FASTEN TO SURFACE AS RECOMMENDED BY MANUFACTURER. MOUNT SO RACEWAY IS IN THE LEAST OBVIOUS LOCATION. REAM ALL CUTS SMOOTH. PROVIDE ALL REQUIRED BOXES, EXTENSIONS, FITTINGS, ELBOWS AND DEVICES FOR A COMPLETE INSTALLATION.

REFER TO ARCHITECTURAL REFLECTED CEILING PLAN FOR EXACT LOCATION OF LIGHTING FIXTURES AND OTHER CEILING MOUNTED EQUIPMENT.

FOR EQUIPMENT FURNISHED BY OWNER OR OTHER CONTRACTORS, ELECTRICAL CONTRACTOR TO VERIFY EXACT LOAD, TYPE OF CONNECTION AND MOUNTING HEIGHT FOR EACH BOX OR EQUIPMENT ITEM TO BE INSTALLED. ALL HARDWIRED CONNECTIONS TO EQUIPMENT TO BE MADE WITH FLEXIBLE LIQUID-TITE METAL CONDUIT WITH GREEN GROUND CONDUCTOR INSTALLED INSIDE RACEWAY. GROUND CONDUCTOR SHALL BE BONDED AT BOTH ENDS.

COORDINATE ALL REQUIRED ROOF AND WALL OPENINGS WITH THE GENERAL CONTRACTOR. PROVIDE ALL CURBS, FLASHING, SLEEVES, SUPPORTING FRAMES, REINFORCING ANGLES, ETC. WHICH ARE REQUIRED UNLESS DIRECTED OTHERWISE.

MINIMUM WIRE SIZE - 20 AMP BRANCH CIRCUIT SHALL BE AWG LISTED SIZE PER DISTANCE SHOWN BELOW. DISTANCE SHALL BE MEASURED FROM THE PANELBOARD CIRCUIT BREAKER TO THE FURTHEST OUTLET ALONG THE CIRCUIT PATH.

- A. #12 LESS THAN 100 FEET
- B. #10 BETWEEN 100-150 FEET
- C. #8 BETWEEN 150 - 250 FEET
- D. #6 OVER 250 FEET

ON ALL 20 AMP BRANCH CIRCUITS, CONDUCTORS LARGER THAN #10 AWG SHALL BE REDUCED TO #10 AWG WITHIN 10 FEET OF PANEL BOARD AND DEVICE IN JUNCTION BOXES ON RATED TERMINAL STRIPS.

ALUMINUM CONDUCTORS ARE NOT PERMITTED, EXCEPT AT SERVICE ENTRANCE. CONDUCTOR CONNECTION MUST BE PER MANUFACTURER'S REQUIREMENTS.

# ELECTRICAL SYMBOLS, DETAILS & NOTES

NO SCALE

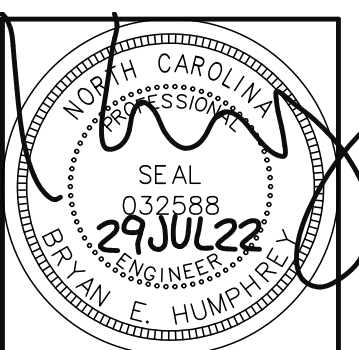

## REVISIONS

NO.	DESCRIPTION

THIS DRAWING AND ITS INSTRUMENTS OF SERVICE AND SEAL SHALL BE THE PROPERTY OF THE ENGINEER. THESE INSTRUMENTS AND SEAL SHALL NOT BE LOANED, REPRODUCED, COPIED, OR IN ANY MANNER USED FOR ANY OTHER PROJECT WITHOUT THE WRITTEN CONSENT OF THE ENGINEER.

© 2022 EUBANKS ENGINEERING P.C.

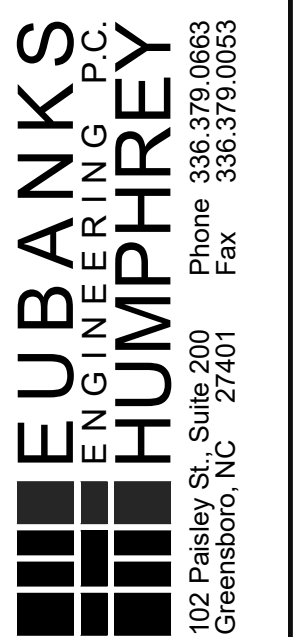

FIRM LICENSE: C-2272

BUILDING SYSTEMS PLANS FOR:

**HARNETT SELF STORAGE**  
SPOUT SPRINGS, NC

JOB NO.  
2278

ORIGINAL ISSUE DATE  
29JUL22

DRAWN BY  
JMK

CHECKED BY  
BEH

SHEET NO.

**E-1**

OF 5



NOTE: OCCUPANCY SENSOR LAYOUT IS SCHEMATIC & INTENDED TO INDICATE CONTROL ZONES. COORDINATE SELECTION, QUANTITIES & LOCATION WITH SENSOR SUPPLIER AS REQUIRED TO CONTROL THE INDICATED ZONES. COORDINATE INSTALLATION WITH OTHER TRADES. PROVIDE ALL WORK REQUIRED FOR A COMPLETE INSTALLATION. ACCEPTABLE MANUFACTURERS ARE WATTSTOPPER, LEGRAND, LUTRON, LEVITON OR HUBBELL. CONTRACTOR'S WORK TO INCLUDE ALL LABOR & MATERIALS NECESSARY FOR AND INCIDENTAL TO THE DELIVERY, INSTALLATION AND FURNISHING OF A COMPLETELY OPERATIONAL OCCUPANCY SENSOR LIGHTING CONTROL SYSTEM. MAKE ALL ADJUSTMENTS REQUIRED TO CONTROL INDICATED ZONES. AVOID INSTALLING SENSORS WITHIN 8' OF AIR HANDLERS, DEHUMIDIFIERS OR AIR VENTS.

EMERGENCY/EXIT BATTERY PACK FIXTURES TO BE CONNECTED TO LOCAL INTERIOR LIGHTING CIRCUIT AHEAD OF SWITCHING OR OTHER CONTROL DEVICE, TYPICAL

FIRESTOP 2-HOUR WALL PENETRATIONS, TYPICAL.

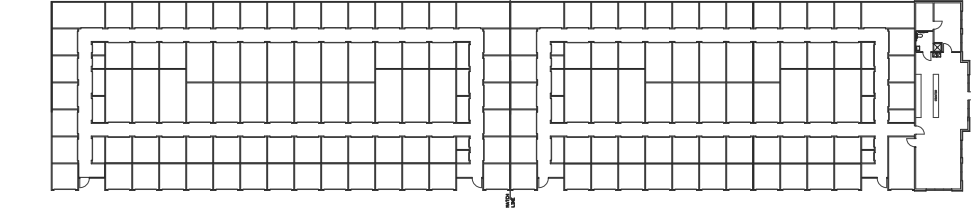
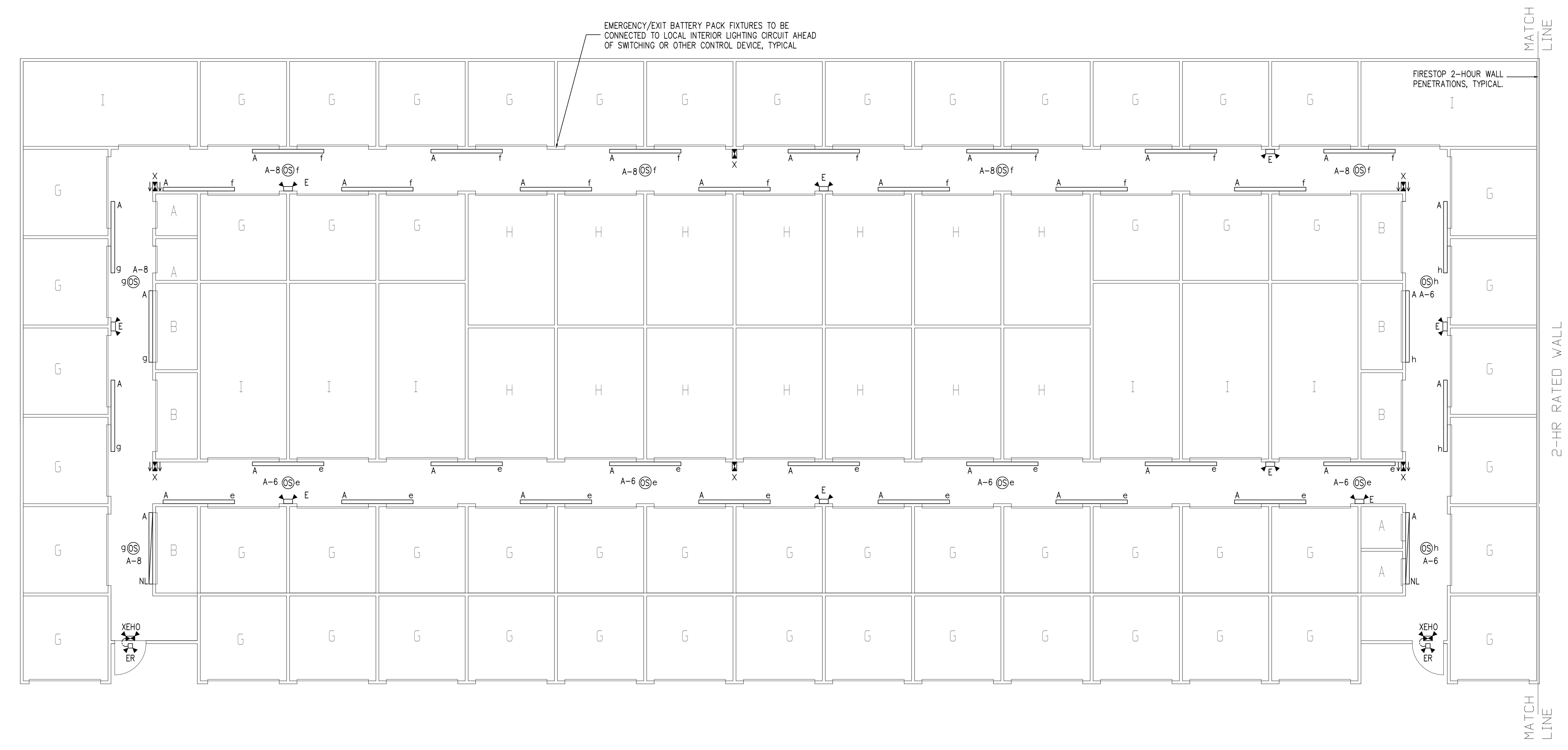

KEY PLAN  
NO SCALE

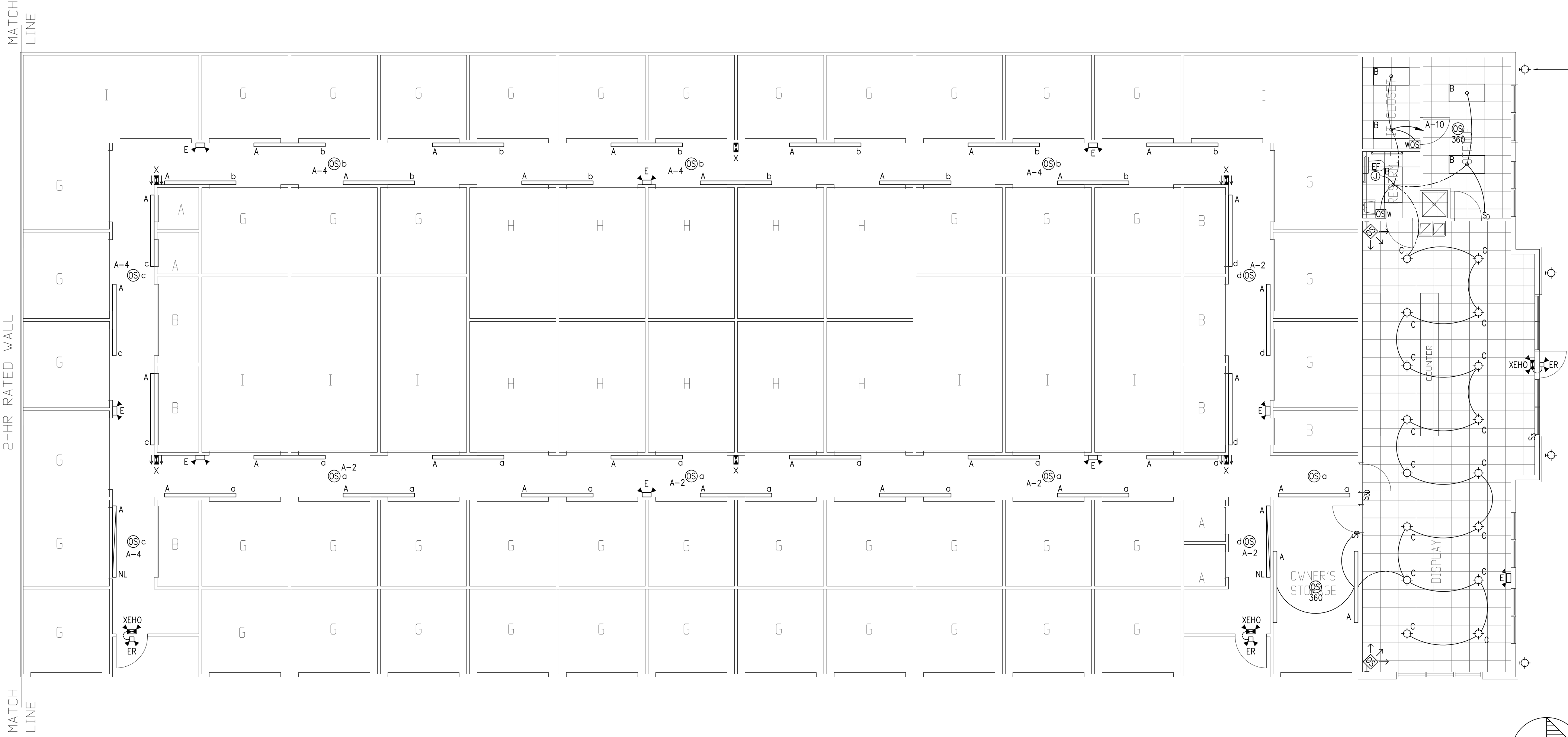

SEE AREA LIGHTING PLAN, TYPICAL.

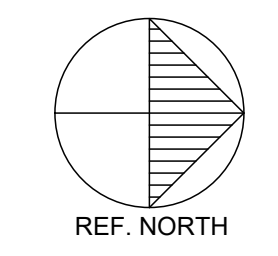

# LIGHTING PLAN

SCALE: 1/8" = 1'-0"

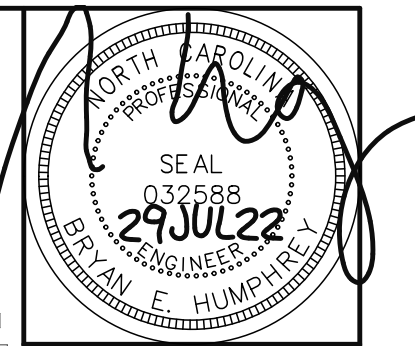

NO.	REVISIONS

THESE DRAWINGS AND PHOTOGRAPHS OF RECORD ARE THE PROPERTY OF THE ENGINEER. THEY ARE NOT TO BE REPRODUCED OR TRANSMITTED IN ANY FORM OR BY ANY MEANS, ELECTRONIC OR MECHANICAL, INCLUDING PHOTOCOPYING, RECORDING, OR BY ANY INFORMATION STORAGE AND RETRIEVAL SYSTEM, WITHOUT THE WRITTEN CONSENT OF THE ENGINEER.

**EUBANKS  
ENGINEERING  
P.C.  
HUMPHREY**  
102 Pateley St., Suite 200  
Greensboro, NC 27401  
Phone 336.379.0683  
Fax 336.379.0683

FIRM LICENSE: C-2272

BUILDING SYSTEMS PLANS FOR:  
**HARNETT SELF STORAGE**  
SPOUT SPRINGS, NC

JOB NO. 2278  
ORIGINAL ISSUE DATE 29JUL22  
DRAWN BY JMK  
CHECKED BY BEH  
SHEET NO.

**E-3**

OF 5

# ELECTRICAL FOR BUILDINGS 1/A,2/B10/J

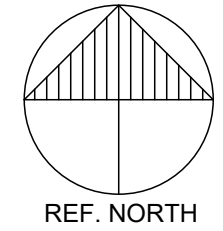
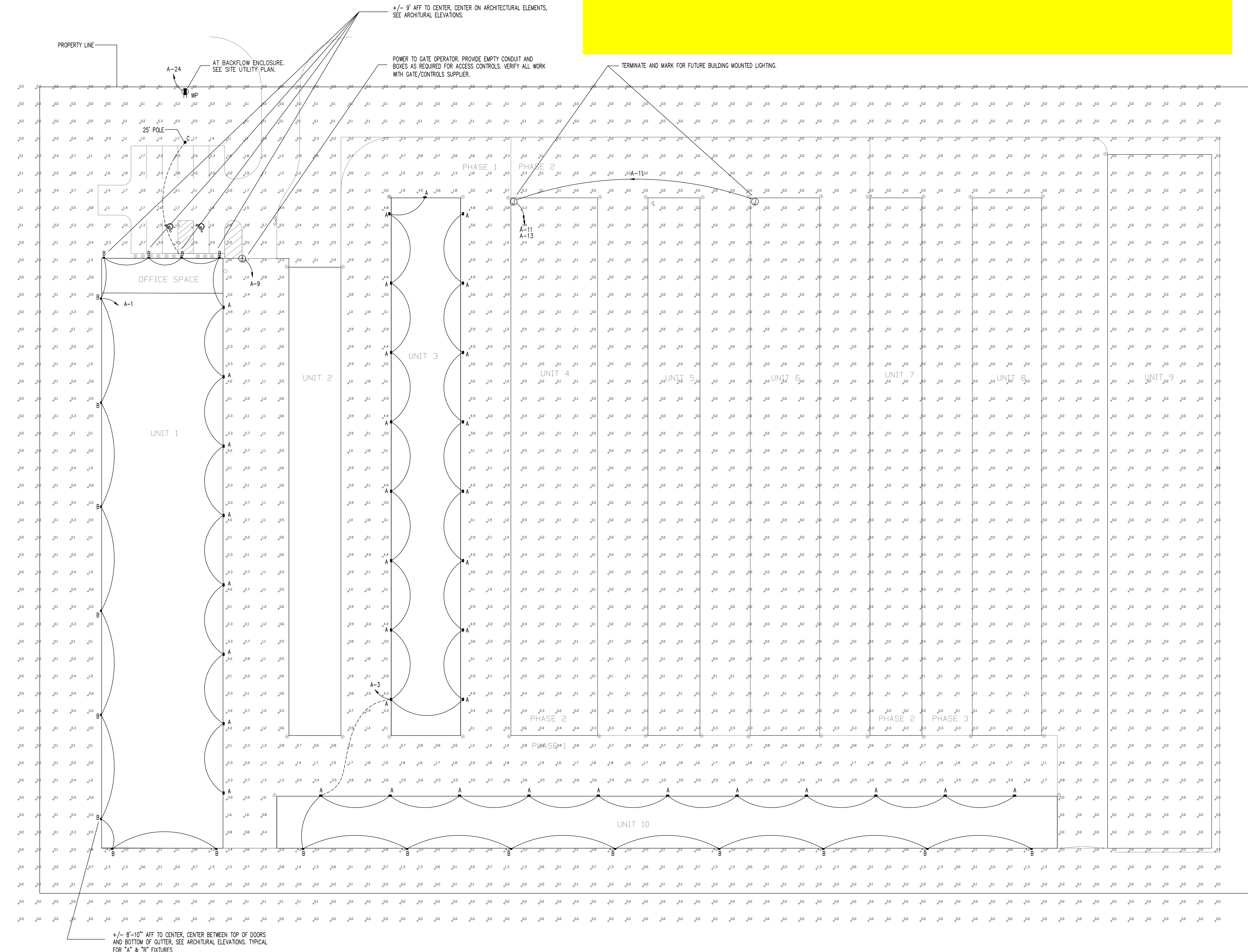

## AREA LIGHTING & SITE ELECTRICAL PLAN

SCALE: 1" = 30'-0"

### "A" FIXTURE

**TWH LED Wall Luminaire**

Control: [ ]  
Finish: [ ]  
Mount: [ ]

**Specifications**

- Width: 16.5" (417mm)
- Height: 15.5" (393mm)
- Depth: 6" (152mm)
- Weight: 20 lbs (9.1kg)

**Capable Luminaire**

This item is an Ac Capable luminaire, which has been designed and tested to provide consistent color temperature and system-level interoperability.

- All configurations of this luminaire meet the Acuity Brands' specification for chromatic consistency.
- This luminaire is Ac-Capable when ordered with DTL+ equipped luminaire meet the Ac-Capable specification for luminaire to photometric interoperability?
- This luminaire is part of an Ac-Capable solution for RDM/AMP or 900MHz Wireless control networks, providing out-of-the-box control compatibility with simple commissioning, when ordered with discrete and control options marked by a **PHOTOCENT** designation.

To learn more about Ac, visit [www.acincubator.com/ac](http://www.acincubator.com/ac)

1. See ordering tree for details.  
2. Ac-Capable Solutions for RDM/AMP require the order of one RDM/AMP node per luminaire. Sold Separately. Link to RDM/AMP: [Link to RDM/AMP](#)

**Ordering Information**

EXAMPLE: TWH LED 300 1000 50K TMM MVOLT DBDK

Order	SKU	Description	Configuration	Finish	Mount	Control	Weight	Notes
1	TWH300	300mm x 1000mm LED Wall Luminaire	50K TMM MVOLT DBDK	Black	Wall	None	20 lbs	

**Accessories**

DTL+ Ac-Capable Luminaire  
DTL+ Ac-Capable Luminaire  
DTL+ Ac-Capable Luminaire  
DTL+ Ac-Capable Luminaire  
DTL+ Ac-Capable Luminaire  
DTL+ Ac-Capable Luminaire  
DTL+ Ac-Capable Luminaire  
DTL+ Ac-Capable Luminaire

**LITHONIA LIGHTING** COMMERCIAL OUTDOOR One Lithonia Way • Canton, Georgia 30137 • Phone: 404.955.5878 • [www.lithonia.com](http://www.lithonia.com) TWH LED 300 1000 50K TMM MVOLT DBDK ©2019 Lithonia Lighting Inc. All rights reserved.

### "B" FIXTURE

**WPX LED Wall Packs**

Control: [ ]  
Finish: [ ]  
Mount: [ ]

**Specifications**

- Width: 16.5" (417mm)
- Height: 15.5" (393mm)
- Depth: 6" (152mm)
- Weight: 20 lbs (9.1kg)

**Introduction**

The WPX LED wall packs are energy-efficient, cost-effective, and aesthetically appealing solutions for both HID wall pack replacement and new construction applications. Available in three sizes, the WPX family delivers 1,350 to 9,200 lumens with a wide, uniform distribution.

The WPX full-out solutions fully cover the footprint of the HID glass wall packs that they replace, providing a neat installation and an upgraded appearance. Solid-state LED construction and excellent LED lumen maintenance ensure a long service life. Photocell and emergency egress battery options make WPX ideal for every wall-mounted lighting application.

**Ordering Information**

EXAMPLE: WPX LED 40K WVOL DBDK

Order	SKU	Description	Configuration	Finish	Mount	Control	Weight	Notes
1	WPX40K	40K LED Wall Pack	WVOL DBDK	Black	Wall	None	20 lbs	

**FEATURES & SPECIFICATIONS**

**INTRODUCTION**

The WPX LED wall packs are energy-efficient, cost-effective, and aesthetically appealing solutions for both HID wall pack replacement and new construction applications. Available in three sizes, the WPX family delivers 1,350 to 9,200 lumens with a wide, uniform distribution.

The WPX full-out solutions fully cover the footprint of the HID glass wall packs that they replace, providing a neat installation and an upgraded appearance. Solid-state LED construction and excellent LED lumen maintenance ensure a long service life. Photocell and emergency egress battery options make WPX ideal for every wall-mounted lighting application.

**INSTALLATION**

WPX LED wall packs are designed to be installed in a standard 1/2" x 1/2" hole. The WPX LED wall packs are designed to be installed in a standard 1/2" x 1/2" hole. The WPX LED wall packs are designed to be installed in a standard 1/2" x 1/2" hole.

**LITHONIA LIGHTING** COMMERCIAL OUTDOOR One Lithonia Way • Canton, Georgia 30137 • Phone: 404.955.5878 • [www.lithonia.com](http://www.lithonia.com) WPX LED 40K WVOL DBDK ©2019 Lithonia Lighting Inc. All rights reserved.

### "C" FIXTURE

**CSX1 LED Area Luminaire**

Control: [ ]  
Finish: [ ]  
Mount: [ ]

**Specifications**

- Length: 37.5" (953mm)
- Width: 15.5" (393mm)
- Height: 3" (76mm)
- Weight: 37 lbs (16.8kg)

**Capable Luminaire**

This item is an Ac Capable luminaire, which has been designed and tested to provide consistent color temperature and system-level interoperability.

- All configurations of this luminaire meet the Acuity Brands' specification for chromatic consistency.
- This luminaire is Ac-Capable when ordered with DTL+ controls marked by a **PHOTOCENT** designation.
- This luminaire is part of an Ac-Capable solution for RDM/AMP or 900MHz Wireless control networks, providing out-of-the-box control compatibility with simple commissioning, when ordered with discrete and control options marked by a **PHOTOCENT** designation.

To learn more about Ac, visit [www.acincubator.com/ac](http://www.acincubator.com/ac)

1. See ordering tree for details.  
2. Ac-Capable Solutions for RDM/AMP require the order of one RDM/AMP node per luminaire. Sold Separately. Link to RDM/AMP: [Link to RDM/AMP](#)

**Ordering Information**

EXAMPLE: CSX1 LED 40K 1000 40K TMM MVOLT SPA DBDK

Order	SKU	Description	Configuration	Finish	Mount	Control	Weight	Notes
1	CSX140K	40K LED Area Luminaire	1000 40K TMM MVOLT SPA DBDK	Black	Recessed	None	37 lbs	

**WITH PHOTOCENT CONTROL**

**LITHONIA LIGHTING** COMMERCIAL OUTDOOR One Lithonia Way • Canton, Georgia 30137 • Phone: 404.955.5878 • [www.lithonia.com](http://www.lithonia.com) CSX1 LED 40K 1000 40K TMM MVOLT SPA DBDK ©2019 Lithonia Lighting Inc. All rights reserved.

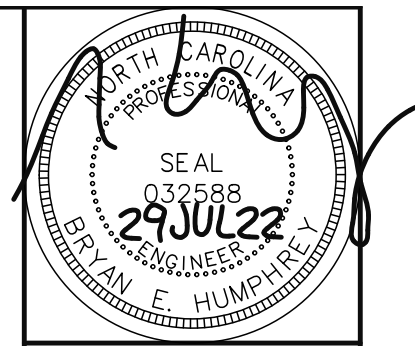

REVISIONS

NO.	DATE	DESCRIPTION

THESE DRAWINGS AND THE PORTIONS OF REFERENCE AND SPECIFICATIONS ARE THE PROPERTY OF THE ENGINEER. THESE DRAWINGS ARE NOT TO BE REPRODUCED OR TRANSMITTED IN ANY FORM OR BY ANY MEANS, ELECTRONIC OR MECHANICAL, INCLUDING PHOTOCOPYING, RECORDING, OR BY ANY INFORMATION STORAGE AND RETRIEVAL SYSTEM, WITHOUT THE WRITTEN PERMISSION OF THE ENGINEER.

**EUBANKS ENGINEERING P.C.**  
**HUMPHREY**

102 Paisley St., Suite 200  
Greensboro, NC 27401

Phone 336.279.0663  
Fax 336.279.0053

FIRM LICENSE: C-2272

BUILDING SYSTEMS PLANS FOR:

**HARNETT SELF STORAGE**  
SPOUT SPRINGS, NC

JOB NO. 2278  
ORIGINAL ISSUE DATE 29JUL22  
DRAWN BY JMK  
CHECKED BY BEH  
SHEET NO.



# BUILDING 'B'

## NEW STORAGE FACILITY FOR

# HARNETT SELF STORAGE

## SPOUT SPRINGS, NC

THESE DRAWINGS ARE INSTRUMENTS OF SERVICE AND SHALL REMAIN THE PROPERTY OF THE ARCHITECT. THESE DRAWINGS ARE PROTECTED BY COPYRIGHT LAW AND MAY NOT BE REPRODUCED OR TRANSMITTED IN ANY FORM OR BY ANY MEANS, WITHOUT THE SPECIFIC WRITTEN CONSENT OF THE ARCHITECT.

© 2012 ERSKINE-SMITH ARCHITECTURE, P.L.L.C.

**ERSKINE-SMITH ARCHITECTURE, P.L.L.C.**  
 architecture research planning  
 Greensboro, N.C. 27407  
 Phone (336) 855-1286 Fax 855-5602

### APPENDIX "B" BUILDING CODE SUMMARY

Name of project: BLDG. 'B' NEW FACILITY FOR HARNETT SELF STORAGE  
 Address: \_\_\_\_\_ Zip Code: \_\_\_\_\_  
 Owner or Authorized Agent: VC SMITH Phone: 336-855-1286 E-mail: erskinesmith@bellsouth.net  
 Owned By:  City/County  Private  State  
 Code Enforcement Jurisdiction:  City - SARTFORD  County

CONTACT: Victor J. Smith  
 DESIGNER: ERSKINE-SMITH ARCHITECTURE, P.L.L.C. Victor J. Smith 6887 336-855-1286 erskinesmith@bellsouth.net  
 Architectural: \_\_\_\_\_ Name: \_\_\_\_\_ License No.: \_\_\_\_\_ Telephone No.: \_\_\_\_\_ E-MAIL ADDRESS: \_\_\_\_\_  
 Civil: \_\_\_\_\_  
 Electrical: \_\_\_\_\_  
 Fire Alarm: \_\_\_\_\_  
 Plumbing: \_\_\_\_\_  
 Mechanical: \_\_\_\_\_  
 Sprinkler/Standpipe: \_\_\_\_\_  
 Structural: \_\_\_\_\_  
 Retaining Walls >8' High: \_\_\_\_\_  
 Other: \_\_\_\_\_

2018 NC BUILDING CODE:  New Building  Addition  Renovation  
 1st Time Interior Completion  
 Shell/Core - Contact the local inspection jurisdiction for possible additional procedures and requirements  
 Phased Construction - Shell/Core - Contact the local inspection jurisdiction for possible additional procedures and requirements

2018 NC EXISTING BUILDING CODE, EXISTING:  Prescriptive  Repair  Chapter 14 Alterations  Level I  Level II  Level III  
 Historic Property  Change of Use

CONSTRUCTION (date): \_\_\_\_\_ ORIGINAL OCCUPANCY (Ch. 3): \_\_\_\_\_  
 RENOVATED (date): \_\_\_\_\_ PROPOSED OCCUPANCY (Ch. 3): \_\_\_\_\_  
 RISK CATEGORY (Table 1604.3):  I  II  III  IV  V

BASIC BUILDING DATA  
 Construction Type:  I-A  I-B  II-A  II-B  III-A  III-B  IV  V-A  V-B  
 Sprinklers:  No  Partial  Yes  NFPA 13  NFPA 13R  NFPA 13D  
 Standpipes:  No  Yes  Class:  I  II  III  Wet  Dry  
 Fire District:  No  Yes Flood Hazard Area:  No  Yes  
 Special Inspections Required:  No  YES  YES  YES  YES  YES  YES  YES  
 Manual Fire Alarm System with Notification:  No  Yes

FLOOR	EXISTING (SQ FT)	NEW (SQ FT)	SUB-TOTAL
4th Floor			
3rd Floor			
2nd Floor			
Mezzanine			
1st Floor		8,100 sf	
Basement			
TOTAL		8,100 sf	

Primary Occupancy Classification(s):  
 Assembly  A-1  A-2  A-3  A-4  A-5  
 Business  B-1  B-2  B-3  B-4  
 Educational  E-1  E-2  E-3  
 Factory  F-1  F-2  F-3  
 High Hazard  H-1  H-2  H-3  H-4  H-5  H-6  
 Institutional  I-1  I-2  I-3  
 Mercantile  M-1  M-2  M-3  M-4  
 Residential  R-1  R-2  R-3  R-4  
 Storage:  S-1  S-2  S-3  S-4  
 Utility and Miscellaneous  U-1  U-2  U-3  U-4

Accessory Occupancy Classification(s): \_\_\_\_\_  
 Special Uses (Chapter 4 - List Code Sections): \_\_\_\_\_  
 Special Provisions (Chapter 5 - List Code Sections): \_\_\_\_\_  
 Mixed Occupancy:  No  Yes Separation: \_\_\_\_\_ Hr. Exception: \_\_\_\_\_  
 Non-separated use (508.3)  
 The required type of construction for the building shall be determined by applying the height and area limitations for each of the applicable occupancies to the entire building. The most restrictive type of construction so determined shall apply to the entire building.  
 Separated Mixed Occupancy (508.4) - See below for area calculations.  
 For each story, the area of the occupancy shall be such that the sum of the ratios of the actual floor area of each use divided by allowable floor area for each use shall not exceed 1.  

$$\frac{\text{Actual Area of Occupancy A}}{\text{Allowable Area of Occupancy A}} + \frac{\text{Actual Area of Occupancy E}}{\text{Allowable Area of Occupancy E}} \leq 1$$

STORY NO.	DESCRIPTION AND USE	(A) BLDG AREA PER STORY (ACTUAL)	(B) TABLE 506.2 AREA	(C) AREA PER FRONTAGE INCREASE (1.4)	(D) ALLOWABLE AREA PER STORY (QUALIFIED 1)

- (1) Frontage area increases from Section 506.2 are computed as:  
 a. Perimeter which fronts a public way or open space having 20 feet minimum width = \_\_\_\_\_ (F)  
 b. Total Building Perimeter = \_\_\_\_\_ (P)  
 c. Ratio (F/P) = \_\_\_\_\_ (F/P)  
 d. W = Minimum width of public way = \_\_\_\_\_ (W)  
 e. Percent of frontage increase =  $1 + 100(F/P - 0.25) \times W/30 = \%$
- (2) Unlimited area applicable under conditions of Section 507  
 (3) Maximum Building Area = total number of stories in the building x D (506.2)  
 (4) The maximum area of open parking garages must comply with 406.5.4. The maximum area of air traffic control towers must comply with 403.3.  
 (5) Frontage increase is based on the unspinklered area value in Table 506.2

ALLOWABLE HEIGHT	Allowable		Code Reference
	55 FT.	12'	
Building Height in Feet (Table 504.3)	55 FT.	12'	
Building Height in Stories (Table 504.4)	2	1	

Provide code reference if the "shown on Plans" quantity is not based on Table 504.3 or 504.4.

NS = BUILDING NOT EQUIPPED THROUGHOUT WITH AN AUTOMATIC SPRINKLER SYSTEM

BUILDING ELEMENT	FIRE SEPARATION DISTANCE (FEET)	RATING	DETAIL AND SHEET #	DESIGN FOR RATED ASSEMBLY	DESIGN FOR RATED PENETRATION	DESIGN FOR RATED JOINTS
Structural Framing, including columns, girders, trusses	0					
Bearing walls						
Exterior						
NORTHWEST	6'-6"	0				
NORTHEAST	6'-6"	0				
SOUTHWEST WALL (ASSUMED PROPERTY LINE)	15'	0				
SOUTHWEST WALL	3'-4"	0				
Interior						
Nonbearing walls and partitions						
Exterior walls						
North	N/A	0				
East	N/A	0				
West	N/A	0				
South	N/A	0				
Interior walls & partitions						
Floor construction including supporting beams and joists	0					
Floor Ceiling Assembly	0					
Columns Supporting Roof	0					
Roof construction including supporting beams and joists	0					
Floor Ceiling Assembly	0					
Columns Supporting Roof	N/A					
Shells Enclosures - Exit	N/A					
Shells Enclosures - Others	N/A					
Corridor Separation	N/A					
Occupancy/Fire Barrier Separation	N/A					
PartyFire Wall Separation	N/A					
Smoke Barrier Separation	N/A					
Tenant / Dwelling Unit/ Sleeping Unit Separation	N/A					
Incidental Use Separation	N/A					

Fire Separation Distance (feet) / Non Property Line	Degree of Opening Protection (Table 105.8)	Allowable Area	Actual Shown on Plan (%)
NORTH 35'	UNPROTECTED, NONSPRINKLERED	NO LIMIT	0
WEST ASSUMED PROPERTY LINE	UNPROTECTED, NONSPRINKLERED	NO LIMIT PER TABLE 705.8.1 ex. 2	64%
SOUTH 17.5'	UNPROTECTED, NONSPRINKLERED	NO LIMIT PER TABLE 705.8.1 ex. 2	58%
EAST ASSUMED PROPERTY LINE	UNPROTECTED, NONSPRINKLERED	NO LIMIT PER TABLE 705.8.1 ex. 2	54%

LIFE SAFETY PLAN REQUIREMENTS  
 Life Safety Plan Sheet - COVER SHEET  
 Fire and/or smoke rated wall locations (Chapter 7)  
 Assumed and real property line locations (if not on site plan)  
 Exterior wall opening area with respect to distance to assumed property lines (105.8)  
 Occupancy use for each area as it relates to occupancy load calculation (Table 1004.12)  
 Occupant loads for each area  
 Exit access travel distance (107)  
 Common path of travel distance (Table 1006.21 & 1006.32(1))  
 Clear exit width for each exit door  
 Maximum calculated occupant load capacity each exit door can accommodate based on egress width (1009.3)  
 Actual occupant load for each exit door  
 A separate schematic plan indicating where fire rated floor ceiling and/or roof structure is provided for purposes of occupancy separation  
 Location of doors with panic hardware (1010.10)  
 Location of doors with delayed egress locks and the amount of delay (1010.11)  
 Location of doors with electromagnetic egress locks (1010.13)  
 Location for doors equipped with hold-open devices  
 Location of emergency escape windows (1020)  
 The square footage of each fire area (1021)  
 The square footage of each smoke compartment for Occupancy Classification 1-2 (407B)  
 Note any code exceptions or table notes that may have been utilized regarding the items above

TOTAL UNITS	ACCESSIBLE UNITS REQUIRED	ACCESSIBLE UNITS PROVIDED	TYPE 'A' UNITS REQUIRED	TYPE 'A' UNITS PROVIDED	TYPE 'B' UNITS REQUIRED	TYPE 'B' UNITS PROVIDED	TOTAL ACCESSIBLE UNITS PROVIDED

LOT OR PARKING AREAS	TOTAL # OF PARKING SPACES REQUIRED	# OF ACCESSIBLE SPACES PROVIDED	TOTAL NO. ACCESSIBLE

USE	WATER CLOSETS		URINALS		LAVATORIES		SHOWERS		DRINKING FOUNTAINS	
	MALE	FEMALE	UNSEX	UNSEX	MALE	FEMALE	UNSEX	TUBS	REGULAR	ACCESSIBLE
OUTSIDE EXISTING										
INSIDE EXISTING										
NEW REQUIRED										
TOTAL PROVIDED										

SPECIAL APPROVALS (Table 2902.1)  
 Special approval: (Local Jurisdiction, Department of Insurance, OIG, DPI, DPH, ICC, etc., describe below)

ENERGY REQUIREMENTS  
 The following data shall be considered minimum and any special attributes required to meet the energy code shall also be provided. Each Designer shall furnish the required portions of the project information for the plan data sheet. If performance method, state the annual energy cost standard reference design vs annual energy cost for the proposed design.

Climate Zone  3  4  5  
 Method of Compliance  
 Prescriptive (Energy Code)  
 Performance (Energy Code)  
 Prescriptive (ASHRAE 90.1)  
 Performance (ASHRAE 90.1)

THERMAL ENVELOPE  
 Roof/Ceiling Assembly (each assembly)  
 Description of assembly: \_\_\_\_\_  
 U-Value of total assembly: \_\_\_\_\_  
 R-Value of insulation: \_\_\_\_\_  
 Skylights in each assembly: \_\_\_\_\_  
 U-Value of skylight: \_\_\_\_\_  
 total square footage of skylights in each assembly: \_\_\_\_\_

Exterior Walls (each assembly)  
 Description of assembly: \_\_\_\_\_  
 U-Value of total assembly: \_\_\_\_\_  
 R-Value of insulation: \_\_\_\_\_  
 Openings in each assembly (e.g. doors with glazing): \_\_\_\_\_  
 Description of assembly: \_\_\_\_\_  
 U-Value of total assembly: \_\_\_\_\_  
 Door R-Values: \_\_\_\_\_

Floors over unconditioned space (each assembly)  
 Description of assembly: \_\_\_\_\_  
 U-Value of total assembly: \_\_\_\_\_  
 R-Value of insulation: \_\_\_\_\_

Floors slab on grade  
 Description of assembly: \_\_\_\_\_  
 U-Value of total assembly: \_\_\_\_\_  
 R-Value of insulation: \_\_\_\_\_  
 Horizontal/vertical requirement: \_\_\_\_\_  
 slab rested: \_\_\_\_\_

STRUCTURAL DESIGN  
 DESIGN LOADS:  
 Importance Factors: Snow (Is) \_\_\_\_\_  
 Seismic (Is) \_\_\_\_\_

Live Loads: Roof \_\_\_\_\_ psf  
 Mezzanine \_\_\_\_\_ psf  
 Floor \_\_\_\_\_ psf  
 Ground Snow Load: \_\_\_\_\_ psf  
 Wind Loads: Ultimate Wind Speed (ASCE-7) \_\_\_\_\_  
 Exposure Category \_\_\_\_\_

SEISMIC DESIGN CATEGORY  A  B  C  D  
 Provide the following Seismic Design Parameters:  
 Risk Category (Table 1604.5)  I  II  III  IV  
 Spectral Response Acceleration Coefficient (ASCE 7-10)  A  B  C  D  E  F  
 Site Classification (ASCE 7-10)  I  II  III  IV  
 Basic structural analysis (check one):  
 Analytical (check one)  Dual w/ Special Moment Frame  Dual w/ Intermediate RC or Special Steel Moment Frame  
 Analytical Procedure  Simplified  Equivalent Lateral Force  Dynamic  
 Architectural, Mechanical, components anchored  Yes  No

LATERAL DESIGN CONTROL:  Earthquake (Lower Level - Bldg. A & B)  Wind (Upper Level - Bldg. A & B and C & D)

SOIL BEARING CAPACITIES:  
 Field Test (provide copy of test report) \_\_\_\_\_ psf  
 File size, type, and capacity \_\_\_\_\_

SIZE	MARK	BUILDING TYPE				TOTAL	ACCESSIBLE UNITS
		A	B	C	J		
5'x5'	A	4	-	-	-	66	BLDG. A
5'x10'	B	13	6	8	-	81	
10'x10'	G	105	-	-	-	81	BLDG. A
10'x15'	H	24	52	-	-	183	
10'x20'	I	16	-	60	-	88	BLDG. J
12'x30'	K	-	-	-	26	44	
12'x30'	L	-	-	-	30	30	
TOTAL		162	58	68	44	332	

CODE REQUIREMENTS	PERCENTAGE	# OF UNITS	# OF ADA UNITS REQ.
5% OF THE FIRST 200 UNITS	5%	200	10
2% OF REMAINING UNITS	2%	132	2.64
TOTAL		332	3

NOTE: ALL ACCESSIBLE STORAGE UNIT DOORS SHALL HAVE A MAX. 5 LB. FULL

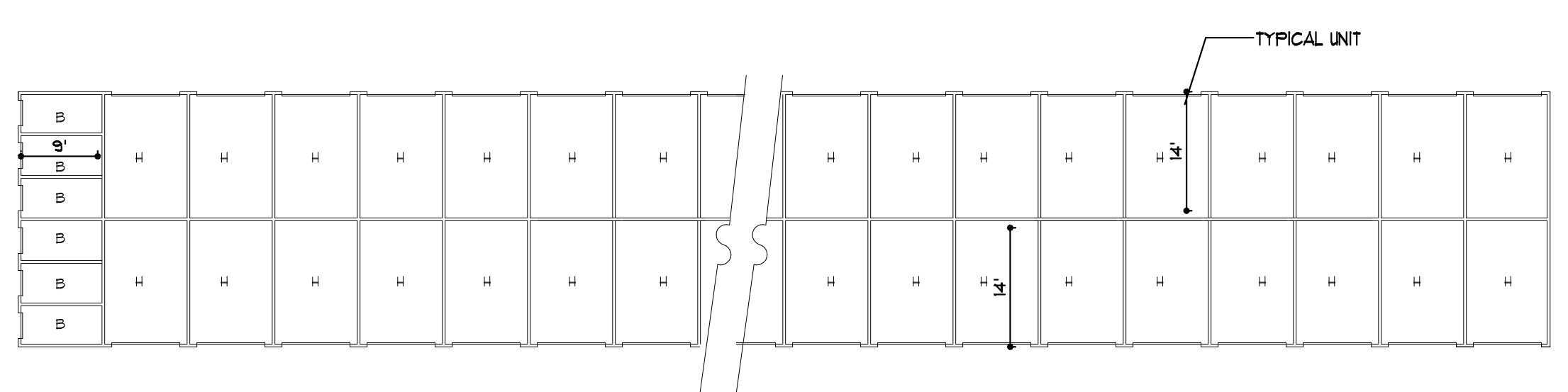

LIFE SAFETY & OCCUPANCY PLAN  
 1/16" = 1'-0"  
 OCCUPANCY STORAGE 8,100 SF / 500 = 162

**BUILDING 2/B**



NEW STORAGE FACILITY FOR BLDG. 'B'

# HARNETT SELF STORAGE

SPOUT SPRINGS, NC

REVISIONS BY \_\_\_\_\_

DRAWN BY: VJS  
 CHECKED BY: RHE  
 DATE: 07-29-2022  
 SCALE: 1/16" = 1'-0"  
 FILE: \_\_\_\_\_  
 SHEET NUMBER: \_\_\_\_\_  
**COVER BLDG. B**

THESE DRAWINGS ARE INSTRUMENTS OF SERVICE AND SHALL REMAIN THE PROPERTY OF THE ARCHITECT. THESE DRAWINGS ARE PROTECTED UNDER COPYRIGHT LAWS AND MAY NOT BE REPRODUCED IN PART OR IN WHOLE WITHOUT THE SPECIFIC WRITTEN CONSENT OF THE ARCHITECT.  
 © 2016 ERSKINE-SMITH ARCHITECTURE, PLLC

**ERSKINE-SMITH ARCHITECTURE**  
 architecture research planning  
 3406-A West Wendover Avenue  
 Greensboro, N.C. 27407  
 Phone (336) 855-1286 Fax 855-5602

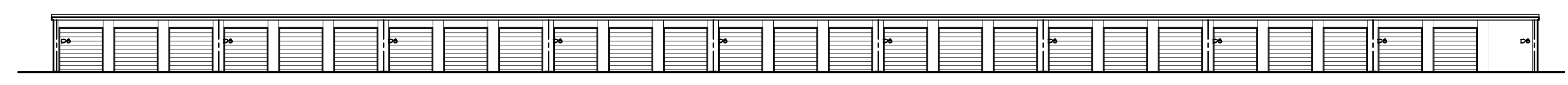

**WEST ELEVATION**  
 1/16" = 1'-0"

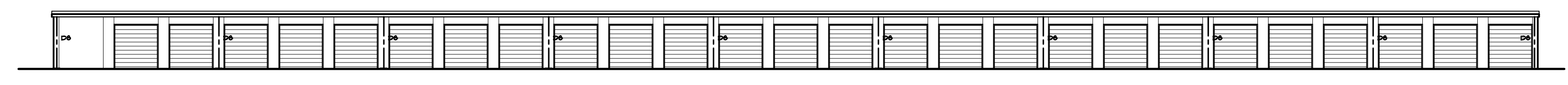

**EAST ELEVATION**  
 1/16" = 1'-0"

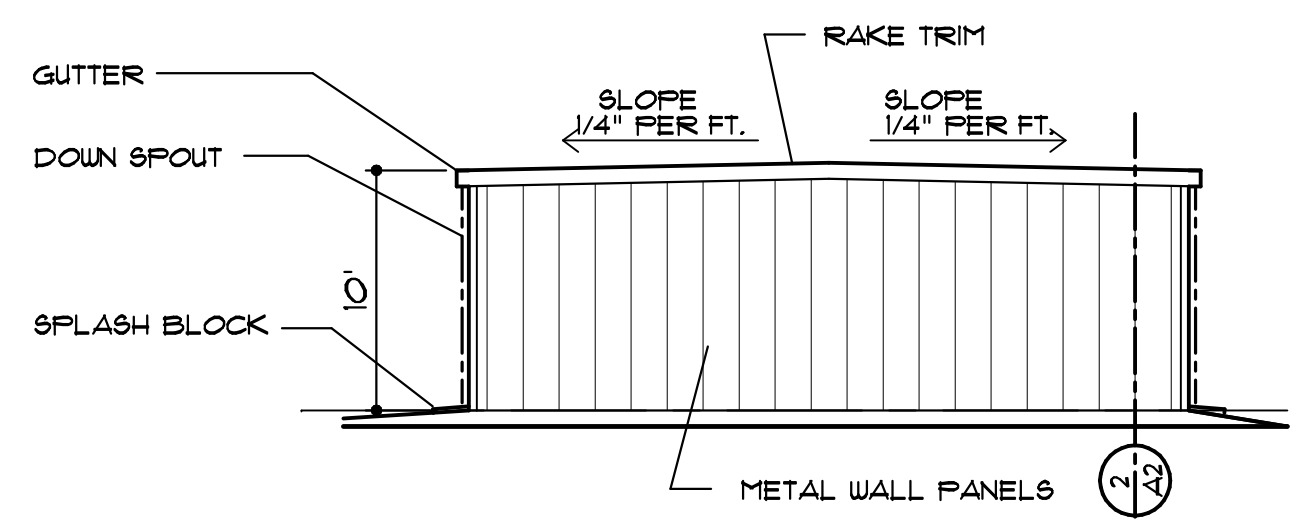

**NORTH ELEVATION**  
 1/8" = 1'-0"

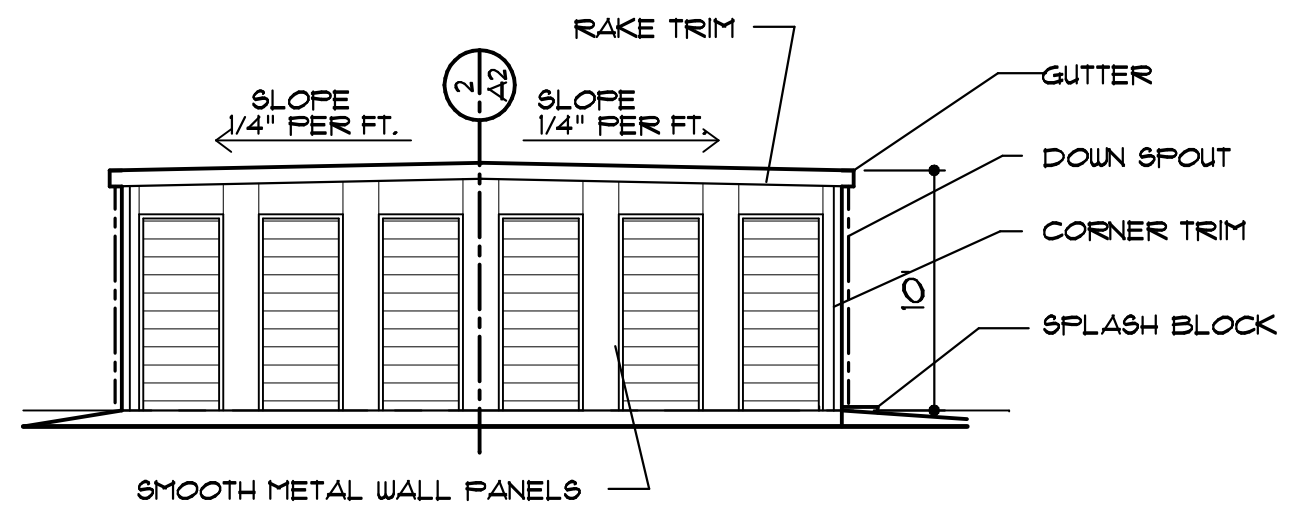

**SOUTH ELEVATION**  
 1/8" = 1'-0"

ALL RAIN LEADER TO HAVE SPLASH BLOCKS

**DOWN SPOUTS & GUTTERS**  
 ROOF AREA = 13,500 SF  
 GUTTER LENGTH = 450' LF  
 GUTTER SIZE = 5" w x 4" d  
 # DOWN SPOUT (3" x 4") = 16  
 AREA PER DOWN SPOUT = 844 sf



**PARTIAL WEST ELEVATION**  
 1/8" = 1'-0"

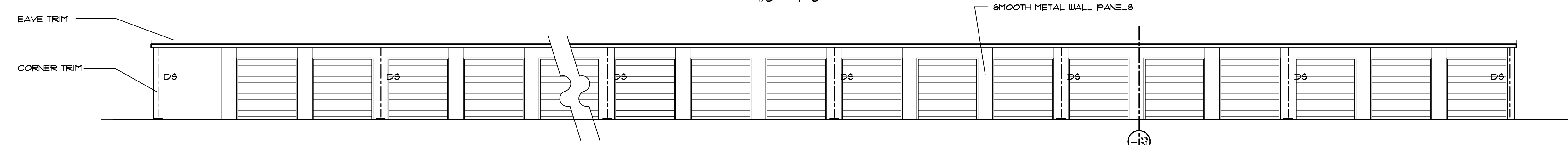

**PARTIAL EAST ELEVATION**  
 1/8" = 1'-0"

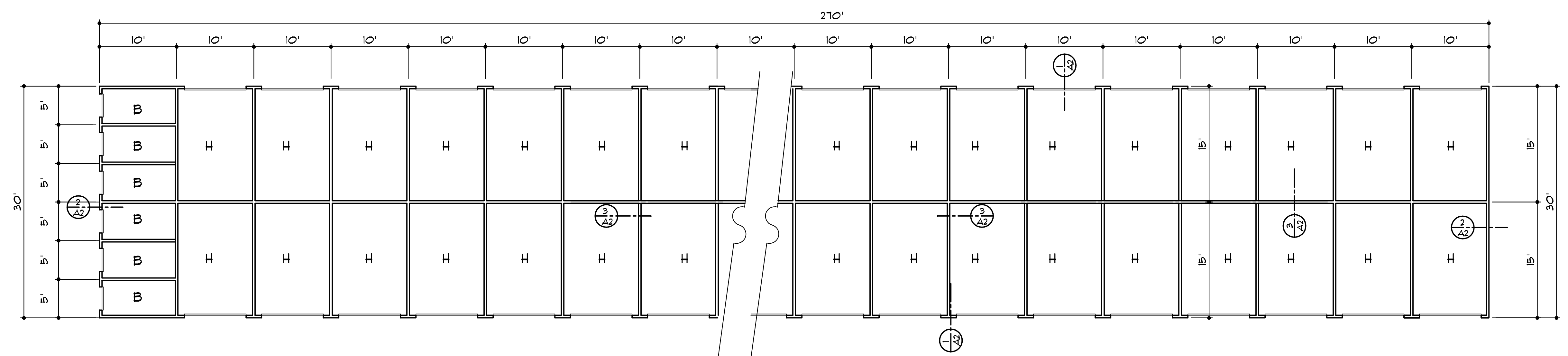

**FLOOR PLAN**  
 1/8" = 1'-0"

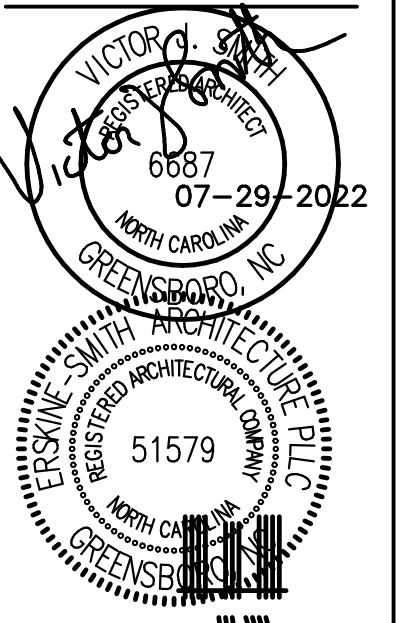

**NEW STORAGE FACILITY FOR HARNETT SELF STORAGE**  
 SPOUT SPRINGS, NC

**BLDG. B 8,100 SF**

REVISIONS	BY

DRAWN BY : VJS  
 CHECKED BY : VJS  
 DATE : 07-29-2022  
 SCALE : AS SHOWN  
 FILE :  
 SHEET NUMBER :

**A-1**



THESE DRAWINGS ARE INSTRUMENTS OF SERVICE AND SHALL REMAIN THE PROPERTY OF THE ARCHITECT. THESE DRAWINGS ARE PROTECTED UNDER COPYRIGHT LAWS AND ANY REUSE, REPRODUCTION IN PART OR IN WHOLE WITHOUT THE SPECIFIC WRITTEN CONSENT OF THE ARCHITECT.  
 © 2014 ERSKINE-SMITH Architecture, P.L.L.C.

**ERSKINE-SMITH ARCHITECTURE, P.L.L.C.**  
 architecture research planning  
 3406-A West Wendover Avenue  
 Greensboro, N.C. 27407  
 Phone (336) 855-1286 Fax 855-5602



**NEW STORAGE FACILITY FOR BLDG. 'B'**  
**HARNETT SELF STORAGE**  
 SPOUT SPRINGS, NC

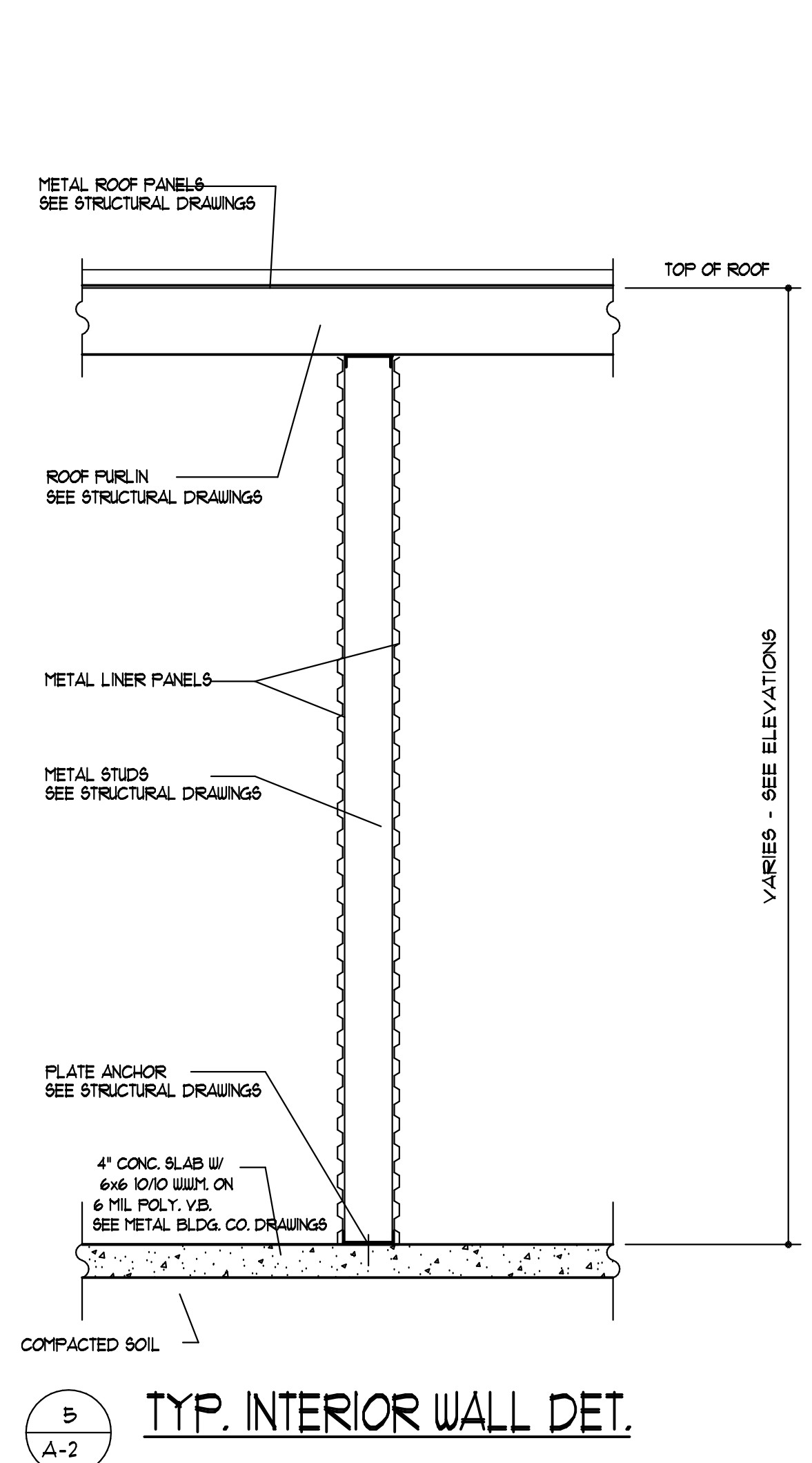

5  
A-2 TYP. INTERIOR WALL DET.

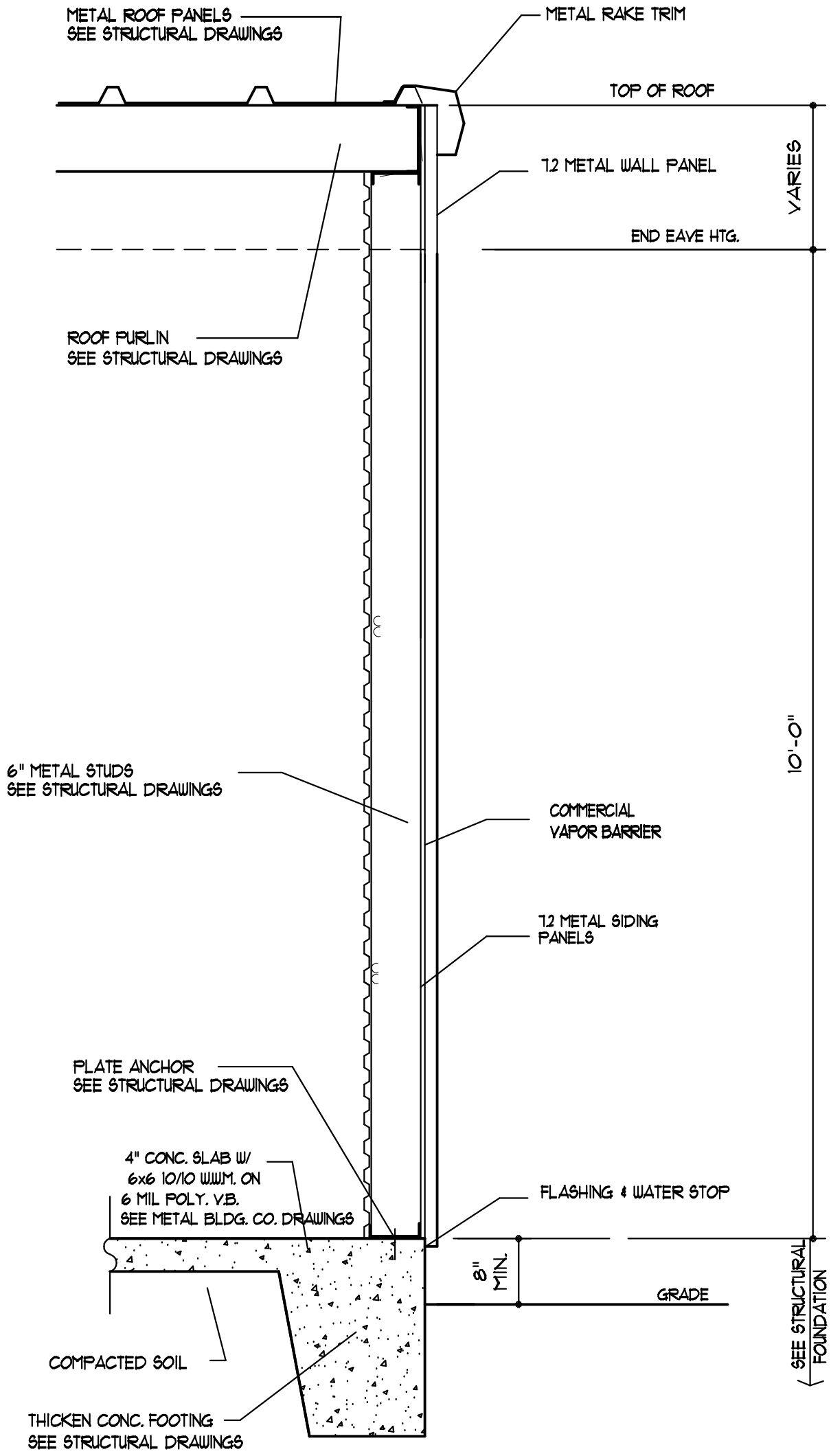

2  
A-2 TYP. EXTERIOR END WALL DET.

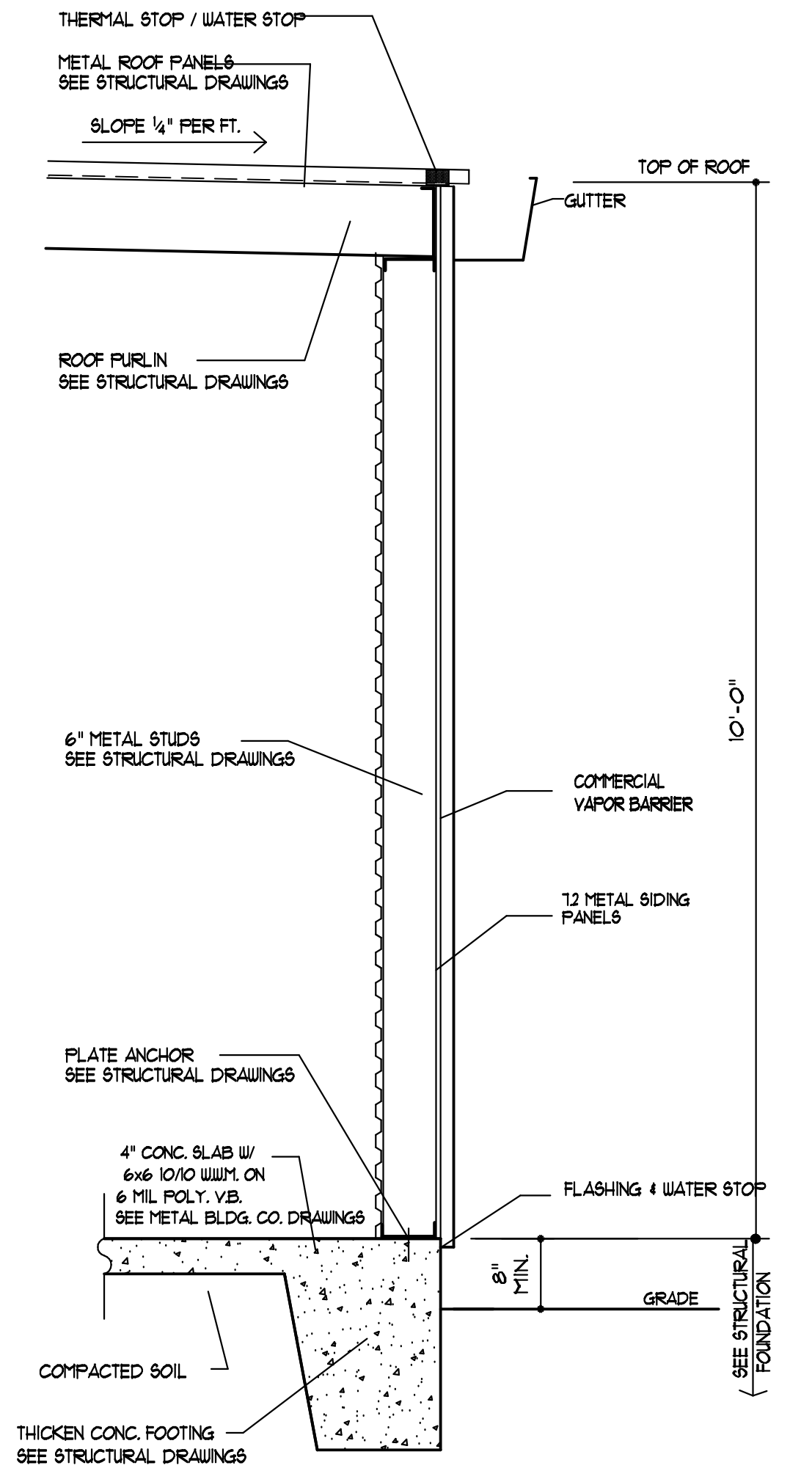

1  
A-2 TYP. EXTERIOR WALL DET.

NOTE: DO NOT SCALE DRAWINGS  
 PDF & PRINTING CHANGES SCALE

REVISIONS	BY

DRAWN BY : VJS  
 CHECKED BY : VJS  
 DATE : 07-29-2022  
 SCALE : 3/4" = 1'-0"  
 FILE :

SHEET NUMBER :  
**A-2**  
 BLDG. 'B'

# BUILDING 'C'

## NEW STORAGE FACILITY FOR

# HARNETT SELF STORAGE

## SPOUT SPRINGS, NC

THESE DRAWINGS ARE INSTRUMENTS OF SERVICE AND SHALL REMAIN THE PROPERTY OF THE ARCHITECT. THESE DRAWINGS ARE PROTECTED BY COPYRIGHT LAW AND MAY NOT BE REPRODUCED OR TRANSMITTED IN ANY FORM OR BY ANY MEANS, WITHOUT THE SPECIFIC WRITTEN CONSENT OF THE ARCHITECT.

© 2012 ERSKINE-SMITH ARCHITECTURE, P.L.L.C.

**ERSKINE-SMITH ARCHITECTURE, P.L.L.C.**  
 architecture research planning  
 3406-A West Wendover Avenue  
 Greensboro, N.C. 27407  
 Phone (336) 855-1286 Fax 855-5602

### APPENDIX "B" BUILDING CODE SUMMARY

Name of project: BLDG. 'C' NEW FACILITY FOR HARNETT SELF STORAGE  
 Address: \_\_\_\_\_ Zip Code: \_\_\_\_\_  
 Owner or Authorized Agent: VC SMITH Phone: 336-855-1286 E-mail: erskinesmith@bellsouth.net  
 Owned By:  City/County  Private  State  
 Code Enforcement Jurisdiction:  City  SAITFORD  County

CONTACT: Victor J. Smith  
 DESIGNER: FIRM NAME LICENSE NO. TELEPHONE NO. E-MAIL ADDRESS  
 Architectural: ERSKINE-SMITH ARCHITECTURE, P.L.L.C. Victor J. Smith 6887 336-855-1286 erskinesmith@bellsouth.net  
 Civil: \_\_\_\_\_  
 Electrical: \_\_\_\_\_  
 Fire Alarm: \_\_\_\_\_  
 Plumbing: \_\_\_\_\_  
 Mechanical: \_\_\_\_\_  
 Sprinkler/Standpipe: \_\_\_\_\_  
 Structural: \_\_\_\_\_  
 Retaining Walls >8' High: \_\_\_\_\_  
 Other: \_\_\_\_\_

2018 NC BUILDING CODE:  New Building  Addition  Renovation  
 1st Time Interior Completion  
 Shell/Core - Contact the local inspection jurisdiction for possible additional procedures and requirements  
 Phased Construction - Shell/Core - Contact the local inspection jurisdiction for possible additional procedures and requirements

2018 NC EXISTING BUILDING CODE, EXISTING:  Prescriptive  Repair  Chapter 14 Alterations  
 Level I  Level II  Level III  
 Historic Property  Change of Use

CONSTRUCTION (date): \_\_\_\_\_ ORIGINAL OCCUPANCY (Ch. 3): \_\_\_\_\_  
 RENOVATED (date): \_\_\_\_\_ PROPOSED OCCUPANCY (Ch. 3): STORAGE  
 RISK CATEGORY (Table 1604.3):  I  II  III  IV  
 Proposed  I  II  III  IV

BASIC BUILDING DATA  
 Construction Type:  I-A  I-B  II-A  II-B  III-A  III-B  IV  V-A  V-B  
 Sprinklers:  No  Partial  Yes  NFPA 13  NFPA 13R  NFPA 13D  
 Standpipes:  No  Yes Class:  I  II  III  Wet  Dry  
 Fire District:  No  Yes Flood Hazard Area:  No  Yes  
 Special Inspections Required:  No  YES  YES  YES  YES  YES  YES  
 Manual Fire Alarm System with Notification:  No  Yes

FLOOR	EXISTING (SQ FT)	NEW (SQ FT)	SUB-TOTAL
4th Floor			
3rd Floor			
2nd Floor			
Mezzanine	AREA 'A'	AREA 'B'	
1st Floor	9,200 sf	3,200 sf	
Basement			
TOTAL	9,200 sf	12,400 sf	12,400 sf TOTAL

Primary Occupancy Classification(s):  A-1  A-2  A-3  A-4  A-5  
 Assembly  Business  Educational  Factory  High Hazard Institutional  Mercantile Residential  Storage  Utility and Miscellaneous  
 F-1 Moderate  F-2 Low  H-1 Delicate  H-2 Deletable  H-3 Combust  H-4 Health  H-5 HPM  
 I-1 Condition  I-2 Condition  I-3 Condition  I-4 Condition  I-1  I-2  I-3  I-4  
 R-1  R-2  R-3  R-4  
 S-1 Moderate  S-2 Low  High Piled  Open  Enclosed  Repair Garage

Accessory Occupancy Classification(s): NA  
 Special Uses (Chapter 4 - List Code Sections): NA  
 Special Provisions (Chapter 5 - List Code Sections): NA  
 Mixed Occupancy:  No  Yes Separation: \_\_\_\_\_ Hr. Exception: \_\_\_\_\_  
 Non-separated Use (508.3)  
 The required type of construction for the building shall be determined by applying the height and area limitations for each of the applicable occupancies to the entire building. The most restrictive type of construction so determined shall apply to the entire building.  
 Separated Mixed Occupancy (508.4) - See below for area calculations. For each story, the area of the occupancy shall be such that the sum of the ratios of the actual floor area of each use divided by allowable floor area for each use shall not exceed 1.  
 Actual Area of Occupancy A + Actual Area of Occupancy E ≤ 1  
 Allowable Area of Occupancy A + Allowable Area of Occupancy E ≤ 100

STORY NO.	DESCRIPTION AND USE	(A) BLDG AREA PER STORY (ACTUAL)	(B) TABLE 506.2 AREA	(C) AREA FOR INCREASE 1.4	(D) ALLOWABLE AREA PER STORY (QUALIFIED 1.4)

(1) Frontage area increases from Section 506.2 are computed as:  
 a. Perimeter which fronts a public way or open space having 20 feet minimum width = \_\_\_\_\_ (F)  
 b. Total Building Perimeter = \_\_\_\_\_ (P)  
 c. Ratio (F/P) = \_\_\_\_\_ (F/P)  
 d. W = Minimum width of public way = \_\_\_\_\_ (W)  
 e. Percent of frontage increase =  $(\frac{F}{P} - 0.25) \times W \times 30 = \dots \%$   
 (2) Unlimited area applicable under conditions of Section 507  
 (3) Maximum Building Area = total number of stories in the building x D (506.2)  
 (4) The maximum area of open parking garages must comply with 406.5.4. The maximum area of air traffic control towers must comply with 403.3.  
 (5) Frontage increase is based on the unspinklered area value in Table 506.2

ALLOWABLE HEIGHT	Allowable		Code Reference
	Building Height in Feet (Table 504.3)	Building Height in Stories (Table 504.4)	
	55 FT.	2	

Provide code reference if the "shown on Plans" quantity is not based on Table 504.3 or 504.4.

NS = BUILDING NOT EQUIPPED THROUGHOUT WITH AN AUTOMATIC SPRINKLER SYSTEM

BUILDING ELEMENT	FIRE SEPARATION DISTANCE (FEET)	RATING	DETAIL AND SHEET #	DESIGN FOR RATED ASSEMBLY	DESIGN FOR RATED PENETRATION	DESIGN FOR RATED JOINTS
Structural Framing, including columns, girders, trusses	0					
Bearing walls						
Exterior						
NORTHWEST	6'-6"	0				
NORTHEAST	6'-6"	0				
SOUTHWEST WALL (ASSUMED PROPERTY LINE)	15'	0				
SOUTHWEST WALL	3'-4"	0				
Interior						
Nonbearing walls and partitions						
Exterior walls						
North	N/A	0				
East	N/A	0				
West	N/A	0				
South	N/A	0				
Interior walls & partitions						
Floor construction including supporting beams and joists	0					
Floor Ceiling Assembly	0					
Columns Supporting Roof	0					
Roof construction including supporting beams and joists	0					
Floor Ceiling Assembly	0					
Columns Supporting Roof	N/A					
Shells Enclosures - Exit	N/A					
Shells Enclosures - Other	N/A					
Corridor Separation	N/A					
Occupancy/Fire Barrier Separation	N/A					
PartyFire Wall Separation	2-hr	2-hr	U-419	3/A-3		
Smoke Barrier Separation	N/A					
Tenant / Dwelling Unit/ Sleeping Unit Separation	N/A					
Incidental Use Separation	N/A					

Fire Separation Distance (feet) / Non Property Line	Degree of Opening Protection (Table 705.8)	Allowable Area	Actual Shown on Plan (%)
NORTH 35'	UNPROTECTED, NONSPRINKLERED	NO LIMIT	0
WEST ASSUMED PROPERTY LINE 14.5'	UNPROTECTED, NONSPRINKLERED	NO LIMIT PER TABLE 705.8.1 ex. 2	64%
SOUTH ASSUMED PROPERTY LINE 17.5'	UNPROTECTED, NONSPRINKLERED	NO LIMIT PER TABLE 705.8.1 ex. 2	58%
EAST ASSUMED PROPERTY LINE 14.5'	UNPROTECTED, NONSPRINKLERED	NO LIMIT PER TABLE 705.8.1 ex. 2	64%

Life Safety Plan Sheet \* COVER SHEET  
 Fire and/or smoke rated wall locations (Chapter 7)  
 Assumed and real property line locations (if not on site plan)  
 Exterior wall opening areas with respect to distance to assumed property lines (705.8)  
 Occupancy use for each area as it relates to occupancy load calculation (Table 1004.12)  
 Occupant loads for each area  
 Exit access travel distance (1017)  
 Common path of travel distance (Table 1006.2.1 & 1006.3.2(1))  
 Dead end lengths (1020.4)  
 Clear exit width for each exit door  
 Maximum calculated occupant load capacity each exit door can accommodate based on egress width (1009.3)  
 Actual occupant load for each exit door  
 A separate schematic plan indicating where fire rated floor ceiling and/or roof structure is provided for purposes of occupancy separation  
 Location of doors with panic hardware (1010.1.0)  
 Location of doors with delayed egress locks and the amount of delay (1010.1.1.1)  
 Location of doors with electromagnetic egress locks (1010.1.3.3)  
 Location for doors equipped with hold-open devices  
 Location of emergency escape windows (1020)  
 The square footage of each fire area (C22)  
 The square footage of each smoke compartment for Occupancy Classification 1-2 (401B)  
 Note any code exceptions or table notes that may have been utilized regarding the items above

TOTAL UNITS	ACCESSIBLE UNITS REQUIRED	ACCESSIBLE UNITS PROVIDED	TYPE 'A' UNITS REQUIRED	TYPE 'A' UNITS PROVIDED	TYPE 'B' UNITS REQUIRED	TYPE 'B' UNITS PROVIDED	TOTAL ACCESSIBLE UNITS PROVIDED

LOT OR PARKING AREAS	TOTAL # OF PARKING SPACES REQUIRED	# OF ACCESSIBLE SPACES PROVIDED		TOTAL NO. ACCESSIBLE UNITS PROVIDED
		REGULAR	VAN SPACES WITH 8' BY ACCESSIBLE BY ACCESSIBLE	

USE	WATER CLOSETS		URINALS		LAVATORIES		SHOWERS		DRINKING FOUNTAINS	
	MALE	FEMALE	UNSEX	UNSEX	MALE	FEMALE	UNSEX	TUBS	REGULAR	ACCESSIBLE
OUTSIDE EXISTING										
INSIDE EXISTING										
NEW REQUIRED										
TOTAL PROVIDED										

SPECIAL APPROVALS (Table 2902.1)  
 Special approval: (Local Jurisdiction, Department of Insurance, O.C. DPI, DPH, ICC, etc., describe below)

ENERGY REQUIREMENTS:  
 The following data shall be considered minimum and any special attributes required to meet the energy code shall also be provided. Each Designer shall furnish the required portions of the project information for the plan data sheet. If performance method, state the annual energy cost standard reference design vs annual energy cost for the proposed design.

Climate Zone  3  4  5  
 Method of Compliance:  Prescriptive (Energy Code)  Performance (Energy Code)  Prescriptive (ASHRAE 90.1)  Performance (ASHRAE 90.1)

THERMAL ENVELOPE  
 Roof/Ceiling Assembly (each assembly):  
 Description of assembly: \_\_\_\_\_  
 U-Value of total assembly: \_\_\_\_\_  
 R-Value of total assembly: \_\_\_\_\_  
 Skylights in each assembly: \_\_\_\_\_  
 U-Value of skylight: \_\_\_\_\_  
 total square footage of skylights in each assembly: \_\_\_\_\_

Exterior Walls (each assembly):  
 Description of assembly: \_\_\_\_\_  
 U-Value of total assembly: \_\_\_\_\_  
 R-Value of total assembly: \_\_\_\_\_  
 Openings (glazing): \_\_\_\_\_  
 Description of assembly: \_\_\_\_\_  
 U-Value of total assembly: \_\_\_\_\_  
 Door R-Values: \_\_\_\_\_

Floors over unconditioned space (each assembly):  
 Description of assembly: \_\_\_\_\_  
 U-Value of total assembly: \_\_\_\_\_  
 R-Value of total assembly: \_\_\_\_\_

Floors slab on grade (each assembly):  
 Description of assembly: \_\_\_\_\_  
 U-Value of total assembly: \_\_\_\_\_  
 R-Value of total assembly: \_\_\_\_\_  
 Horizontal/vertical requirement: \_\_\_\_\_  
 slab rested: \_\_\_\_\_

STRUCTURAL DESIGN  
 DESIGN LOADS:  
 Importance Factors: Snow (Is) \_\_\_\_\_ Seismic (Ie) \_\_\_\_\_  
 Live Loads: Roof \_\_\_\_\_ psf  
 Mezzanine \_\_\_\_\_ psf  
 Floor \_\_\_\_\_ psf  
 Ground Snow Load: \_\_\_\_\_ psf  
 Wind Loads: Ultimate Wind Speed (ASCE-7) \_\_\_\_\_ Exposure Category \_\_\_\_\_

SEISMIC DESIGN CATEGORY:  A  B  C  D  
 Provide the following Seismic Design Parameters:  
 Risk Category (Table 1604.5):  I  II  III  IV  
 Spectral Response Acceleration Coefficient (S<sub>s</sub>):  A  B  C  D  E  F  
 Site Classification (Table 1601.4):  I  II  III  IV  V  VI  VII  
 Basic structural analysis (check one):  
 Dual w/ Special Moment Frame  Dual w/ Special Moment Frame (Upper Walls)  
 Dual w/ Intermediate R/C or Special Steel  Inverted Pendulum

ANALYSIS PROCEDURE:  Simplified  Equivalent Lateral Force  Dynamic  
 Architectural, Mechanical, components anchored:  Yes  No

LATERAL DESIGN CONTROL:  Earthquake (Lower Level - Bldg. A & B)  Wind (Upper Level - Bldg. A & B and C & D)

SOIL BEARING CAPACITIES:  
 Field Test (provide copy of test report): \_\_\_\_\_ psf  
 File size, type, and capacity: \_\_\_\_\_

SIZE	MARK	BUILDING TYPE				TOTAL	ACCESSIBLE UNITS
		A	B	C	J		
5'x5'	A	4	-	-	-	66	
5'x10'	B	13	6	8	-	81	BLDG. A
10'x10'	G	105	-	-	-	81	B
10'x15'	H	24	52	-	-	183	BLDG. A
10'x20'	I	16	-	60	-	88	B
10'x30'	K	-	-	-	26	44	BLDG. J
12'x30'	L	-	-	-	15	30	C
TOTAL		162	58	68	44	332	13

CODE REQUIREMENTS	PERCENTAGE	# OF UNITS	# OF ADA UNITS REQ.
5% OF THE FIRST 200 UNITS	5%	200	10
2% OF REMAINING UNITS	2%	132	2.64
TOTAL		332	3

NOTE: ALL ACCESSIBLE STORAGE UNIT DOORS SHALL HAVE A MAX. 5 LB. FULL

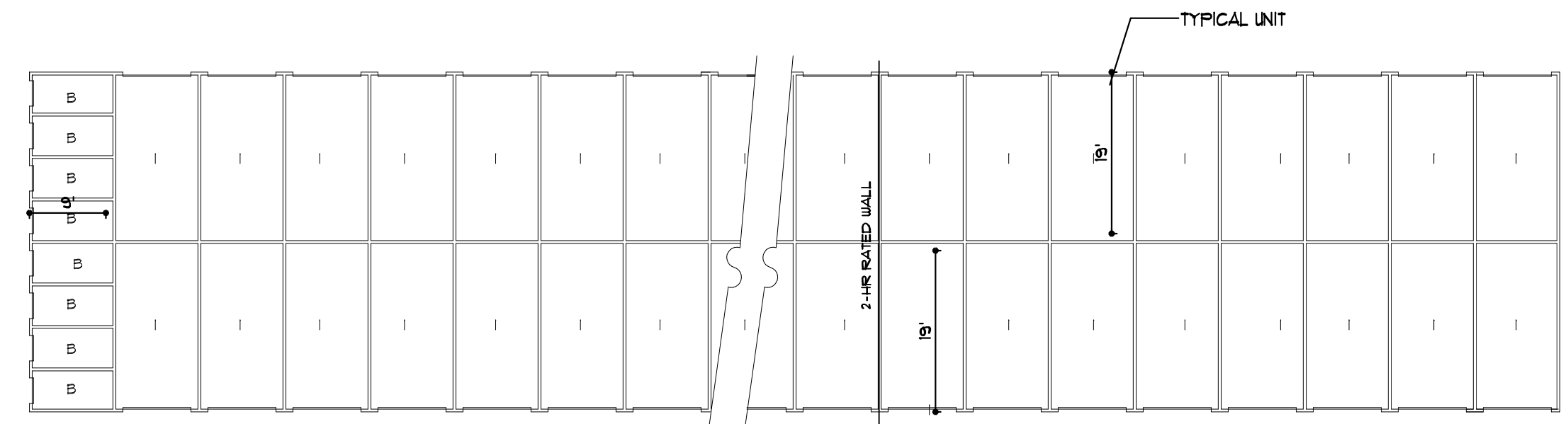

LIFE SAFETY & OCCUPANCY PLAN  
 1/16" = 1'-0"  
 OCCUPANCY STORAGE 12,400 SF / 500 = 25

**BUILDING 3/C**



NEW STORAGE FACILITY FOR BLDG. 'C'  
**HARNETT SELF STORAGE**  
 SPOUT SPRINGS, NC

REVISIONS BY \_\_\_\_\_  
 DRAWN BY: VJS  
 CHECKED BY: RHE  
 DATE: 07-29-2022  
 SCALE: 1/16" = 1'-0"  
 FILE:  
 SHEET NUMBER:  
**COVER BLDG. C**

THESE DRAWINGS ARE INSTRUMENTS OF SERVICE AND SHALL REMAIN THE PROPERTY OF THE ARCHITECT. THESE DRAWINGS ARE PROTECTED UNDER COPYRIGHT LAWS AND MAY NOT BE REPRODUCED IN PART OR IN WHOLE WITHOUT THE SPECIFIC WRITTEN CONSENT OF THE ARCHITECT.  
 © 2016 ERSKINE-SMITH ARCHITECTURE, PLLC

**ERSKINE-SMITH ARCHITECTURE**  
 architecture research planning  
 3406-A West Wendover Avenue  
 Greensboro, N.C. 27407  
 Phone (336) 855-1286 Fax 855-5602

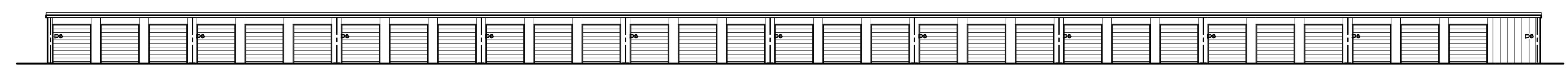

**WEST ELEVATION**  
 1/16" = 1'-0"



**EAST ELEVATION**  
 1/16" = 1'-0"

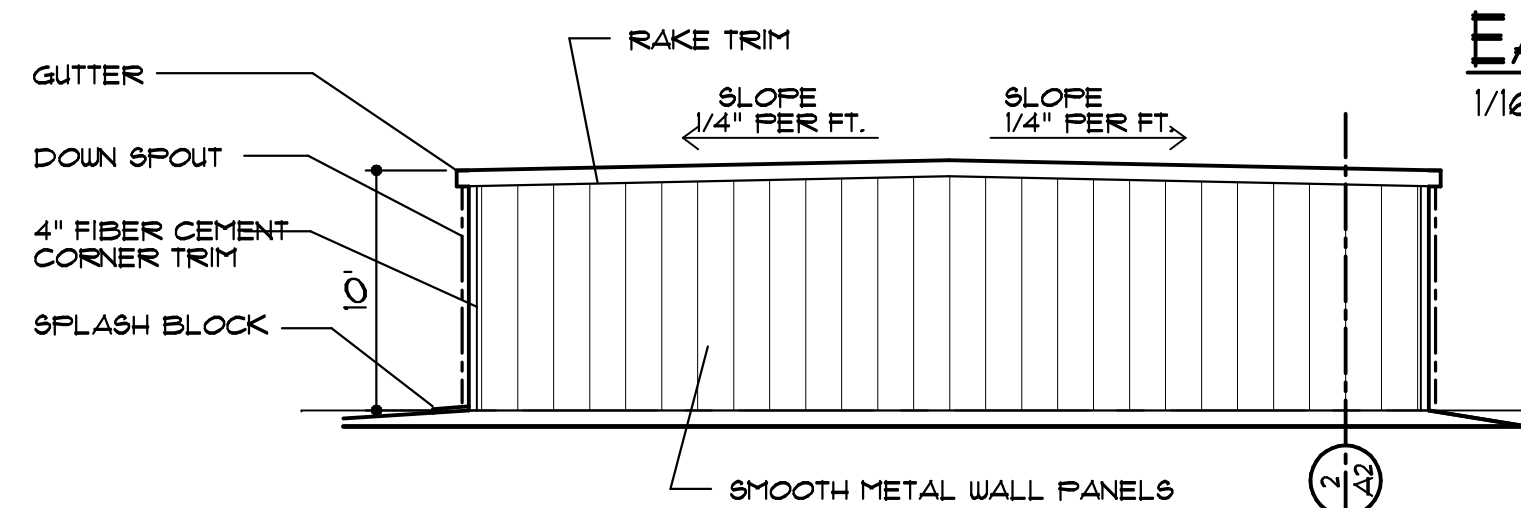

**NORTH ELEVATION**  
 1/8" = 1'-0"

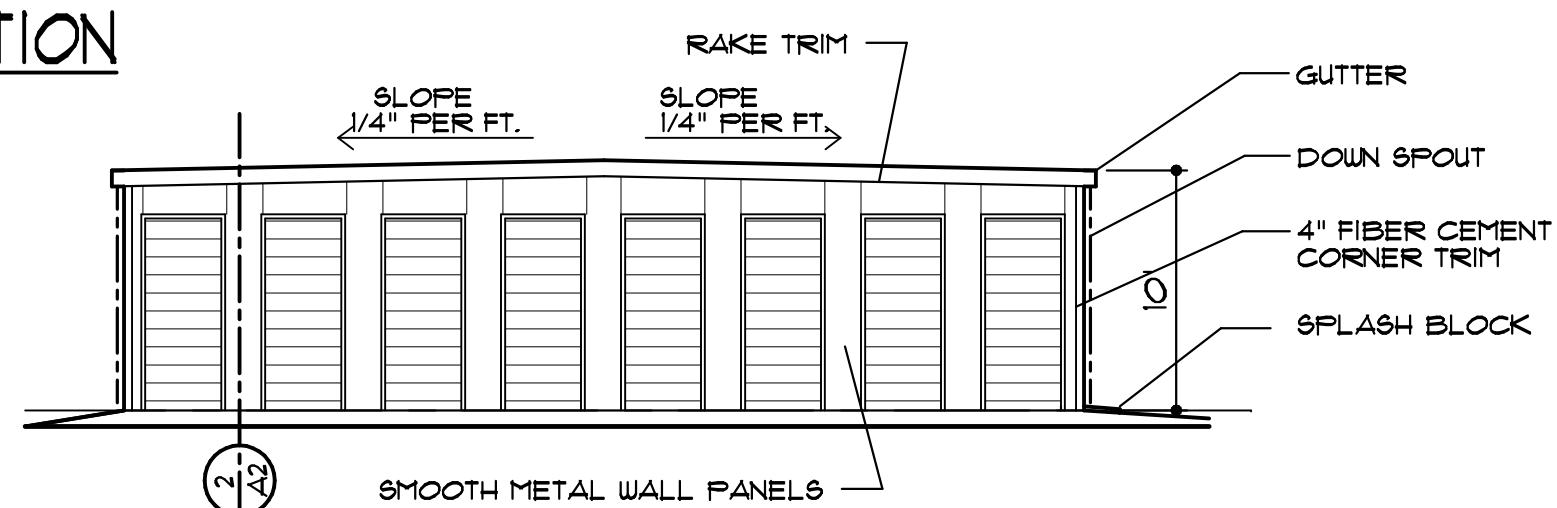

**SOUTH ELEVATION**  
 1/8" = 1'-0"

ALL RAIN LEADER TO HAVE SPLASH BLOCKS

**DOWN SPOUTS & GUTTERS**  
 ROOF AREA = 13,500 SF  
 GUTTER LENGTH = 450' LF  
 GUTTER SIZE = 5" w x 4" d  
 # DOWN SPOUT (3" x 4") = 16  
 AREA PER DOWN SPOUT = 844 sf

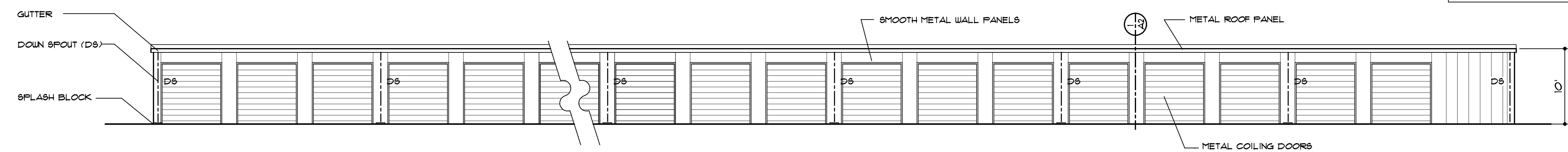

**PARTIAL WEST ELEVATION**  
 1/8" = 1'-0"

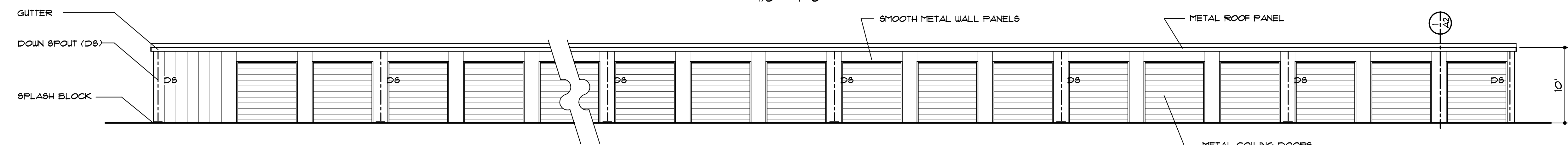

**PARTIAL EAST ELEVATION**  
 1/8" = 1'-0"

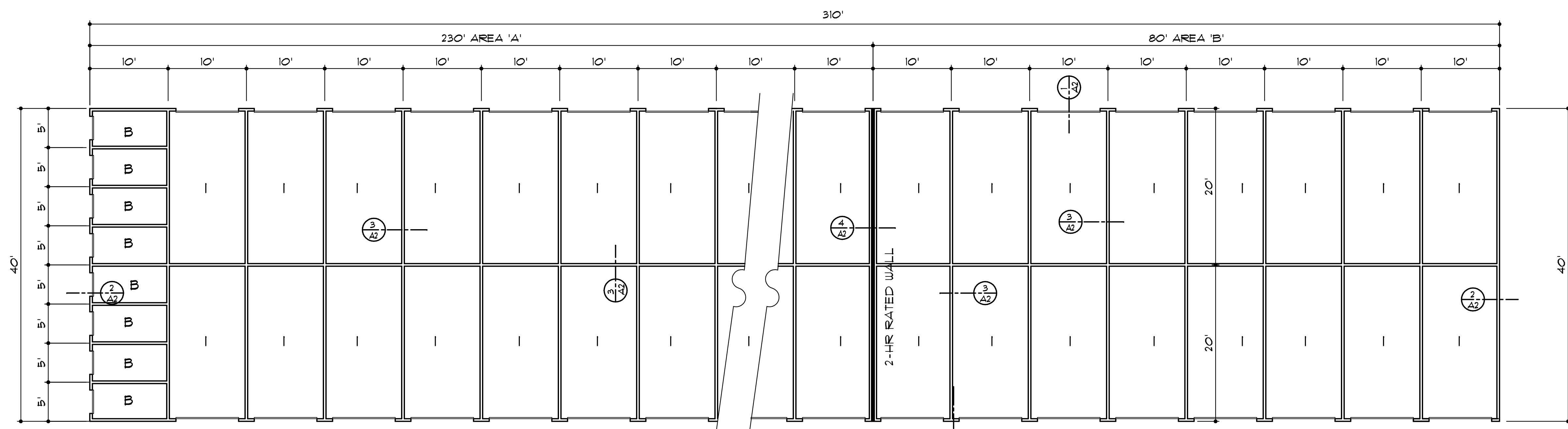

**FLOOR PLAN**  
 1/8" = 1'-0"

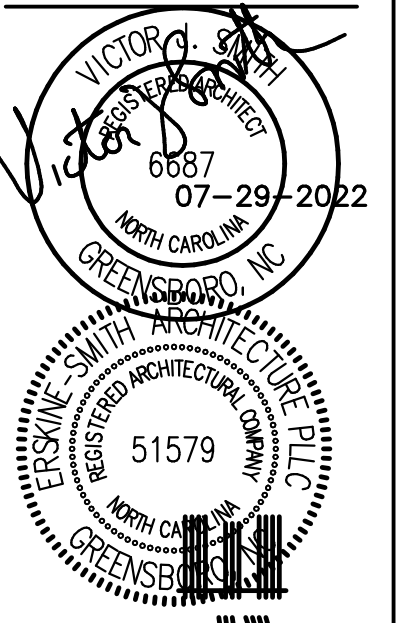

**NEW STORAGE FACILITY FOR HARNETT SELF STORAGE**  
 SPOUT SPRINGS, NC

REVISIONS	BY

DRAWN BY : VJS  
 CHECKED BY : VJS  
 DATE : 07-29-2022  
 SCALE : AS SHOWN  
 FILE :  
 SHEET NUMBER :

**BLDG. C 12,400. C**

**A-1**

THESE DRAWINGS ARE INSTRUMENTS OF SERVICE AND SHALL REMAIN THE PROPERTY OF THE ARCHITECT. THESE DRAWINGS ARE PROTECTED UNDER COPYRIGHT LAWS AND MAY NOT BE REPRODUCED IN PART OR IN WHOLE WITHOUT THE SPECIFIC WRITTEN CONSENT OF THE ARCHITECT.  
 © 2014 ERSKINE-SMITH Architecture, P.L.L.C.

**ERSKINE-SMITH ARCHITECTURE, P.L.L.C.**  
 architecture research planning  
 3406-A West Wendover Avenue  
 Greensboro, N.C. 27407  
 Phone (336) 855-1286 Fax 855-5602



**NEW STORAGE FACILITY FOR BLDG. 'C'**  
**HARNETT SELF STORAGE**  
 SPOUT SPRINGS, NC

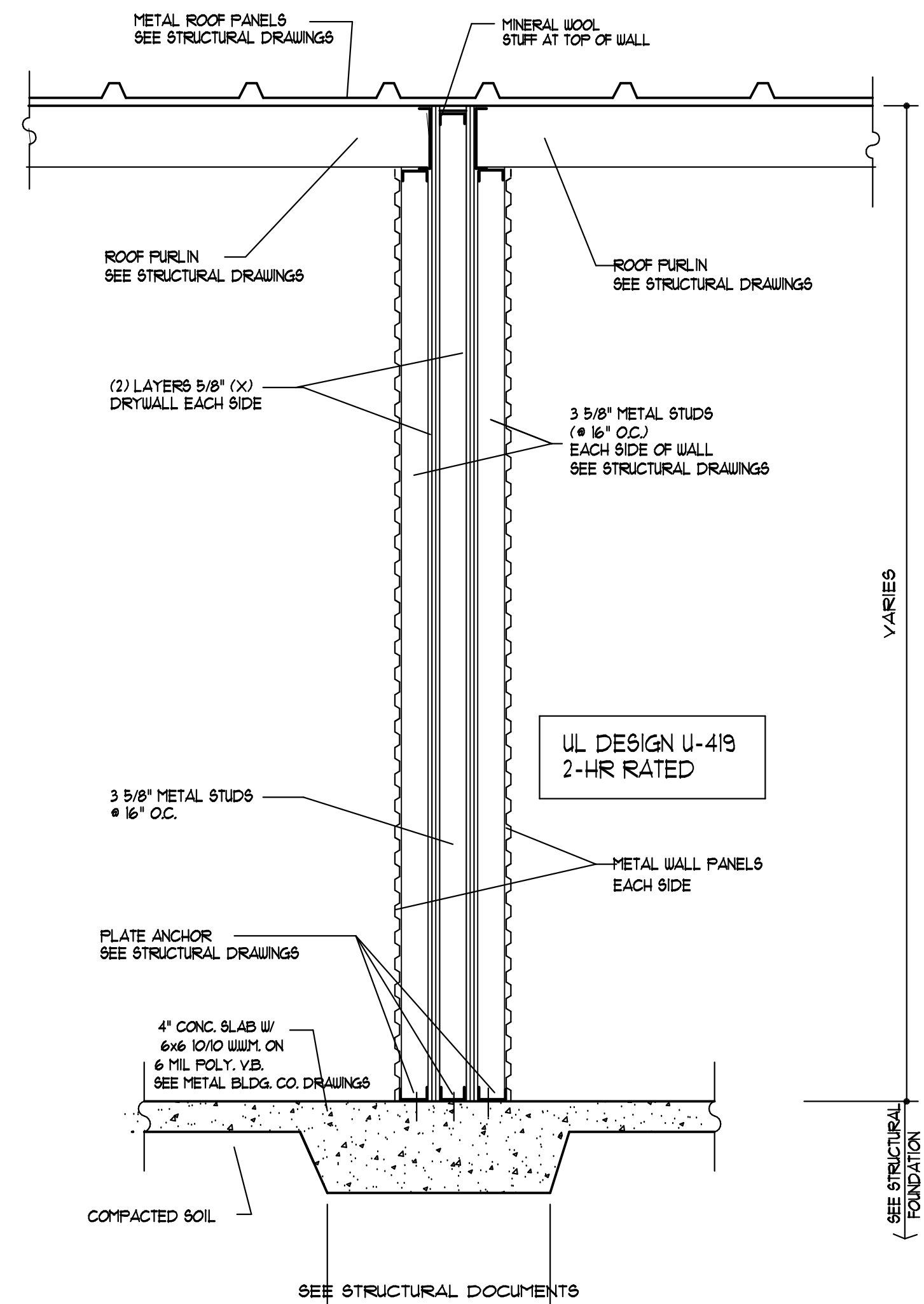

4  
A-2 **2-HR. RATED FIRE WALL DETAIL**

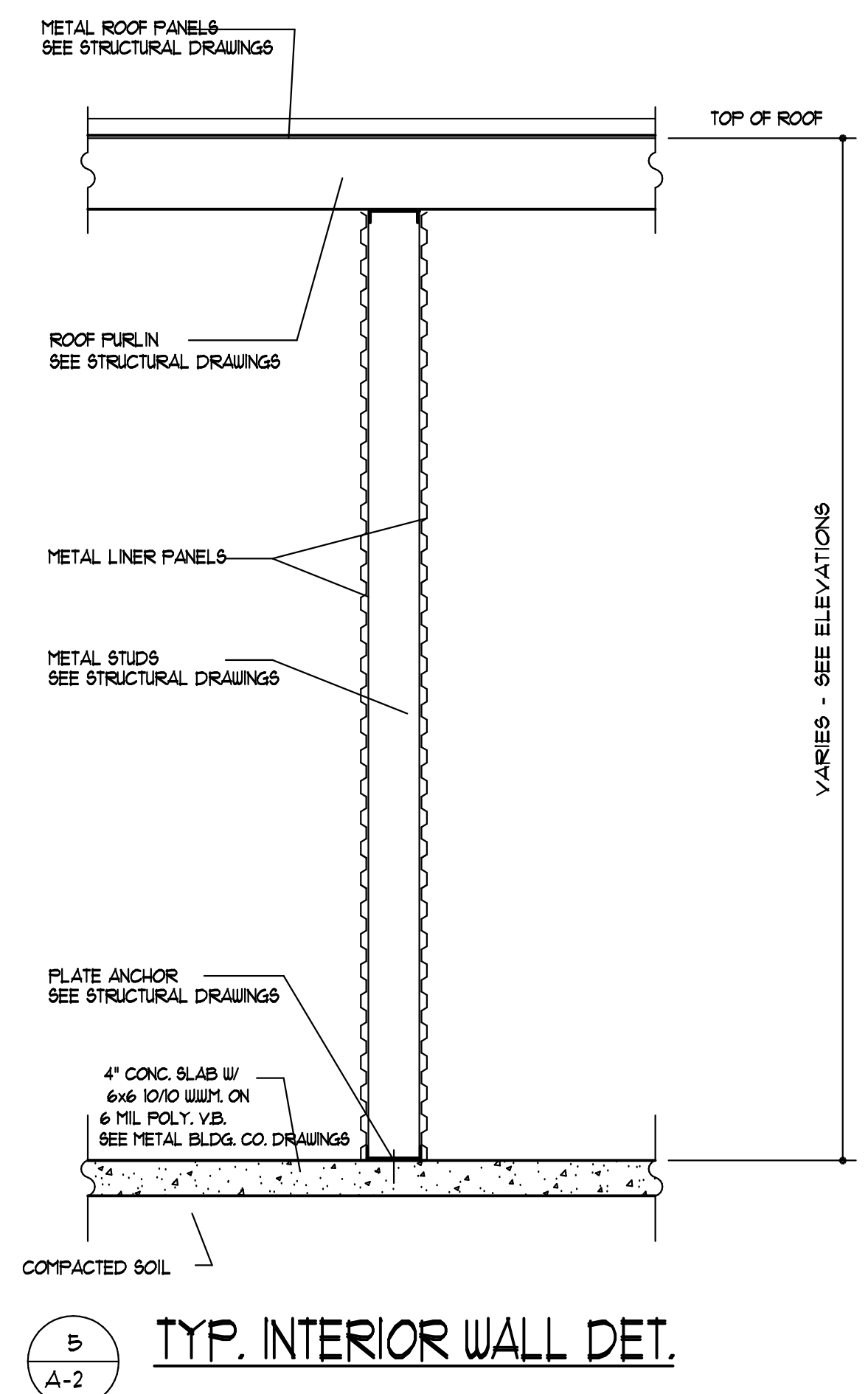

5  
A-2 **TYP. INTERIOR WALL DET.**

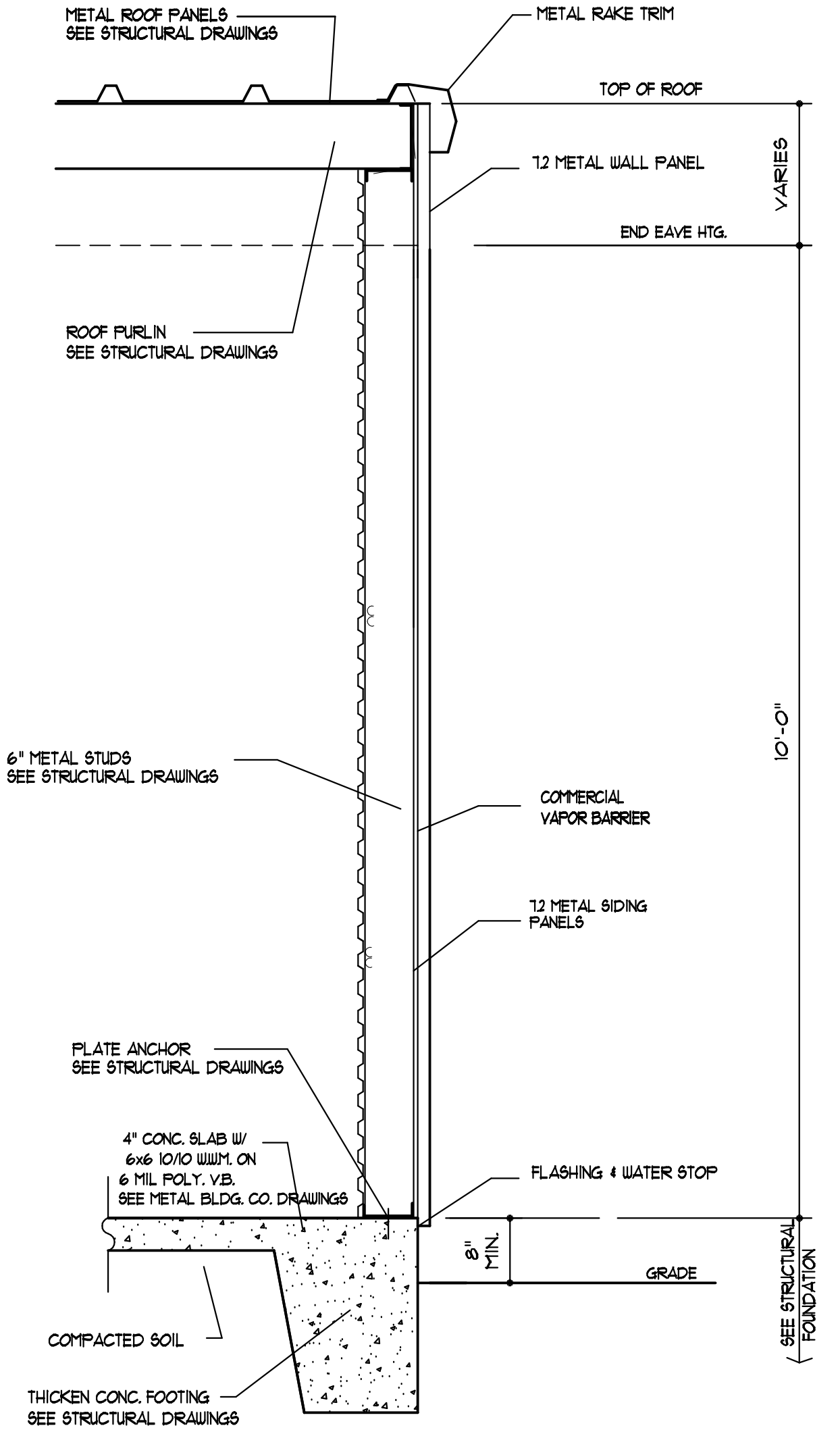

2  
A-2 **TYP. EXTERIOR END WALL DET.**

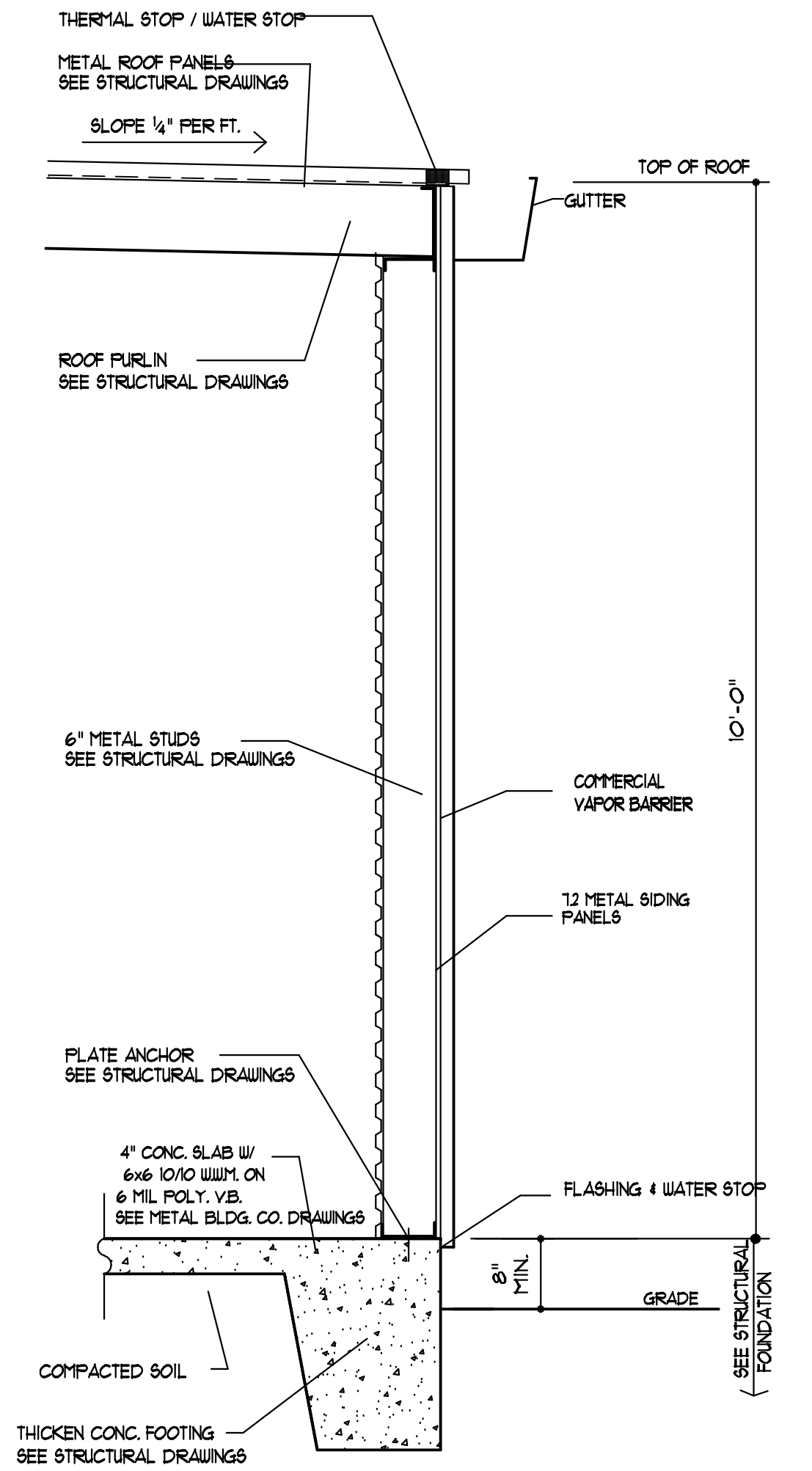

1  
A-2 **TYP. EXTERIOR WALL DET.**

NOTE: DO NOT SCALE DRAWINGS  
 PDF & PRINTING CHANGES ALLOWED

REVISIONS	BY

DRAWN BY: VJS  
 CHECKED BY: VJS  
 DATE: 07-29-2022  
 SCALE: 3/4" = 1'-0"  
 FILE:

SHEET NUMBER:  
**A-2**  
 BLDG. 'C'

# BUILDING 'J'

## NEW STORAGE FACILITY FOR

# HARNETT SELF STORAGE

## SPOUT SPRINGS, NC

THESE DRAWINGS ARE INSTRUMENTS OF SERVICE AND SHALL REMAIN THE PROPERTY OF THE ARCHITECT. THESE DRAWINGS ARE PROTECTED BY COPYRIGHT LAW AND MAY NOT BE REPRODUCED OR TRANSMITTED IN ANY FORM OR BY ANY MEANS, WITHOUT THE SPECIFIC WRITTEN CONSENT OF THE ARCHITECT.

© 2012 ERSKINE-SMITH ARCHITECTURE, P.L.L.C.

**ERSKINE-SMITH ARCHITECTURE, P.L.L.C.**  
 architecture research planning  
 Greensboro, N.C. 27407  
 Phone (336) 855-1286 Fax 855-5602

### APPENDIX "B" BUILDING CODE SUMMARY

Name of project: BLDG. 'J' NEW FACILITY FOR HARNETT SELF STORAGE  
 Address: \_\_\_\_\_ Zip Code: \_\_\_\_\_  
 Owner or Authorized Agent: VC SMITH Phone: 336-855-1286 E-mail: erskinesmith@earthlink.net  
 Owned By:  City/County  Private  State  
 Code Enforcement Jurisdiction:  City  SAITFORD  County

CONTACT: Victor J. Smith  
 DESIGNER: FIRM NAME LICENSE NO. TELEPHONE NO. E-MAIL ADDRESS  
 Architectural: ERSKINE-SMITH ARCHITECTURE, P.L.L.C. Victor J. Smith 336-855-1286 erskinesmith@earthlink.net  
 Civil: \_\_\_\_\_  
 Electrical: \_\_\_\_\_  
 Fire Alarm: \_\_\_\_\_  
 Plumbing: \_\_\_\_\_  
 Mechanical: \_\_\_\_\_  
 Sprinkler/Standpipe: \_\_\_\_\_  
 Structural: \_\_\_\_\_  
 Retaining Walls >8' High: \_\_\_\_\_  
 Other: \_\_\_\_\_

2018 NC BUILDING CODE:  New Building  Addition  Renovation  
 1st Time Interior Completion  
 Shell/Core - Contact the local inspection jurisdiction for possible additional procedures and requirements  
 Phased Construction - Shell/Core - Contact the local inspection jurisdiction for possible additional procedures and requirements

2018 NC EXISTING BUILDING CODE, EXISTING:  Prescriptive  Repair  Chapter 14  
 Alterations:  Level I  Level II  Level III  
 Historic Property  Change of Use

CONSTRUCTION (date): \_\_\_\_\_ ORIGINAL OCCUPANCY (Ch. 3): \_\_\_\_\_  
 RENOVATED (date): \_\_\_\_\_ PROPOSED OCCUPANCY (Ch. 3): **10/J STORAGE**  
 RISK CATEGORY (Table 1604.3): Current  I  II  III  IV Proposed  I  II  III  IV

BASIC BUILDING DATA  
 Construction Type:  I-A  I-B  II-A  II-B  III-A  III-B  IV  V-A  V-B  
 Sprinklers:  No  Partial  Yes  NFPA 13  NFPA 13R  NFPA 13D  
 Standpipes:  No  Yes Class:  I  II  III  Wet  Dry  
 Fire District:  No  Yes Flood Hazard Area:  No  Yes  
 Special Inspections Required:  No  YES (Contact the local inspection jurisdiction for additional procedures and requirements)  
 Manual Fire Alarm System with Notification:  No  Yes

FLOOR	EXISTING (SQ FT)	NEW (SQ FT)	SUB-TOTAL
4th Floor			
3rd Floor			
2nd Floor			
Mezzanine	AREA 'A'	AREA 'B'	
1st Floor	6,540 sf	6,360 sf	
Basement			
TOTAL	6,540 sf	6,360 sf	13,500 sf TOTAL

Primary Occupancy Classification(s): **ALLOWABLE AREA**  
 Assembly  A-1  A-2  A-3  A-4  A-5  
 Business  B-1  B-2  B-3  B-4  
 Educational  E-1  E-2  E-3  
 Factory  F-1  F-2  F-3  
 High Hazard  H-1  H-2  H-3  H-4  H-5  
 Institutional  I-1  I-2  I-3  
 Mercantile  M-1  M-2  M-3  M-4  
 Residential  R-1  R-2  R-3  R-4  
 Storage  S-1  S-2  S-3  
 Utility and Miscellaneous  U-1  U-2  U-3

Accessory Occupancy Classification(s): \_\_\_\_\_  
 Special Uses (Chapter 4 - List Code Sections): \_\_\_\_\_  
 Special Provisions (Chapter 5 - List Code Sections): \_\_\_\_\_  
 Mixed Occupancy:  No  Yes Separation:  Hr. Exception: \_\_\_\_\_

Non-separated Use (508.3)  
 The required type of construction for the building shall be determined by applying the height and area limitations for each of the applicable occupancies to the entire building. The most restrictive type of construction so determined shall apply to the entire building.  
 Separated Mixed Occupancy (508.4) - See below for area calculations  
 For each story, the area of the occupancy shall be such that the sum of the ratios of the actual floor area of each use divided by allowable floor area for each use shall not exceed 1.  

$$\frac{\text{Actual Area of Occupancy A}}{\text{Allowable Area of Occupancy A}} + \frac{\text{Actual Area of Occupancy E}}{\text{Allowable Area of Occupancy E}} \leq 1$$

STORY NO.	DESCRIPTION AND USE	(A) BLDG AREA PER STORY (ACTUAL)	(B) TABLE 506.2 AREA	(C) AREA PERCENTAGE INCREASE (1)	(D) ALLOWABLE AREA PER STORY (OR QUALIFIED 1)

(1) Frontage area increases from Section 506.2 are computed thus:  
 a. Perimeter which fronts a public way or open space having 20 feet minimum width = \_\_\_\_\_ (F)  
 b. Total Building Perimeter = \_\_\_\_\_ (P)  
 c. Ratio (F/P) = \_\_\_\_\_ (F/P)  
 d. W = Minimum width of public way = \_\_\_\_\_ (W)  
 e. Percent of frontage increase =  $\frac{(F/P) \times W \times 100}{(F/P) - 0.25} \times W \times 30 = \dots \%$   
 (2) Unlimited area applicable under conditions of Section 507  
 (3) Maximum Building Area = total number of stories in the building x D (506.2)  
 (4) The maximum area of open parking garages must comply with 406.5.4. The maximum area of air traffic control towers must comply with 403.3  
 (5) Frontage increase is based on the unspinklered area value in Table 506.2

ALLOWABLE HEIGHT	Allowable		Code Reference
	Building Height in Feet (Table 504.3)	Building Height in Stories (Table 504.4)	
	55 FT.	2	

Provide code reference if the "shown on Plans" quantity is not based on Table 504.3 or 504.4.

NS = BUILDING NOT EQUIPPED THROUGHOUT WITH AN AUTOMATIC SPRINKLER SYSTEM

### FIRE PROTECTION REQUIREMENTS

BUILDING ELEMENT	FIRE SEPARATION DISTANCE (FEET)	RATING PROVIDED	RATING REDUCTION	DETAIL AND SHEET #	DESIGN FOR RATED ASSEMBLY	DESIGN FOR RATED PENETRATION	DESIGN FOR RATED JOINTS
Structural Framing, including columns, girders, trusses		0					
Bearing walls							
Exterior							
NORTHWEST	6'-6"	0					
NORTHEAST	6'-6"	0					
SOUTHWEST WALL (ASSUMED PROPERTY LINE)	15'	0					
SOUTHWEST WALL	3'-6"	0					
Interior							
Nonbearing walls and partitions							
Exterior walls							
North	N/A	0					
East	N/A	0					
West	N/A	0					
South	N/A	0					
Interior walls & partitions							
Floor construction including supporting beams and joists							
Floor Ceiling Assembly							
Columns Supporting Roof							
Roof construction including supporting beams and joists							
Floor Ceiling Assembly							
Columns Supporting Roof							
Roof construction including supporting beams and joists							
Columns Supporting Roof							
Roof Ceiling Assembly							
Columns Supporting Roof							
Shafts Enclosures - Exit	N/A						
Shafts Enclosures - Other	N/A						
Corridor Separation	N/A						
Occupancy/Fire Barrier Separation	N/A						
Party/Fire Wall Separation	2-hr	2-hr	U-419	3/A-3			
Smoke Barrier Separation	N/A						
Tenant / Dwelling Unit / Sleeping Unit Separation	N/A						
Incidental Use Separation	N/A						

### PERCENTAGE OF WALL OPENINGS CALCULATION

Fire Separation Distance (feet) (See Property Line)	Degree of Opening Protection (Table 1008.6)	Allowable Area	Actual Shown on Plan (%)
NORTH 35'	UNPROTECTED, NONSPRINKLERED	NO LIMIT PER TABLE 705.8.1 ex. 2	51%
WEST 15'	UNPROTECTED, NONSPRINKLERED	NO LIMIT PER TABLE 705.8.1 ex. 2	47%
SOUTH 25'	UNPROTECTED, NONSPRINKLERED	NO LIMIT PER TABLE 705.8.1 ex. 2	0
EAST 122'	UNPROTECTED, NONSPRINKLERED	NO LIMIT PER TABLE 705.8.1 ex. 2	0

### LIFE SAFETY PLAN REQUIREMENTS

Life Safety Plan Sheet = COVER SHEET  
 Fire and/or smoke rated wall locations (Chapter 7)  
 Assumed and real property line locations (if not on site plan)  
 Exterior wall opening areas with respect to distance to assumed property lines (1008.6)  
 Occupancy use for each area as it relates to occupancy load calculation (Table 1004.1.2)  
 Occupant loads for each area  
 Exit access travel distance (1017)  
 Common path of travel distance (Table 1006.2.1 & 1006.3.2(1))  
 Actual occupant load for each exit door  
 A separate schematic plan indicating where fire rated floor ceiling and/or roof structure is provided for purposes of occupancy separation  
 Location of doors with panic hardware (1010.10)  
 Location of doors with delayed egress locks and the amount of delay (1010.1.1.1)  
 Location of doors with electromagnetic egress locks (1010.13.3)  
 Location of doors equipped with hold-open devices  
 Location of emergency escape windows (1020)  
 The square footage of each fire area (1021)  
 The square footage of each smoke compartment for Occupancy Classification 1-2 (401B)  
 Note any code exceptions or table notes that may have been utilized regarding the items above

### ACCESSIBLE DUELLING UNITS (Section 1107)

TOTAL UNITS	ACCESSIBLE UNITS REQUIRED	ACCESSIBLE UNITS PROVIDED	TYPE 'A' UNITS REQUIRED	TYPE 'A' UNITS PROVIDED	TYPE 'B' UNITS REQUIRED	TYPE 'B' UNITS PROVIDED	TOTAL ACCESSIBLE UNITS PROVIDED

### ACCESSIBLE PARKING (Section 1106)

LOT OR PARKING AREAS	TOTAL # OF PARKING SPACES REQUIRED	* OF ACCESSIBLE SPACES PROVIDED		TOTAL NO. ACCESSIBLE SPACES PROVIDED
		REGULAR UNITS BY ACCESSIBLE	VAN SPACES WITH BY ACCESSIBLE BY ACCESSIBLE	
TOTAL	SEE SITE PLAN			

### PLUMBING FIXTURE REQUIREMENTS (Table 2902.1)

USE	WATER CLOSETS		URINALS		LAVATORIES		SHOWERS		DRINKING FOUNTAINS	
	MALE	FEMALE	UNSEX	UNSEX	MALE	FEMALE	UNSEX	TUBS	REGULAR	ACCESSIBLE
OUTSIDE										
INSIDE										
TOTAL										

### SPECIAL APPROVALS

Special approval: (Local Jurisdiction, Department of Insurance, OIG, DPI, DHH, ICC, etc., describe below)

### ENERGY REQUIREMENTS

The following data shall be considered minimum and any special attributes required to meet the energy code shall also be provided. Each Designer shall furnish the required portions of the project information for the plan data sheet. If performance method, state the annual energy cost standard reference design vs annual energy cost for the proposed design.

Climate Zone **3**  4  5  
 Method of Compliance  
 Prescriptive (Energy Code)  
 Performance (Energy Code)  
 Prescriptive (ASHRAE 90.1)  
 Performance (ASHRAE 90.1)

### THERMAL ENVELOPE

Roof/Ceiling Assembly (each assembly)  
 Description of assembly: \_\_\_\_\_  
 U-value of total assembly: \_\_\_\_\_  
 U-value of insulation: \_\_\_\_\_  
 Skylights in each assembly: \_\_\_\_\_  
 U-value of skylight: \_\_\_\_\_  
 total square footage of skylights in each assembly: \_\_\_\_\_

Exterior Walls (each assembly)  
 Description of assembly: \_\_\_\_\_  
 U-value of total assembly: \_\_\_\_\_  
 U-value of insulation: \_\_\_\_\_  
 Openings in each assembly: \_\_\_\_\_  
 U-value of door: \_\_\_\_\_  
 U-value of window: \_\_\_\_\_  
 U-value of skylight: \_\_\_\_\_  
 U-value of glass: \_\_\_\_\_  
 U-value of glazing: \_\_\_\_\_  
 U-value of glass block: \_\_\_\_\_  
 U-value of glass curtain wall: \_\_\_\_\_  
 U-value of glass entrance canopy: \_\_\_\_\_  
 U-value of glass entrance porch: \_\_\_\_\_  
 U-value of glass entrance vestibule: \_\_\_\_\_  
 U-value of glass entrance porch: \_\_\_\_\_  
 U-value of glass entrance vestibule: \_\_\_\_\_  
 U-value of glass entrance porch: \_\_\_\_\_  
 U-value of glass entrance vestibule: \_\_\_\_\_

Walls below grade (each assembly)  
 Description of assembly: \_\_\_\_\_  
 U-value of total assembly: \_\_\_\_\_  
 R-value of insulation: \_\_\_\_\_  
 R-value of insulation: \_\_\_\_\_

Floors over unconditioned space (each assembly)  
 Description of assembly: \_\_\_\_\_  
 U-value of total assembly: \_\_\_\_\_  
 R-value of insulation: \_\_\_\_\_  
 R-value of insulation: \_\_\_\_\_

### STRUCTURAL DESIGN

DESIGN LOADS:  
 Importance Factors: Snow (Is) \_\_\_\_\_  
 Seismic (Is) \_\_\_\_\_  
 Live Loads: Roof \_\_\_\_\_ psf  
 Mezzanine \_\_\_\_\_ psf  
 Floor \_\_\_\_\_ psf  
 Ground Snow Load: \_\_\_\_\_ psf  
 Wind Loads: Ultimate Wind Speed (ASCE-7) \_\_\_\_\_  
 Exposure Category \_\_\_\_\_

### SEISMIC DESIGN CATEGORY

Provide the following Seismic Design Parameters:  
 Risk Category (Table 1604.5)  I  II  III  IV  
 Spectral Response Acceleration Coefficient (ASCE-7)  A  B  C  D  E  F  
 Site Classification (ASCE-7)  I  II  III  IV  V  VI  
 Basic structural analysis (check one):  
 Dual w/ Special Moment Frame  
 Dual w/ Special Moment Frame  
 Dual w/ Intermediate RC or Special Steel  
 Inverted Pendulum  
 Other: \_\_\_\_\_

### LATERAL DESIGN CONTROL

Earthquake (Lower Level - Bldg. A & B)  
 Wind (Upper Level - Bldg. A & B and C & D)

### SOIL BEARING CAPACITIES

Field Test (provide copy of test report) \_\_\_\_\_ psf  
 File size, type, and capacity \_\_\_\_\_

### UNIT MIX - TOTAL 4 BLDG.

SIZE	MARK	BUILDING TYPE				TOTAL	ACCESSIBLE UNITS
		A	B	C	J		
5'x5'	A	4	-	-	-	66	
5'x10'	B	13	6	8	-	81	BLDG. A
10'x10'	G	105	-	-	-	81	BLDG. B
10'x15'	I	24	52	-	-	183	BLDG. A
10'x20'	J	16	-	60	-	88	BLDG. B
10'x30'	K	-	-	-	26	44	BLDG. J
12'x30'	L	-	-	-	15	30	BLDG. J
TOTAL		162	58	68	44	332	
NET SQ. FT. PER BLDG.		18,284	8,100	12,400	13,500	52,284	SQ. FT. NET TOTAL
GROSS SQ. FT. PER BLDG.		23,508	8,100	12,400	13,500	57,508	SQ. FT. GROSS TOTAL

### UNIT CALCULATIONS

CODE REQUIREMENTS	PERCENTAGE	# OF UNITS	# OF ADA UNITS REQ.
5% OF THE FIRST 200 UNITS	5%	200	10
2% OF REMAINING UNITS	2%	132	2.64
TOTAL		332	3

NOTE: ALL ACCESSIBLE STORAGE UNIT DOORS SHALL HAVE A MAX. 5 LB. FULL

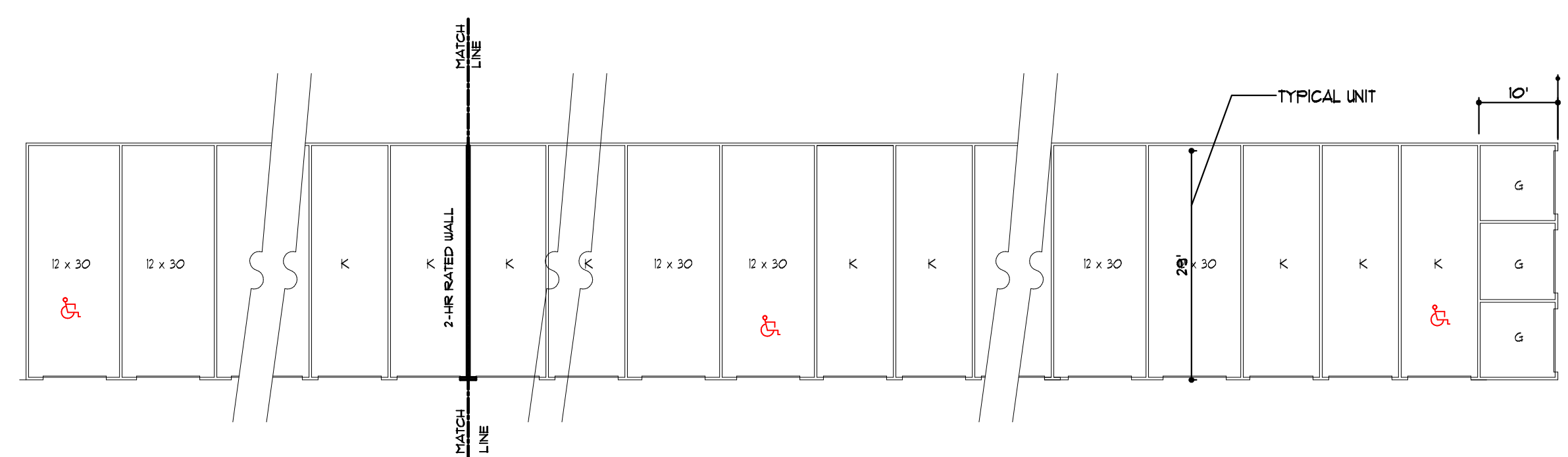

### LIFE SAFETY & OCCUPANCY PLAN

1/16" = 1'-0"

OCCUPANCY STORAGE  
 13,500 SF / 500 = 27

NOTE:  
 ADA UNITS WILL INCLUDE AN ELECTRIC DOOR LIFT OPERATOR WITH BATTERY BACKUP, PHOTO EYES, EMERGENCY RELEASE AND KEYPAD FOR OPERATION. KEYPAD WILL BE MOUNTED WITHIN ACCESSIBLE REACH RANGES PER ANSI 308. MANUFACTURER: LIFTMASTER 8850U OR EQUAL  
 HORIZONTAL SLIDING DOORS SHALL COMPLY WITH SECTION 1010.1.4.3 OF NCBC. ELECTRICAL TO BE COORDINATED.  
 OCCUPANT DISPERSAL FROM EXITS TO PUBLIC ROAD SHOWN ON SITE PLAN

# BUILDING 10/J

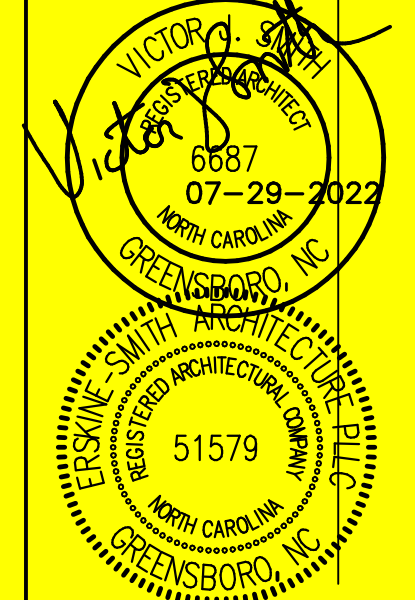

**NEW STORAGE FACILITY FOR BLDG. 'J'**  
**HARNETT SELF STORAGE**  
**SPOUT SPRINGS, NC**

REVISIONS BY

NO.	DATE	BY	DESCRIPTION

DRAWN BY: VJS  
 CHECKED BY: RHE  
 DATE: 07-29-2022  
 SCALE: 1/16" = 1'-0"  
 FILE:  
 SHEET NUMBER:  
**COVER BLDG. J**

THESE DRAWINGS ARE INSTRUMENTS OF SERVICE AND SHALL REMAIN THE PROPERTY OF THE ARCHITECT. THESE DRAWINGS ARE PROTECTED UNDER COPYRIGHT LAWS AND MAY NOT BE REPRODUCED IN PART OR IN WHOLE WITHOUT THE SPECIFIC WRITTEN CONSENT OF THE ARCHITECT.  
 © 2016 ERSKINE-SMITH ARCHITECTURE, PLLC

**ERSKINE-SMITH ARCHITECTURE**  
 architecture research planning  
 3406-A West Wendover Avenue  
 Greensboro, N.C. 27407  
 Phone (336) 855-1286 Fax 855-5602

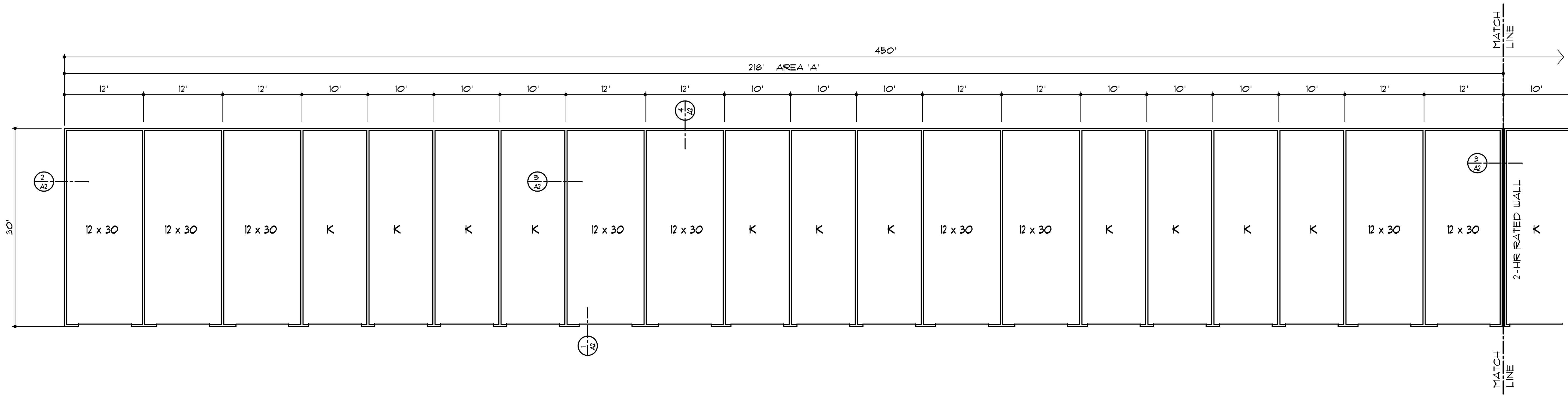
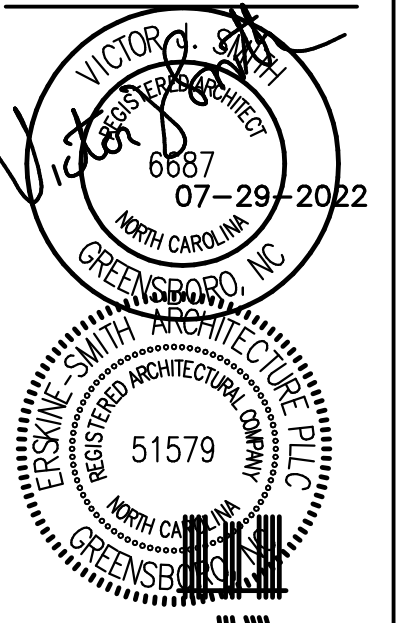

**PARTIAL FLOOR PLAN**  
 1/8" = 1'-0"

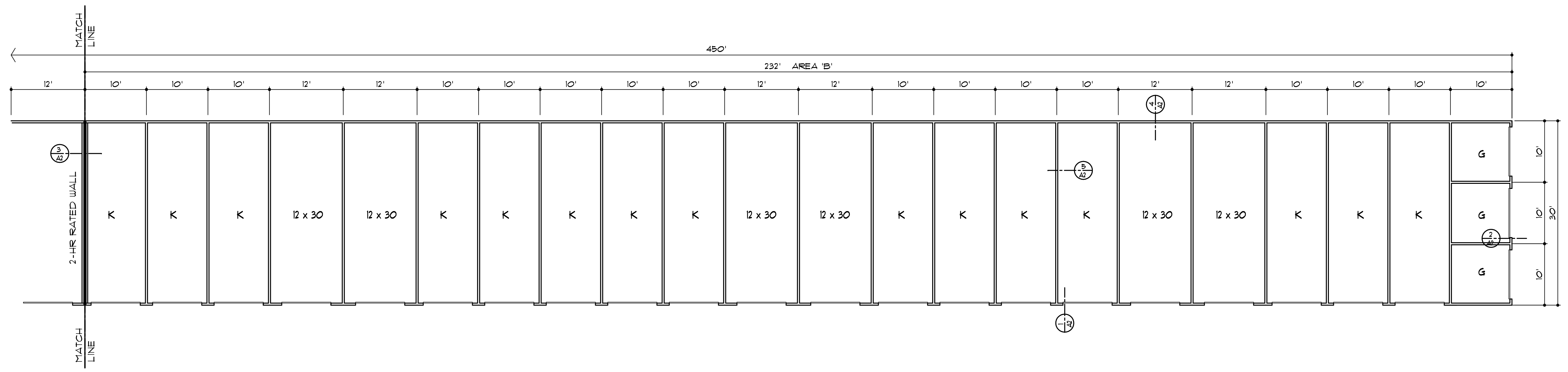

**PARTIAL FLOOR PLAN**  
 1/8" = 1'-0"

**BLDG. J 13,500 sf**

**NEW STORAGE FACILITY FOR  
 HARNETT SELF STORAGE  
 SPOUT SPRINGS, NC**

REVISIONS	BY

DRAWN BY : VJS  
 CHECKED BY : VJS  
 DATE : 07-29-2022  
 SCALE : AS SHOWN  
 FILE : ????  
 SHEET NUMBER :

**A-1**

THESE DRAWINGS ARE INSTRUMENTS OF SERVICE AND SHALL REMAIN THE PROPERTY OF THE ARCHITECT. THESE DRAWINGS ARE PROTECTED UNDER COPYRIGHT LAWS AND MAY NOT BE REPRODUCED IN PART OR IN WHOLE WITHOUT THE SPECIFIC WRITTEN CONSENT OF THE ARCHITECT.  
 © 2016 ERSKINE-SMITH ARCHITECTURE, PLLC

**ERSKINE-SMITH ARCHITECTURE**  
 architecture research planning  
 3406-A West Wendover Avenue  
 Greensboro, N.C. 27407  
 Phone (336) 855-1286 Fax 855-5602

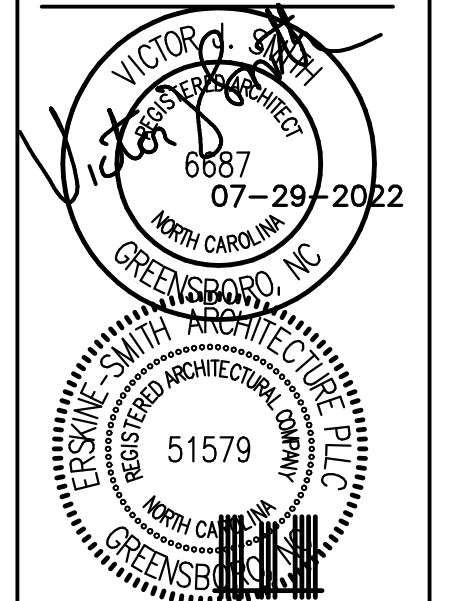

**NEW STORAGE FACILITY FOR HARNETT SELF STORAGE**  
 SPOUT SPRINGS, NC

REVISIONS	BY

DRAWN BY : VJS  
 CHECKED BY : VJS  
 DATE : 07-29-2022  
 SCALE : AS SHOWN  
 FILE :  
 SHEET NUMBER :

**A-2**

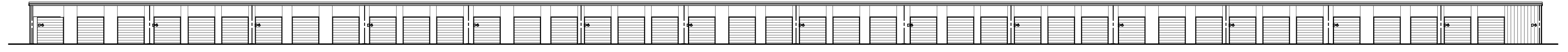

**NORTH ELEVATION**  
 1/16" = 1'-0"

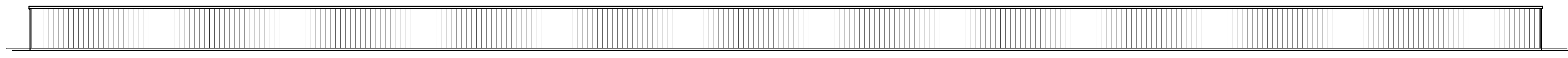

**SOUTH ELEVATION**  
 1/16" = 1'-0"

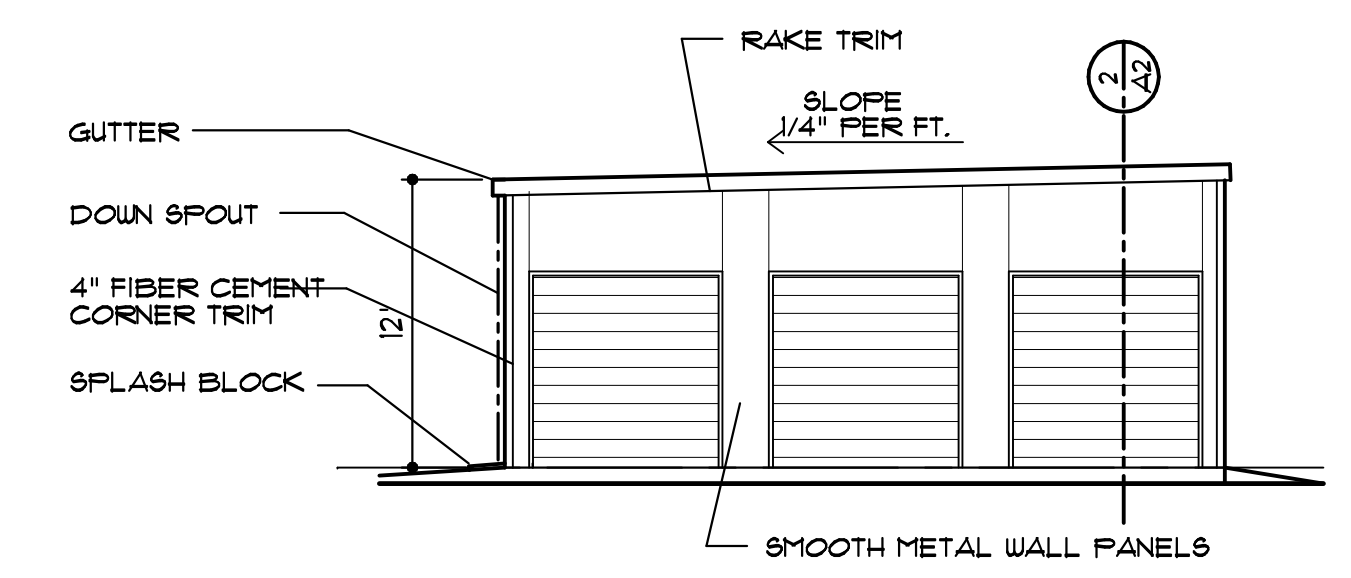

**WEST ELEVATION**  
 1/8" = 1'-0"

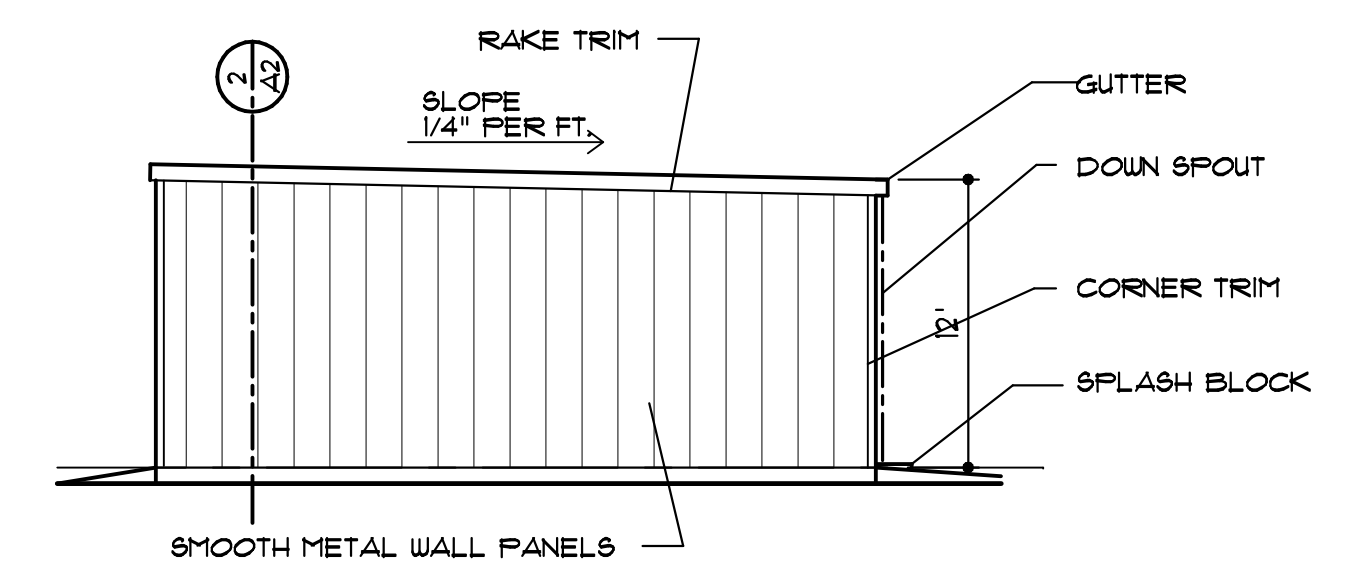

**EAST ELEVATION**  
 1/8" = 1'-0"

ALL RAIN LEADER TO HAVE SPLASH BLOCKS

**DOWN SPOUTS & GUTTERS**  
 ROOF AREA = 13,500 SF  
 GUTTER LENGTH = 450'LF  
 GUTTER SIZE = 5" w x 4" d  
 # DOWN SPOUT (3" x 4") = 16  
 AREA PER DOWN SPOUT = 844 sf

BUILDING 10

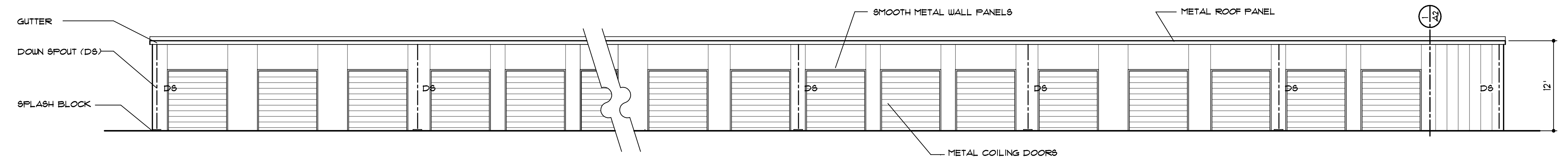

**PARTIAL NORTH ELEVATION**  
 1/8" = 1'-0"

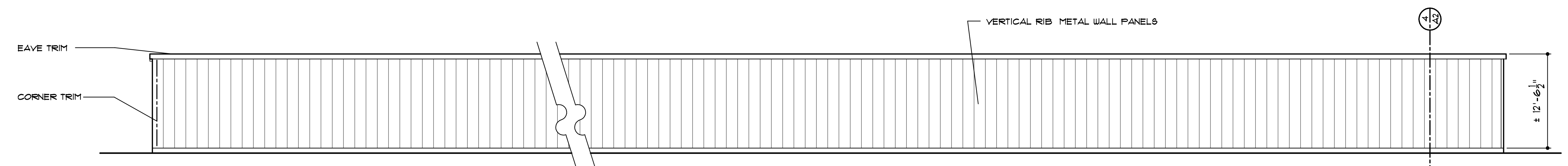

**PARTIAL SOUTH ELEVATION**  
 1/8" = 1'-0"

**BLDG. J**

THESE DRAWINGS ARE INSTRUMENTS OF SERVICE AND SHALL REMAIN THE PROPERTY OF THE ARCHITECT. THESE DRAWINGS ARE PROTECTED UNDER COPYRIGHT LAWS AND MAY NOT BE REPRODUCED IN PART OR IN WHOLE WITHOUT THE SPECIFIC WRITTEN CONSENT OF THE ARCHITECT.  
 © 2014 ERSKINE-SMITH ARCHITECTURE, P.L.L.C.

**ERSKINE-SMITH ARCHITECTURE, P.L.L.C.**  
 architecture research planning  
 3406-A West Wendover Avenue  
 Greensboro, N.C. 27407  
 Phone (336) 855-1286 Fax 855-5602



**NEW STORAGE FACILITY FOR HARNETT SELF STORAGE**  
 SPOUT SPRINGS, NC

REVISIONS	BY

DRAWN BY: VJS  
 CHECKED BY: VJS  
 DATE: 07-29-2022  
 SCALE: 3/4" = 1'-0"  
 FILE:  
 SHEET NUMBER:  
**A-3**  
 BLDG. 'J'

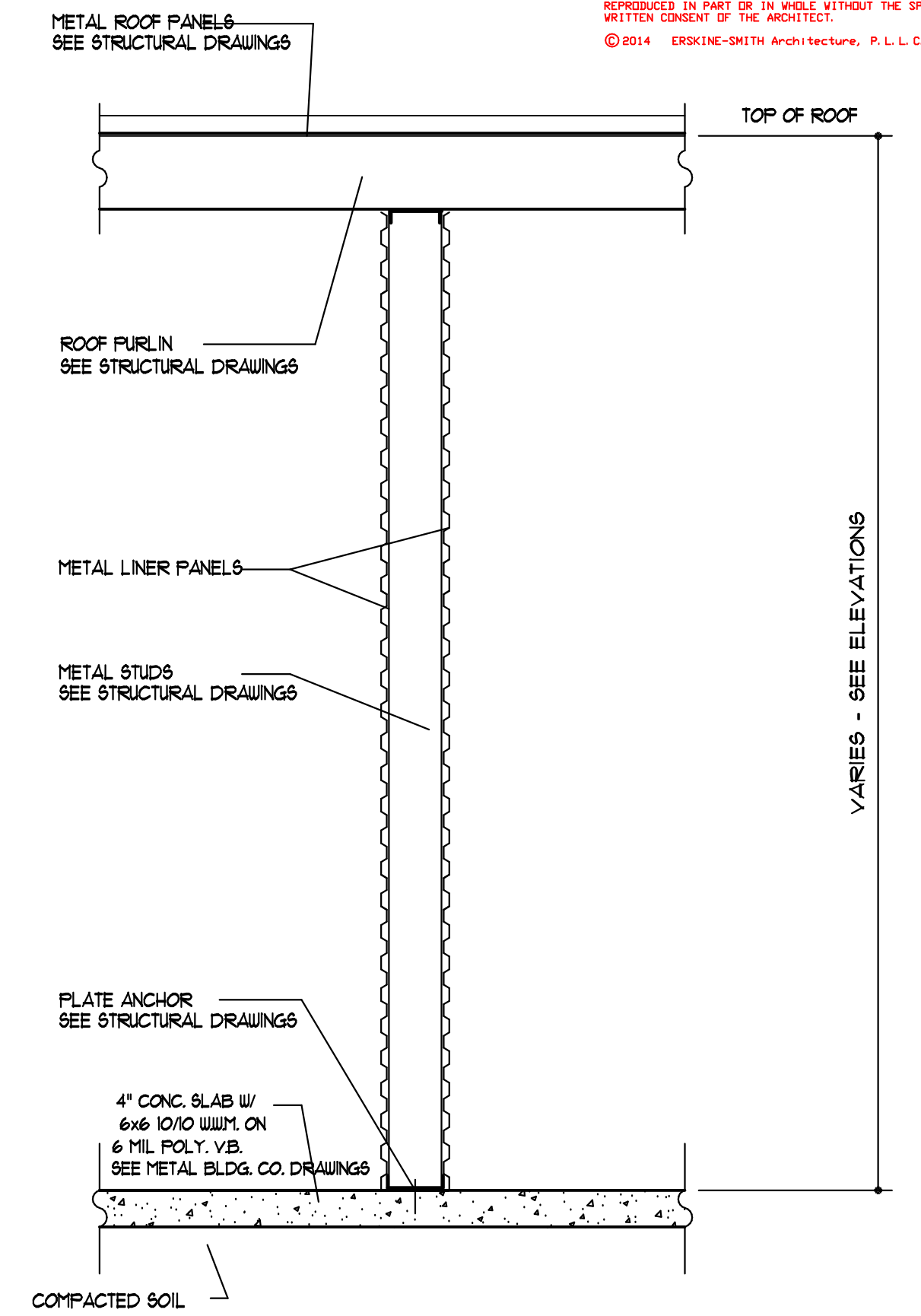

5  
 A-3 **TYP. INTERIOR WALL DET.**

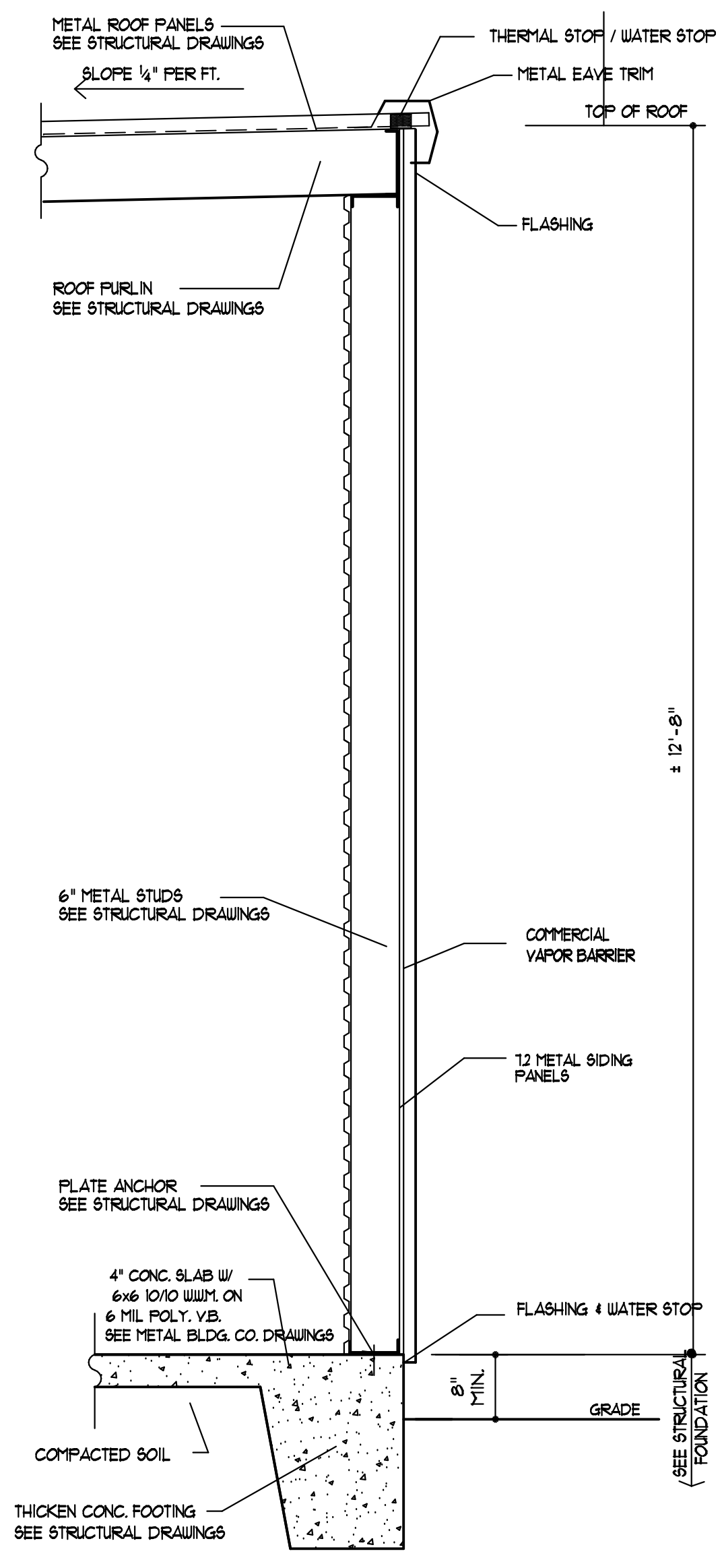

4  
 A-3 **TYP. EXTERIOR WALL DET.**

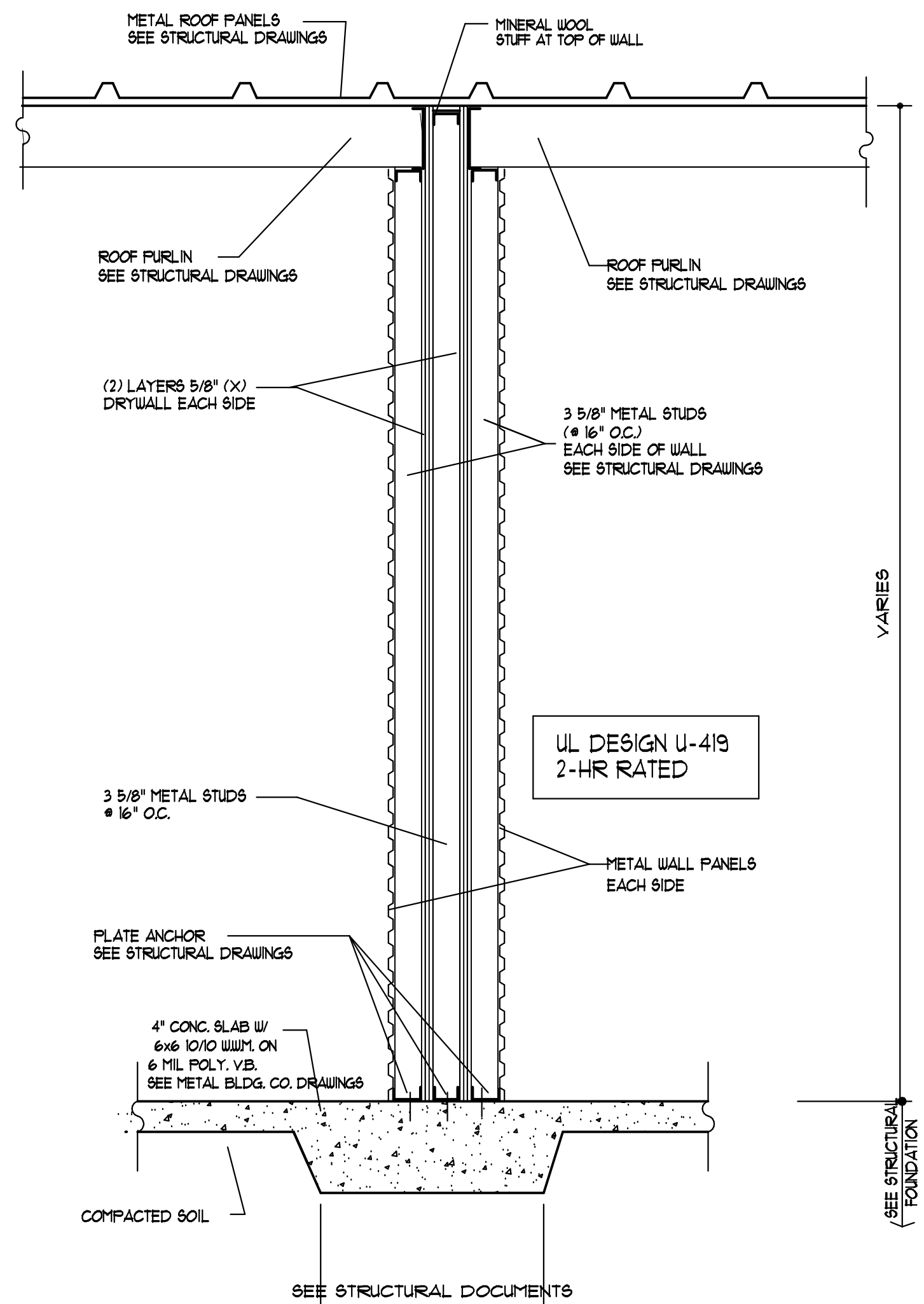

3  
 A-3 **2-HR. RATED FIRE WALL DETAIL**

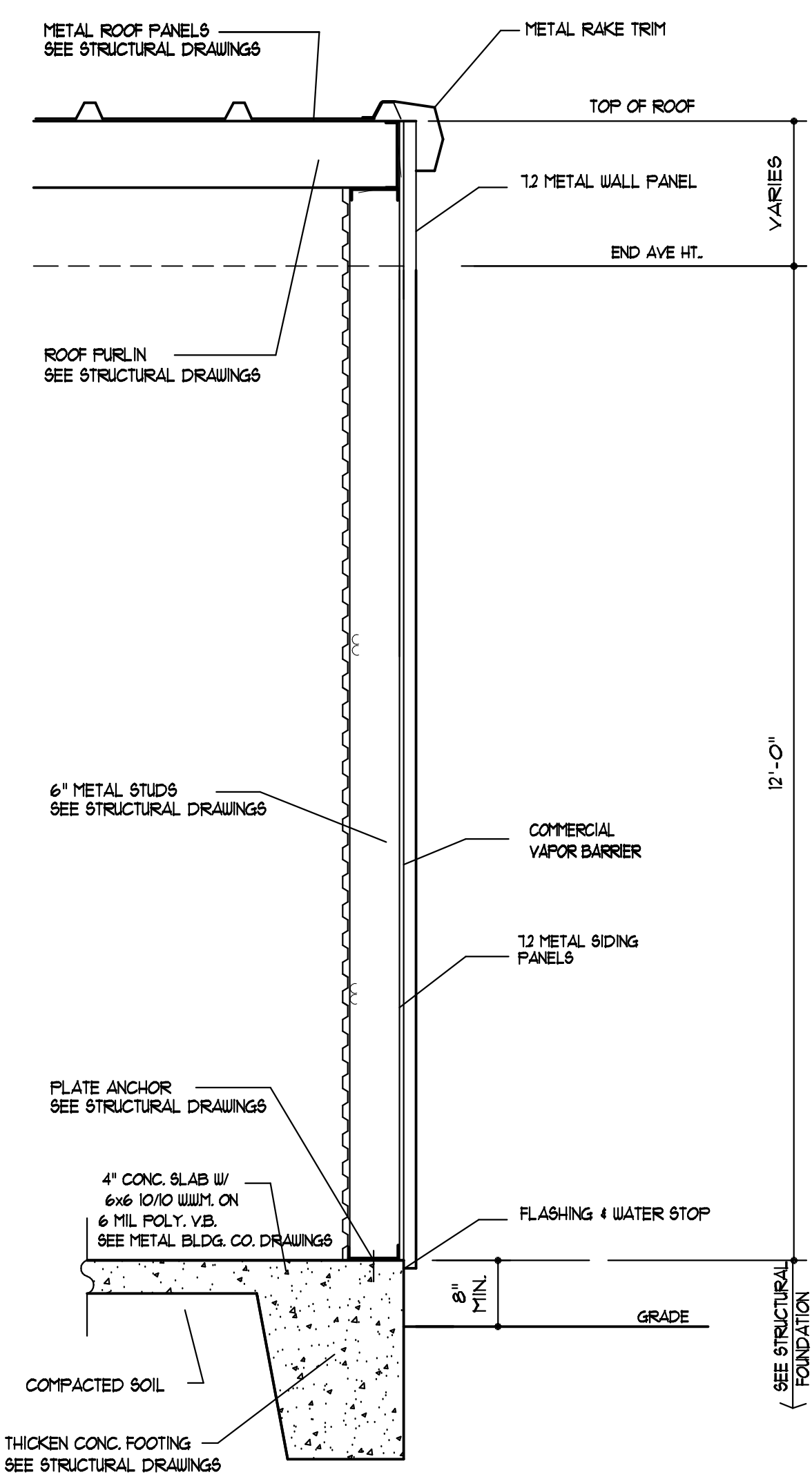

2  
 A-3 **TYP. EXTERIOR END WALL DET.**

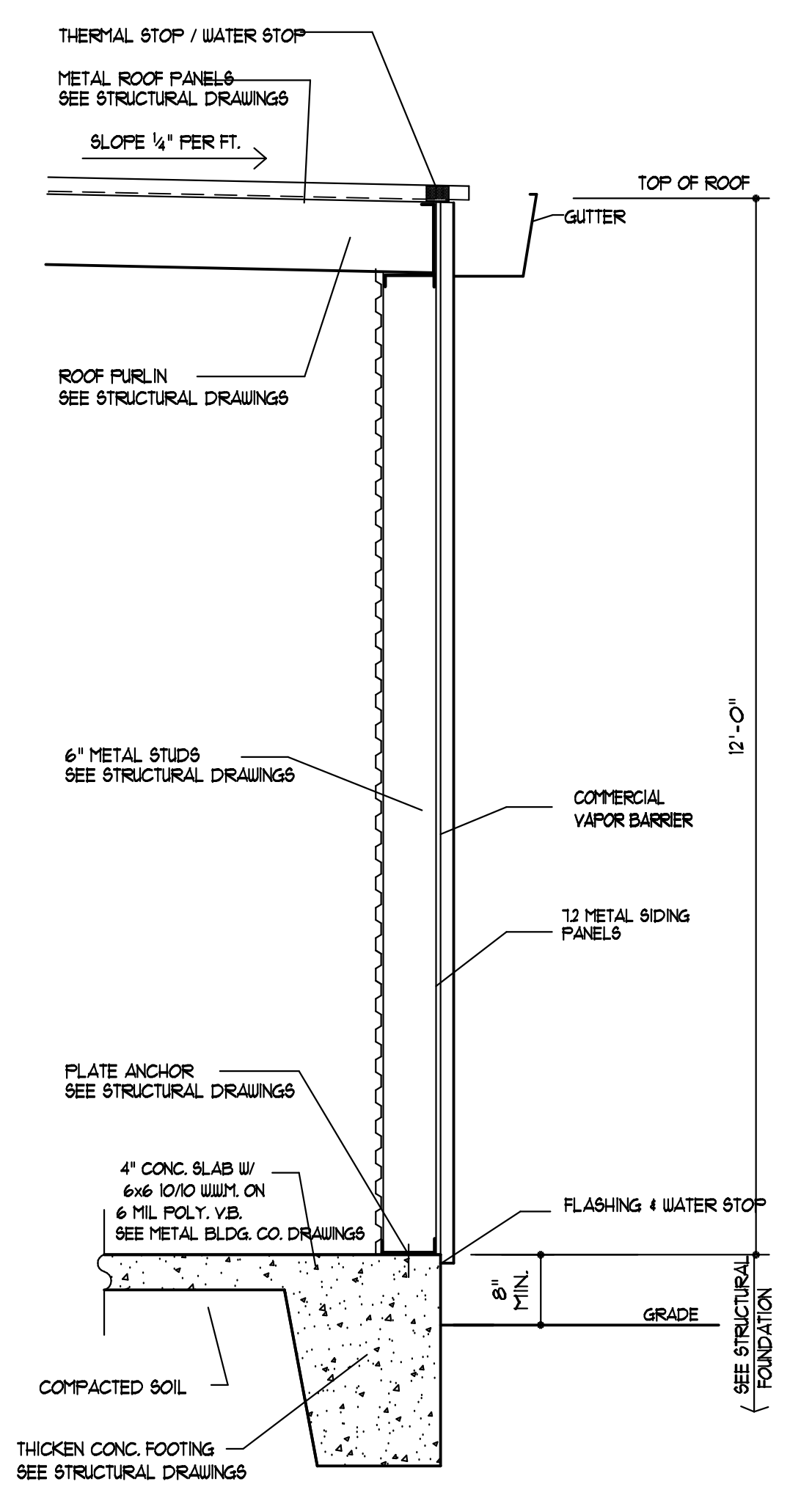

1  
 A-3 **TYP. EXTERIOR WALL DET.**

NOTE:  
 STRUCTURAL ENGINEER'S DESIGN  
 & DETAILS SHALL OVERRIDE  
 ARCHITECTURAL DETAILS

NOTE: DO NOT SCALE DRAWINGS  
 PDF & PRINTING CHANGES SCALE