

Ziad Qudwa
Custom Exempt Slaughterhouse
On-Site System
Engineered Option Permit

Harnett County

Application Package

Project No.: A67601.00

Submittal Date: July 9, 2019

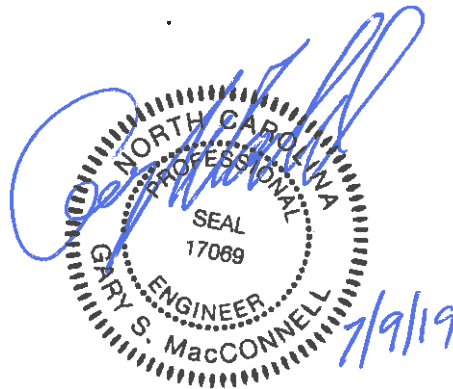

Prepared By:
MacConnell & Associates, P.C.

1101 Nowell Road, Suite 118
Raleigh, NC 27607

P.O. Box 129
Morrisville, NC 27560

Table of Contents

- Application Forms
- Project Narrative
- Technical Memorandum
- Wastewater Analysis
- Project Specifications
- Soils Evaluation
- Design Calculations
- Equipment
- Operation and Maintenance Procedures

Ziad Qudwa
Custom Exempt Slaughterhouse On-Site System

Application Forms

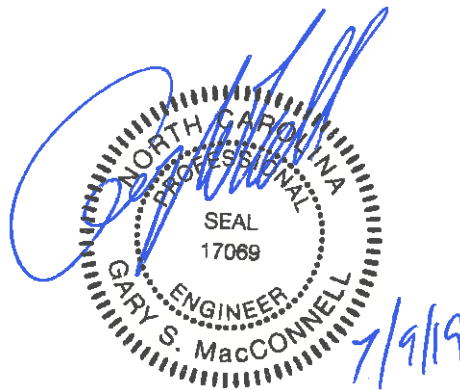

MacConnell & Associates, P.C.
1101 Nowell, Road, Suite 118
Raleigh, North Carolina 27607

P.O. Box 129
Morrisville, North Carolina 27560

Phone: (919) 467-1239
Fax: (919) 319-6510



DEPARTMENT OF HEALTH AND HUMAN SERVICES
DIVISION OF PUBLIC HEALTH

ROY COOPER
GOVERNOR

MANDY COHEN, MD, MPH
SECRETARY

DANIEL STALEY
DIRECTOR

COMMON FORM FOR ENGINEERED OPTION PERMIT
See Instructions for Use in Appendix A

Except for "Date received", this Section to be completed by the Professional Engineer licensed in accordance with G.S. 89C

LHD USE ONLY: Initial submittal of this NOI received: _____ by _____ Date Initials

PART 1: Notice of Intent to Construct (NOI)

- New Expansion
 Repair – LHD Permit Number _____ Repair – EOP Permit Number _____

1. Facility Owner's name: (Owner, Company Name, Utility, Partnership, Individual, etc.): Ziad Qudwa
Qudwa Investments, LLC

Mailing address: 1253 Atkins Road City: Fuquay Varina State: NC Zip: 27526

Telephone number: (919) 412-8944 E-mail Address: qudwa2008@gmail.com

2. Professional Engineer (PE) name: Gary S. MacConnell License number: 17069

Mailing address: 1101 Nowell Rd., Suite 118 City: Raleigh State: NC Zip: 27560

Telephone number: (919) 467-1239 E-mail Address: gsmmacassoc@bellsouth.net

3. Licensed Soil Scientist (LSS) name: Alex Adams License number: 1247

Mailing address: 1676 Mitchell Rd. City: Angier State: NC Zip: 27501

Telephone number: (919)414-6761 E-mail Address: alexadams@bcsoils.com

4. Licensed Geologist (LG) (if applicable) name: _____ License Number: _____

Mailing address: _____ City: _____ State: _____ Zip: _____

Telephone number: _____ E-mail Address: _____

5. On-site Wastewater Contractor name: David Brantley & Sons, Inc. License number: 1036

Mailing address: 37 Pine Ridge Road City: Zebulon State: NC Zip: 27597

Telephone number: (252) 478-3721 E-mail Address: 1installer@gmail.com

6. Proof of Errors and Omissions or other appropriate liability insurance for the following persons is attached that includes the name of the insurer, name of the insured and the effective dates of coverage:

- PE LSS LG On-site Wastewater Contractor

7. Property location (physical address, tax parcel identification number or subdivision lot, block number of the property to be permitted): 1253 Atkins Road

County Name: Harnett County

8. Type of facility: Place of residence No. Bedrooms: _____ No. Occupants: _____
 Place of business Basis for flow calculation: 50gal/100SF market floor/day, 25gal/employee/day
 Place of public assembly Basis for flow calculation: _____

9. Factors that would affect the wastewater load: Species of live stock , Number of animals killed per day
Day of the week

10. Type, location, and classification (per Rule .1961) of wastewater system: Type V; located in left rear of property as viewed from road; pressure manifold with E-Z Treat

11. Design wastewater flow: 615 gpd (For flow > 3,000 gpd and industrial process, duplicate plans shall be sent to the State.)
Design wastewater strength: domestic high strength industrial process

12. A plat as defined in G.S. 130A 334(7a) is attached: Yes No

13. Owner meets requirements of ownership or control of the system per 15A NCAC 18A .1938(j): Yes No

14. Easement, right of way or encroachment agreement required per 15A NCAC 18A .1938(j): Yes No
If yes, documentation filed in _____ County Register of Deeds in Deed book _____ Page _____

15. Multi-party agreements required, as applicable, pursuant to 15A NCAC 18A .1937(h): Yes No
If yes, agreements filed in _____ County Register of Deeds in Deed book _____ Page _____

16. Location of proposed or existing wells (drinking water, irrigation, geothermal, groundwater monitoring, sampling, etc.) and any potable and non-potable water conveyance lines is indicated on attached plans and complies with 15A NCAC 18A .1950: Yes No

This is a saprolite system. Yes No

17. Evaluation(s) of soil conditions and site features in accordance with G.S. 130A-335(a1) signed and sealed by a LSS is attached: Yes No

18. Evaluation of geologic and hydrogeologic conditions signed and sealed by a LG is attached Yes NA

19. Proposed landscape, site, drainage, or soil modifications are attached: Yes NA

Attestation by Professional Engineer licensed in North Carolina pursuant to G.S. 89C

I, Gary S. MacConnell hereby attest that the information required to be included with
Registered Professional Engineer (Print Name)

this Notice of Intent to Construct is accurate and complete to the best of my knowledge and that the proposed system shall meet applicable federal, State, and local laws, regulations, rules and ordinances in accordance with G.S. 130A-336-.1(e)(6).

Gary S. MacConnell 1/9/19
Signature of Licensed Professional Engineer *Date*

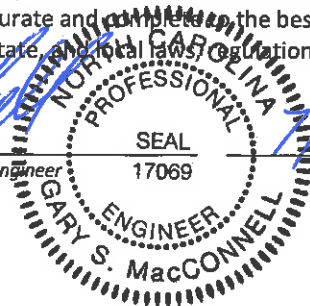

This section is for Owner use to either designate PE as their legal representative or to self-submit the NOI.

Designation of Registered Professional Engineer as legal representative of Owner for this Notice of Intent:

I, Ziad Quidwa hereby designate Gary S. MacConnell
Print Name of Owner Print Name of Registered Professional Engineer

is my legal representative for purposes of this Notice of Intent pursuant to G.S. 130A-336.1.

Ziad Quidwa 7/9/19
Signature of Owner Date

Owner self-submittal of NOI:

I, _____ hereby submit this NOI prepared by _____
Print Name of Owner Print Name of Licensed PE

pursuant to G.S. 130A-336.1.

Signature of Owner Date

NOTES:
LIABILITY: *The Department, the Department's authorized agents or local health departments shall have no liability for wastewater systems designed, constructed and installed pursuant to an Engineered Option Permit. [(NC General Statute 130A-336.1(f))]*

RIGHT OF ENTRY: *The submittal of this Notice of Intent to Construct grants right of entry to the Local Health Department and the State to the referenced property.*

ISSUANCE OF BUILDING PERMIT: *Once the LHD deems that the Notice of Intent to Construct is complete via signature in the section above, the owner may apply to the local permitting agency for a permit for electrical, plumbing, heating, air conditioning or other construction, location or relocation activity under any provision of general or special law pursuant to G.S. 130A-338.*

This section for Local Health Department use only.

PART 2: LHD Completeness Review of the Notice of Intent to Construct

“(c) Completeness Review for Notice of Intent to Construct. – The local health department shall determine whether a notice of intent to construct, as required pursuant subsection (b) of this section, is complete within 15 business days after the local health department receives the notice of intent to construct. A determination of completeness means that the notice of intent to construct includes all of the required components. If the local health department determines that the notice of intent to construct is incomplete, the department shall notify the owner or the professional engineer of the components needed to complete the notice. The owner or professional engineer may submit additional information to the department to cure the deficiencies in the notice. The local health department shall make a final determination as to whether the notice of intent to construct is complete within 10 business days after the department receives the additional information from the owner or professional engineer. If the department fails to act within any time period set out in this subsection, the owner or professional engineer may treat the failure to act as a determination of completeness.”

The review for completeness of this Notice of Intent was conducted in accordance with G.S. 130A-336.1(c). This NOI is determined to be:

INCOMPLETE (If box is checked, Information in this section is required.)

Based upon review of information submitted by the PE in Part 1, the following items are missing: _____

Copies of this form listing missing items were sent to the design PE and the Owner on _____

via _____ with directions to re-submit missing items using Page 5 of this form.
Date
Email, FAX, USPS, hand-delivered

Print Name of Authorized Agent of the LHD *Signature of Authorized Agent of the LHD* *Date*

COMPLETE (If box is checked, information in this section is required.)

Based upon review of information submitted by the PE in Part 1 of this form, this NOI is deemed COMPLETE.

Copies of this signed form were sent to the design PE and the Owner on _____ via _____.
Date *Email, FAX, USPS, hand-delivered*

A copy of this NOI and tracking information was sent to the State on _____ via _____.
Date *Email, FAX, USPS, hand-delivered*

Print Name of Authorized Agent of the LHD *Signature of Authorized Agent of the LHD* *Date*

PART 3: Authorization to Operate (ATO)

Except for date received, the Section below is to be completed by the Owner or by the PE designated to act as their legal representative for the EOP.

LHD USE ONLY: Initial submittal of request for ATO received: _____ by _____ <div style="display: flex; justify-content: space-around; font-size: small;"> Date Initials </div>
Date of Post-construction Conference: _____

The following items are included in this submittal for an Authorization to Operate under an EOP:

- | | | |
|--|------------------------------|-----------------------------|
| 1. Signed and sealed copy of the Engineer's report that includes: | | |
| a. Signed and sealed evaluation of soil conditions and site features | <input type="checkbox"/> Yes | <input type="checkbox"/> No |
| b. Drawings, specifications, plans | <input type="checkbox"/> Yes | <input type="checkbox"/> No |
| c. Reports on special inspections and final inspection | <input type="checkbox"/> Yes | <input type="checkbox"/> No |
| d. Management Program manual | <input type="checkbox"/> Yes | <input type="checkbox"/> No |
| e. On-site Wastewater Contractor's signed statement | <input type="checkbox"/> Yes | <input type="checkbox"/> No |
| f. Signed and sealed statement pursuant to 15A NCAC 18A .1938(h) | <input type="checkbox"/> Yes | <input type="checkbox"/> No |
| 2. Fee (as applicable) | <input type="checkbox"/> Yes | <input type="checkbox"/> No |
| 3. Notarized letter documenting Owner's acceptance of the system from the PE | <input type="checkbox"/> Yes | <input type="checkbox"/> No |

Attestation by the Owner or the PE for Authorization to Operate

I, _____ hereby attest that all items indicated above have been provided to the
Print name of Owner or Professional Engineer

_____ County LHD and the system shall meet applicable federal, State, and local laws, regulations, rules and ordinances in accordance with G.S. 130A-336-.1(e)(6).

<i>Signature of Owner or Professional Engineer</i>	<i>Date</i>
--	-------------

This section for LHD Use Only.

LHD Review of required information for the ATO

INCOMPLETE
 Based upon review of information submitted by the Owner or PE in the Section above, the following items are missing from the information required for an Authorization to Operate for an EOP: _____

Copies of this signed form were sent to the design PE and the Owner on _____ via _____
DateEmail, FAX, USPS, Hand-delivered

<i>Print name of authorized Agent of the LHD</i>	<i>Signature of authorized Agent of the LHD</i>	<i>Date</i>
--	---	-------------

COMPLETE
 Based upon review of information submitted by the Owner or PE in the Section above, this Authorization to Operate is hereby issued in accordance with G.S. 130A-336.1(m).

A copy of this complete NOI/ATO with tracking information was sent to the State on _____ via _____
DateEmail, FAX, USPS, Hand-delivered

<i>Print name of authorized Agent of the LHD</i>	<i>Signature of authorized Agent of the LHD</i>	<i>Date</i>
--	---	-------------

ISSUANCE OF CERTIFICATE OF OCCUPANCY: Once the LHD determines completeness based upon the PE submission, the owner may apply to the local permitting agency for permanent electrical service to a residence, place of business or place of public assembly pursuant to G.S. 130A-339.



MACCO-1

OP ID: CH

CERTIFICATE OF LIABILITY INSURANCE

DATE (MM/DD/YYYY)
04/26/2019

THIS CERTIFICATE IS ISSUED AS A MATTER OF INFORMATION ONLY AND CONFERS NO RIGHTS UPON THE CERTIFICATE HOLDER. THIS CERTIFICATE DOES NOT AFFIRMATIVELY OR NEGATIVELY AMEND, EXTEND OR ALTER THE COVERAGE AFFORDED BY THE POLICIES BELOW. THIS CERTIFICATE OF INSURANCE DOES NOT CONSTITUTE A CONTRACT BETWEEN THE ISSUING INSURER(S), AUTHORIZED REPRESENTATIVE OR PRODUCER, AND THE CERTIFICATE HOLDER.

IMPORTANT: If the certificate holder is an ADDITIONAL INSURED, the policy(ies) must have ADDITIONAL INSURED provisions or be endorsed. If SUBROGATION IS WAIVED, subject to the terms and conditions of the policy, certain policies may require an endorsement. A statement on this certificate does not confer rights to the certificate holder in lieu of such endorsement(s).

PRODUCER The Adcock Agency, Inc. 215 E. Chatham St. Suite 120 Cary, NC 27511 John W. Miller, Jr., CPCU,CIC	919-467-8126	CONTACT NAME: John W. Miller, Jr., CPCU,CIC
		PHONE (A/C, No, Ext): 919-467-8126 FAX (A/C, No): 919-467-8175
		E-MAIL ADDRESS: jtmiller@adcockagency.com
INSURER(S) AFFORDING COVERAGE		NAIC #
INSURER A:	ERIE Insurance Exchange	26271
INSURER B:	Continental Casualty Co (CNA)	
INSURER C:		
INSURER D:		
INSURER E:		
INSURER F:		

INSURED **Macconnell & Associates Pc**
PO Box 129
Morrisville, NC 27560-0129

COVERAGES CERTIFICATE NUMBER: REVISION NUMBER:

THIS IS TO CERTIFY THAT THE POLICIES OF INSURANCE LISTED BELOW HAVE BEEN ISSUED TO THE INSURED NAMED ABOVE FOR THE POLICY PERIOD INDICATED. NOTWITHSTANDING ANY REQUIREMENT, TERM OR CONDITION OF ANY CONTRACT OR OTHER DOCUMENT WITH RESPECT TO WHICH THIS CERTIFICATE MAY BE ISSUED OR MAY PERTAIN, THE INSURANCE AFFORDED BY THE POLICIES DESCRIBED HEREIN IS SUBJECT TO ALL THE TERMS, EXCLUSIONS AND CONDITIONS OF SUCH POLICIES. LIMITS SHOWN MAY HAVE BEEN REDUCED BY PAID CLAIMS.

INSR LTR	TYPE OF INSURANCE	ADDL INSD	SUBR WVD	POLICY NUMBER	POLICY EFF (MM/DD/YYYY)	POLICY EXP (MM/DD/YYYY)	LIMITS
A	<input checked="" type="checkbox"/> COMMERCIAL GENERAL LIABILITY <input type="checkbox"/> CLAIMS-MADE <input checked="" type="checkbox"/> OCCUR			Q97-0842712	11/04/2018	11/04/2019	EACH OCCURRENCE \$ 1,000,000 DAMAGE TO RENTED PREMISES (Ea occurrence) \$ 1,000,000 MED EXP (Any one person) \$ 5,000 PERSONAL & ADV INJURY \$ 1,000,000 GENERAL AGGREGATE \$ 2,000,000 PRODUCTS - COM/PROP AGG \$ 2,000,000
	GEN'L AGGREGATE LIMIT APPLIES PER: <input type="checkbox"/> POLICY <input type="checkbox"/> PRO-JECT <input type="checkbox"/> LOC OTHER						
	AUTOMOBILE LIABILITY <input type="checkbox"/> ANY AUTO OWNED AUTOS ONLY <input type="checkbox"/> HIRED AUTOS ONLY <input type="checkbox"/> SCHEDULED AUTOS <input type="checkbox"/> NON-OWNED AUTOS ONLY						COMBINED SINGLE LIMIT (Ea accident) \$ BODILY INJURY (Per person) \$ BODILY INJURY (Per accident) \$ PROPERTY DAMAGE (Per accident) \$
A	<input type="checkbox"/> UMBRELLA LIAB <input checked="" type="checkbox"/> EXCESS LIAB DED <input checked="" type="checkbox"/> RETENTION \$ 10000			Q31-1070288	07/10/2018	07/10/2019	EACH OCCURRENCE \$ 2,000,000 AGGREGATE \$ 2,000,000
A	WORKERS COMPENSATION AND EMPLOYERS' LIABILITY ANY PROPRIETOR/PARTNER/EXECUTIVE OFFICER/MEMBER EXCLUDED? (Mandatory in NH) <input type="checkbox"/> Y/N If yes, describe under DESCRIPTION OF OPERATIONS below		N/A	Q91-1000820	07/10/2018	07/10/2019	<input checked="" type="checkbox"/> PER STATUTE <input type="checkbox"/> OTH-ER E.L. EACH ACCIDENT \$ 1,000,000 E.L. DISEASE - EA EMPLOYEE \$ 1,000,000 E.L. DISEASE - POLICY LIMIT \$ 1,000,000
B	E&O			AEH591893132	09/17/2018	09/17/2019	E&O 1,000,000

DESCRIPTION OF OPERATIONS / LOCATIONS / VEHICLES (ACORD 101, Additional Remarks Schedule, may be attached if more space is required)
ENGINEER; Policy forms and endorsements apply; FOR PROPOSAL USE ONLY

CERTIFICATE HOLDER	CANCELLATION
THIS CER	SHOULD ANY OF THE ABOVE DESCRIBED POLICIES BE CANCELLED BEFORE THE EXPIRATION DATE THEREOF, NOTICE WILL BE DELIVERED IN ACCORDANCE WITH THE POLICY PROVISIONS.
This Certificate is for Informational Purposes Only. Certificate Holder Name and Address Needed to Validate.	AUTHORIZED REPRESENTATIVE <i>Christal D Ham</i>

CERTIFICATE OF LIABILITY INSURANCE

THIS CERTIFICATE IS ISSUED AS A MATTER OF INFORMATION ONLY AND CONFERS NO RIGHTS UPON THE CERTIFICATE HOLDER. THIS CERTIFICATE DOES NOT AFFIRMATIVELY OR NEGATIVELY AMEND, EXTEND OR ALTER THE COVERAGE AFFORDED BY THE POLICIES BELOW. THIS CERTIFICATE OF INSURANCE DOES NOT CONSTITUTE A CONTRACT BETWEEN THE ISSUING INSURER(S), AUTHORIZED REPRESENTATIVE OR PRODUCER, AND THE CERTIFICATE HOLDER.

IMPORTANT: If the certificate holder is an ADDITIONAL INSURED, the policy(ies) must be endorsed. If SUBROGATION IS WAIVED, subject to the terms and conditions of the policy, certain policies may require an endorsement. A statement on this certificate does not confer rights to the certificate holder in lieu of such endorsement(s).

INSURED ALEX ANDREW ADAMS
 NAME AND 1676 MITCHELL RD
 ADDRESS ANGIER NC 27501

CERTIFICATE MACCONNELL & ASSOCIATES P.C.
 HOLDER PO BOX 129
 MORRISVILLE NC 27560

COVERAGES

THIS IS TO CERTIFY THAT THE POLICIES OF INSURANCE LISTED BELOW HAVE BEEN ISSUED TO THE INSURED NAMED ABOVE FOR THE POLICY PERIOD INDICATED. NOTWITHSTANDING ANY REQUIREMENT, TERM OR CONDITION OF ANY CONTRACT OR OTHER DOCUMENT WITH RESPECT TO WHICH THIS CERTIFICATE MAY BE ISSUED OR MAY PERTAIN, THE INSURANCE AFFORDED BY THE POLICIES DESCRIBED HEREIN IS SUBJECT TO ALL THE TERMS, EXCLUSIONS AND CONDITIONS OF SUCH POLICIES. LIMITS SHOWN MAY HAVE BEEN REDUCED BY PAID CLAIMS.

X	TYPE OF INSURANCE	ADDL INSD	SUBR WVD	POLICY NUMBER	POLICY EFF (MM/DD/YYYY)	POLICY EXP (MM/DD/YYYY)	LIMITS	
X	COMMERCIAL GENERAL LIABILITY - OCCURRENCE GEN'L AGGREGATE APPLIES PER POLICY			GL 0524143	9/14/2018	9/14/2019	GENERAL AGGREGATE	\$2,000,000
							PRODUCTS - COMP/OPS AGGREGATE	\$2,000,000
							PERSONAL & ADV INJURY	\$1,000,000
							EACH OCCURRENCE	\$1,000,000
							DAMAGE TO RENTED PREMISES (Ea Occurrence)	\$100,000
							MED EXP (Any one person)	\$5,000
	BUSINESSOWNERS						EACH OCCURRENCE	\$
							AGGREGATE	\$
	AUTOMOBILE LIABILITY						COMBINED SINGLE LIMIT (Each accident)	\$
	SCHEDULED AUTOS						BODILY INJURY (Per person)	\$
	HIRED AUTOS						BODILY INJURY (Per accident)	\$
	NON-OWNED AUTOS						PROPERTY DAMAGE (Per accident)	\$
	GARAGE LIABILITY							
	_____ (Other)							
	EXCESS LIABILITY - OCCURRENCE						EACH OCCURRENCE	\$
							AGGREGATE	\$
X	WORKERS COMPENSATION AND EMPLOYERS' LIABILITY POLICY APPLIES TO THE WORKERS COMPENSATION LAW IN THE STATE OF NC	N/A		WC 0253797	4/1/2019	10/11/2019	WC STATUTORY LIMITS	
							E.L. EACH ACCIDENT	\$1,000,000
							E.L. DISEASE - EA EMPLOYEE	\$1,000,000
							E.L. DISEASE - POLICY LIMIT	\$1,000,000
	OTHER:							

DESCRIPTION OF OPERATIONS / LOCATIONS / VEHICLES:

CANCELLATION
 SHOULD ANY OF THE ABOVE DESCRIBED POLICIES BE CANCELLED BEFORE THE EXPIRATION DATE THEREOF, NOTICE WILL BE DELIVERED IN ACCORDANCE WITH THE POLICY PROVISIONS.

AUTHORIZED REPRESENTATIVE
L.M. Squires
 DATE MAY 16, 2019

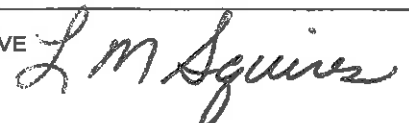

LEGEND

- CMS - CONCRETE CONUMENT SET
- ECM - EXISTING CONCRETE MONUMENT
- EPK - EXISTING EPOXY PIPE
- ES - EXISTING IRON STAKE
- ERB - EXISTING REBAR
- ECS - EXISTING COTTON SPIKE
- EPA - EXISTING PPK NAIL
- EN - EXISTING NAIL
- ERS - EXISTING RAILROAD SPIKE
- IPS - IRON PIPE SET
- ISS - IRON STAKE SET
- RSS - RAILROAD SPIKE SET
- NS - NAIL SET
- PKS - PPK OR NAG. NAIL SET
- R/W - RIGHT OF WAY
- CL - CENTERLINE
- B.M. - BOOK OF MAPS
- P.B. - PLAT BOOK
- M.B. - MAP BOOK
- D.B. - DEED BOOK
- SS - SET BACK
- EP - EDGE PAVEMENT
- BC - BACK OF CURB
- MH - MANHOLE
- ELEV - ELEVATION
- UP - UTILITY POLE
- TP - TELEPHONE PEDESTAL
- C/O - SEWER CLEAN OUT
- WV - WATER VALVE
- WM - WATER METER
- HYD - FIRE HYDRANT
- T - TELEPHONE
- E - ELECTRIC
- W - WATER
- S - SANITARY SEWER
- G - GAS LINE
- D - DRAINAGE

THE DIVISION OF PROPERTY IS
 DERIVED FROM THE HARNETT COUNTY
 SUBDIVISION REGULATION

Thompson 3/11
 PLANNING DIRECTOR DATE

CERTIFICATE OF OWNERSHIP, DESIGNATION AND JURISDICTION

I (WE) HEREBY CERTIFY THAT I AM (ARE) THE OWNER(S) OR
 AGENT OF THE PROPERTY SHOWN AND DESCRIBED HEREIN AND THAT
 I (WE) HEREBY ADOPT THIS PLAN OF SUBDIVISION WITH ALL (OUR)
 FREE CONSENT, ESTABLISH THE NECESSARY BUILDING SETBACK LINES
 AND DESIGNATE ALL STREETS, ALLEYS, WALKS, PARKS AND OTHER
 SITES AND EASEMENTS TO PUBLIC OR PRIVATE USE AS NOTED, ALL
 OF THE LAND SHOWN HEREIN IS WITHIN THE SUBDIVISION REGULATION
 JURISDICTION OF HARNETT COUNTY EXCEPT:

3-1-11 1996L
 (2007)

TAX PARCEL I.D. NUMBER
 OWNER
 OFFICER

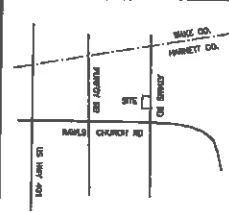

COURSE	BEARING	DISTANCE
L-1	S 79°40'50"E	11.15'
L-2	N 43°47'42"E	21.00'
L-3	N 70°41'15"E	78.82'
L-4	N 84°18'20"E	65.82'
L-5	N 78°08'56"E	27.21'
L-6	S 80°12'33"E	38.13'
L-7	S 89°12'30"E	52.72'
L-8	S 87°15'50"E	100.28'
L-9	S 86°17'18"E	68.85'
L-10	N 88°50'08"E	30.80'
L-11	S 71°13'04"W	70.31'
L-12	S 78°35'12"W	70.81'
L-13	S 87°51'23"W	94.85'
L-14	N 86°28'52"W	78.10'
L-15	N 80°16'33"W	121.37'
L-16	N 78°07'28"W	88.28'
L-17	N 07°51'23"W	85.88'
L-18	N 85°46'28"W	89.20'
L-19	N 01°53'24"W	184.88'
L-20	N 48°27'49"E	78.85'
L-21	N 40°58'06"W	153.65'

NOTES
 AREA BY COORDINATES
 NO NCOS CONTROL FOUND WITHIN 2000'
 PROPERTY SUBJECT TO ABOVE AND/OR BELOW GROUND
 UTILITIES AND/OR EASEMENTS.
 THIS PROPERTY IS NOT LOCATED IN A
 FLOOD HAZARD AREA PER
 F.E.M.A. MAP #270054001
 EFF. DATE: 10/3/2008 ZONE X

REFERENCES

- D.B. 1354 PG. 446
- D.B. 1943 PG. 828
- MAP #2004-786
- MAP #2007-885
- OTHERS AS SHOWN

ZONING

ZONED RA-40

SETBACKS

- FRONT - 35'
- REAR - 25'
- SIDE - 10'
- CORNER SIDE - 20'

GREGORY FAMILY TRUST
 D.B. 2077 PG. 145

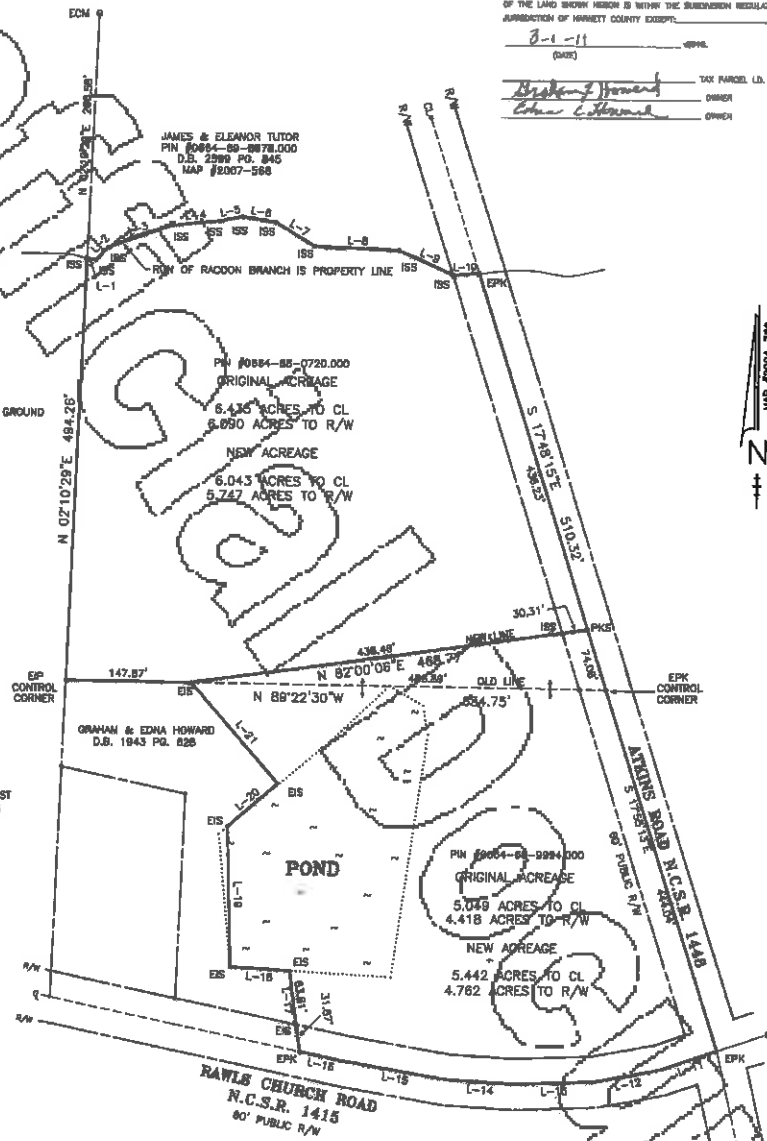

REVIEW OFFICER'S CERTIFICATE

STATE OF North Carolina
 COUNTY OF Harnett
 I, Vali H. Dixon, REVIEW OFFICER OF Harnett COUNTY,
 CERTIFY THAT THE MAP OR PLAN TO WHICH THIS CERTIFICATION
 IS AFFIXED MEETS ALL STATUTORY REQUIREMENTS FOR RECORDING.
 REVIEW OFFICER
Vali H. Dixon
 DATE
3-1-11



FOR REGISTRATION REGISTERED OF DEEDS
 HARNETT COUNTY, NC
 2011 FEB 01 02:04:12 PM
 BK:2011 PG:95-96 FEE:\$21.90
 INSTRUMENT # 2011083085

RECOMMINATION SURVEY FOR:
GRAHAM F. HOWARD, SR. & EDNA C. HOWARD
 PIN #0864-88-0720.000
 DEED BOOK 1556 PAGE 449
 PIN #0864-88-0994.000
 DEED BOOK 1043 PAGE 828
 MAP #2004-786

BLACK RIVER TOWNSHIP
 HARNETT COUNTY, NORTH CAROLINA
 SCALE: 1" = 100'
 FEBRUARY 28, 2011
 100 0 100 200 300
 GRAPHIC SCALE - FEET

I, Benton W. Dewar, PROFESSIONAL LAND SURVEYOR
 NO. 3040, CERTIFY:
 THAT THIS PLAN IS OF A SURVEY THAT CREATES A
 RECOMMINATION SURVEY OF AN EXISTING PARCEL
 OF LAND THAT IS REGULATED BY COUNTY OR
 MUNICIPALITY ORDINANCES THAT REGULATES PARCELS
 OF LAND.
Benton W. Dewar
 BENTON W. DEWAR, NOPLS - 3040



HARNETT COUNTY
 NORTH CAROLINA
 FILED DATE: March 1, 2011 TIME: 2:24 PM
 MAP NUMBER: 2011-95
 HONORABLE S. HARROVE
 REGISTERED OF DEEDS
 BY: Mary Ann Wood DEPUTY

RECORDED IN MAP #2011-95 HARNETT CO. REG.

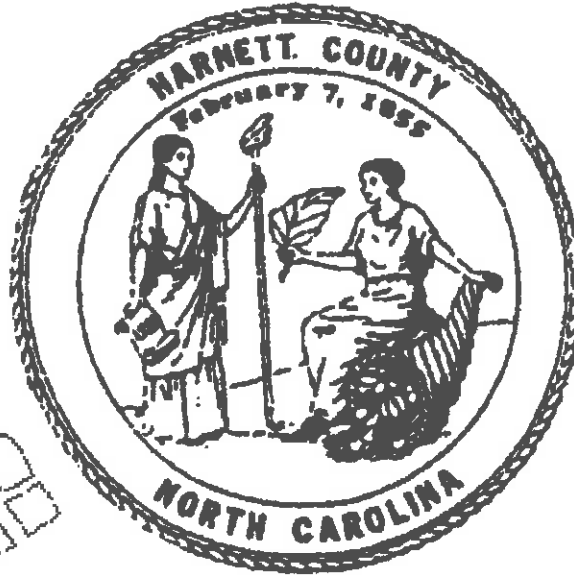

KIMBERLY S. HARGROVE
REGISTER OF DEEDS, HARNETT
305 W CORNELIUS HARNETT BLVD
SUITE 200
LILLINGTON, NC 27546

Filed For Registration: 03/01/2011 02:04:12 PM

Book: PLAT 2011 Page: 95-96

Document No.: 2011003085

MAP 2 PGS \$21.00

Recorder: MARY ANNE WOOD

State of North Carolina, County of Harnett

KIMBERLY S. HARGROVE , REGISTER OF DEEDS

DO NOT DISCARD

2011003085

Ziad Qudwa
Custom Exempt Slaughterhouse On-Site System

Project Narrative



MacConnell & Associates, P.C.
1101 Nowell, Road, Suite 118
Raleigh, North Carolina 27607

P.O. Box 129
Morrisville, North Carolina 27560

Phone: (919) 467-1239

Fax: (919) 319-6510

Project Narrative

Introduction

Ziad Qudwa wishes to construct a custom exempt slaughtering facility at a 5.31 acres farm land located at 1253 Atkins Road in Fuquay Varina, Harnett County, North Carolina with the following: one (1) offices, slaughtering room, and temporary animal keeping room with capacity of 5 employees. Slaughtering events will occur on a daily basis as needed per week. The scope of this project is to design the pressure manifold system utilizing a septic tank, a grease trap tank, equalization tank, a recirculation tank with an E-Z Treat treatment pod, a field dosing tank, and necessary appurtenances based on information provided by the Soils Evaluation prepared by Adams Soil Consulting.

The design proposes a pressure manifold system with one 3,160-gallon septic tank, one 2,000-gallon grease trap tank, one 4,500-gallon equalization tank with one pump to dose the equalized flow, one 1850-gallon recirculation tank with one model 600 E-Z Treat treatment pod, and one 2,000-gallon field dosing tank with one pump to dose treated wastewater to the drain lines to dispose the domestic wastewater of the slaughtering building. The manifold will be located at the east of the property, and the treatment system will be located to the northeast of the property adjacent to the proposed slaughterhouse. The drain field will receive an equalized daily flow with a pre-set dose pump time. The flow and dosing time will be controlled by a demand-dosed control panel.

The proposed wastewater treatment and disposal system does not have any conflicts with existing utilities in the area. The system also maintains all buffer and setback requirements set in the 15A NCAC 18A .1900 rules amended January 1, 1999. The proposed system will meet all the requirements and specifications outlined in NCDEQ's Innovative Wastewater System Approval No. IWWS-2004-01 and Innovative Wastewater System Approval No: IWWS-2015-03-R2.

Septic, E-Z Treat Recirculation, and Field Dosing Tank

The proposed wastewater treatment system will provide both anaerobic treatment and solids removal in the new 3,160-gallon septic tank. This tank will provide greater than 48 hours of detention providing for adequate anaerobic treatment and solids removal from the wastewater. Septic tank effluent will drain into the grease trap tank as wastewater flows into the septic tank. The septic tank will contain a Polylok PL-625, or approved equal effluent filter by engineer to prevent larger solids from reaching the grease trap tank and the E-Z Treat recirculation tank.

The grease trap tank is a new 2,000-gallon grease trap tank. The tank will remove the majority of the fats, oil, and grease (FOG) generated from the slaughter operation. The grease trap tank will contain a Polylok PL-625 or approved equal effluent filter as shown on the construction drawings to prevent fats, oils, grease, and solids from reaching the E-Z Treat recirculation tank.

The flow equalization tank is a new 4,500-gallon pump tank. The equalization tank will be sufficient for peak flows and maximum daily flows generated from upstream. Preset dosages will be dosed daily by an equalization pump to the E-Z Treat recirculation tank.

The E-Z Treat recirculation tank is a new 1,850-gallon pump tank. An effluent bypass valve located in the E-Z Treat recirculation tank will separate the flow once the E-Z Treat treatment unit is dosed. The effluent will be returned to the E-Z Treat recirculation tank until the bypass valve is closed, the remaining effluent will then flow to a field dosing tank. Effluent will be recirculated through the E-Z Treat treatment unit until additional septic tank effluent enters the E-Z Treat recirculation tank causing the bypass valve to close.

The field dosing tank is new 2,000-gallon pump tank. The baffle wall of the tank is optional, and the tank will provide treated effluent to dose the fields.

E-Z Treat Treatment Unit(s)

The Model 600 E-Z Treat treatment unit(s) will be used to provide additional treatment to the septic tank effluent as well as removing any suspended solids not removed by the septic tank. The E-Z Treat treatment unit includes housing, piped distribution system, sprinkler heads, and styrene media. The underdrain system will transport the E-Z Treat treatment unit effluent back through an effluent bypass valve into one of the dosing tanks.

Ultraviolet Disinfection

The effluent from the E-Z Treat recirculation tank will be disinfected by ultraviolet light prior to entering the field dosing tank and being irrigated. The ultraviolet disinfection unit shall be by E-Z Treat UV-101 or approved equal by engineer.

Proposed System Design

Design daily flows and calculations:

Highest Daily Flow:	5 Employees * 25 GPD/Employee + 1,836 GPD (Slaughtering Operation on Saturday) = <u>1,961 GPD</u>
Weekly Total Flow:	<u>4,306 GPW (Please see calculations.)</u>
Equalized Daily Flow:	4,306 GPD / 7 days/week = <u>615 GPD</u>
System Type:	Septic Tank, Grease Trap, Equalization Tank, E-Z Treat Recirculation Tank, E-Z Treat Pod, Field Dosing Tank, Pressure Manifold, and Conventional Corrugated Drain Lines.
Septic Tank Volume:	3,160 Gallons
Grease Trap Volume:	2,000 Gallons

Equalization Tank Volume: 4,500 Gallons
 Recirculation Tank Volume: 1,850 Gallons
 E-Z Treat Pod Capacity: 700 GPD
 Field Dosing Tank Volume: 2,000 Gallons
 Field Dosing Pump Rate: 56.16 GPM at 47.96 Feet Head
 Pump Model: Zoller 188 Series, Model E188, 1-1/2 HP
 Pump Dose Volume: 314 Gallons
 Dose Type: Demand Dosed at ± 3 Times per Day
 Drain Lines: see calculations
 Trench Type: Conventional corrugated drain pipe
 LTAR: 0.40 GPD/SF (0.53 GPD/SF with Innovative Technology)
 Area Required: $\frac{615 \text{ GPD}}{0.40 \text{ GPD/SF}} = 1,538 \text{ SF}$
 (W/ INOV $\frac{615 \text{ GPD}}{0.53 \text{ GPD/SF}} = 1,161 \text{ SF}$)
 Minimum Linear Feet: $\frac{1,538 \text{ SF}}{3 \text{ FT}} = 513 \text{ LF}$
 (W/ INOV $\frac{1,161 \text{ SF}}{3 \text{ FT}} = 387 \text{ LF}$)

Pressure Manifold

The pressure manifold will be as shown on the construction drawings, or approved equal. The forcemain will carry wastewater to the pressure manifold where it will be distributed to the drainfield laterals.

Control Panels

The control panels shall be the Timed and Demand Dosed Simplex Control Panels by SJE Rhombus, or approved equal by engineer. The pump floats will be set at predetermined dose volume have the accurate pump dosage.

EZ Flow Drain Lines

The EZ Flow drain lines will be EZflow 1203H – GEO type. The drain lines shall be installed per manufacturer's recommendations.

Project Contacts

Names, addresses, phone and fax numbers of the owner, soil scientist, and engineer are as follows:

Owner:

Qudwa Investments, LLC
 1253 Atkins Road

Ziad Qudwa Custom Exempt Slaughterhouse
 On-Site System
 MacConnell & Associates, P.C.

Fuquay Varina, North Carolina
Phone (919) 412-8944

Soil Scientist:

Mr. Alex Adams,
Adams Soil Consulting
1676 Mitchell Road
Angier, NC 27501
Phone (919) 414-6761

Engineer:

Mr. Gary S. MacConnell, PE
MacConnell & Associates, P.C.
Physical: 1101 Nowell Road, Suite 118
Raleigh, North Carolina 27607
Mailing: P.O. Box 129
Morrisville, North Carolina 27560
Phone: (919) 467-1239 Cell: (919) 523-2248 Fax: (919) 319-6510

Ziad Qudwa
Custom Exempt Slaughterhouse On-Site System

Technical Memorandum

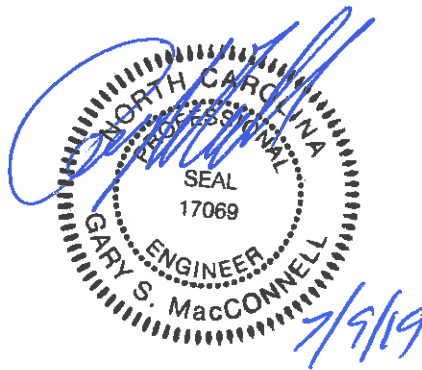

MacConnell & Associates, P.C.
1101 Nowell, Road, Suite 118
Raleigh, North Carolina 27607

P.O. Box 129
Morrisville, North Carolina 27560

Phone: (919) 467-1239
Fax: (919) 319-6510

P. O. Box 129
Morrisville, NC 27560

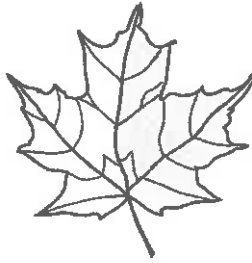

**MACCONNELL
& ASSOCIATES, P.C.**

1101 Nowell Road
Suite 118
Raleigh, NC 27607

Technical Memorandum

To: Ziad Qudwa
From: Gary S. MacConnell, P.E. and Aershen Muheyati
Date: September 27, 2018
Client: Ziad Qudwa
Subject: Custom Exempt Slaughterhouse Cost Analysis
Project No. A67601.00

Introduction

MacConnell & Associates, P.C. (M&A) has been contracted to perform an evaluation of wastewater options for a proposed slaughter house and meat processing facility for Mr. Ziad Qudwa, at 1253 Atkins Road in Harnett County, North Carolina. This memorandum consists of an evaluation of: the existing site conditions, wastewater flow analysis, and cost opinions and recommendations for water supply, wastewater treatment, and disposal systems.

Existing Conditions

The site is located on a 5.3 acre parcel of land with an existing single family residence and several sheds. The current residence is served by county water as well as a private subsurface septic system. A new slaughtering building is proposed at the northern side of the farm. The owner will need to extend water service to the building for potable water supply. Wastewater treatment and disposal systems will also be designed and installed for the slaughterhouse operation as public sewer is not available at the site.

Proposed Business Classification and Type

Per inspection requirements for meat and poultry businesses by North Carolina Department of Agriculture and Consumer Services (NCDA&CS), the slaughtering facility will be considered as a custom exempt facility as the owner only wishes to provide services for slaughtering and processing meat and poultry for the general public for personal consumption only.

A custom exempt facility processes products such as meat, poultry and wild game (deer e.g.) for private individuals only. All products are marked "NOT FOR SALE" and identified by the owner's name. These facilities are inspected for sanitation and proper labeling of products. The meat and poultry products are not inspected for disease or quality and cannot enter commerce. All products must be returned to the original owner for his/her personal use and cannot be sold.

In order to obtain the custom exempt status, the facilities must first meet regulatory performance standards. For example, production rooms constructed of materials impervious to moisture; adequate restrooms, hand wash stations, lighting, ventilation, drainage; equipment and utensils which are cleanable and maintained in sanitary condition, etc. A free analysis can be provided by NCDA&CS. Secondly, an Application for Inspection to NCDA&CS must be completed and submitted. Thirdly, obtain an approved well or public water permit and a wastewater construction authorization permit through local or state environmental health agencies. Lastly, provide the written documents about hours of operation, request to dispose of inedible wastes, chemical list, and safety data sheets.

Flow Analysis

The flow capacity is calculated based on the maximum septic field available, soil conditions and long term acceptance rate (LTAR) provided by Licensed Soil Scientist Alex Adams. The estimated flow is calculated based on both surface and subsurface disposal options. Subsurface is preferred due to the greater setbacks required for spray or drip systems. Surface disposal is regulated by the North Carolina Department of Environmental Quality – Non-Discharge Permitting Unit per Rule 15A NCAC 02T. Per soil scientist Alex Adams, the proposed LTAR will be 0.4 gallons per day (GPD) per square feet (SF). The irrigation field will be located on the Southwest side of the property, yielding about 8,500 square feet (50 feet x 115 feet) conservatively. Therefore, the total maximum flow for this field is 1,275 gallons per day ($0.4 \text{ GPD/SF} * 8,500 \text{ SF} = 1,700 \text{ GPD}$), putting half of the field for future repair as demanded on subsurface codes and regulations. The purpose of the calculation is to determine the maximum proposed floor space for this field.

Please see the attached setback rules 15A NCAC 18A .1950 (Subsurface) and 15A NCAC 02T .0506 (Surface) in Appendix A for setback comparisons.

Depending on the type of wastewater disposal system, the proposed market floor space can vary from 1,533 SF to 2,300 SF (estimated area minus offices, bathrooms, and refrigeration areas) with 5 total full-time employees conservatively. This is a conservative estimate as it is doubtful that there will be 5 full-time employees simultaneously working at the site. The estimated flow is calculated based on both surface and subsurface disposal options. Subsurface is preferred due to the setbacks required for spray or drip systems. Surface disposal is regulated by the North Carolina Department of Environmental Quality - Non-Discharge Permitting Unit per Rule 15A NCAC 02T. Under these regulations 75 gallons per day (GPD) /100 square feet (SF) of market area are used in calculating the flow. Table 1 shows the flow without flow reduction. Please note that flows for

slaughter houses are not provided in the 15A NCAC 02T regulations and this will be discussed later.

Table 1. Projected average daily design flow for systems using surface disposal of wastewater per Rule 15A NCAC 02T.

Meat Market Flow	Daily Average Flow/Unit	Unit	Average Daily Flow
Meat department, butcher shop or fish market	75 Gal/100 SF market floor	+/- 1,533 SF	1,150 GPD
Employees	25 Gal/employee	5 Employees	125 GPD
Total:			1,275 GPD

Sub-surface disposal is regulated by the North Carolina Department of Health and Human Services - Division of Public Health - On-site Water Protection Branch per Rule 15A NCAC 18A. Under these regulations 50 gallons per day (GPD) /100 square feet (SF) of market area are used in calculating the flow. Table 2 shows the flow without flow reduction for subsurface disposal. Flows for slaughter houses are also not provided in the 15A NCAC 18A regulations and will be discussed later.

Table 2. Projected average daily design flow for systems using sub-surface disposal of wastewater per Rule 15A NCAC 18A.

Meat Market Flow	Daily Average Flow/Unit	Unit	Average Daily Flow
Meat department, butcher shop or fish market	50 Gal/100 SF market floor	+/- 2,300 SF	1,150 GPD
Employees	25 Gal/employee	5 Employees	125 GPD
Total:			1,275 GPD

We have summarized the two major factors used to determine the water requirements of the slaughter operation in Table 3. This table provides the number of animals killed per day of operation (as provided by the Client) and the water usage based on EPA design guidelines for meat processing facilities. Per EPA's "Technical Development Document for the Final Effluent Limitations Guidelines and Standards for the Meat and Poultry Products Point Source Category (40 CFR 432)", no value for goat and lamb water usage was found. Since hogs are closer in size to goats and lambs than cattle (hogs used 291 - 442 gallons per 1,000 lbs. and cattle used 532 gallons per 1,000 lbs.), we used 400 gallons per 1,000 lbs. for goats and lambs.

Table 3. Factors used to calculate water usage of the slaughter operation.

Processed Animal Type and Average Weight	Daily Animal Kill	Average Water Usage
Goats (310 lbs./kill)	3 – 4 Live Stock	400 gallons/1,000 lbs.
Lambs (350 lbs./kill)	2 Live Stock	400 gallons/1,000 lbs.

Veal (2,400 lbs./kill)	1 Live Stock	532 gallons /1,000 lbs.
Chicken (3.83 lbs./kill)	15 – 20 Live Stock	2,428 gallons /1,000 lbs.

Table 4 shows a summary of the calculated daily water use for the proposed slaughter operation, based on the factors presented in Table 3. The following calculations also show the peak hour with a peaking factor of 3.

Table 4. Slaughter operation calculated flows.

Live Stock	Weight/Animal (lbs.)	Numbers Processed/Week	Average Water Usage/1,000 lbs.	Average Daily Flow (GPD)	Peak Flow (GPH)
Goats	310	4*7	400	496	186
Lambs	350	2*7	400	280	105
Veal	2,400	1	532	182	479
Chicken	3.83	20*7	2,428	186	70
Average and peak flows				1,144	840

In evaluating the three methods above for calculating flows, we propose a design flow of 1,270 GPD. This is based on the slaughterhouse calculated flow 1,150 GPD plus the worker flow 125 GPD.

Wastewater Analysis

The principle sources of wastewater and wastes are from live stock holding, killing, hair removal, eviscerating, carcass washing, trimming, and general cleanup operations. Wastewater from the slaughter operation is typically considerably higher than domestic strength wastewater. Wastewater from the slaughtering of animals contains organic matter (grease and fats), suspended solids, and inorganic material such as phosphates, nitrates, nitrites, and salts. These materials enter the wastewater treatment system as blood, meat and fatty tissue, meat extracts, paunch content, bedding, manure, hair, dirt, potential contaminated cooling water losses from rendering, curing and pickling solutions, preservatives, and caustic or alkaline detergents. Biochemical oxygen demand (BOD) from blood is high in concentration as well as total suspended solids (TSS), and nitrogen (N). A generalized raw wastewater pollutant summary of slaughterhouse wastewater which was conducted by the United States Environmental Protection Agency (EPA) is shown below in Table 5.

Table 5. Summary of plant and raw waste characteristics for a simple slaughterhouse (EPA).

Base	Flow 1/1000 kg LWK	Kill 1000 LWK/day	BOD5 kg/1000 kg LWK	Suspended solids kg/1000 kg LWK	Grease kg/1000 kg LWK	Kjeldahl Nitrogen as N kg/1000 kg LWK	Chlorides as Cl kg/1000 kg LWK	Total Phosphorus as P kg/1000 kg LWK
Facilities Studied	24	24	24	22	12	5	3	5
Average	5,328	220	6.0	5.6	2.1	0.68	2.6	0.05

Std. Dev.	3,644	135	3.0	3.1	2.2	0.46	2.7	0.03
Range	1,334-14,641	18.5-552	1.5-14.3	0.6-12.9	0.24-7.0	0.23-1.36	0.01-5.4	0.014-0.086

Based on the information presented in Table 5 and other sources of slaughterhouse wastewater pollutant concentrations, we recommend the wastewater characterization of the proposed slaughterhouse as presented in Table 6.

Table 6. Proposed slaughterhouse wastewater characteristics.

Major Contaminants	Concentration (mg/L)
BOD5	1,273
Suspended Solids	1,188
Grease	446
Kjeldahl Nitrogen (N)	144
Chlorides (Cl)	552
Phosphorus (P)	11

Blood is a valuable product and should be collected and not introduced into the waste stream. It may be collected: for a food source, for rendering, dried and used for fertilizer, or for composting. This also helps to keep high strength pollutants (BOD, etc.) out of the wastewater system. The pH of the wastewater may vary because of inclusion of detergent, blood and other contaminations. However, the pH is to be maintained in between 6 to 9 at all times.

Slaughterhouse Building

The slaughterhouse will be built per USDA and NCDA&CS guidelines as well as other lawful authority agencies. Generally, lairage is sized to hold the expected daily kill. This will allow stock to be held overnight before slaughter. We recommend that a greater capacity be provided. However, the holding of stock at the abattoir for an extended period before slaughter should not be permitted. Lairage areas for each specific abattoir should therefore be assessed relative to expected throughput. The area required as a rule of thumb is usually 18 SF per head per cattle and 2.7 SF per head per goat, and 3.8 SF per head per sheep. The size will be determined by the owner, and the pens used to hold species can have one specie per pen or a mixture of two species per pen. Truck access to this area shall be considered. The pens will be divided into sections by fences. In areas where animals, particularly cattle, are normally tethered, a larger area without dividing fences may be preferred to allow tethering rather than penning of animals. The cooler should have a holding capacity of approximately 661 pounds and a chilling capacity of 331 pounds/day shall be provided. In this size range the use of a prefabricated unit has the advantage that complete assembly and testing before leaving the factory is possible. Also a factory built and tested unit will generally be the lowest in cost as skilled on-site work is minimized. The locations of tripe room, meat cutting tables and processing area will be determined by the owner and as a floor plan is proposed.

The new building costs can vary greatly based on size, type of construction, and amenities of the structure. Cost for a basic pre-engineered metal building installed on a concrete foundation runs about \$20.00/S.F. This does not include any internal upfit (bathrooms, plumbing, electrical, furnishings, and equipment). These items are highly variable based on your needs and wants. A basic 40 ft. by 60 ft. structure would be about \$48,000 constructed on site. This is exclusive of any upfit and equipment.

Potential Water Supply Options & Funding

There is a nearby public water service to the site, and the connection is located along Atkins Road on the Eastern side of the proposed building. To request an installation of a water service for a commercial business, Harnett County Department of Public Utilities shall be contacted at 910-893-7575 for required fees. Once the fees are established for the commercial services, application will need to be made at the Public Utilities office at 700 McKinney Parkway in Lillington. It is required to obtain a permit from the Central Permitting office of Harnett County.

Another option is constructing a private well to serve the slaughterhouse at the current site. The construction of the well will not require a permit from the Regional Office under North Carolina Division of Water Resources because the water usage will be under 100,000 gallons per day. The Public Water Resources will not have additional requirements for the well since the proposed number of employees will be under 25. However, a well permit from Harnett County Environmental Health Department will be required. Since public water is available at a reasonable distance to the site, we do not recommend a well construction because there will be further potential costs for water monitoring and well maintenance.

Collection, Treatment & Disposal Options & Costs

Collection: Blood & Waste Disposal

Blood is a valuable source of protein. However, a by-products plant to produce blood meal is not viable at this scale. Blood should not be diverted down the floor drains or sinks of the building since it will quickly clog up the screens and disposal trenches. By using the following treatments blood may be incorporated into stockfeed per the owner's preference. Fresh blood can be directly incorporated into bran, cassava or other stock food where poultry are kept nearby. This represents the simplest and most efficient means of disposal. With this method, it is essential that the resulting meal be fed to the chickens the same day, as it will spoil. When a somewhat longer life for the feed is required, approximately 1% of unslaked (burnt) lime can be added to the blood container and stirred in as the fresh blood is added. The hardened product will keep for up to one week. Lime treated blood can be used similarly as fresh blood. When it is not possible to directly add fresh blood to poultry feed, it may be mixed with bran or cassava after drying. The blood may be dried in the sun on either a concrete floor or matting. Drying will generally be complete in three days. However, the drying area needs to be completely covered to protect it from rain. During rainy periods it would be necessary to dry the mixture on corrugated iron trays placed over a copra dryer or similar fire. Because of the additional cost of drying using this method, we do not recommend on-site blood drying due to its higher cost of design, installation, and operation for the small scale meat processing facility.

It is highly recommended to collect the blood when draining the blood from livestock in order to distress the treatment system from having extremely high BOD, FOG, nitrogen, phosphorus concentrations in the wastewater. Therefore, blood may be stored per renderer's requirements with other byproducts to be collected. Generally, wastes like dry paunch, blood, animal bones, meat extracts, fats and tissues are recycled by renderers for use as animal feeds and fertilizers. The pickup of wastes and rendering process may be provided by Valley Proteins, Inc. Please contact the regional representative, Mr. Van Kloempken, at (919) 995-8376 or email him at VKloempken@valleyproteins.com for detailed rendering procedures, requirements, costs and frequency of pickup services.

Another method is to collect and dispose wastes offsite periodically. The waste storage area shall be kept away from potential contact with the byproducts and meat. Consideration should be given in finding a source for the animal hides.

Treatment & Dispersal:

The residence onsite is not connected to a public sewer system. The house operates under its own on-site wastewater treatment and subsurface dispersal system. There is no sewer line nearby according to Harnett County GIS record. Thus, a private wastewater system is desirable and more cost effective.

The proposed on-site wastewater treatment and dispersal system consists of a solids interceptor, a grease trap tank, pH adjustment and coagulant rapid mixing basin, a settling tank with anaerobic treatment, conventional subsurface drainage lines, and necessary appurtenances. To reiterate, rendering service is required for collection of slaughtering byproducts such as animal skin, bones, meat extracts, paunch, and (possibly) blood. These byproducts shall be prevented from entering the treatment system. As much as possible, all animal slaughtering wastes shall be kept from entering into the on-site system, and they should be collected in designated areas for collection and offsite disposal.

Since the slaughterhouse operation will be on a much smaller than large scale than traditional commercial meat processing facilities, an alternative to conventional screening equipment is a solid interceptor by Striem (model AA-XL, see Appendix B) with screening openings less than 0.1 inches. This will ensure that hair, feathers, meat chunks, animal tissue, and other wastes which were unintentionally drained are screened. This simple device will greatly reduce concentrations of BOD, TSS, FOG and other pollutants from the wastewater. The cost of this tank is \$4,600. The installation and maintenance cost of the interceptor is relatively low due to its "do it yourself" style maintenance, light weight, and ease of installation. Other solids interceptors may also be used.

The solid interceptor effluent flows into a grease trap basin to collect excess fat, oil and grease (FOG) which is in suspension, and which passes through the solids interceptor. FOG are one of the main concerns in the meat processing business. Conventionally, a skimmer and a scraper are used to separate FOG and TSS. This may be part of a dissolved air flotation thickener (DAF). The skimmer collects the floatable solids including FOG on the surface, and the scraper directs the heavier settleable wastes into a hopper. The byproduct from the hopper may be rendered. The

detention time for the basin is usually 20 to 40 minutes at a minimum. However, we propose a grease trap basin only due to the relatively small slaughtering volume. As a rule of thumb, the volume of the basin is typically 1 peak hour with 30 to 40 minutes of detention time. At a minimum, 80% to 90% FOG shall be designed to be removed from this process. The calculated hourly peak flow of the system is 840 GPH (14 GPM). Theoretically, a 50 GPM rated grease interceptor (Model GB-50 by SCHIER) should be sufficient to handle the waste flow. However, it is highly recommended to upsize the grease interceptor to model GB-250 by SCHIER or equal concrete unit for variability of upstream production, less grease tank maintenance frequency, and allowance for future growth. Model GB-250 costs \$5,534 USD whereas model GB-50 costs \$1,872 USD.

A concrete or steel tank, depending on the preference of the owner, may be used as an alternative. Concrete tanks require less maintenance, however, they are typically larger than steel tanks. Although more costly than concrete tanks, the HDPE tank is less expensive than a steel tank and it can be installed above or below ground for the recommended models. The ease of installation and maintenance will lower the total cost of the investment.

Conventionally, a dissolved air flotation tank, also known as DAF, is used to remove suspended solids after screening. The advantage of a DAF is its capability of removing small or light particles more completely and in a shorter time frame. The liquid is compressed with air and a polymer, and the micro bubbles bring the waste to the surface. A skimmer is used to remove the floatable solids. The DAF is usually sized at its optimum depth between 4 to 9 feet depending on the flow generated. However, we deem it is not feasible to use a DAF for the following two reasons. One, for the peak flow and average daily flow, we sized a DAF from HydroFloTech (Model HF005) which would cost \$23,450 dollars per unit according to the manufacturer. The cost is substantial for a small private business owner. Secondly, a DAF requires more consistent flow to effectively remove the TSS from wastewater, whereas the flow from the plant is not constant or substantial. The plant will likely generate some wastewater in the mornings and later in the afternoons and use less or none when customers are not present.

Considering the relatively small-scale production in conjunction with the oversized catch basin and the grease interceptor, we do not consider the DAF applicable for this operation. Following the solids interceptor and grease trap, wastewater will be treated anaerobically in a larger sedimentation/septic tank. The anaerobic treatment is highly applicable because anaerobic treatment is typically used for BOD level between 250 mg/l to up to 10,000 mg/l and the plant will generate high BOD concentration as shown in Table 5. The anaerobic tank is capable of reducing approximately 90% BOD, 80% TSS, high in nitrate (NO₃), and some nitrite (NO₂) according to "HANDLING OF BY-PRODUCTS AND TREATMENT OF WASTE" by the Food and Agriculture Organization of the United Nations (also known as FAO). An anaerobic septic tank is one of the most economical nutrient treatment methods. No additional energy cost of recycling and controlling will be necessary in the tank as opposed to aerobic treatment.

The pH adjustment and coagulants addition may be designed and installed before wastewater flows into the anaerobic tank to further optimize treatment. However, an inline pH monitoring system is roughly \$20,000 USD (\$17,500 for the CC-1 model by Striem and \$2,500 USD for other necessary equipment, see Appendix B). A less costly option is to install two tanks in series and

test and adjust the pH daily in the first tank. This batch type arrangement would require a portable pH meter which is plus/minus \$1,000 depending on the model (see Appendix B). Unfortunately, pH adjustment is necessary for processes that encounter detergents, blood, and other animal wastes in the waste stream. Coagulants are generally available in organic forms or inorganic forms. Organic coagulants are generally made of polyamine and polyDAMAC or melamine formaldehydes and tannins. The organic coagulants are more expensive than the inorganic ones. More often, inorganic solutions like aluminum sulfate (alum), aluminum chloride, Polyaluminum Chloride (PACl) and Aluminum Chlorohydrate (ACH) are applied in wastewater treatment. We recommend the alum solution as the coagulant as the other options are more expensive. We cannot emphasize enough the importance of separating blood disposal from the septic system as we have addressed previously. This will not only ease the operation and optimize septic performance but also will decrease the cost of chemical purchases and additional treatment storage requirements.

The effluent from the anaerobic tank prior to subsurface disposal must meet the minimum dispersal requirement as presented in Table 7. The treated wastewater will meet the requirement per rule 15A NCAC 02T .0505 (b) as shown in the following table. The wastewater is considered as industrial wastewater per category listed in 15A NCAC 02T .0103 (20).

Table 7 Treatment Effluent Limitations

Wastewater Containment	Concentrations
BOD5	≤ 30 mg/l
TSS	≤ 30 mg/l
NH3	≤ 15 mg/l
Fecal Coliforms	≤ 200 colonies/100 ml

In accordance to rule 15A NCAC 18A .1952, 1,986 gallon minimum liquid capacity is required for the sedimentation tank. The pre-treatment (anaerobic) tank is recommended to be 4,000 gallons (David Brantley & Sons Model ST H20-561 or equal) considering potential business future growth. A traffic rated tank is recommended for trucking and animal passing safety concerns. Non-traffic rated tanks are acceptable if the areas are protected from vehicular and animal traffic. The anaerobic tank will provide sufficient detention time for bacteria to reduce the BOD level before subsurface drainage.

The proposed effluent disposal is subsurface disposal. This system is often lower in cost and easier to operate than the alternatives. As mentioned earlier, the design for such systems is dependent on the long term acceptance rate (LTAR) of the soil present. Based on the analysis provided by Licensed Soil Scientist Alex Adams, the acceptable LTAR for the soil is 0.4, however, with the usage of an innovative technology, a 25% reduction is acceptable. This results in the usage of fewer drainfield lines needed to dispose of the treated wastewater. The drainfield will consist of two part, the initial and repair drainfields which will be lain adjacent to one another. The initial drainfield will consist of 5 lines ranging from 65 to 90 feet in length stretching from the South-West corner of the lot Eastward. A repair field is laid out for the scenario where the initial field must be taken offline for repairs. The repair field will be lain within similar spacing intervals of the initial field positioned slightly North of the Initial field, also consisting of 5 lines, all at a length of 90 feet. The drip irrigation lines are dosed by the hydraulic unit. These lines consist of a hollow pipe filled with pressure compensating drip emitters spaced on two-foot intervals. For this case,

it is recommended that EZflow Geosynthetic Aggregate Technology 12-inch diameter bundles are used and should be installed per manufacturer recommendation. These emitters insure that there is uniform distribution of the treated wastewater throughout the disposal fields. The drip line systems will follow the contour lines at two-foot horizontal spacing and make a complete loop back to the dosing tank. This insures that proper pressure is maintained in the drip lines and that there is a means for flushing the lines in the instance that they become clogged.

As for the power need for the building, well and the wastewater system, electricity should be connected to the nearest power pole by a certified electrical contractor.

Additional Treatment Option:

Additional treatment is available if the owner or state regulatory agency demand further treatment steps after the anaerobic treatment in the septic tank. The wastewater treatment system will consist of one (1) Model 1200 E-Z Treat recirculating media filter (treatment unit), one (1) E-Z Treat recirculation tank, one (1) field dosing / storage tank, an ultraviolet disinfection unit, and all the necessary appurtenances. The wastewater enters the E-Z Treat recirculation tank where it is pumped through the E-Z Treat treatment unit. The E-Z Treat treatment unit removes additional BOD that were not removed in the previous screening and treatment steps. The wastewater then flows by gravity into the E-Z Treat recirculation tank or is diverted to the field dosing/storage tank by means of an effluent bypass valve. Wastewater flowing into the field dosing/storage tank is treated by an ultraviolet disinfection unit prior to entering the tank. One adequately sized pump tank may be divided into two separate compartments to serve as the recirculation chamber and the field dosing chamber. Each of these treatment units are described in additional detail below.

E-Z Treat Recirculation, and Field Dosing / Storage Tanks:

The E-Z Treat recirculation tank will be provided as specified on the construction drawings, or approved equal by Engineer. Septic tank effluent will drain into the E-Z Treat recirculation tank. Wastewater will be pumped from the E-Z recirculation tank into the E-Z Treat treatment unit, and the E-Z Treat treatment unit effluent will flow by gravity into the E-Z Treat recirculation tank or the field dosing / storage tank. The field dosing/storage tank shall be provided as specified on the construction drawings, or approved equal by Engineer. The effluent from the field dosing / storage tank will be pumped to the disposal fields.

The E-Z Treat recirculation and field storage/dosing tanks will be connected to audible and visible high water alarms. These alarms will alert the operator when too much wastewater has accumulated in the tanks so that he may turn on the pumps to empty the tank. If the property, otherwise specified on the construction drawings, is served by a well system, water will not be used during a power failure. A portable generator shall be provided if water is used during power failure at the slaughtering facility.

E-Z Treat Treatment Unit:

The Model 1200 E-Z Treat treatment unit will be used to provide additional treatment to the septic tank effluent as well as removing suspended solids not removed by the septic tank. The treatment unit will be housed in the container provided by E-Z Treat. The E-Z Treat treatment unit will be dosed by a Sta-Rite pump (Catalog Number STEP 30, ½ hp) with a distribution system placed

above the styrene media which will discharge onto the media. The underdrain system will transport the E-Z Treat treatment unit effluent back into the recirculation or field dosing / storage tank.

Ultraviolet Disinfection Unit:

The ultraviolet disinfection unit will be used to treat the E-Z Treat treatment unit effluent before it reaches the field dosing / storage tank. The ultraviolet disinfection unit shall be E-Z Treat UV-101, or approved equal by Engineer.

Summary of Costs

Please see the summary of the cost for the recommended water and wastewater construction.

Table 8: Total Cost of Water & Wastewater Systems

Items	Cost (USD)
Water Connection (Back Flow Preventer May be Required)	\$ 4,000
Wastewater Treatment Equipment (pH adjustment included)	\$ 45,000
Contingency (10% of project total)	\$ 5,450
Engineering Wastewater Only	\$ 5,500
Total Cost of Water & Wastewater systems	\$ 59,950

Table 9 shows the wastewater treatment system cost if the owner decides to install further wastewater treatment. An update of a more precise quote will be provided by the E-Z Treat manufacturer upon request. Please contact Cory Brantley at 1installer@gmail.com for price updates and E-Z Treat manufacturer’s information.

Table 9: Cost of Wastewater System (Only) With E-Z Treat Treatment

Items	Cost (USD)
One (1) Solid Interceptor (Striem AA-XL)	\$ 4,600
One (1) Grease Trap (Schier GB-250)	\$ 5,534
One (1) pH Unit	\$ 1,000
One (1) Anaerobic/Pretreatment Tank	\$ 3,500
One (1) E-Z Treat Treatment Pod	\$ 2,500
One (1) E-Z Treat Recirculation Tank	\$ 2,500
One (1) Storage/Dosing Tank	\$ 1,800
Treatment Construction	\$ 25,266
Contingency (10 %)	\$ 5,800
Engineering Wastewater Only	\$ 5,500
Cost of Wastewater System With E-Z Treat Treatment	\$ 58,000

APPENDIX A

Subsurface & Surface Setback Rules (Not Included)

APPENDIX B

Proposed Equipment

Manufacturers' Cut-Sheets

(See Separate Section)

Ziad Qudwa
Custom Exempt Slaughterhouse On-Site System

Wastewater Analysis

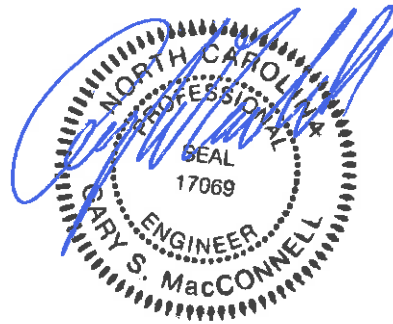

MacConnell & Associates, P.C.
1101 Nowell, Road, Suite 118
Raleigh, North Carolina 27607

P.O. Box 129
Morrisville, North Carolina 27560

Phone: (919) 467-1239
Fax: (919) 319-6510

Custom Exempt Slaughterhouse Wastewater Analysis

To: Ms. Lorna C. Withrow, PE,
Environmental Engineer
Division of Public Health, On-Site Water Protection Branch

From: Gary S. MacConnell, P.E. and Aershen Muheyati

Date: December 5, 2018

Client: Ziad Qudwa (Qudwa Investments, LLC)

Subject: Custom Exempt Slaughterhouse Wastewater Analysis

Project No. A67601.00

Introduction

MacConnell & Associates, P.C. (M&A) has been contracted to design wastewater treatment and disposal systems for a proposed simple/custom exempt slaughterhouse for Mr. Ziad Qudwa at 1253 Atkins Road in Harnett County, North Carolina. This analysis consists of an evaluation of: the existing site conditions, wastewater flow analysis, and recommendations for water supply. The wastewater treatment and disposal systems will be discussed in details outside of this wastewater analysis section.

Existing Conditions

The site is located on a 5.3 acre parcel of land with an existing single family residence and several sheds. The current residence is served by county water as well as a private subsurface septic system. A new slaughtering building is proposed at the northern side of the farm. The owner will need to extend water service to the building for potable water supply. Wastewater treatment and disposal systems will also be designed and installed for the slaughterhouse operation as public sewer is not available at the site.

Proposed Business Classification and Type

Per inspection requirements for meat and poultry businesses by North Carolina Department of Agriculture and Consumer Services (NCDA&CS), the slaughtering facility will be considered as a custom exempt facility as the owner only wishes to provide services for slaughtering and processing meat and poultry for the general public for personal consumption only.

A custom exempt facility processes products such as meat, poultry and wild game (deer e.g.) for private individuals only. All products are marked "NOT FOR SALE" and identified by the owner's name. These facilities are inspected for sanitation and proper labeling of products. The meat and poultry products are not

inspected for disease or quality and cannot enter commerce. All products must be returned to the original owner for his/her personal use and cannot be sold.

In order to obtain the custom exempt status, the facilities must first meet regulatory performance standards. For example, production rooms constructed of materials impervious to moisture; adequate restrooms, hand wash stations, lighting, ventilation, drainage; equipment and utensils which are cleanable and maintained in sanitary condition, etc. A free analysis can be provided by NCDA&CS. Secondly, an Application for Inspection to NCDA&CS must be completed and submitted. Thirdly, obtain an approved well or public water permit and a wastewater construction authorization permit through local or state environmental health agencies. Lastly, provide the written documents about hours of operation, request to dispose of inedible wastes, chemical list, and safety data sheets. This submittal is for the wastewater construction authorization permit application.

Flow Analysis

We have summarized the wastewater flow based on the information provided in Table 1. This table provides the average weight of each livestock, average number of livestock processed, and the water usage based on EPA design guidelines for meat processing facilities. Per EPA’s "Technical Development Document for the Final Effluent Limitations Guidelines and Standards for the Meat and Poultry Products Point Source Category (40 CFR 432)", no value for goat and lamb water usage was found. Since hogs are closer in size to goats and lambs than cattle (hogs used 291 - 442 gallons per 1,000 lbs. and cattle used 532 gallons per 1,000 lbs.), we used 400 gallons per 1,000 lbs. for goats and lambs. In addition, it is important to note that a halal preparation of one (1) veal slaughtering service is very unlikely but would utilize 1,277 gallons of water (2,400 lbs/kill*532 gallons/1000lbs). However, we decided to use this number to calculate the peak demand of the system on worst case scenario.

Table 1. Factors used to calculate water usage of the slaughter operation.

Processed Animal Type and Average Weight	Numbers Processed/Week	Average Water Usage/1,000 lbs.
Goats (310 lbs./kill)	6	400
Lambs (350 lbs./kill)	6	400
Veal (2,400 lbs./kill)	1	532
Chicken (3.83 lbs./kill)	51	2,428

The wastewater is analyzed on the basis of 7 days per week of flow cycle. The estimated slaughtering operation per week is provided in the table below.

Table 2: Estimated Slaughterhouse Operation

Livestock	Chicken	Sheep/Goat	Veal
Monday	3	0	0
Tuesday	3	1	0
Wednesday	5	1	0

Thursday	5	1	0
Friday	5	3	0
Saturday	15	3	1
Sunday	15	3	0
Ave. Livestock/Week	51	12	1

Based on the tables provided above, the flow usage can be calculated as shown in Table 3.

Table 3: Slaughtering Water Usage:

Day	Chicken (Gal)	Sheep/Goat (Gal)	Veal (Gal)	Total Flow (GPD)
Monday	28	0	0	28
Tuesday	28	140	0	168
Wednesday	46	140	0	186
Thursday	46	140	0	186
Friday	46	420	0	466
Saturday	139	420	1277	1836
Sunday	139	420	0	559
Weekly Flow (GPW)	474	1680	1277	3431

In evaluating the methods above for calculating process flows with consideration of domestic wastewater from 5 maximum employees (25 gallons/employee * 5 employees = 125GPD) which gives a total weekly domestic wastewater 875 GPW (125GPD * 7 days), we propose an equalized design flow of 615 GPD, which is the sum of 3,431 GPW of industrial flow from slaughtering operations and 875 GPW of domestic wastewater from the employees divided by 7 days of operation per week. More detailed flow analysis is shown in the equalization calculation section of this submittal.

Wastewater Analysis

The principle sources of wastewater and wastes are from livestock holding, killing, hair removal, eviscerating, carcass washing, trimming, and general cleanup operations. Wastewater from the slaughter operation is typically considerably higher than domestic strength wastewater. Wastewater from the slaughtering of animals contains organic matter (grease and fats), suspended solids, and inorganic material such as phosphates, nitrates, nitrites, and salts. These materials enter the wastewater treatment system as blood, meat and fatty tissue, meat extracts, paunch content, bedding, manure, hair, dirt, potential contaminated cooling water losses from rendering, curing and pickling solutions, preservatives, and caustic or alkaline detergents. Biochemical oxygen demand (BOD) from blood is high in concentration as well as total suspended solids (TSS), and nitrogen (N). A generalized raw wastewater pollutant summary of slaughterhouse wastewater which was conducted by the United States Environmental Protection Agency (EPA) is shown below in Table 4.

Table 4. Summary of plant and raw waste characteristics for a simple slaughterhouse based on 1,000 kg of livestock killed (EPA).

Base	Flow 1/1000 kg LWK	Kill 1000 LWK/day	BOD5 kg/1000 kg LWK	Suspended solids kg/1000 kg LWK	Grease kg/1000 kg LWK	Kjeldahl Nitrogen as N kg/1000 kg LWK
Facilities Studied	24	24	24	22	12	5
Average	5,328	220	6.0	5.6	2.1	0.68
Std. Dev.	3,644	135	3.0	3.1	2.2	0.46
Range	1,334- 14,641	18.5-552	1.5-14.3	0.6-12.9	0.24-7.0	0.23-1.36

The total weight of livestock processed are calculated based on the average animal weights provided in Table 1 and the number of livestock processed per day in Table 2. Table 5 shows a weekly summary of the animal weight produced during one operation cycle.

Table 5: Estimated Total Weight Processed:

Livestock	Chicken	Sheep/Goat	Veal	Unit
Monday	11	-	-	lbs
Tuesday	11	350	-	lbs
Wednesday	19	350	-	lbs
Thursday	19	350	-	lbs
Friday	19	1,050	-	lbs
Saturday	57	1,050	2,400	lbs
Sunday	57	1,050	-	lbs
Livestock/Week	195	4,200	2,400	lbs

Table 4 summarizes average BOD5, TSS, FOG, and TKN weight produced based on 24 facilities studied. The units are all in kilograms per 1000 kilograms livestock processed. Table 5 indicates the total weight produced during an operation cycle. After unit conversions, the total pollutants weights can be assessed as Table 6 by combining the information in both tables (Table 4 and Table 5).

Table 6: Estimated Pollutants in kg

Livestock	BOD5	TSS	FOG	TKN	
Monday	0.031	0.029	0.011	0.002	kg
Tuesday	0.986	0.920	0.345	0.076	kg
Wednesday	1.007	0.940	0.352	0.077	kg
Thursday	1.007	0.940	0.352	0.077	kg

Friday	2.916	2.721	1.021	0.224	kg
Saturday	9.566	8.928	3.348	0.733	kg
Sunday	3.020	2.819	1.057	0.232	kg

Finally, the total water usage provided in Table 3 and the slaughterhouse pollutants produced in Table 6 can help characterize the influent pollutants concentrations. We recommend the wastewater characterization of the proposed slaughterhouse as presented in Table 7.

Table 7. Proposed slaughterhouse wastewater characteristics.

Major Contaminants	Concentration (mg/L)
BOD5	1,654
Suspended Solids	1,543
Grease	579
Kjeldahl Nitrogen (N)	127

Blood is a valuable product and should be collected and not introduced into the waste stream. It may be collected: for a food source, for rendering, dried and used for fertilizer, or for composting. This also helps to keep high strength pollutants (BOD, etc.) out of the wastewater system. The pH of the wastewater may vary because of inclusion of detergent, blood and other contaminations. However, the pH is to be maintained in between 6 to 9 at all times. All solid wastes from livestock will be rendered by Valley Protein or disposed off-site at a permitted location.

Field Analysis

The field capacity is calculated based on the maximum septic field available, soil conditions and long term acceptance rate (LTAR) provided by Licensed Soil Scientist Alex Adams. The estimated drain field size is calculated based on the subsurface disposal option. Per soil scientist Alex Adams, the proposed LTAR will be 0.40 gallons per day (GPD) per square feet (SF). The irrigation field will be located on the Southwest side of the property, yielding about 12,000 square feet with approximately (\pm) 600 gallons per day of disposal capacity. The initial system has 405 linear feet of drain lines, and the repair system has 450 linear feet of drain lines.

Water Supply

There is a nearby public water service to the site, and the connection is located along Atkins Road on the Eastern side of the proposed building. To request an installation of a water service for a commercial business, Harnett County Department of Public Utilities shall be contacted at 910-893-7575 for required fees. Once the fees are established for the commercial services, application will need to be made at the Public Utilities office at 700 McKinney Parkway in Lillington. It is required to obtain a permit from the Central Permitting office of Harnett County.

Another option is constructing a private well to serve the slaughterhouse at the current site. The construction of the well will not require a permit from the Regional Office under North Carolina Division of Water Resources because the water usage will be under 100,000 gallons per day. The Public Water Resources will not have additional requirements for the well since the proposed number of employees will be under 25. However, a well permit from Harnett County Environmental Health Department will be required. Since public water is available at a reasonable distance to the site, we do not recommend a well construction because there will be further potential costs for water monitoring and well maintenance.

Ziad Qudwa
Custom Exempt Slaughterhouse On-Site System

Project Specifications

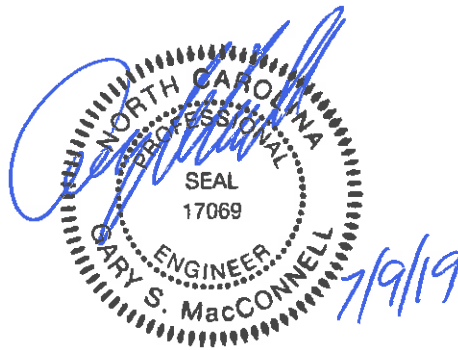

MacConnell & Associates, P.C.
1101 Nowell, Road, Suite 118
Raleigh, North Carolina 27607

P.O. Box 129
Morrisville, North Carolina 27560

Phone: (919) 467-1239
Fax: (919) 319-6510

Table of Contents for Specifications

Excavation and Backfilling	1
Septic, Grease Trap, Recirculation, and Field Dosing Tank Installation and Testing	2
Piping Installation and Testing	4
E-Z Treat Dosing Pump and Control Panel	4
E-Z Treat Treatment Unit Installation	5
Effluent Bypass Valve	5
Denitrification Assembly	5
Ultraviolet Disinfection Unit	5
Manifold Control Panel and Pumps	5
Trench Lines	6

Project Specifications

Excavation and Backfilling

1. Excavated materials acceptable as backfill shall be stockpiled in a location approved by the Owner. The materials shall be located away from the edge of any excavations. Excavated materials shall not be stored where existing trees are located.
2. All open excavations shall be barricaded when construction in the area has stopped. Night barricading should include posted warning lights.
3. Protect existing structures, utilities, sidewalks, pavement, and other facilities from damage caused by settlement, lateral movement, undermining, washout, and other hazards created by earthwork operations. Protect root systems from damage or dry-out to the greatest extent possible.
4. Soil materials shall be free of boulders, roots, sod, organic matter, and frozen material.
5. Bedding materials for pre-cast concrete structure installation shall be #57 washed stone to the dimensions and depth shown on the construction drawings.
6. All excavation is unclassified and includes excavation to subgrade elevations indicated on the construction drawings regardless of character of materials and obstruction encountered. In the event that rock is encountered, the Contractor shall remove it at no additional cost to the owner.
7. Stability of excavations shall be maintained by sloping of the sides and shall comply with local codes, ordinances, and requirements of agencies having jurisdiction. Where space restrictions prevent sloping of the sides, shoring and bracing of the walls shall be employed in full compliance with OSHA requirements. In the case of pipe installations, sheeting shall remain in place until backfilling progresses to a stage where no damage to the pipe will result from removal.
8. The Contractor shall attempt to prevent surface and subsurface water from flowing into excavations. The Contractor shall provide equipment, materials, and work necessary to dewater any accumulation of water in the excavation to prevent softening of the soils, undercutting of footings, and changes to the soils detrimental to the stability of the improvements.
9. Excavations for structures shall conform to dimensions and elevations shown on the construction drawings within a tolerance of plus or minus 0.10 feet and to the standards of ASTM C891-90.

10. Backfill shall be installed to excavated spaces in 8-inch lifts and tamped by hand or pneumatically around pipe or structures. Tamping shall be performed evenly on both sides of pipe and around sides of structures to a depth such that damage to the pipe or structures is avoided as a result of subsequent methods of compaction. Extreme care shall be exercised in backfilling operations to avoid displacement of pipe and structures either horizontally or vertically. Backfill consolidation by ponding water is not permitted. Compaction of each layer of backfill and the top 6 inches of subgrade shall achieve a 90 percent maximum dry density as measured by AASHTO method T-99.
11. Remove all waste materials including unacceptable excavated material, trash, and debris and legally dispose of it off Owner's property. Where settling is measurable or observable at excavated areas during project warranty period, the Contractor shall remove surface finish, add backfill material, compact, and replace surface treatment to a quality and appearance matching adjacent areas of previous work.
12. Site specific excavation and backfilling requirement shall also comply as shown on the construction drawings.

Septic Grease Trap, Recirculation and Field Dosing Tank Installation and Testing

1. Septic tanks shall conform to criteria in 15A NCAC 18A .1952-.1954. The septic and field dosing tanks should be installed on a 6-inch minimum layer of No. 57 washed stone aggregate.
2. Place bell ends of pre-cast sections or the groove end of the concrete facing down. In preparation for making joints, all surfaces of the portion of the section to be jointed and the factory-made jointing materials shall be clean and dry. Each joint, seam, and pipe penetration inside and outside of joints shall receive liberal applications of non-shrink grout as well as liberal amounts of bitumastic waterproof sealant.
3. Lifting holes and other penetrations of the pre-cast structure wall shall be sealed with nonshrinking grout. Pipe connections shall be made so that the pipe does not project beyond the inside wall of the structure. Grout connections as necessary to make smooth and uniform surfaces on the inside of the structure.
4. Before placing any tank into operation, remove any dropped grout, sand or other imperfections and obstructions from the interior of the structure. Specifically, the inside walls of the tank shall be smooth and uniform. Smooth-finish inverts so that wastewater flow is confined and directed through the inlet and outlet pipes with easy transition.
5. Tanks shall be backfilled in accordance with the applicable specifications herein before described.

6. All pipe penetrations shall be through Press-Seal Cast-A-Seal 402 rubber connectors or approved equal.
7. All joints (mid-seam, top-seam) shall be sealed using Concrete Sealants butyl sealant #CS-102 meeting ASTM C-990.
8. All service access openings will be a minimum of 24 inches. Exceptions may be made on a case by case basis with E-Z Treat's and engineer's prior written approval. All access openings shall be fitted with E-Z Set riser assemblies.
9. A 24-hour static water test, in accordance with ASTM standards, shall be performed on all precast tanks in order to insure they are water tight.
 - a. The testing shall be performed in the presence of the engineer or his representative.
 - b. Each tank shall be filled with water and the initial water level shall be measured.
 - c. At the end of the 24-hour period, the level of the water shall be measured again.
 - d. The engineer shall pass the tank if the water level did not drop more than 0.5 inches or if the total volume of the displaced water is less than 1 percent of the total effective liquid capacity of the tank.
 - e. Tanks may also be leak-tested by applying a vacuum of 5-inches of Hg with riser assemblies in place.
 - f. Each failed tank shall be tested again. In the event that the tank does not pass the second test, the Contractor shall remove and replace the tank at no additional cost to the owner.
10. Septic Tank and Field Dosing Tank shall meet the following additional criteria:
 - a. Minimum liquid depth of 36 inches.
 - b. Minimum airspace of 8 inches.
 - c. Length shall be at least twice as long as the width.
 - d. Septic tank shall be constructed with a baffle wall dividing the tank interior $2/3^{\text{rd}}$ to $1/3^{\text{rd}}$. The baffle wall shall be constructed to permit passage of effluent through a slot or holes located between 45 and 55 percent of the interior depth.
11. Septic tank shall be fitted with a POLYLOK effluent filters, or engineer approved equal, that extends down to 50 percent of the liquid depth of the tank.

12. Septic and field dosing tank model shall be as shown on the construction drawings or approved equal by engineer.

Piping Installation and Testing

1. Piping shall be PVC and of type and size as shown on the construction drawings. Piping shall be installed with a minimum of three (3) feet of cover unless shown otherwise on the construction drawings.
2. Piping shall be installed to be able to meet a pressure test whereby the pressure remains constant for a minimum of two hours, and the allowable leakage is not more than 10 gpd/inch of pipe diameter/mile.
3. Any line installed under a driveway shall be sleeved in Class 52 Ductile Iron Pipe or encased in concrete and extend a minimum of 5 feet on either side and as shown on the construction drawings.
4. Force mains installed under streams shall be sleeved in Class 52 Ductile Iron Pipe as shown on the construction drawings.

E-Z Treat Dosing Pump and Control Panel

1. The E-Z Treat dosing pumps shall be one Sta-Rite Step 30 1/2 horsepower multi-stage submersible pump for operation on a single phase, 115 Volt service.
2. The control panel shall be an E-Z Treat provided simplex panel. The panel shall have a recirculation pump load sensor/alarm, two on/off timers, discharge pump alarm, high/low water alarm, and low water level/run dry pump protection.
3. The control panel shall be in a NEMA 4X enclosure, installed in accordance with the manufacturer's recommendations, and within 10 feet of the E-Z Treat treatment unit.
4. No splices may be placed in the pump tank or riser. All splices shall be made above ground in a NEMA 4x junction box.
5. Control and alarm circuits shall be on separate circuits.
6. The telemetry control and alarm system shall be OmniBeacon by OmniSite. System operator must be able to access the panel directly on site and shall be available with a 24 hour notice to the county in the event a direct connection is necessary.
7. The audible/visual alarms shall be external to any structure.

E-Z Treat Treatment Unit Installation

1. The E-Z Treat Treatment Units shall be installed in accordance with the manufacturer's recommendations and as shown on the contract drawings.

Effluent Bypass Valve

1. The effluent bypass valve shall be by E-Z Treat and shall be installed in accordance with the manufacturer's recommendations and as shown on the contract drawings.

Denitrification Assembly

1. Valves and piping back to the front of the septic tank shall be integral with the pod dosing system.

Ultraviolet Disinfection Unit

1. The ultraviolet unit shall be installed in accordance with the manufacturer's recommendations and as shown on the contract drawings. The unit shall be by E-Z Treat UV-101 or approved equal by engineer.
2. A visual alarm shall be provided that alerts the homeowner when the primary bulb fails. After primary bulb failure, the backup bulb shall be good for 10,000 hours. Alarm panel shall be mounted within 6 feet of ultraviolet casing.
3. Casing shall be filled with water prior to powering up lamps.

Manifold Control Panel and Pumps

1. The control panel shall be by the EZ Series Demand Dosed Simplex Control Panel by SJE Rhombus, or approved equal by engineer. The control panel will have the dose volume to be set as shown on the construction drawings.
2. The control panel shall be as specified on the construction drawings and installed per manufacturer's recommendation.
3. Manifold pump will be Zoeller High Head Flow-Mate Series, Model E188, 1-1/2 HP, 230 Volts or approved equal by engineer.

4. Disposal field is designed to receive 314-gallon adjusted daily design flow from the dwelling per dose. The flow will be controlled with the use of a simplex control panel as shown on the construction drawings.

Trench Lines

1. The trench lines shall be conventional 4" corrugated drain lines.
2. The trench lines shall be installed per manufacturer's recommendations unless shown otherwise on the construction drawings.

Ziad Qudwa
Custom Exempt Slaughterhouse On-Site System

Soils Evaluation

MacConnell & Associates, P.C.
1101 Nowell, Road, Suite 118
Raleigh, North Carolina 27607

P.O. Box 129
Morrisville, North Carolina 27560

Phone: (919) 467-1239
Fax: (919) 319-6510

SOIL/SITE EVALUATION
for ON-SITE WASTEWATER SYSTEM

OWNER: Qudwa Investments, LLC
 ADDRESS: 1253 Atkins Road, Fuquay-Varina, NC 27526
 PROPOSED FACILITY: custom exempt slaughterhouse
 PROPOSED DESIGN FLOW: 650 GPD
 LOCATION OF SITE: 1253 Atkins Road
 WATER SUPPLY: Public
 EVALUATION METHOD: Auger Boring

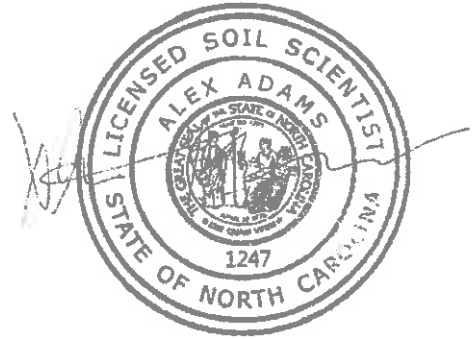

P R O F I L E #	.1940 LANDSCAPE POSITION/ SLOPE %	HORIZON DEPTH (IN.)	SOIL MORPHOLOGY (.1941)		OTHER PROFILE FACTORS				PROFILE CLASS & LTAR
			.1941 STRUCTURE/ TEXTURE	.1941 CONSISTENCE/ MINERALOGY	.1942 SOIL WETNESS/ COLOR	.1943 SOIL DEPTH	.1956 SAPRO CLASS	.1944 RESTR HORIZ	
1	LS/5%	A - 0-4	SL, GR	FR, NS, NP	10 YR 5/2				PS, 0.4
		A/E - 4-14	SL, GR	FR, NS, NP	10 YR 6/4				
		Bt - 14-32	SCL, SBK	FI, SS, SP	10 YR 5/6				
					10 YR 6/2 mottles @28"				
2	LS/5%	A/E - 0-8	SL, GR	FR, NS, NP	10 YR 6/4				PS, 0.4
		Bt1 - 8-26	SCL, SBK	FI, SS, SP	10 YR 5/6				
		Bt2 - 26-40	SCL, SBK	FI, SS, SP					
					10 YR 5/6 10 YR 6/2 mottles @26"				
3	LS/5%	A/E - 0-8	SL, GR	FR, NS, NP	10 YR 6/4				PS, 0.4
		Bt1 - 8-34	SCL, SBK	FI, SS, SP	10 YR 5/6				
		Bt2 - 34-45	SCL, SBK	FI, SS, SP					
					10 YR 5/6 10 YR 6/2 mottles @34"				

4	LS/5%	A/E - 0-8	SL, GR	FR, NS, NP	10 YR 6/4				PS, 0.4
		Bt1 - 8-26	SCL, SBK	FI, SS, SP	10 YR 5/6				
		Bt2 - 26-40	SCL, SBK	FI, SS, SP	10 YR 5/6				
					10 YR 6/2				
					mottles @26"				

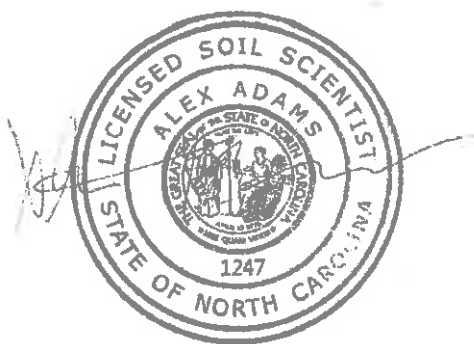

Preliminary Soils Evaluation
 Qudwa Investments, LLC
 Custom Exempt Slaughter House
 Harnett County, NC

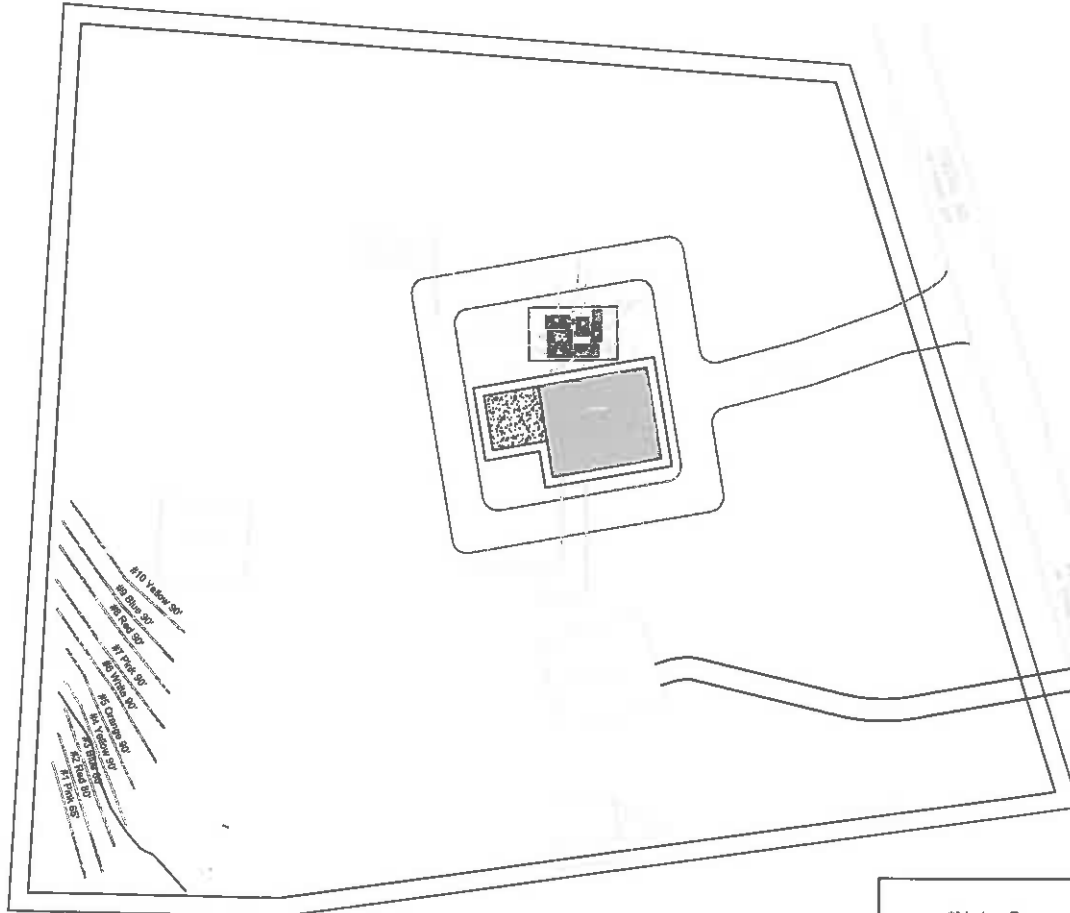

*Not a Survey

System: To be designed by engineer
 Lines: 1-5, (400')
 0.4 LTAR
 12" Trench Bottom
 Accepted Status System
 System: To be designed by engineer
 Lines: 4-7, (450')
 0.4 LTAR
 12" Trench Bottom
 Accepted Status System

- *Preliminary Soils Evaluation
- *Soil boundary was sketched onto a preliminary map of the property supplied by the client's surveyor.
- *Not a Survey.
- *Septic system setbacks listed below for new lots.
- 1) 10' from property lines.
- 2) 100' from wells for primary systems.
- 3) 50' from surface waters (streams, ponds, lakes).
- *Any mechanical disturbances such as grading, cutting and filling of the suitable soil areas can render areas unsuitable for future septic systems.
- *See accompanying report for additional information.
- *Due to Soil Variability, Adams soil consulting cannot guarantee that the areas shown as suitable will be permitted by the local Health Department.

*6-8" of approved fill material will need to me added to septic field at time of installation

GRAPHIC SCALE
 1" = 100'



Adams
 Soil Consulting
 919-414-6761
 Project #787

Zack Qudwa
1253 Atkins Road, Harnett County



*Preliminary soil investigation only, do be used for initial planning purposes.

Legend



Areas contain soils with 30 inches or more of useable material and have potential for conventional, modified conventional, LPP or ultra-shallow conventional septic systems. There may be inclusion of soils 24-29 inches to a restrictive horizon that will have potential for LPP septic systems.

US

Unsuitable areas for conventional wastewater systems

GRAPHIC SCALE

1" = 100'



Adams
Soil Consulting
919-414-6761
Job #xxx

Preliminary Soils Evaluation
Qudwa Investments, LLC
Custom Exempt Slaughter House
Harnett County, NC

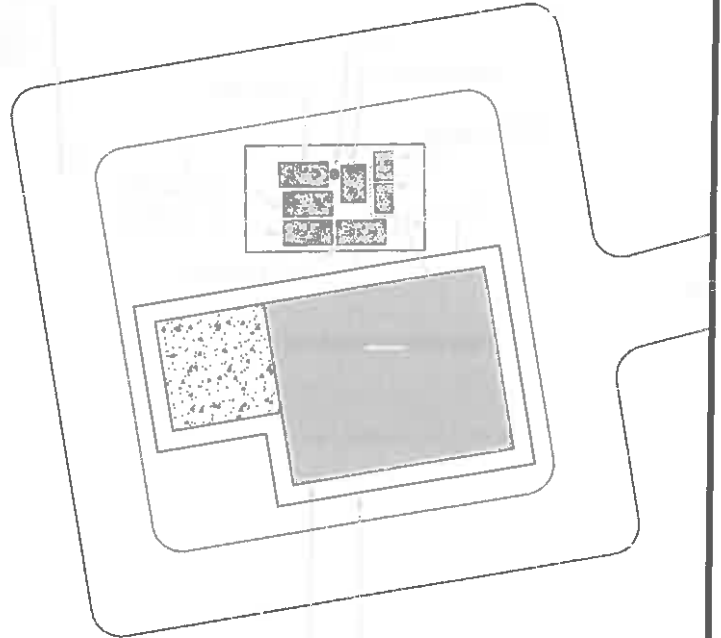

- #10 Yellow 90'
- #9 Blue 90'
- #8 Red 90'
- #7 Pink 90'
- #6 White 90'
- #5 Orange 90'
- #4 Yellow 90'
- #3 Blue 90'
- #2 Red 80'
- #1 Pink 65'

System: To be designed by engineer
Lines: 1-5, (400')
0.4 LTAR
12" Trench Bottom
Accepted Status System
System: To be designed by engineer
Lines: 4-7, (450')
0.4 LTAR
12" Trench Bottom
Accepted Status System

*6-8" of approved fill material will need to be added to septic field at time of installation
Due to limited available space system will need to be flagged prior to installation.

GRAPHIC SCALE
1" = 50'



Adams
Soil Consulting
919-414-6761
Job #787

Ziad Qudwa

Slaughter House Facility (650 gal./day) with 25% reduction product

<u>LINE #</u>	<u>COLOR</u>	<u>BS</u>	<u>HI</u>	<u>FS</u>	<u>ELEVATION</u>	<u>LINE LENGTH</u>	<u>Design Length</u>
TBM		0.0		100.0		<u>in field</u>	<u>installation</u>
INST. 1			100.0				
1	Pink			0.0	100.0	65	65
2	Red			0.4	99.6	80	80
3	Blue			1.0	99.0	80	80
4	Yellow			1.5	98.5	90	90
5	Orange			5.1	94.9	90	90
6	White			2.7	97.3	90	90
7	Pink			3.4	96.6	90	90
8	Red			4.0	96.0	90	90
9	Blue			4.6	95.4	90	90
10	Yellow			5.2	94.8	105	90
					Total	870	855

System Type	<u>System</u> Lines 1-5 Accepted Status System EZ-FLOW	<u>Repair</u> Lines 6-10 Accepted Status System EZ-FLOW
Suggested Soil LTAR	0.40	0.40
Total Line Length	405	450
Square Footage	1215	1350
Proposed Trench Bottom	12"	12"
Distribution Method	Pressure Manifold	Pressure Manifold

Ziad Qudwa
Custom Exempt Slaughterhouse On-Site System

Design Calculations

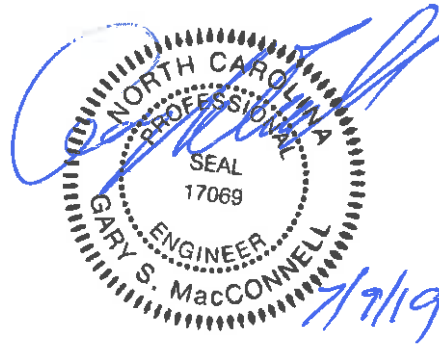

MacConnell & Associates, P.C.
1101 Nowell, Road, Suite 118
Raleigh, North Carolina 27607

P.O. Box 129
Morrisville, North Carolina 27560

Phone: (919) 467-1239
Fax: (919) 319-6510

MacConnell & Associates, P.C.

Project: Ziad Qudwa Custom Exempt Slaughterhouse
 Project Number: A67601.00
 Location: Harnett County
 Subject: Flow Equalization & Tank Sizing Calculations
 Date: December 5, 2018

Notes:
 Input
 Calculated

Assumptions And Calculations:

1. Treatment flow is based on unadjusted flow.
2. Irrigation flow is based on reduced flow

FLOW ANALYSIS:

Equalization Cycle:

7 days

Estimated Slaughter Operation

Livestock	Chicken	Sheep/Goat	Veal
Monday	3	0	0
Tuesday	3	1	0
Wednesday	5	1	0
Thursday	5	1	0
Friday	5	3	0
Saturday	15	3	1
Sunday	15	3	0
Ave. Livestock/Week	51	12	1

Water Usage per Livestock

	Average Weight/Kill (lbs)	Average Water Usage (Gal/1,000 lbs)
Chicken	3.83	2428
Sheep/Goat	350	400
Cattle/calve	2400	532

* Values are obtained from EPA and USDA design manual

Slaughtering Water Usage

	Chicken (Gal)	Sheep/Goat (Gal)	Veal (Gal)	Total Flow (GPD)
Monday	28	0	0	28
Tuesday	28	140	0	168
Wednesday	46	140	0	186
Thursday	46	140	0	186
Friday	46	420	0	466
Saturday	139	420	1277	1836
Sunday	139	420	0	559
Weekly Flow (GPW)	474	1680	1277	3431

	Employee
Operation/Cycle	Monday - Sunday
Operational days	7
Daily Flow per Employee Unit	25 gal/employee
Employees	5
Weekly Flow (GPW):	875

Per 15A NCAC 18A. 1949

Weekly Total: 4,306 GPW

Equalized Daily Flow: 615.15 GPD
 LTAR: 0.35 GPD/ft²
 Trench Bottom Area (Wetted Area): 1,758 ft²
 Trench Bottom Width: 3 ft
 Linear Footage: 586 ft
 Dose Volume (70% of 4" drainline capacity): 314 Gallons

Day	In (gal)	Out (gal)	Residual (day)	
Saturday	1,961	615	1,346.14	152.898
Sunday	684	615	1,415	292.898
Monday	153	615	953	311.496
Tuesday	293	615	631	311.496
Wednesday	311	615	327	591.496
Thursday	311	615	24	1961.29
Friday	591	615	0	684.489
Total	4306	4,306	0	

SEPTIC TANK SIZING

Largest Inflow Generated/Cycle:
 Septic Tank Volume Required:
 Septic Tank Volume Provided:

1,961 GPD
 2,596 Gallons
 3,160 Gallons

per 15A NCAC 18A .1952 (b)

Septic Tank storage and effective volume calculations:

Septic Tank Total Void Volume = L * W * D:

Tank length:

Tank Width:

Tank Depth:

Total Void Volume:

Septic Tank Effective Volume = L * W * Lowest Invert To Tank Bottom:

Tank length:

Tank Width:

Lowest Invert:

Effective Volume:

12.7 foot
 5.5 foot
 6.8 foot
 3,561 Gallons

12.7 foot
 5.5 foot
 6.0 foot
 3,127 Gallons

GREASE TRAP TANK SIZING

Grease Trap Size Required:
 Grease Trap Size Provided:

1,731 Gallons
 2,000 Gallons

per 15A NCAC 18A .1955 (k)

Grease Trap Tank capacity calculations:

Grease Tank Total Void Volume = L * W * D:

Tank length:

Tank Width:

Tank Depth:

Total Void Volume:

Grease Tank Effective Volume = L * W * Lowest Invert To Tank Bottom:

Tank length:

Tank Width:

Lowest Invert:

Effective Volume:

12.7 foot
 5.5 foot
 4.7 foot
 2,432 Gallons

12.7 foot
 5.5 foot
 3.8 foot
 1,998 Gallons

EQUALIZATION/FIELD DOSING TANK SIZING:

Emergency Storage Volume:
 Equalization Volume:
 Pump Dose Volume:
 Pump Submergence Volume:
 Minimum Equalization/Field Dosing Tank Volume:
 Equalization/Field Dosing Tank Volume Provided:

1,961 Gallons
 1,415 Gallons
 314 Gallons
 608 Gallons
 4,298 Gallons
 4,500 Gallons

Highest Daily Flow
 **

SECONDARY TREATMENT - E-Z TREAT SIZING:

Unadjusted Design Flow:
 Flow Reduction:
 Adjusted Flow:

615 GPD
 0 %
 615 GPD

15A NCAC 18A .1949

Sizing Calculations Per Innovative Approval

Table 1 - Model 600 and Tank Volumes

Design Daily Flow(gpd)	Minimum Septic Tank Volum (gallons)	Minimum Recirculation/Pump Tank Volume (gallons)**	Number of Media Pods
< 480	1,000	1,250	1 Model 600 pod
4 Bedrooms	1,000	1,800	1 Model 600 pod
5 Bedrooms	1,250	2,000	1 Model 600 pod
6 Bedrooms	1,500	2,200	2 Model 600 pod
601 - 1,500	$V=1.17Q+500$	$V=1.17Q+500$	1 Model 600 pod per 600 gallons
1,501 - 3,000	$V=0.75Q+1,125$	$V=0.75Q+1,125$	1 Model 600 pod per 600 gallons

**Recirculation/pump tank minimum size based on total internal tank volume.

Recirculation/Pump Tank Volume = Recirculation Tank(Chamber) Volume + Pump Tank(Chamber) Volume

E-Z TREAT DESIGN:

Pod Dimension - Length	7.3 Feet	Given
Pod Dimension - Width	4.0 Feet	Given
Pod Dimension - Height	3.3 Feet	Given
Pod Surface Area	28.9 ft ²	L x W
Rated Loading Rate per Pod	700.0 GPD	Given
E-Z Treat Pods Required:	0.9	ADF/Pod Loading Rate
E-Z Treat Pods Used:	2 Pod	
E-Z Treat Dose per Pod:	34.0 Gallons	Given
E-Z Treat Volume per Dose	68.0	Dose per Pod x Number of Pods
Re-Circulation Timer On:	2.5 Minutes	Given
Re-Circulation Timer Off:	18.0 Minutes	Given
E-Z Treat Re-Circulation Cycles per Day:	70 Cycles	Time per Day / Time per Cycle
Total E-Z Treat Flow per Day:	4,777 Gallons	E-Z Treat Volume/Dose x Cycles/Day
E-Z Treat Re-Circulation Ratio:	7.8	E-Z Treat Flow per Day / ADF

Denitrification Gallons Returned:

702.4 GPD

Denitrification Return Setting:

4.0 GPM

E-Z Treat Surface Area:

57.7 ft²

E-Z Treat Loading Rate:

10.7 GPD/ft²

ADF/Surface Area

E-Z Treat Recirculation Pump Selection Shall Be As Shown On Drawings.

Minimum Pump/Re-Circulation Tank Volume Required:

2,200 Gallons

Recirculation Tank Volume Provided:

1,850 Gallons

Field Dosing Tank Provided:

2,000 Gallons

Pump/Re-Circulation Tank Volume Provided:

3,850 Gallons

Recirculation Tank storage and effective volume calculations:

Recirculation Tank Total Void Volume = L * W * D:

Tank length:

8.8 foot

Tank Width:

5.3 foot

Tank Depth:

5.0 foot

Total Void Volume:

1,734 Gallons

Recirculation Tank Effective Volume = L * W * Lowest Invert To Tank Bottom:

Tank length:

8.8 foot

Tank Width:

5.3 foot

Lowest Invert To Tank Bottom:

4.1 foot

Effective Volume: 1,416 Gallons

Recirculation Pump Float Setting:

Total Tank Depth 60.0 Inches
Tank Gallons Per Inch 28.9 Gal/inch
Pump Off (From Tank Bottom to Pump Off): 18 Inches
Pump Enable (From Tank Bottom to Pump Enable): 22 Inches
High Water Alarm (From Tank Bottom to Alarm): 50 Inches
Secondary Timer (From Tank Bottom to Secondary Timer): 51 Inches

FIELD DOSING TANK SIZING:

Field Dosing Tank Size Required: 1,731 Gallons per 15A NCAC 18A .1952 (c)
Field Dosing Tank Size Provided: 2,000 Gallons

Field Dosing Tank Capacity calculations:

Field Dosing Tank Total Void Volume= L * W * D:

Tank length: 12.9 foot
Tank Width: 5.5 foot
Tank Depth: 3.8 foot
Total Liquid Capacity: 2,037 Gallons

Field Dosing Pump Float Setting:

Total Tank Depth 46.0 Inches
Tank Gallons Per Inch 44.3 Gal/inch
Pump Off (From Tank Bottom to Pump Off): 22 Inches
Pump On (From Tank Bottom to Pump On): 29 Inches
High Water Alarm (From Tank Bottom to Alarm): 32 Inches

MacConnell & Associates, P.C.

Project: Ziad Qudwa Custom Exempt Slaughterhouse
 Project Number: A67601.00
 Location: Harnett County
 Subject: E-Z Treat Treatment Calculations
 Date: December 5, 2018

Assumptions And Calculations:

Notes:
 Input
 Calculated

Maximum Design Flow: 1836.3 GPD

Table 1: Summary of plant and raw waste characteristics for a simple slaughterhouse (EPA).

Base	Flow 1/1000 kg LWK	Kill 1000 LWK/day	BOD5 kg/1000 kg LWK	Suspended Solids kg/1000 kg LWK	Grease kg/1000 kg LWK	Kjeldahl Nitrogen as N kg/1000 kg LWK
Facilities Studied	24	24	24	22	12	5
Average	N.A	N.A	6	5.6	2.1	0.68
Range	1,334-14,641	N.A	1.5-14.3	0.6-12.9	0.24-7.0	0.23-1.36

Estimated Slaughter Operation

Livestock	Chicken	Sheep/Goat	Veal	
Monday	3	0	0	Livestock
Tuesday	3	1	0	Livestock
Wednesday	5	1	0	Livestock
Thursday	5	1	0	Livestock
Friday	5	3	0	Livestock
Saturday	15	3	1	Livestock
Sunday	15	3	0	Livestock
Livestocks/Week	51	12	1	Livestock

Water Usage per Livestock

	Average Weight/Kill (lbs)	Average Water Usage (Gal/1,000 lbs)
Chicken	3.83	2428
Sheep/Goat	350	400
Cattle/calve	2400	532

* Values are obtained from EPA and USDA design manual

Estimated Total Weight Processed in lbs

Livestock	Chicken	Sheep/Goat	Veal	
Monday	11	-	-	lbs
Tuesday	11	350	-	lbs
Wednesday	19	350	-	lbs
Thursday	19	350	-	lbs
Friday	19	1,050	-	lbs
Saturday	57	1,050	2,400	lbs
Sunday	57	1,050	-	lbs
Livestock/Week	195	4,200	2,400	lbs

Estimated Slaughter Weights in kg

Livestock	Chicken	Sheep/Goat	Veal	Total	
Monday	5	-	-	5	kg
Tuesday	5	159	-	164	kg
Wednesday	9	159	-	168	kg
Thursday	9	159	-	168	kg
Friday	9	477	-	486	kg
Saturday	26	477	1,091	1,594	kg
Sunday	26	477	-	503	kg
Livestock/Week	89	1,909	1,091	3,089	kg

Influent Characteristics From Table 1

BOD (5-Day):	6.00 kg/1000 kg LWK
TSS:	5.60 kg/1000 kg LWK
FOG:	2.10 kg/1000 kg LWK
TKN:	0.46 kg/1000 kg LWK

Estimated Pollutants Generated in Kg

Livestock	BOD5	TSS	FOG	TKN	
Monday	0.031	0.029	0.011	0.002	kg
Tuesday	0.986	0.920	0.345	0.076	kg
Wednesday	1.007	0.940	0.352	0.077	kg
Thursday	1.007	0.940	0.352	0.077	kg
Friday	2.916	2.721	1.021	0.224	kg
Saturday	9.566	8.928	3.348	0.733	kg
Sunday	3.020	2.819	1.057	0.232	kg

Slaughtering Water Usage

	Chicken	Sheep/Goat	Veal	Total Flow	
Monday	28	-	-	28	Gallons
Tuesday	28	140	-	168	Gallons
Wednesday	46	140	-	186	Gallons
Thursday	46	140	-	186	Gallons
Friday	46	420	-	466	Gallons
Saturday	139	420	1,277	1,836	Gallons
Sunday	139	420	-	559	Gallons

Estimated Pollutants Concentrations

Livestock	BOD5	TSS	FOG	TKN	
Monday	297	277	104	23	mg/L
Tuesday	1,553	1,450	544	119	mg/L
Wednesday	1,428	1,333	500	109	mg/L
Thursday	1,428	1,333	500	109	mg/L
Friday	1,654	1,543	579	127	mg/L
Saturday	1,378	1,286	482	106	mg/L
Sunday	1,428	1,333	500	109	mg/L
Weekly Maximum	1,654	1,543	579	127	mg/L

Influent Characteristics:

BOD (5-Day):	1,654 mg/l	
TSS:	1,543 mg/l	
FOG:	579 mg/l	
NH ₃ :	51 mg/l	TKN= N-Organic + NH ₃
N-Organic:	76 mg/l	TKN= N-Organic + NH ₃
TKN:	127 mg/l	TKN= N-Organic + NH ₃
NO ₃ + NO ₂ :	5 mg/l	
TN:	132 mg/l	TKN + NO ₃ + NO ₂
Total Coliforms:	75,000,000 Number	From NSF 350 Approval

Effluent Limits:

Five Day Biochemical Oxygen Demand (BOD5):	≤350	CFR §432.10 - §432.17
Total Suspended Solids (TSS):	≤350 mg/l	CFR §432.10 - §432.18
Fat Oil and Grease (FOG):	≤30	CFR §432.10 - §432.19
Total Nitrogen (TN)	≤134 mg/l	432.13
Fecal Coliform:	≤400 /100 ml	CFR §432.10 - §432.22

Septic Tank:

Design:		
BOD Removal:	50.0 Percent	Given
TSS Removal:	60.0 Percent	Given
FOG Removal:	20.0 Percent	Given
NH ₃ Removal:	0.0 Percent	Given
N-Organic Removal:	35.0 Percent	
N-Organic Converted to NH ₃ :	50.0 Percent	

NO₃ + NO₂ Denitrified: 90.0 Percent
 Total Coliforms Removal: 50.0 Percent

Septic Tank Effluent Concentrations:

BOD (5-Day):	826.8 mg/l	Concentration - Percent Removed
TSS:	617.3 mg/l	Concentration - Percent Removed
FOG:	463.0 mg/l	Concentration - Percent Removed
NH ₃ :	88.7 mg/l	Concentration - Percent Removed + N-Organic Converted to NH ₃
N-Organic:	38.0 mg/l	Concentration - Percent Removed - N-Organic Converted to NH ₃
TKN:	126.8 mg/l	N-Organic + NH ₃
NO ₃ + NO ₂ :	5.0 mg/l	NO ₃ + NO ₂ Effluent + Return from Recirc Tank - Denitrified
TN:	131.8 mg/l	TKN + NO ₃ + NO ₂
E. Coliforms:	37,500,000.0 /100 ml	Concentration - Percent Removed

Grease Trap Tank:

Design:

BOD Removal:	40.0 Percent	Given
TSS Removal:	50.0 Percent	Given
FOG Removal:	70.0 Percent	Given
NH ₃ Removal:	0.0 Percent	Given
N-Organic Removal:	35.0 Percent	
N-Organic Converted to NH ₃ :	50.0 Percent	
NO ₃ + NO ₂ Denitrified:	90.0 Percent	
Total Coliforms Removal:	50.0 Percent	

Grease Trap Tank Effluent Concentrations:

BOD (5-Day):	496.1 mg/l	Concentration - Percent Removed
TSS:	308.7 mg/l	Concentration - Percent Removed
FOG:	138.9 mg/l	Concentration - Percent Removed
NH ₃ :	107.8 mg/l	Concentration - Percent Removed + N-Organic Converted to NH ₃
N-Organic:	19.0 mg/l	Concentration - Percent Removed - N-Organic Converted to NH ₃
TKN:	126.8 mg/l	N-Organic + NH ₃
NO ₃ + NO ₂ :	5.0 mg/l	NO ₃ + NO ₂ Effluent + Return from Recirc Tank - Denitrified
TN:	131.8 mg/l	TKN + NO ₃ + NO ₂
E. Coliforms:	18,750,000.0 /100 ml	Concentration - Percent Removed

Media Filters (K-Z Treat Pod):

BOD Removal:	95.0 Percent	Given
TSS Removal:	95.0 Percent	Given
FOG Removal:	95.0 Percent	Given
NH ₃ Removal (to Air):	2.0 Percent	Given
NH ₃ Nitrified to NO ₃ + NO ₂ :	95.0 Percent	Given
N-Organic Converted to NH ₃ :	95.0 Percent	
NO ₃ + NO ₂ to Septic for Denitrification:	90.0 Percent	
E. Coliforms Removal:	50.0 Percent	

E-Z Treat/Re-Circ. Tank Effluent Concentrations:

BOD (5-Day):	24.80 mg/l	Concentration - Percent Removed
TSS:	15.43 mg/l	Concentration - Percent Removed
FOG:	6.95 mg/l	Concentration - Percent Removed
NH ₃ :	105.60 mg/l	Concentration - Percent Removed + (S.T. Conc. + (N-Organic to NH ₃))
N-Organic:	1.90 mg/l	Concentration -N-Organic Converted to NH ₃
TKN:	107.51 mg/l	N-Organic + NH ₃
NO ₃ + NO ₂ :	4.47 mg/l	NO ₃ + NO ₂ S.T. Effluent + Nitrified NH ₃ - Return to Septic Tank
TN:	111.97 mg/l	TKN + NO ₃ + NO ₂
Total Coliforms:	18,750,000.0 /100 ml	Concentration - Percent Removed

Ultraviolet Disinfection:

Design

UV Dosing Rate:	10.0 gpm	Flow Rate
Number of Units:	1 Units	Pump Flow/Dosing Rate
BOD Removal:	0.00 Percent	Given
TSS Removal:	0.00 Percent	Given
FOG Removal:	0.00	Given
NH ₃ Removal:	0.00 Percent	Given
N-Organic Removal:	0.00 Percent	Given
NO ₃ + NO ₂ Removal:	0.00 Percent	
Total Coliforms Removal:	99.999000000 Percent	

Ultraviolet Disinfection Effluent Concentrations:

BOD (5-Day):	24.80 mg/l
TSS:	15.43 mg/l
FOG:	6.95 mg/l
NH ₃ :	105.60 mg/l
N-Organic:	1.90 mg/l
TKN:	107.51 mg/l
NO ₃ + NO ₂ :	4.47 mg/l
TN:	111.97 mg/l
Total Coliforms:	187.50 /100 ml
Fecal Coliforms:	< 187.50 /100 ml

Concentration - Percent Removed
Concentration - Percent Removed
Concentration - Percent Removed
Concentration - Percent Removed + (S.T. Conc. + (N-Organic to NH₃
Concentration -N-Organic Converted to NH₃
N-Organic + NH₃
NO₃ + NO₂ S.T. Effluent + Nitrified NH₃ - Return to Septic Tank
TKN + NO₃ + NO₂
Concentration - Percent Removed
Fecal Coliforms < Total Coliforms < 200 colonies/100ml = Okay

MACCONNELL AND ASSOCIATES, P.C.

PRESSURE MANIFOLD DESIGN - INITIAL

Name: Custom Exempt Slaughterhouse P.I.N. #: 0664-69-9440.000 D#: N/A
 Address: 1253 Atkins Rd, Fuquay-Varina, NC Subdiv: N/A Lot#: N/A
 # of BDR: N/A Daily Flow: 615 gal/day L.T.A.R.: 0.40 gal/day/sq.ft

Septic Tank: 2000 gals Pump Tank: 2000 gals Sq. Foot: 1215 Stone Depth: N/A

Number of Taps: 6 Length of Trenches: 405 ft(See Tap Chart for Details)

Depth of Trenches: 18 in Manifold Length: 54 in

Manifold Diameter: 4inch Tap Configuration: 1/2 in spacing 1 side(s) of manifold

Supply Line length: 500 ft Diameter(Supply Line): 2 in sch 40 pvc

Friction Loss + Fitting Loss: 14.94 ft(supply line length + 70' for fittings in pump tank)

Design Head: 2 ft Elevation Head: 8.00 ft

Total Head: 24.94 ft Pump to Deliver: 33.92 gals/min at 24.94 ft head

Dosing Volume: 185 gals,

Pump Selection: Drawdown: 185 gals divided by 44.30 gals/in = 4.2 inches head

Pump Selection: As shown on the construction drawings

TAP CHART

Bench Mark		Bench mark elev.		Pump elev.		Design Head:			
Pump tank elev.		311.40		316.00		Manifold elev.	324.00		
line	color	rod read	Elevation	length	hole size	flow/tap	gal/day	trench area	LINE LTAR
1	Pink	0.0	316.00	65	1/2in SCH 40	5.43	99.36	195	0.51
2	Red	0.4	315.60	80	1/2in SCH 40	7.11	128.91	240	0.53
3	Blue	1.0	315.00	80	1/2in SCH 40	7.11	128.91	240	0.53
4	Yellow	1.5	314.50	90	1/2in SCH 40	7.11	128.91	270	0.48
5	Orange	2.1	313.90	90	1/2in SCH 40	7.11	128.91	270	0.48
		total	feet =	405	gal/min =	33.92			LTAR =
		70.00%			Des. Flow	615			(ltar + 5%)
		185			Pump Run-	18.33			(ltar W/ INOV)
		5.43			Tank Gal/IN	44.30			(ltar + 5%)
		4.2			Elev. Head	8.00			0.56
		500							

Hydraulic Profile

Manifold Elevation	324.00	319.50
Pump tank elev.	311.40	320.00
Pump elev.	316.00	320.50
		321.00
		321.50

MACCONNELL AND ASSOCIATES, P.C.

PRESSURE MANIFOLD DESIGN - REPAIR

Name: Custom Exempt Slaughterhouse P.I.N. #: 0664-69-9440.000 D#: N/A

Address: 1253 Atkins Rd. Fuquay-Varina, NC Subdiv: N/A Lot#: N/A

of BDR: N/A Daily Flow: 615 gal/day L.T.A.R.: 0.40 gal/day/sq.ft

Septic Tank: 2000 gals Pump Tank: 2000 gals Sq. Foot: 1350 Stone Depth: N/A

Number of Taps: 6 Length of Trenches: 450 ft(See Tap Chart for Details)

Depth of Trenches: 18 in Manifold Length: 54 in

Manifold Diameter: 4inch Tap Configuration: 1/2 in spacing 1 side(s) of manifold

Supply Line: length: 500 ft Diameter(Supply Line): 2 in sch 40 pvc

Friction Loss + Fitting Loss: 16.29 ft(supply line length + 70' for fittings in pump tank)

Design Head: 2 ft Elevation Head: 8.00 ft

Total Head: 26.29 ft Pump to Deliver: 35.55 gals/min at 26.29 ft head

Dosing Volume: 206 gals,

Pump Selection: Drawdown: 206 gals divided by 44.30 gals/in = 4.6 inches head

Pump Selection: As shown on the construction drawings

TAP CHART

Bench Mark	0	Bench mark elev.		Pump elev.	316	Design Head:	2		
Pump tank elev.	311.4	316.00	Pump elev.	316	Manifold elev.	324.00			
line	color	rod read	Elevation	length	hole size	flow/tap	gal/day	trench area	LINE LTAR
6	White	2.7	313.3	90	1/2m SCH 40	7.11	123.00	270	0.46
7	Pink	3.4	312.6	90	1/2m SCH 40	7.11	123.00	270	0.46
8	Red	4.0	312.0	90	1/2m SCH 40	7.11	123.00	270	0.46
9	Blue	4.6	311.4	90	1/2m SCH 40	7.11	123.00	270	0.46
10	Yellow	5.2	310.8	90	1/2m SCH 40	7.11	123.00	270	0.46
		total	feet =	450	gal/min =	35.55		LTAR =	0.40
% of Dose Vol.		70.00%		Des. Flow	615			(tar + 5%)	0.42
Dose Volume		206		Pump Run-	17.30			(tar W/ INOV)	0.53
Dose Pump Time		5.76		Tank Gal/IN	44.30			(tar + 5%)	0.56
Drawdown in Inches		4.6		Elev. Head	8.00				
Supply Line Length		500							
Comments:									

Hydraulic Profile

Manifold Elevation	324.00
Pump tank elev.	311.40
Pump elev.	316.00

Septic Tank (3160 ST H20 -419)

Dimensions		
Lid Thickness (L)	0.33	(feet)
Lid Hole Diameter (H1)	24.00	(inches)
Lid Hole Diameter (H2) - If tank has only one hole, leave blank.	24.00	(inches)
Lid Hole Diameter (H3) - If tank has only one hole, leave blank.	0.00	(inches)
Length of Tank (A)	13.92	(feet)
Width of Tank (B)	6.50	(feet)
Height of Tank Excluding Lid (C) - This value includes the base thickness but excludes the lid thickness.	7.42	(feet)
Depth of Bury (Y) - This measurement extends from the ground level to the top of the lid.	1.50	(feet)
Wall Thickness (T)	0.50	(feet)
Base Thickness (E)	0.58	(feet)
Distance to Groundwater (GW)	2.50	(feet)

Ballast		
Add Concrete Inside the Tank		
Initial Inside Height of Tank - This measurement is the value of C - E.	6.83	(feet)
Add concrete inside the tank to make thicker base? If yes, how much? (U) If no, enter a value of 0. Please note: The value entered must be less than the inside height of the tank.	0.00	(feet)
Increase Thickness of the Base		
Initial Base Thickness - This measurement is the value of E.	0.58	(feet)
Add concrete below the base of the tank to make thicker base? If yes, how much? (F) If no, enter a value of 0.	0.00	(feet)
Create Lip:		
Extend the base horizontally to create a lip? - The lip will be the thickness of E plus F, below, and it will extend this horizontal distance, P, from all four tank walls. If yes, how much? (P) If no, enter a value of 0.	0.00	(feet)

Summary of Final Measurements after Ballast Customizations		
Final Base Thickness - This measurement is the sum of E and F.	0.58	(feet)
Lip Thickness - This measurement is the sum of E and F.	0.58	(feet)

Total Height of the Tank from the Top of the Lid to the Bottom of the Base - This measurement is the sum of L, C, and F. This is equivalent to the sum of L, C - E, E, and F.	7.75	(feet)
Final Inside Height of Tank - This measurement is the value of C - E - U.	6.83	(feet)
Final Volume of Tank	485.45	(cf)
Final Volume of Tank	3631.43	(gallons)

Unit Weight of Water	62.40	(lb/cf)
Unit Weight of Dry Soil	110.00	(lb/cf)
Unit Weight of Submerged Soil	47.60	(lb/cf)
Unit Weight of Saturated Soil	120.00	(lb/cf)
Unit Weight of Concrete	150.00	(lb/cf)

Changes in Total Concrete Weight Due to Customizations		
Weight of extra concrete inside tank used to create thicker base (Weight of extra concrete due to U)	0	(lb)
Weight of extra concrete on bottom of tank used to create thicker base (Weight of extra concrete due to F)	0	(lb)
Weight of extra concrete due to lip (Weight of extra concrete due to P)	0	(lb)
Weight of concrete removed due to lid hole	311	(lb)

Weight of Soil on Lid	14926	(lb)
Weight of Soil on Lip	0	(lb)
Weight of Lid Alone	4167	(lb)
Weight of Empty Tank - This value is the sum of weights of the body of the tank, the tank lid, the lip (P, if applicable), the thickened base (F, if applicable), and the extra concrete inside tank (U, if applicable), minus the weight of the concrete removed due to the hole in the lid.	31984	(lb)

Water in Tank		
Water Level in Tank - Please note: The value entered must be less than the final inside height of the tank.	0.00	(feet)
Weight of Water in Tank	0	(lb)

Weight of System Components		
Total Weight of Soil on Tank	14926	(lb)
Total Weight of Concrete	31984	(lb)
Total Weight (Tank, Water in Tank, and Soil)	46909	(lb)

Sliding Resistance		
Specific Gravity of Soil, SG	2.75	
Friction Factor (Found in Table 1), f	0.30	
Void Ratio (Found in Table 3), e	0.85	
Ratio of Lateral to Vertical Earth Pressure (Found in Table 2), Ka	0.33	
Sliding Resistance	34377	(lb)

Uplift		
Uplift Force	38082.23	(lb)
Safety Factor	1.00	
Uplift Force with Safety Factor	38082.23	(lb)

Additional Ballast Required		
Additional Ballast Required	NONE	(lb)

Grease Trap Tank (2000 GT)

Basic Dimensions		
Lid Thickness (L)	0.33	(feet)
Lid Hole Diameter (H1)	24.00	(inches)
Lid Hole Diameter (H2) - If tank has only one hole, leave blank.	24.00	(inches)
Lid Hole Diameter (H3) - If tank has only one hole, leave blank.	0.00	(inches)
Length of Tank (A)	13.92	(feet)
Width of Tank (B)	6.50	(feet)
Height of Tank Excluding Lid (C) - This value includes the base thickness but excludes the lid thickness.	5.25	(feet)
Depth of Bury (Y) - This measurement extends from the ground level to the top of the lid.	1.60	(feet)
Wall Thickness (T)	0.50	(feet)
Base Thickness (E)	0.58	(feet)
Distance to Groundwater (GW)	2.50	(feet)

Customizations after Ballast		
Add Concrete Inside the Tank:		
Initial Inside Height of Tank - This measurement is the value of C - E.	4.67	(feet)
Add concrete inside the tank to make thicker base? If yes, how much? (U) If no, enter a value of 0. Please note: The value entered must be less than the inside height of the tank.	0.00	(feet)
Increase Thickness of the Base:		
Initial Base Thickness - This measurement is the value of E.	0.58	(feet)
Add concrete below the base of the tank to make thicker base? If yes, how much? (F) If no, enter a value of 0.	0.00	(feet)
Create Lip:		
Extend the base horizontally to create a lip? - The lip will be the thickness of E plus F, below, and it will extend this horizontal distance, P, from all four tank walls. If yes, how much? (P) If no, enter a value of 0.	0.00	(feet)

Summary of Final Measurements after Ballast Customizations		
Final Base Thickness - This measurement is the sum of E and F.	0.58	(feet)
Lip Thickness - This measurement is the sum of E and F.	0.58	(feet)

Total Height of the Tank from the Top of the Lid to the Bottom of the Base - This measurement is the sum of L, C, and F. This is equivalent to the sum of L, C - E, E, and F.	5.58	(feet)
Final Inside Height of Tank - This measurement is the value of C - E - U.	4.67	(feet)
Final Volume of Tank	331.53	(cf)
Final Volume of Tank	2480.00	(gallons)

Unit Weights		
Unit Weight of Water	62.40	(lb/cf)
Unit Weight of Dry Soil	110.00	(lb/cf)
Unit Weight of Submerged Soil	47.60	(lb/cf)
Unit Weight of Saturated Soil	120.00	(lb/cf)
Unit Weight of Concrete	150.00	(lb/cf)

Changes in Total Concrete Weight Due to Customizations		
Weight of extra concrete inside tank used to create thicker base (Weight of extra concrete due to U)	0	(lb)
Weight of extra concrete on bottom of tank used to create thicker base (Weight of extra concrete due to F)	0	(lb)
Weight of extra concrete due to lip (Weight of extra concrete due to P)	0	(lb)
Weight of concrete removed due to lid hole	311	(lb)

Weights of Tank Components		
Weight of Soil on Lid	14926	(lb)
Weight of Soil on Lip	0	(lb)
Weight of Lid Alone	4167	(lb)
Weight of Empty Tank - This value is the sum of weights of the body of the tank, the tank lid, the lip (P, if applicable), the thickened base (F, if applicable), and the extra concrete inside tank (U, if applicable), minus the weight of the concrete removed due to the hole in the lid.	25673	(lb)

Water in Tank		
Water Level in Tank - Please note: The value entered must be less than the final inside height of the tank.	0.00	(feet)
Weight of Water in Tank	0	(lb)

Weight of System Components		
Total Weight of Soil on Tank	14926	(lb)
Total Weight of Concrete	25673	(lb)
Total Weight (Tank, Water in Tank, and Soil)	40599	(lb)

Sliding Resistance		
Specific Gravity of Soil, SG	2.75	
Friction Factor (Found in Table 1), f	0.30	
Void Ratio (Found in Table 3), e	0.85	
Ratio of Lateral to Vertical Earth Pressure (Found in Table 2), Ka	0.33	
Sliding Resistance	19118	(lb)

Uplift Force	25852.27	(lb)
Safety Factor	1.00	
Uplift Force with Safety Factor	25852.27	(lb)

Additional Ballast Required	NONE	(lb)
------------------------------------	-------------	-------------

Equalization Tank (4500 PT H20-506)

Basic Dimensions		
Lid Thickness (L)	0.33	(feet)
Lid Hole Diameter (H1)	24.00	(inches)
Lid Hole Diameter (H2) - If tank has only one hole, leave blank.	24.00	(inches)
Lid Hole Diameter (H3) - If tank has only one hole, leave blank.	0.00	(inches)
Length of Tank (A)	13.92	(feet)
Width of Tank (B)	6.50	(feet)
Height of Tank Excluding Lid (C) - This value includes the base thickness but excludes the lid thickness.	9.08	(feet)
Depth of Bury (Y) - This measurement extends from the ground level to the top of the lid.	1.50	(feet)
Wall Thickness (T)	0.50	(feet)
Base Thickness (E)	0.58	(feet)
Distance to Groundwater (GW)	2.50	(feet)

Information to Adjust		
Add Concrete Inside the Tank:		
Initial Inside Height of Tank - This measurement is the value of C - E.	8.50	(feet)
Add concrete inside the tank to make thicker base?	0.00	(feet)
If yes, how much? (U) If no, enter a value of 0. Please note: The value entered must be less than the inside height of the tank.		
Increase Thickness of the Base:		
Initial Base Thickness - This measurement is the value of E.	0.58	(feet)
Add concrete below the base of the tank to make thicker base?	0.00	(feet)
If yes, how much? (F) If no, enter a value of 0.		
Create Lip:		
Extend the base horizontally to create a lip? - The lip will be the thickness of E plus F, below, and it will extend this horizontal distance, P, from all four tank walls.	0.00	(feet)
If yes, how much? (P) If no, enter a value of 0.		

Summary of Final Measurements after Ballast Customizations		
Final Base Thickness - This measurement is the sum of E and F.	0.58	(feet)
Lip Thickness - This measurement is the sum of E and F.	0.58	(feet)

Total Height of the Tank from the Top of the Lid to the Bottom of the Base - This measurement is the sum of L, C, and F. This is equivalent to the sum of L, C - E, E, and F.	9.41	(feet)
Final Inside Height of Tank - This measurement is the value of C - E - U.	8.50	(feet)
Final Volume of Tank	603.85	(cf)
Final Volume of Tank	4517.14	(gallons)

Unit Weights		
Unit Weight of Water	62.40	(lb/cf)
Unit Weight of Dry Soil	110.00	(lb/cf)
Unit Weight of Submerged Soil	47.60	(lb/cf)
Unit Weight of Saturated Soil	120.00	(lb/cf)
Unit Weight of Concrete	150.00	(lb/cf)

Changes in Total Concrete Weight Due to Customizations		
Weight of extra concrete inside tank used to create thicker base (Weight of extra concrete due to U)	0	(lb)
Weight of extra concrete on bottom of tank used to create thicker base (Weight of extra concrete due to F)	0	(lb)
Weight of extra concrete due to lip (Weight of extra concrete due to P)	0	(lb)
Weight of concrete removed due to lid hole	311	(lb)

Soil and Concrete Weights		
Weight of Soil on Lid	14926	(lb)
Weight of Soil on Lip	0	(lb)
Weight of Lid Alone	4167	(lb)
Weight of Empty Tank - This value is the sum of weights of the body of the tank, the tank lid, the lip (P, if applicable), the thickened base (F, if applicable), and the extra concrete inside tank (U, if applicable), minus the weight of the concrete removed due to the hole in the lid.	36838	(lb)

Water in Tank		
Water Level in Tank - Please note: The value entered must be less than the final inside height of the tank.	0.00	(feet)
Weight of Water in Tank	0	(lb)

Weight of System Components		
Total Weight of Soil on Tank	14926	(lb)
Total Weight of Concrete	36838	(lb)
Total Weight (Tank, Water in Tank, and Soil)	51764	(lb)

Sliding Resistance		
Specific Gravity of Soil, SG	2.75	
Friction Factor (Found in Table 1), f	0.30	
Void Ratio (Found in Table 3), e	0.85	
Ratio of Lateral to Vertical Earth Pressure (Found in Table 2), Ka	0.33	
Sliding Resistance	49172	(lb)

Uplift		
Uplift Force	47489.90	(lb)
Safety Factor	1.00	
Uplift Force with Safety Factor	47489.90	(lb)

Additional Ballast Required		
Additional Ballast Required	NONE	(lb)

Recirculation Tank (1850 PT H20-366)

Basic Dimensions		
Lid Thickness (L)	0.33	(feet)
Lid Hole Diameter (H1)	24.00	(inches)
Lid Hole Diameter (H2) - If tank has only one hole, leave blank.	24.00	(inches)
Lid Hole Diameter (H3) - If tank has only one hole, leave blank.	0.00	(inches)
Length of Tank (A)	10.08	(feet)
Width of Tank (B)	6.50	(feet)
Height of Tank Excluding Lid (C) - This value includes the base thickness but excludes the lid thickness.	5.58	(feet)
Depth of Bury (Y) - This measurement extends from the ground level to the top of the lid.	1.50	(feet)
Wall Thickness (T)	0.50	(feet)
Base Thickness (E)	0.67	(feet)
Distance to Groundwater (GW)	2.50	(feet)

Add Concrete to Tank Ballast		
Add Concrete Inside the Tank:		
Initial Inside Height of Tank - This measurement is the value of C - E.	4.92	(feet)
Add concrete inside the tank to make thicker base? If yes, how much? (U) If no, enter a value of 0. Please note: The value entered must be less than the inside height of the tank.	0.00	(feet)
Increase Thickness of the Base:		
Initial Base Thickness - This measurement is the value of E.	0.67	(feet)
Add concrete below the base of the tank to make thicker base? If yes, how much? (F) If no, enter a value of 0.	0.00	(feet)
Create Lip:		
Extend the base horizontally to create a lip? - The lip will be the thickness of E plus F, below, and it will extend this horizontal distance, P, from all four tank walls. If yes, how much? (P) If no, enter a value of 0.	0.00	(feet)

Summary of Final Measurements after Ballast		
Customizations		
Final Base Thickness - This measurement is the sum of E and F.	0.67	(feet)
Lip Thickness - This measurement is the sum of E and F.	0.67	(feet)

Total Height of the Tank from the Top of the Lid to the Bottom of the Base - This measurement is the sum of L, C, and F. This is equivalent to the sum of L, C - E, E, and F.	5.91	(feet)
Final Inside Height of Tank - This measurement is the value of C - E - U.	4.92	(feet)
Final Volume of Tank	245.63	(cf)
Final Volume of Tank	1837.43	(gallons)

Unit Weights		
Unit Weight of Water	62.40	(lb/cf)
Unit Weight of Dry Soil	110.00	(lb/cf)
Unit Weight of Submerged Soil	47.60	(lb/cf)
Unit Weight of Saturated Soil	120.00	(lb/cf)
Unit Weight of Concrete	150.00	(lb/cf)

Changes in Total Concrete Weight Due to Customizations		
Weight of extra concrete inside tank used to create thicker base (Weight of extra concrete due to U)	0	(lb)
Weight of extra concrete on bottom of tank used to create thicker base (Weight of extra concrete due to F)	0	(lb)
Weight of extra concrete due to lip (Weight of extra concrete due to P)	0	(lb)
Weight of concrete removed due to lid hole	311	(lb)

Soil and Lid Weights		
Weight of Soil on Lid	10814	(lb)
Weight of Soil on Lip	0	(lb)
Weight of Lid Alone	2933	(lb)
Weight of Empty Tank - This value is the sum of weights of the body of the tank, the tank lid, the lip (P, if applicable), the thickened base (F, if applicable), and the extra concrete inside tank (U, if applicable), minus the weight of the concrete removed due to the hole in the lid.	20980	(lb)

Water in Tank		
Water Level in Tank - Please note: The value entered must be less than the final inside height of the tank.	0.00	(feet)
Weight of Water in Tank	0	(lb)

Weight of System Components		
Total Weight of Soil on Tank	10814	(lb)
Total Weight of Concrete	20980	(lb)
Total Weight (Tank, Water in Tank, and Soil)	31795	(lb)

Sliding Resistance		
Specific Gravity of Soil, SG	2.75	
Friction Factor (Found in Table 1), f	0.30	
Void Ratio (Found in Table 3), e	0.85	
Ratio of Lateral to Vertical Earth Pressure (Found in Table 2), Ka	0.33	
Sliding Resistance	17198	(lb)

Uplift Force		
Uplift Force	20094.55	(lb)
Safety Factor	1.00	
Uplift Force with Safety Factor	20094.55	(lb)

Additional Ballast Required		
Additional Ballast Required	NONE	(lb)

Field Dosing Tank (2000 PT H20-386)

Basic Dimensions		
Lid Thickness (L)	0.33	(feet)
Lid Hole Diameter (H1)	24.00	(inches)
Lid Hole Diameter (H2) - If tank has only one hole, leave blank.	24.00	(inches)
Lid Hole Diameter (H3) - If tank has only one hole, leave blank.	0.00	(inches)
Length of Tank (A)	13.92	(feet)
Width of Tank (B)	6.50	(feet)
Height of Tank Excluding Lid (C) - This value includes the base thickness but excludes the lid thickness.	4.42	(feet)
Depth of Bury (Y) - This measurement extends from the ground level to the top of the lid.	1.50	(feet)
Wall Thickness (T)	0.50	(feet)
Base Thickness (E)	0.58	(feet)
Distance to Groundwater (GW)	2.50	(feet)

Customizations to Add Ballast		
Add Concrete Inside the Tank:		
Initial Inside Height of Tank - This measurement is the value of C - E.	3.83	(feet)
Add concrete inside the tank to make thicker base?	0.00	(feet)
If yes, how much? (U) If no, enter a value of 0. Please note: The value entered must be less than the inside height of the tank.		
Increase Thickness of the Base:		
Initial Base Thickness - This measurement is the value of E.	0.58	(feet)
Add concrete below the base of the tank to make thicker base?	0.00	(feet)
If yes, how much? (F) If no, enter a value of 0.		
Create Lip:		
Extend the base horizontally to create a lip? - The lip will be the thickness of E plus F, below, and it will extend this horizontal distance, P, from all four tank walls.	0.00	(feet)
If yes, how much? (P) If no, enter a value of 0.		

Summary of Final Measurements after Ballast		
Customizations		
Final Base Thickness - This measurement is the sum of E and F.	0.58	(feet)
Lip Thickness - This measurement is the sum of E and F.	0.58	(feet)

Total Height of the Tank from the Top of the Lid to the Bottom of the Base - This measurement is the sum of L, C, and F. This is equivalent to the sum of L, C - E, E, and F.	4.75	(feet)
Final Inside Height of Tank - This measurement is the value of C - E - U.	3.83	(feet)
Final Volume of Tank	272.33	(cf)
Final Volume of Tank	2037.14	(gallons)

Final Weights		
Unit Weight of Water	62.40	(lb/cf)
Unit Weight of Dry Soil	110.00	(lb/cf)
Unit Weight of Submerged Soil	47.60	(lb/cf)
Unit Weight of Saturated Soil	120.00	(lb/cf)
Unit Weight of Concrete	150.00	(lb/cf)

Changes in Total Concrete Weight Due to Customizations		
Weight of extra concrete inside tank used to create thicker base (Weight of extra concrete due to U)	0	(lb)
Weight of extra concrete on bottom of tank used to create thicker base (Weight of extra concrete due to F)	0	(lb)
Weight of extra concrete due to lip (Weight of extra concrete due to P)	0	(lb)
Weight of concrete removed due to lid hole	311	(lb)

Soil and Lid Weights		
Weight of Soil on Lid	14926	(lb)
Weight of Soil on Lip	0	(lb)
Weight of Lid Alone	4167	(lb)
Weight of Empty Tank - This value is the sum of weights of the body of the tank, the tank lid, the lip (P, if applicable), the thickened base (F, if applicable), and the extra concrete inside tank (U, if applicable), minus the weight of the concrete removed due to the hole in the lid.	23246	(lb)

Water in Tank		
Water Level in Tank - Please note: The value entered must be less than the final inside height of the tank.	0.00	(feet)
Weight of Water in Tank	0	(lb)

Weight of System Components		
Total Weight of Soil on Tank	14926	(lb)
Total Weight of Concrete	23246	(lb)
Total Weight (Tank, Water in Tank, and Soil)	38172	(lb)

Sliding Resistance		
Specific Gravity of Soil, SG	2.75	
Friction Factor (Found in Table 1), f	0.30	
Void Ratio (Found in Table 3), e	0.85	
Ratio of Lateral to Vertical Earth Pressure (Found in Table 2), Ka	0.33	
Sliding Resistance	14445	(lb)

Uplift Force		
Uplift Force	21148.43	(lb)
Safety Factor	1.00	
Uplift Force with Safety Factor	21148.43	(lb)

Additional Ballast Required		
Additional Ballast Required	NONE	(lb)

Subject: E-Z Treat Pod Flotation

Uplift Calculations

Pod Length =	7.75	ft.
Pod Width =	7.75	ft.
Pod Height =	3.00	ft.
Natural Soil Depth (for Flotation) =	0.50	ft.
Fill Soil Depth (for Ballast) =	2.50	ft.
5/4 Trex Board Length =	8.00	ft.
5/4 Trex Board Width =	0.46	ft.
5/4 Trex Board Thickness =	0.09	ft.
Number of Boards =	4	

Assume the following densities:

5/4 Trex Board =	60	# / Cu. Ft.
Water =	62.4	# / Cu. Ft.
Soil =	100	# / Cu. Ft.

Determine Upward Forces:

Pod Area =	60.06	sq. ft.
Pod Buried Volume =	30.03	cu. ft.
5/4 Trex Board Area =	14.67	sq. ft.
5/4 Trex Board Volume =	1.34	cu. ft.
Soil Area Over 5/4 Trex Board =	14.67	sq. ft.
Soil Volume Over 5/4 Trex Board =	7.33	cu. ft.

Total Buoyant Force of Basin =	1,874	#
--------------------------------	-------	---

Total Buoyant Force of Trex Board =	84	#
-------------------------------------	----	---

Total Buoyant Force of Soil =	458	#
-------------------------------	-----	---

Total Upward Forces =	2,415	#
-----------------------	-------	---

Determine Downward Forces:

5/4 Trex Board Area =	14.67	sq. ft.
5/4 Trex Board Volume =	1.34	cu. ft.
Soil Area Over 5/4 Trex Board =	14.67	sq. ft.
Soil Volume Over 5/4 Trex Board =	36.67	cu. ft.

Total Weight of Trex Board =	81	#
------------------------------	----	---

Total Weight of Soil =	3,667	#
------------------------	-------	---

Total Downward Forces =	3,747	#
-------------------------	-------	---

Factor of safety =	$\frac{\text{Total Downward} = 1.55}{\text{Total Upward} =}$
	1.55 > 1.00 = OK

*Weight of pod, mattress, and piping are not counted in downward forces.

Subject: E-Z Treat UV Basin Flotation

Uplift Calculations

Basin Diameter = 2.50 ft.
Basin Height = 4.00 ft.
Soil Depth = 3.50 ft.

Concrete Slab Length = 4.00 ft.
Concrete Slab Width = 4.00 ft.
Concrete Slab Thickness = 0.50 ft.

Assume the following densities:

Concrete = 150 # / cu. Ft.
Water = 62.4 # / cu. Ft.
Soil = 100 # / cu. Ft.

Determine Upward Forces:

Basin Area = 4.91 sq. ft.
Basin Buried Volume = 17.18 cu. ft.

Concrete Area = 16.00 sq. ft.
Concrete Volume = 8.00 cu. ft.

Soil Area Over Concrete = 11.09 sq. ft.
Soil Volume Over Concrete = 38.82 cu. ft.

Total Buoyant Force of Basin = 1,072 #

Total Buoyant Force of Concrete = 499 #

Total Buoyant Force of Soil = 2,422 #

Total Upward Forces = 3,994 #

Determine Downward Forces:

Concrete Area = 16.00 sq. ft.
Concrete Volume = 8.00 cu. ft.

Soil Area Over Concrete = 11.09 sq. ft.
Soil Volume Over Concrete = 38.82 cu. ft.

Total Weight of Concrete = 1,200 #

Total Weight of Soil = 3,882 #

Total Downward Forces = 5,082 #

Factor of safety = $\frac{\text{Total Downward}}{\text{Total Upward}} = 1.27$

1.27 > 1.00 = OK

Ziad Qudwa
Custom Exempt Slaughterhouse On-Site System

Equipment

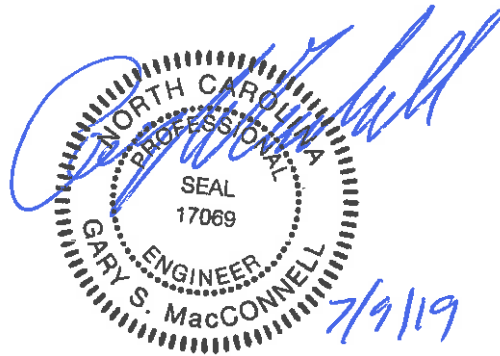

MacConnell & Associates, P.C.
1101 Nowell, Road, Suite 118
Raleigh, North Carolina 27607

P.O. Box 129
Morrisville, North Carolina 27560

Phone: (919) 467-1239
Fax: (919) 319-6510



GEOSYNTHETIC AGGREGATE TECHNOLOGY

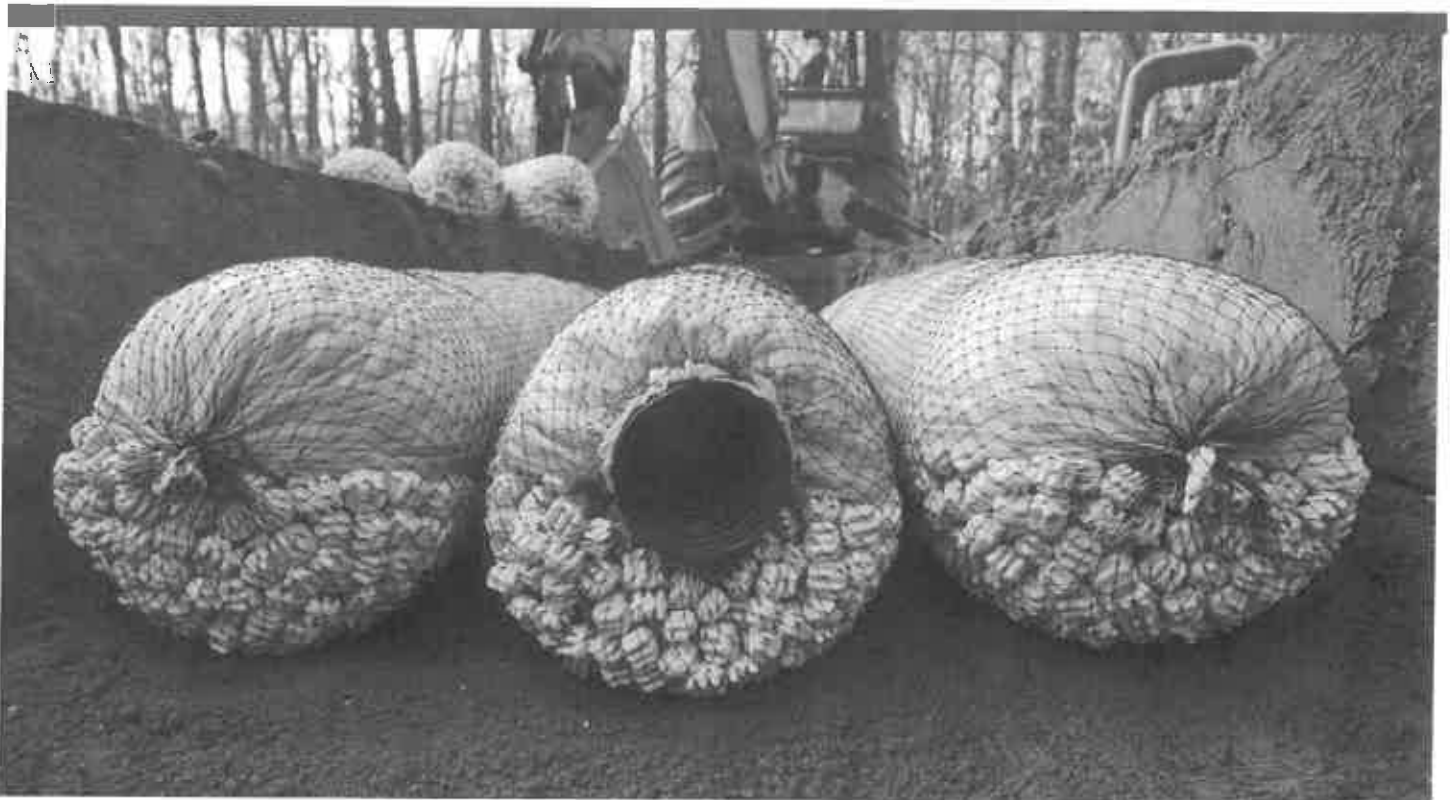

EZflow by Infiltrator is an environmentally friendly replacement to traditional stone and pipe drainfields using an engineered geosynthetic aggregate modular design. The EZflow system is designed to improve infiltration performance by eliminating the fines associated with crushed stone, and reducing compaction and embedment associated with stone. Preassembled units include a 3" or 4" perforated pipe surrounded by aggregate and held in place with a durable high-strength netting. This product comes in easy-to-contour 5' and 10' lengths and in diameters of 7, 8, 9, 10, 12, 13, or 14 inches.

Lightweight expanded polystyrene

construction offers structural integrity and resists compaction. Engineered flow-channels increase void space creating improved water flow and greater storage.



INFILTRATOR®
water technologies

Compared with stone and pipe, benefits include:

- Always clean and free of fines
- Bundles are quick to install, saving costs on heavy machinery and labor
- Modular construction allows configurations to match trench dimensions for most system shapes and sizes
- Engineered for optimal storage and absorption efficiencies
- Ability to contour along sloped sites and around trees or landscaping
- Lightweight system is perfect for repairs and tight job sites
- Easily hand-carried into position reducing time and labor
- 5' or 10' lengths with simple snap, internal couplers
- Easier cleanup at the job site with the elimination of stone
- Manufactured from recycled materials rather than a mined natural resource
- A wide variety of diameters and configurations to meet any installation professional's needs
- Approved in many jurisdictions with an increased efficiency rating, reducing drainfield size
- Backed by the leader in the onsite wastewater industry

Bundle System Configurations: Available in 7", 8", 9", 10", 12", 13" and 14" diameter bundles.



Single Bundle

0701P-GEO 1201P-GEO
0801P-GEO 1401P-GEO
1201P-GEO 1801P-GEO
1001P-GEO



Triangular Bundle

1003T-GEO 1303T-GEO
1203T-GEO 1403T-GEO



Horizontal Bundles

0705H-GEO 1303H-GEO 1206H-GEO 1402H-GEO
0904H-GEO 1202H-GEO 1303H-GEO 1802H-GEO
1002H-GEO 1203H-GEO



Vertical Bundles

1002V-GEO 1006V-GEO 1203V-GEO 1206V-GEO
1003V-GEO 1202V-GEO 1204V-GEO 1402V-GEO
1004V-GEO



Notes:

1. Other systems include 10" and 12" bed systems. Bed size will dictate the number of bundles.
2. System dimensions are dependent upon bundle diameter and configuration.
3. LLP is for "Low Pressure Pipe" in which a pressurized distribution pipe is field installed within the corrugated pipe.
4. Internal pipe and couplings meet the requirements of ASTM F405.
5. Bundles are also available without geotextile between the netting and synthetic aggregate.

INFILTRATOR WATER TECHNOLOGIES STANDARD LIMITED WARRANTY

(a) The structural integrity of each EZflow by Infiltrator expanded polystyrene drainfield system and other accessories manufactured by EZflow by Infiltrator ("Units"), when installed and operated in a leachfield of an onsite septic system in accordance with Infiltrator's instructions, is warranted to the original purchaser ("Holder") against defective materials and workmanship for one year from the date that the septic permit is issued for the septic system containing the Units; provided, however, that if a septic permit is not required by applicable law, the warranty period will begin upon the date that installation of the septic system commences. To exercise its warranty rights, Holder must notify Infiltrator in writing at its Corporate Headquarters in Old Saybrook, Connecticut within fifteen (15) days of the alleged defect. Infiltrator will supply replacement Units for Units determined by EZflow by Infiltrator to be covered by this Limited Warranty. EZflow by Infiltrator's liability specifically excludes the cost of removal and/or installation of the Units.

(b) THE LIMITED WARRANTY AND REMEDIES IN SUBPARAGRAPH (a) ARE EXCLUSIVE. THERE ARE NO OTHER WARRANTIES WITH RESPECT TO THE UNITS, INCLUDING NO IMPLIED WARRANTIES OF MERCHANTABILITY OR FITNESS FOR A PARTICULAR PURPOSE

(c) This Limited Warranty shall be void if any part of the EZflow system is manufactured by anyone other than EZflow by Infiltrator. The Limited Warranty does not extend to incidental, consequential, special or indirect damages. Infiltrator shall not be liable for penalties or liquidated damages, including loss of production and profits, labor and materials, overhead costs, or other losses or expenses incurred by the Holder or any third party. Specifically excluded from Limited Warranty coverage are damage to the Units due to ordinary wear and tear, alteration, accident, misuse, abuse or neglect of the Units; the Units being subjected to vehicle traffic or other conditions which are not permitted by the installation instructions; failure to maintain the minimum ground covers set forth in the installation instructions; the placement of improper materials into the system containing the Units; failure of the Units or the septic system due to improper siting or improper sizing, excessive water usage, improper grease disposal, or improper operation; or any other event not caused by Infiltrator. This Limited Warranty shall be void if the Holder fails to comply with all of the terms set forth in this Limited Warranty. Further, in no event shall Infiltrator be responsible for any loss or damage to the Holder, the Units, or any third party resulting from installation or shipment, or from any product liability claims of Holder or any third party. For this Limited Warranty to apply, the Units must be installed in accordance with all site conditions required by state and local codes; all other applicable laws; and Infiltrator's Installation instructions.

(d) No representative of Infiltrator has the authority to change or extend this Limited Warranty. No warranty applies to any party other than the original Holder.

The above represents the Standard Limited Warranty offered by Infiltrator. A limited number of states and counties have different warranty requirements. Any purchaser of Units should contact Infiltrator's Corporate Headquarters in Old Saybrook, Connecticut, prior to such purchase, to obtain a copy of the applicable warranty, and should carefully read that warranty prior to the purchase of Units.



INFILTRATOR®
water technologies

4 Business Park Road
P.O. Box 768
Old Saybrook, CT 06475
860-577-7000 • Fax 860-577-7001
1-800-221-4436
www.infiltratorwater.com

U.S. Patents: 4,759,881; 5,017,041; 5,156,488; 5,336,017; 5,401,116; 5,401,459; 5,511,903; 5,716,163; 5,588,778; 5,839,844 Canadian Patents: 1,329,959; 2,004,564 Other patents pending. Infiltrator, Equalizer, Quick4, and SideWinder are registered trademarks of Infiltrator Water Technologies. Infiltrator is a registered trademark in France. Infiltrator Water Technologies is a registered trademark in Mexico. Contour, MicroLeaching, PolyTuff, ChamberSpacer, MultiPart, PosiLock, QuickCut, QuickPlay, SnapLock and StraightLock are trademarks of Infiltrator Water Technologies. PolyLock is a trademark of PolyLock, Inc. TUF-TITE is a registered trademark of TUF-TITE, INC. Ultra-Rib is a trademark of IPEX Inc.

© 2015 Infiltrator Water Technologies, LLC. All rights reserved. Printed in U.S.A.

EZ01 0315AG

Contact Infiltrator Water Technologies' Technical Services Department for assistance at 1-800-221-4436

**NORTH CAROLINA DEPARTMENT OF HEALTH AND HUMAN SERVICES
DIVISION OF PUBLIC HEALTH
ENVIRONMENTAL HEALTH SECTION
ON-SITE WASTEWATER BRANCH**

INNOVATIVE WASTEWATER SYSTEM APPROVAL
--

INNOVATIVE WASTEWATER NO: IWWS-1995-3-R7

Issued To: EZflow, LP, a wholly owned subsidiary of Infiltrator Water Technologies, LLC
P.O. Box 768
Old Saybrook, CT 06475
(800) 221-4436; Fax; (860) 577-7001
www.ezflowlp.com

Contact: Dave Lentz, PE

For: EZflow Drainfield Systems (formerly Houck Drainage Systems):
EZ1003T (Formerly HDS 2003 Triangular)
EZ1003T-GEO
EZ1203T (Formerly HDS 2012 Triangular)
EZ1203T-GEO
EZ1203H (Formerly HDS 2012 Horizontal)
EZ1203H-GEO

Approval Date:	October 10, 1995	
	October 7, 1998	
	April 18, 2002	
	July 18, 2008	
	March 1, 2011	Addition of 3 foot and 7 foot bundles
	November 30, 2012	Elimination of Warranty Equivalency Factors and Reductions Exceeding 25%
	August 7, 2015	Elimination of particle density specification, update trench levelness requirements, and change company name to Infiltrator Water Technologies, LLC*

*Prior approvals were issued to Infiltrator Systems, Inc. or predecessor companies

In accordance with General Statute 130A-343 and 15A NCAC 18A .1969, an application by EZflow, LP, of Old Saybrook, CT (previously Ring Industrial Group) for a revised approval of the gravelless nitrification trench system has been reviewed, and found to meet the requirements of any innovative system when all of the following conditions are met:

I. General

A. Scope of this Innovative Approval

1. Use, design, and installation requirements for the EZflow Drainfield System.

B. The following EZflow Drainfield System trench models have been found to meet the standards of an innovative system:

- EZ1003T with 6 inch cover
- EZ1003T-GEO with 6 inch cover
- EZ1203T with 6 inch cover
- EZ1203T-GEO with 6 inch cover
- EZ1203H with 6 inch cover
- EZ1203H-GEO with 6 inch cover

II. System Description

A. Minimum pretreatment by septic tank as required in 15A NCAC 18A .1952.

B. EZflow expanded polystyrene aggregate particles (EPS) shall meet the following requirements:

1. EPS shall consist of three dimensional rectangular shapes resembling capital E's placed back-to-back (also known as the "double E") with void channels and surface area protuberances.
2. EPS shall range in size from 0.75 inches to 1.75 inches along any axis.

C. The EZflow Drainfield System units (also referred to as cylindrical units) shall meet the following general specifications:

1. EPS shall be contained in cylindrical high strength netting.
2. The physical and chemical properties of the netting shall be durable and resistive enough to retain the shape of the units and to withstand system installation, backfilling, corrosion, and loss of aggregate under intended use.
3. Cylindrical units shall be manufactured in 3-, 5-, 7-, and 10-foot long sections, +/- 2 inches.
4. The taper, or reduction in diameter, at each end of the cylindrical units shall not begin more than 3 inches from the point of enclosure, as measured along the linear axis of the unit.
5. Cylindrical units shall be able to withstand an AASHTO H-10 axle load of 16,000 pounds when covered with 12 inches of compacted soil and a shallow cover axle load of 4,000 pounds when covered with 6 inches of compacted soil without collapsing, fracturing or breaking when installed in a trench equaling the product configuration width.

D. Allowable configurations are described below:

1. EZ1003T (formerly HDS 2003 Triangular) shall meet the following description and specifications:
 - a. The product shall be comprised of three 10-inch-diameter units 3-, 5-, 7-, or 10-foot long placed in a trench 24 inches wide.
 - b. Two bottom cylinders containing aggregate only, with the netting tied off at both ends to prevent the escape of aggregate, are placed against opposite sides of the trench bottom (retaining a gap of approximately four inches between the bundles when placed in the 24-inch wide trench).
 - c. A third cylinder containing aggregate and a 4-inch diameter flexible plastic perforated pipe as is typically used in nitrification lines is centered on top of the bottom two bundles in the middle of the trench.
 - d. The pipe shall be certified as complying with ASTM F 405, Standard Specifications for Corrugated Polyethylene (PE) Tubing and Fittings, and shall be in accordance with 15A NCAC 18A .1955(f).
 - e. The 4-inch corrugated pipe is surrounded by approximately 2.5 to 3 inches of the EZflow aggregate.

- f. The netting for the central cylinder is tied off at both ends to the pipe. The pipe may be connected by an internal coupling device to allow continuous flow from one section to the next.
 - g. The pipe shall be connected by an internal coupling device to allow continuous connection from one section to the next.
 - h. The end-to-end gap distance between pipe containing cylinders, as measured from the straps fixing the netting to the pipe or from the face edges of aggregate on adjoining cylinders, shall be no greater than 3 inches.
2. EZ1003T-GEO Drainfield System consists of the same product specifications as the EZ1003T as described above with the addition of geotextile fabric prefabricated between the netting and aggregate spanning 180 degrees +/- 15 degrees along the top of each cylinder. The geotextile shall meet the minimum average value specifications described in Table I.
3. EZ1203T shall meet the following description and specifications:
 - a. The product shall be comprised of three 12-inch-diameter units 3-, 5-, 7-, or 10-feet long placed in a trench 30 inches wide.
 - b. Two bottom cylinders containing aggregate only, with the netting tied off at both ends to prevent the escape of aggregate, are placed against opposite sides of the trench bottom creating a gap of approximately 5 to 6 inches between the bundles.
 - c. A third cylinder containing aggregate and a 4-inch diameter perforated flexible plastic pipe as is typically used in nitrification lines is centered on top of the bottom two bundles in the middle of the trench.
 - d. The pipe shall be certified as complying with ASTM F 405, Standard Specifications for Corrugated Polyethylene (PE) Tubing and Fittings, and shall be in accordance with 15A NCAC 18A .1955(f).
 - e. The 4-inch pipe is centered or slightly offset from center towards the top of the cylinder whereby 4 to 6 inches of aggregate is located between the bottom of the pipe and the bottom of the cylinder, and 4 to 1-1/2 inches of aggregate is located between the top of the pipe and the top of the cylinder, respectively.
 - f. The netting for the central cylinder is tied off at both ends to the pipe. The pipe may be connected by an internal coupling device to allow continuous flow from one section to the next.
 - g. The end-to-end gap distance between pipe containing cylinders, as measured from the straps fixing the netting to the pipe or from the face edges of aggregate on adjoining cylinders, shall be no greater than 3 inches.
4. EZ1203T-GEO Drainfield System consists of the same product specifications as the EZ1203T as described above with the addition of geotextile fabric prefabricated between the netting and aggregate spanning 180 degrees +/- 15 degrees along the top of each cylinder. The geotextile shall meet the minimum average value specifications described in Table I.
5. EZ1203H (formally HDS 2012 Horizontal) shall meet the following description and specifications:
 - a. The product shall be comprised of three 12-inch-diameter units 3-, 5-, 7-, or 10-feet long placed side-by-side across the bottom of a 36-inch-wide trench.
 - b. The outer units shall contain aggregate only, with the netting tied off at both ends to prevent the escape of aggregate.
 - c. The central unit shall contain aggregate and a 4-inch-diameter perforated flexible plastic pipe as is typically used in nitrification lines.
 - d. The pipe shall be certified as complying with ASTM F 405, Standard Specifications for Corrugated Polyethylene (PE) Tubing and Fittings, and shall be in accordance with 15A NCAC 18A .1955(f).
 - e. The netting for the central unit shall be tied off at both ends of the pipe.

- f. The 4-inch pipe shall be offset from center towards the top of the unit whereby 5 to 6 inches of aggregate is located between the bottom of the pipe and the bottom of the unit, and 1 ¼- to 2 ½- inches of aggregate is located between the top of the pipe and the top of the unit.
 - g. The pipe shall be connected by an internal coupling device to allow continuous connection from one section to the next.
 - h. The end-to-end gap distance between pipe containing cylinders, as measured from the straps fixing the netting to the pipe or from the face edges of aggregate on adjoining cylinders, shall be no greater than 3 inches.
6. EZ1203H-GEO Drainfield System consists of the same product specifications as the EZ1203H as described above with the addition of geotextile fabric prefabricated between the netting and aggregate spanning 180 degrees +/- 15 degrees along the top of each cylinder. The geotextile shall meet the minimum average value specifications described in Table I.

Table I – Minimum Geotextile Filter Wrap Specifications for EZ1203H-GEO

Property	Value
Unit Weight	0.5 ounces per square yard
Tensile Strength	Cross Direction: 40 N/2.54cm +/- 20% Machine Direction: 50 N/2.54cm +/- 20%
Air Permeability	775 cubic feet per minute +/- 20%

III. Siting Criteria

EZflow Drainfield Systems may be utilized on any site that one can use rock aggregate and pipe which meet the following criteria:

- A. Sites which are classified as Suitable or Provisionally Suitable for a conventional nitrification field system in accordance with 15A NCAC 18A .1948(a) or (b).
- B. Sites which have been reclassified as Provisionally Suitable in accordance with 15A NCAC 18A .1956(2), (4), (5), (6), and (7).
- C. Sites which may be reclassified as Provisionally Suitable in accordance with 15A NCAC 18A .1956(1), except that for the triangular configurations at least 29 inches for EZ1003T and EZ1003T-GEO and at least 31 inches for EZ1203T and EZ1203T-GEO of naturally occurring soil must be present above saprolite, rock, or soil wetness conditions, and all other factors are Suitable or Provisionally Suitable.
- D. Sites which meet the criteria for new or existing fill in accordance with 15A NCAC 18A .1957(b). The provisions of Rule .1957(b) are applicable whenever any portion of the aggregate bundles in an EZflow Drainfield System extends into fill material. There shall be no reduction in trench length compared to conventional gravel trench as computed per Rule .1955 (sizing for all models shall be based on minimum excavated trench width in Table III, Section IVc of this Approval, without the application of an Equivalency Factor). This reference to "fill material" applies to the site fill and not the backfill placed between the trench and the cylinder sidewall.
- E. The required vertical separation shall be measured from the trench bottom.
- F. Where required by soil or site conditions and approved by the local health department, EZflow Drainfield Systems may be installed in lieu of conventional gravel trenches at depths deeper than

36 inches up to a maximum of 60-inches, as measured from the base of the trench. There shall be **no reduction in trench length** compared to a conventional gravel trench as computed per Rule .1955 for EZflow Drainfield Systems installed greater than three feet deep (sizing for all models shall be based on minimum excavated trench width in Table III, Section IVc of this Approval, without the application of an Equivalency Factor). Deep installation details shall be in accordance with EZflow Drainfield Systems North Carolina Design and Installation Manual, including special provisions to assure compliance with federal and state safety procedures for underground excavations.

IV. System Sizing

A. The maximum long-term acceptance rate (LTAR) shall be as follows:

Table II

Textural Group		LTAR (gpd/sq ft)	
		Natural Soil	Saprolite
Soil/Group I (Sands)	Sands	0.8-1.0*	0.6-0.8
	Loamy Sand		0.5-0.7
Soil Group II (Coarse Loams)	Sandy Loam	0.6-0.8	0.4-0.6
	Loam		0.2-0.4
Soil Group III (Fine Loams)	Silt Loam	0.3-0.6	0.1-0.3
	Other Fine Loams		NA
Soil Group IV	Clays	0.1-0.4	NA

* For sites where the LTAR exceeds 1.0 gpd/sq ft, use 1.0 gpd/sq ft.

- B. The LTAR shall be based on the most hydraulically limiting naturally occurring soil horizon within three feet of the ground surface or to a depth of one foot below the trench bottom whichever is deeper.
- C. To determine the minimum total trench bottom area (ft²) required, divide the design daily sewage flow by the applicable LTAR shown in Table II above. The minimum linear footage for EZflow Drainfield Systems shall be determined by dividing the total trench bottom area by the following equivalency factors:

Table III

Product Configuration	Excavated Trench Width	Equivalency Factor (SF/LF)
EZ1003T (2003 Triangular), EZ1003T-GEO	24-inch	3.0
EZ1203T (2012 Triangular), EZ1203T-GEO	30-inch	4.0
EZ1203H (2012 Horizontal), EZ 1203H-GEO	36-inch	4.0

Example:

Three bedroom residence with a design daily sewage flow of 360 gallons on a sandy clay loam (Group III) soil

Total computed trench bottom area is:
 $360 \text{ gpd}/0.5 \text{ LTAR} = 720 \text{ ft}^2$

The required linear footage for EZ1203H-GEO is:
 $720 \text{ ft}^2/4.0 \text{ ft} = 180 \text{ linear ft}$
Where 4.0 ft. is the equivalency factor for the EZ1203H-GEO system

- D. The EZ1203H and EZ1203H-GEO Horizontal Drainfield Systems may be used in a bed system with the three cylindrical bundles placed in rows next to each other. The minimum area (without reduction or equivalency factor) for a bed system shall be determined as required in 15A NCAC 18A .1955(d).
- E. The central cylinder of the EZ1203H and 1203H-GEO Horizontal Drainfield Systems which contains the off-set four-inch pipe may be used as an alternative to rock aggregate in a low pressure pipe (LPP) system, sized equivalent to LPP systems as required in 15A NCAC 18A .1957(a). The single 12-inch diameter cylinder shall be installed within a 12 to 18-inch wide trench. The LPP small diameter pressure laterals (one to two inches) shall be placed within the four-inch pipe sleeve and otherwise designed in accordance with Rule .1957(a). All orifices shall be drilled in the LPP laterals to face upward, except for a hole placed in the middle and a hole placed 25 percent from the distal end of each line, which shall face downward to allow for drainage. The minimum backfill requirement of six inches, as described below, shall also apply.
- F. The available space requirements of Rule .1945 shall be met, and this approved innovative system may be designated as the required replacement system.

V. Special Site Evaluation

A special site evaluation may be required based on the proposed ground absorption system. Refer to Rule .1970(p).

VI. Design Criteria

Refer to Siting Criteria (Section III) and Installation (Section VII) for design details.

VII. Installation

- A. The EZflow Drainfield Systems shall be configured in accordance with Section II and installed in nitrification trenches according to the minimum dimensions in Table IV.

Table IV

Product Configuration	Minimum Trench Spacing (feet)	Trench Width (Inches)	*Minimum Trench Depth (inches)	♣Minimum Pipe Depth below Grade	♣Minimum Pipe Ht. Above Trench Bottom (inches)
EZ1003T, EZ1003T-GEO	7.5	24	23	11	10
EZ1203T, EZ1203T-GEO	9.0	30	25	12	11
EZ1203H, 1203H-GEO	9.0	36	18	12	5 to 6

* On sloping lots, minimum required trench depths may be greater.

♣ Measurements for pipe height are to the pipe invert or bottom of pipe.

- B. A backfill barrier shall be placed over the EPS aggregate cylinders to prevent the infiltration of backfill material into the trench void spaces. The backfill barrier shall be 60 pound weight untreated building paper provided by the manufacturer or alternate with equal or better performance characteristics. An alternate backfill barrier shall be approved in writing by the manufacturer on a case-by-case basis. The barrier shall not be placed along the trench sidewalls below the pipe invert elevation. The barrier must be protected from becoming wet enough to tear until backfilling is completed. The EPS aggregate cylinders with the GEO suffix are prefabricated with a geotextile backfill barrier between the netting and aggregate. The GEO cylinders shall be oriented in the trench with the geotextile covering the top of the system. No additional backfill barrier material shall be required for GEO cylinders.
- C. Native soil removed from the trench excavation may be used as backfill and shall be placed along the sidewalls in the EZflow Triangular Drainfield Systems to a minimum compacted (carefully walked in) height level with the center of the top EPS cylinder. Backfill shall be free of trash or debris. The area adjacent to the cylinders shall be free of large (8" or greater) clods that do not break apart during the walk in procedure. Special attention should be given when backfilling the Triangular Systems so as not to disturb the configuration. Vehicular traffic and excavation equipment should not travel over any uncovered drainfield. The latest version of the manufacturer's installation procedures shall be followed.
- D. EZflow Drainfield System trenches shall be installed level in all directions with a plus or minus one-half-inch tolerance from side-to-side and maximum fall in a single trench bottom not exceeding one-fourth inch in 10 feet end-to-end for any continuous contoured segment. Trenches shall follow the contour of the ground surface elevation (uniform depth). Trenches shall be constructed with all continuous adjoining 3, 5, 7 or 10-foot cylindrical bundles placed end-to-end, with the central bundle distribution pipe interconnected, without any dams, stepdowns or other water stops.
- E. The 10-foot cylindrical bundles shall be used to make up the majority of the line length, with the 3, 5, and 7 foot cylindrical bundles being used only at the distal end of the trench. A maximum of three 3, 5, or 7 foot bundles may be used in any one line length. Examples: A 65 foot trench would utilize 6-10 foot bundles and 1-5 foot bundle, not 13-5 foot bundles. A 71 foot trench would utilize 6-10 foot bundles, two 3 foot bundles and one five foot bundle.
- F. EZflow Drainfield Systems installed on sloping sites may use distribution devices or step downs as described in 15A NCAC 18A .1955(j) and (l) when it is necessary to change level nitrification

line segments from upper to lower elevations. The minimum step-down height for the EZflow Triangular configurations may be reduced to be only up to the center of the pipe in the upstream trench.

- G. Manufacturer's installation instructions for the EZflow Drainfield Systems shall be followed, except as required herein or by 15A NCAC 18A .1900 et. seq.
- H. The system shall be installed by a contractor authorized in writing by EZflow, LP, Infiltrator Water Technologies, LLC, or either company's authorized representative for EZflow Brand Drainfield Systems.

VIII. Operation, Maintenance, and Monitoring

The EZflow Drainfield Systems shall have a minimum classification as a Type IIIg system (other non-conventional trench systems) in accordance with Table V(a) of Rule 15A NCAC 18A .1961(b).

IX. Responsibilities and Permitting

Prior to the installation of the approved EZflow Drainfield System at a site, the owner or owner's agent shall fill out an application at the local health department for the proposed use of this system. The local health department shall issue an Improvement Permit or Construction Authorization or amend a previously issued Construction Authorization allowing the use of an EZflow nitrification trench system. Use of the proposed innovative system and any conditions shall be described in the construction authorization or amended construction authorization, as applicable. Such information shall also be described on the operation permit to be issued upon the acceptable completion of the system installation.

X. Repair of Systems

The provisions of 15A NCAC 18A .1961(l) shall apply to the use of EZflow Drainfield Systems for repairs to existing malfunctioning septic tank systems.

Approved by: _____ Date: _____

**NORTH CAROLINA DEPARTMENT OF HEALTH AND HUMAN SERVICES
DIVISION OF PUBLIC HEALTH
ENVIRONMENTAL HEALTH SECTION
ON-SITE WATER PROTECTION BRANCH**

INNOVATIVE WASTEWATER SYSTEM APPROVAL
--

INNOVATIVE WASTEWATER SYSTEM NO: IWWS 2015-03-R2

Issued To: E-Z Treat Company
PO Box 176
Haymarket, VA 20168
703-408-2911; Fax: 703-753-5043

Contact: Carl Perry, President
Michael Stidham, Vice President

For: E-Z Treat Model 600 Pretreatment Systems

Approval Date: April 24, 2015
June 15, 2015 Tank Size and Sampling Revisions
January 6, 2017 Addition of Single Bulb UV Unit

In accordance with General Statute 130A-343, 15A NCAC 18A .1969 and .1970, a proposal by E-Z Treat Company for an approval of subsurface wastewater systems utilizing the E-Z Treat Pretreatment systems has been reviewed, and found to meet the standards of an innovative system when all of the following conditions are met:

I. General

A. Scope of this Innovative Approval

1. Design, installation, use, and operation and maintenance guidelines for E-Z Treat Pretreatment systems to meet TS-I and TS-II effluent standards pursuant to Rule 15A NCAC 18A .1970. Refer to Rule .1970(a) Table VIII – Effluent Quality Standards for Advanced Pretreatment Systems for treatment performance levels.
2. Operation, maintenance and monitoring requirements for E-Z Treat Pretreatment systems and associated subsurface systems to ensure the treatment performance standards are met.

- B. This Innovative System Approval is applicable to domestic strength sewage systems (non-industrial wastewater) utilizing E-Z Treat Pretreatment Systems that have a design flow not exceeding 3,000 gallons per day (gpd).

Use of E-Z Treat Pretreatment systems for facilities with an influent waste strength that exceeds domestic septic tank quality effluent standards pursuant to Rule 15A NCAC 18A .1970(b) may be proposed by E-Z Treat Company and a North Carolina Professional Engineer to the Department for review and approval on a case-by-case basis, prior to permitting by the local health department (LHD). The system design must include the proposed raw wastewater strength (BOD₅, COD, TN, TSS, fats, oils and grease, etc.), the expected organic loading rate (in pounds

of BOD), and hydraulic loading rate on the pretreatment system, and the calculations, references, and any other needed information to support the proposed design.

- C. Any site utilizing these systems shall have wastewater with sufficient alkalinity to facilitate biological treatment processes. The influent shall not have a pH or toxins that significantly inhibit microbial growth.
- D. Use of E-Z Treat Pretreatment systems that have a design flow exceeding 3,000 gallons per day may be permitted after approval by the Department on a case-by-case basis in accordance with the Large Systems State Review/Approval Process (Rule 15A NCAC 18A.1938).

II. System Description

The E-Z Treat Pretreatment system consists of the following components: a Department approved septic tank; a recirculation tank (or chamber); single or multiple E-Z Treat Pretreatment pods; and a final dosing tank (or chamber). Additional treatment may be used to ensure that treatment performance standards shall be met.

The E-Z Treat Pretreatment system can utilize either a two tank configuration or a three tank configuration. The two tank configuration has the following components: the first tank is a septic tank and the second separate tank has a recirculation chamber and final dosing chamber. The three tank configuration consists of three separate tanks: a septic tank, a recirculation tank, and a final dosing tank.

III. Siting Criteria

The E-Z Treat Pretreatment systems and associated drainfields shall be sited and sized in accordance with Rule .1970 for TS-I and TS-II systems. Drip irrigation systems used with E-Z Treat Pretreatment systems shall be sited and sized in accordance with the manufacturer specific drip approval. The E-Z Treat Pretreatment systems and associated drainfields shall meet all applicable horizontal setback requirements and be located to prevent surface/subsurface water inflow/infiltration.

IV. System Sizing

The system sizing criteria shall be based upon the long term acceptance rate specified in the appropriate portion of the rules or the Innovative and Experimental system approval for the type of ground absorption system to be used.

V. Special Site Evaluation

A special site evaluation may be required based on the proposed ground absorption system. Refer to manufacturer specific drip approvals and Rule .1970(p).

VI. Design Criteria

- A. The E-Z Treat Pretreatment system shall be designed in accordance with the following criteria.
 - 1. All tanks, septic, recirculation, and dosing, must be approved by the Department and E-Z Treat Company specifically for use with the E-Z Treat Pretreatment system.
 - 2. The E-Z Treat Pretreatment system can utilize either a two tank configuration or a three tank configuration. The two tank configuration has the following components: the first tank is a

septic tank and the second separate tank has a recirculation chamber and final dosing chamber. The three tank configuration consists of three separate tanks: a septic tank, a recirculation tank, and a final dosing tank.

3. The E-Z Treat Pretreatment system consists of a septic tank, a recirculation tank/chamber, a final dosing tank/chamber, and E-Z Treat media pod(s) as specified in Table 1 below.

Table 1 – Model 600 and Tank Volumes			
Design Daily Flow (gpd)	Minimum Septic Tank Volume (gallons)	Minimum Recirculation/Pump Tank Volume (gallons)**	Number of Media Pods
< 480	1,000	1,250	1 Model 600 pod
4 Bedrooms	1,000	1,800	1 Model 600 pod
5 Bedrooms	1,250	2,000	1 Model 600 pod
6 Bedrooms	1,500	2,200	2 Model 600 pods
601 – 1,500	$V = 1.17Q^* + 500$	$V = 1.17Q + 500$	1 Model 600 pod per 600 gallons
1,501 – 3,000	$V = 0.75Q + 1,125$	$V = 0.75Q + 1,125$	1 Model 600 pod per 600 gallons

*Q – design daily flow

**Recirculation/pump tank minimum size based on total internal tank volume.

4. Septic tanks will have an inlet sanitary tee and a Department approved, appropriately sized effluent filter on the outlet end approved by the E-Z Treat Company for use with the E-Z Treat.
5. The minimum required volume in the recirculation chamber/tank prior to discharge to the dosing tank/chamber shall be the design daily flow.
6. The recirculation tank/chamber will contain the recirculating splitter valve or an external splitter box may be used. The recirculation tank/chamber shall have an inlet sanitary tee. The sanitary tee shall be visible and reachable from the riser opening to serve as the influent sampling point.
7. When the recirculation tank and dosing tank are combined, the baffle wall between chambers shall extend to the top of the tank and shall be constructed so that the liquid levels in either compartment are independent. Liquids will not by-pass between compartments except as designated by the system's treatment flow path.
8. The final dosing tank must meet the minimum size requirements of Rule .1952(c)(1). For drip irrigation systems, the requirements of the manufacturer specific drip approval for dosing tanks shall also be met.
9. A drainback configuration without a pump check valve is required for the force main supplying the media pod.
10. Recirculation pump shall be either Sta-Rite Model number STEP 20 or manufacturer approved equal.
11. The E-Z Treat media pod is constructed of a polymer suitable for use in contact with wastewater. The Model 600 pod is approximately 7 ft 4 inches x 4 ft with a surface area approximately of 30 square feet and is 42 inches in depth. The pod is fitted with a weatherproof cover properly secured. The pod is designed and constructed to create channels down the sidewalls to facilitate air flow. The sidewall channels provide airspace to the bottom of the pod. The bottom of the vessel is designed to provide total drainage of the treated effluent back to the recirculation tank/chamber.

12. As the effluent enters the recirculation tank/chamber, this tank/chamber acts to further separate the septic tank effluent. The effluent entering the recirculation tank/chamber is charged by the recirculation pump to the media pod(s). The effluent is sprayed over the media mattress(es) using a spray manifold of evenly spaced wide-angle spray nozzles. The nozzles are manufactured with a free passage of 0.0625 inches in diameter. The system is set to recirculate effluent through the media pod on an average of 4 to 6 times prior to discharge.
 13. The effluent is sprayed on mattress(es) measuring a total area of 30 square feet. The mattress(es) are fabricated from a non-biodegradable, chemically resistant, loose weave polypropylene material. The openings in the weave allows for effluent and air flow while containing the media. The media inside the mattress(es) are made of a styrene material. The specific gravity of this material meets the following criteria: light enough to prevent compaction which results in a loss of effective surface area, and provides a reduction in channeling across the media (short-circuiting).
 14. Effluent passes through the media and enters a schedule 40 pipe located at the bottom of the pod. The effluent than gravity feeds back to the recirculation tank/chamber and the process is repeated.
 15. The effluent bypass valve or splitter box is piped to intercept filtered wastewater and deliver it to the recirculation tank/chamber or the dosing tank/chamber, based on liquid volumes.
 16. The Control Panel for the E-Z Treat System will consist of: recirculation pump on/off timer, discharge pump alarm, and high/low water alarm. Control panels shall meet the requirements of .1952 and shall be approved in writing by E-Z Treat Company for use in their systems.
 17. Separate control and alarm circuits will be provided. The E-Z Treat systems will utilize a device for the recording of measurements of daily water flows. The device shall provide a means for determining at least the daily, 7-day, and 30-day flow monitoring requirements of Rule .1970. This information will be stored in the data logger for drip irrigation systems (provided by the manufacturer of the drip irrigation control panel). For pressure manifold and LPP systems, the Aquaworx control panel or manufacturer approved equal shall be used. The operator in responsible charge (ORC) of the system authorized in writing by E-Z Treat Company must be able to access the panel directly on site and shall be available to the LHD with 24-hour notice in the event a direct connection is necessary.
 18. The UV disinfection system shall be rated for the appropriate discharge rate from the E-Z Treat pod. The UV disinfection system will be one of the following:
 - a. E-Z Set UV-1000S (single bulb);
 - b. E-Z Set UV-1000 (dual alternating bulbs); or
 - c. Other UV systems specifically approved by the Department and E-Z Treat Company.
 19. All access riser hatches shall be secured by approved tamper-resistant hardware approved by the manufacturer or by other means approved by the manufacturer as equal. Riser construction, attachment to tanks and security systems shall be pre-approved by the Department and E-Z Treat Company in accordance with the E-Z Treat specific approvals for the septic tanks and pump tanks, as applicable.
 20. Buoyancy calculations shall be completed by a NC Professional Engineer if any parts of the tanks, pods, or other system components are installed in a seasonal high water table. Additional ballast may be required.
 21. Influent samples shall be taken from the inlet sanitary tee into the recirculation tank. Effluent samples shall be taken from the final pump doing tank or a spigot or sampling port that is placed on the force main from the final dosing tank.
- B. E-Z Treat Pretreatment systems shall be designed by a designer authorized in writing by E-Z Treat Company or a NC Professional Engineer. Systems over 1,000 gallons per day shall be designed by a NC Professional Engineer.

VII. Installation and Testing

- A. A preconstruction conference shall be required to be attended by the designer authorized in writing by E-Z Treat Company, engineer (if applicable), installer authorized in writing by E-Z Treat Company, and LHD prior to beginning construction of the E-Z Treat Pretreatment system.
- B. All E-Z Treat Pretreatment systems shall be installed according to directions provided by E-Z Treat Company. Additionally, all E-Z Treat Pretreatment systems and components used with, but not manufactured by E-Z Treat Company shall be installed in accordance with all applicable regulations and manufacturer instructions.
- C. All individuals/companies installing E-Z Treat Pretreatment systems shall be in possession of all necessary permits and licenses before attempting any portion of a new or repair installation. The company/individual must be a Level IV installer and authorized in writing by E-Z Treat Company.
- D. Watertightness of the tanks shall be tested by either of the following protocols: 24-hour hydrostatic test or a vacuum test.
 1. Hydrostatic Test^{1, 2}
 - a. Temporarily seal the inlet and outlet pipes.
 - b. Fill tank with clean water to a point at least two inches above the pipe connections or the seam between the tank and the riser, whichever is highest.
 - c. Measure the water level.
 - d. Allow the tank to sit for 24 hours.
 - e. Re-measure the water level.
 - f. If the water level change is ½-inch or less or one percent of the liquid tank capacity, the tank passes the leak test.
 - g. If the water level change is greater than ½-inch, any visible leaks can be repaired and the tank may be topped off with water and allowed to sit for a minimum of one hour.
 - h. The tank passes the leak test if there are no visible leaks (flowing water or dripping in a steady stream) and no measureable drop in water level after one hour. Otherwise, the tank fails the leak test.
 2. Vacuum Test³
 - a. Temporarily seal the inlet and outlet pipes.
 - b. A vacuum of four (4) inches of mercury should be pulled on the tank and held for five (5) minutes.
 - c. During the testing, the tank manufacturer or their representative can seal the tank if it is found to be leaking.
 - d. If the tank is repaired, the vacuum must be brought back up to four inches and held for five minutes.
- E. The distribution of flow to the E-Z Treat Pretreatment system and to the septic tank shall be measured during start-up and set to be in accordance with the system design with start-up settings recorded.

¹ Victor D'Amato and Ishwar Devkota, *Development of Prefabricated Septic and Pump Tank Construction and Installation Standards for North Carolina*.

² National Precast Concrete Association, *Best Practices Manual Precast Concrete On-Site Wastewater Tanks*, Second Edition, October 2005, 24.

³ National Precast Concrete Association, *Best Practices Manual Precast Concrete On-Site Wastewater Tanks*, Second Edition, October 2005, 24.

- F. Specified site preparation steps and construction specifications for the ground absorption system shall be strictly adhered to, including specified depth of trenches in relation to site limiting conditions, cover material specifications (if needed), trench installation method, etc.
- G. The installer authorized in writing by E-Z Treat Company, the engineer or designer authorized in writing by E-Z Treat Company, and the ORC authorized in writing by E-Z Treat Company shall conduct an inspection/start-up of the E-Z Treat Pretreatment system and all associated system components. The LHD personnel will attend and observe the inspection/start-up. During the inspection/start-up to include:
 - 1. System watertightness testing.
 - 2. Control panel operation and alarm settings.
 - 3. Pump model numbers and time clock settings.
 - 4. Pressure head on the E-Z Treat pod wastewater distribution system.
 - 5. Return flow to the septic tank set per design and recorded, when applicable.
 - 6. Riser hatches have tamperproof bolts, and/or riser lock ring.

VIII. Operation, Maintenance, Monitoring, and Reporting

- A. E-Z Treat Pretreatment systems shall be classified, at a minimum, as a Type Va system in accordance with Table V(a) of Rule .1961(b). Management and inspection shall be in accordance with Rules .1961 and .1970.
- B. All E-Z Treat Pretreatment systems require an operation and maintenance agreement between the system owner and E-Z Treat Company, Inc., its authorized representative, or with an operator authorized in writing by E-Z Treat Company as per Rule .1970. The system shall be inspected according to Rule .1961 by a certified subsurface operator authorized in writing by E-Z Treat Company according. The ORC shall be either an employee of E-Z Treat Company or authorized in writing by E-Z Treat Company to operate and maintain the system. The operator authorized in writing by E-Z Treat Company must have proper equipment and training to access and program the control panels on site.
- C. All E-Z Treat Pretreatment systems shall be operated and maintained according to the latest version of E-Z Treat Company's O&M manual.
- D. At each E-Z Treat Pretreatment system inspection the ORC authorized in writing by E-Z Treat Company shall, at a minimum, observe, monitor, and record the following:
 - 1. Wastewater level in all the tanks.
 - 2. Sludge, scum, and grease levels in all the tanks.
 - 3. Clogging of effluent filter.
 - 4. Watertightness of tanks, risers, and pipe penetrations at the tanks.
 - 5. Operation of pumps, floats, valves, electrical controls, and alarms.
 - 6. Drainfield pump delivery rate (drawdown test), determination of the average pump run time, and drainfield dosing volume.
 - 7. Any structural damage, accessibility issues, adequate ventilation, excess odors, ponding of effluent, insect infestations, vegetative growth over the drainfield, or surfacing of effluent on the drainfield area.
 - 8. Sample of E-Z Treat Pretreatment system effluent collected from the sampling point to check for effluent clarity and odor and a sample of influent, as required.

9. Readings from pump cycle counters and run time meters and any water meter readings, as applicable.
 10. Current operational set up for TS-II nitrogen removal enhancement (percent returned to septic tank), and recommendation for modifications (if needed).
 11. System operating conditions, from the review stored data for indication of 7-day and 30-day flows and flow variances or other abnormal conditions.
- E. The ORC authorized in writing by E-Z Treat Company shall also conduct other additional observations, measurements, monitoring, and maintenances activities as specified in the Operation Permit and as recommended by the manufacturer.
- F. Sampling and Testing
1. All sampling shall be done in accordance with Rule .1970(n)(3) and (5). E-Z Treat systems shall be sampled annually (semi-annually for systems with a design flow of 1,501 to 3,000 gpd).
 2. TS-II systems influent shall be analyzed for TKN.
 3. Effluent for all systems shall be tested for effluent CBOD₅ and NH₄-N. Systems specified to meet the TS-II standard shall also have the effluent analyzed for TN (TKN and NO₃-N). Systems designed to meet the TS-II standard with design flows of 1,501 gpd to 3,000 gpd shall have the effluent analyzed for fecal coliforms.
 4. Additional sampling of effluent or influent may be determined to be necessary by the ORC authorized in writing by E-Z Treat Company during a system inspection to assist with troubleshooting or to verify system performance.
 5. Effluent samples shall be taken from the final dosing tank/chamber or a sampling port located downstream from the final treatment process.
 6. Influent samples shall be taken from a sampling port located between the septic tank and recirculation tank/chamber.
 7. Adjustments in the monitoring schedule and number of parameters sampled may be proposed by E-Z Treat Company and approved by the Department pursuant to Rule .1970(n)(3)(B) or (C).
- G. Notification and Performance of Maintenance and Repairs
1. The ORC authorized in writing by E-Z Treat Company shall alert E-Z Treat Company, the LHD, and the system owner within 48 hours of needed maintenance or repair activities including but not limited to landscaping, tank sealing, tank pumping, pipe or control system repairs, media replacement, and/or adjustments to any other system component.
 2. System troubleshooting and needed maintenance shall be provided to maintain the pump delivery rate and average pump run time within 25% of initial measurements conducted during system startup. The ORC authorized in writing by E-Z Treat Company shall notify the system owner, E-Z Treat Company, and the LHD whenever the pump delivery rate efficiency or average pump ran times are not within 25% of initial measurements conducted prior to system start-up.
 3. The septic tank will be pumped as needed upon recommendation of the ORC authorized in writing by E-Z Treat Company and in accordance with the E-Z Treat Pretreatment system operation and maintenance instructions. However, at a minimum, the septic tank will be pumped whenever the solids level exceeds 25% of the tank's total liquid working capacity or the scum layer is more than four inches thick.
 4. The tanks shall be pumped by a properly permitted septage management firm, and the septage handled in accordance with 15A NCAC 13B .0800.
 5. The ORC authorized in writing by E-Z Treat Company shall notify the LHD, E-Z Treat

Company, and the system owner in writing whenever repairs are indicated. All maintenance activities shall be recorded in the ORC reports provided to the system owner, LHD, and E-Z Treat Company.

H. Reporting

1. The ORC authorized in writing by E-Z Treat Company shall provide a completed written report to the system owner, E-Z Treat Company, and the LHD within 30 days of each inspection. At a minimum this report shall specify:
 - a. The date and time of inspection,
 - b. System operating conditions according to Section VII.D, VII.E, and VII.F.
 - c. Results from any laboratory analysis of any influent and effluent samples,
 - d. Maintenance activities performed since the last inspection report,
 - e. An assessment of overall system performance,
 - f. A list of any improvements or maintenance needed,
 - g. A determination of whether the system is malfunctioning, and the specific nature of the malfunction,
 - h. Any changes made in system settings, based on recommendations of the manufacturer, and
 - i. A summary report of data retrieved from the control panel verifying actual daily, 7-day, and 30-day flows, flow variances, and other operating conditions.

IX. Responsibilities and Permitting Procedures

- A. Prior to the installation of an E-Z Treat Pretreatment system at a site, the owner or owner's agent shall file an application at the LHD for the proposed use of this system. After the LHD conducts a soil and site evaluation, the LHD may issue an Improvement Permit or Authorization to Construct or amend a previously issued Authorization to Construct allowing for the use of a E-Z Treat Pretreatment system.
- B. The Improvement Permit and Authorization to Construct shall contain all conditions the site approval is based upon, including the proposed used of the Innovative system. The Operation Permit will include all conditions specified in the Improvement Permit and the Authorization to Construct.
- C. When a special site evaluation is required pursuant to Rule .1970(p)(1) or a drip approval, as applicable, an evaluation and written, sealed report from a Licensed Soil Scientist regarding the site shall be provided to the LHD. The report shall contain the information as specified in Rule .1970(p)(2) and "Requirements for Submittals of Soil Reports and Pretreatment and/or Dispersal System Designs". The LHD may request the assistance of their Regional Soil Scientist in evaluating this report prior to permit issuance.
- D. The E-Z Treat Pretreatment system shall be designed by one of the following: a designer authorized in writing by E-Z Treat Company or a North Carolina Professional Engineer. Systems over 1,000 gallons per day, or as otherwise required for drip irrigation systems, shall be designed by a North Carolina Professional Engineer.
- E. Prior to issuance of an Authorization to Construct for an E-Z Treat Pretreatment system, a design submittal prepared by a designer authorized in writing by E-Z Treat Company or a North Carolina Professional Engineer shall be submitted for review and approval by the LHD. The

design submittal shall include the information required in "Requirements for Submittals of Soil Reports and Pretreatment and/or Dispersal System Designs".

- F. It is recommended that local authorized environmental health practitioners attend a design training session offered by the manufacturer/authorized representative prior to permitting the system. Also, at the request of the LHD, a Regional Engineer will review the design.
- G. The designer authorized in writing by E-Z Treat Company shall certify in writing that the E-Z Treat Pretreatment system was installed in accordance with the approved design prior to Operation Permit issuance.
- H. A North Carolina Professional Engineer shall certify in writing that a system designed by an engineer was installed in accordance with the approved plans and specifications prior to Operation Permit issuance.
- I. For sites required to be evaluated by a Licensed Soil Scientist or Professional Geologist (see Section V and IX.C), the health department may specify as a condition on the Improvement Permit and Authorization to Construct that a Licensed Soil Scientist or Professional Geologist oversee critical phases of the drainfield installation and certify in writing that the installation was in accordance with their specified site/installation requirements prior to the Operation Permit issuance.
- J. The ORC authorized in writing by E-Z Treat Company shall be present during the final inspection of the system prior to the issuance of the operation permit. The ORC shall be certified as a NC Subsurface Operator and authorized in writing by E-Z Treat Company.
- K. The LHD issues the Operation Permit after the following:
 - 1. Field verification of installation completion;
 - 2. Receipt of written documentation from the designer authorized in writing by E-Z Treat Company or the engineer, as applicable, that the system has been designed, installed, and is operating in accordance with the approved plans; and
 - 3. All necessary legal documents have been completed, including the contract between the system owner and the ORC authorized in writing by E-Z Treat Company.
- K. On an annual basis, E-Z Treat Company shall provide a report to the On-Site Water Protection Branch including the number and location of new system installations during the previous year, and effluent data and operator reports for each operational E-Z Treat Pretreatment system installed in North Carolina under this Innovative Approval. Effluent data should be compiled and submitted electronically. If available, a web-based system for data posting of laboratory results should be utilized. These reports shall provide information to the Department based upon the monitoring data and observations made from the Innovative systems installed pursuant to this Approval. This should include an assessment of system performance in relation to the established treatment performance standards; an assessment of physical and chemical properties of the materials used to construct the system, in terms of strength, durability, and chemical resistance to loads and conditions experienced, recommended areas of applicability for the system; and any conditions and limitations related to the use of the system. The report shall also include an updated list of authorized designers, installers, and ORCs.

X. Repair of Systems

IWWS-2015-03-R2
January 6, 2017
Page 10 of 10

The provisions of 15A NCAC 18A .1961(l) shall govern the use of the E-Z Treat Pretreatment System for repairs to existing malfunctioning wastewater systems.

Approved By: _____ Date: _____

NSF International

789 N. Dixboro Road, Ann Arbor, MI 48105 USA

RECOGNIZES

E-Z Treat

Haymarket, VA

AS COMPLYING WITH NSF/ANSI 40, 245, 350 AND ALL APPLICABLE REQUIREMENTS.
PRODUCTS APPEARING IN THE NSF OFFICIAL LISTING ARE
AUTHORIZED TO BEAR THE NSF MARK.



Certification Program
Accredited by the
American National
Standards Institute



Certification Program
Accredited by the
Standards Council
of Canada

This certificate is the property of NSF International and must be returned upon request. This certificate remains valid as long as this client has products in Listing for the referenced standards. For the most current and complete Listing information, please access NSF's website (www.nsf.org).

December 18, 2015
Certificate# C0173848 - 02

Lori Bestervelt

Lori Bestervelt
Executive Vice President & CTO



OFFICIAL LISTING

NSF International Certifies that the products appearing on this Listing conform to the requirements of
NSF/ANSI Standard 245 - Wastewater Treatment Systems - Nitrogen Reduction

This is the Official Listing recorded on December 18, 2015.

E-Z Treat
P.O. Box 176
Haymarket, VA 20618
703-753-4770

Facility: Rocky Mount, NC

Model Number	Rated Capacity Gallons/Day
#600	600
#1200	1200

Note: Additions shall not be made to this document without prior evaluation and acceptance by NSF International.
1 of 1



OFFICIAL LISTING

NSF International Certifies that the products appearing on this Listing conform to the requirements of NSF/ANSI Standard 350 - Onsite Residential and Commercial Water Reuse Treatment Systems

This is the Official Listing recorded on December 18, 2015.

E-Z Treat
P.O. Box 176
Haymarket, VA 20618
703-753-4770

Facility: Rocky Mount, NC

Model Number	Rated Capacity Gallons/Day	Classification	Type
#600	600	Class R	Wastewater
#1200	1200	Class R	Wastewater

NOTE: Class R - Single family residential dwellings

Note: Additions shall not be made to this document without prior evaluation and acceptance by NSF International.
1 of 1

DAVID BRANTLEY & SONS
 37 Pine Ridge Rd
 Zebulon, NC 27597
 Office 919-573-0443
 Fax 919-573-0443
 brantley@gmail.com

PREPARED FOR: David Brantley & Sons
 37 Pine Ridge Rd
 Zebulon, NC 27597

DATE: April 11, 2014

CONTACT: DORY BRANTLEY

REVISION NO.	DATE
Original Submitted	April 11, 2014
Revision 1	
Revision 2	
Revision 3	
Revised Set	

BRANTLEY TANK MOOR
3,160 ST
H20-419

SHEET NUMBER

1 of 1

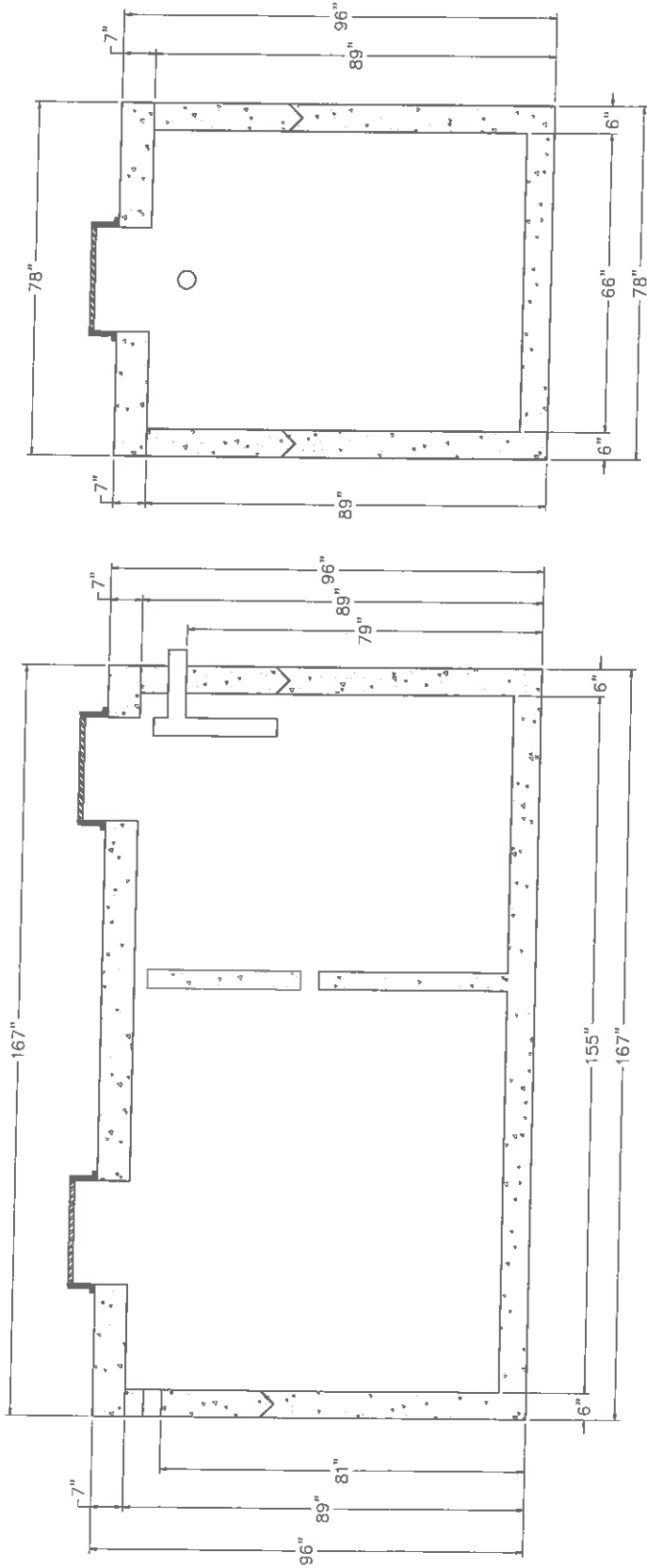

3,160 ST H20-419
 NTS
SEPTIC TANK

DAVID BRANTLEY & SONS
 37 Pine Ridge Rd
 Zebulon, NC 27897
 Office 252-478-3721
 Fax 919-573-0443
 Installer@gmail.com

PREPARED FOR: David Brantley & Sons
 37 Pine Ridge Rd
 Zebulon, NC 27897

DATE: April 11, 2014

CONTACT: CONY BRANTLEY

Revision 5	Revised	DATE
Revision 4	Revised	DATE
Revision 3	Revised	DATE
Revision 2	Revised	DATE
Revision 1	Revised	DATE
Original Submitted	DATE	April 11, 2014
REVISION NO.	DATE	

BRANTLEY TANK MODEL
 2,000 GT

SHEET NUMBER
 1 of 1

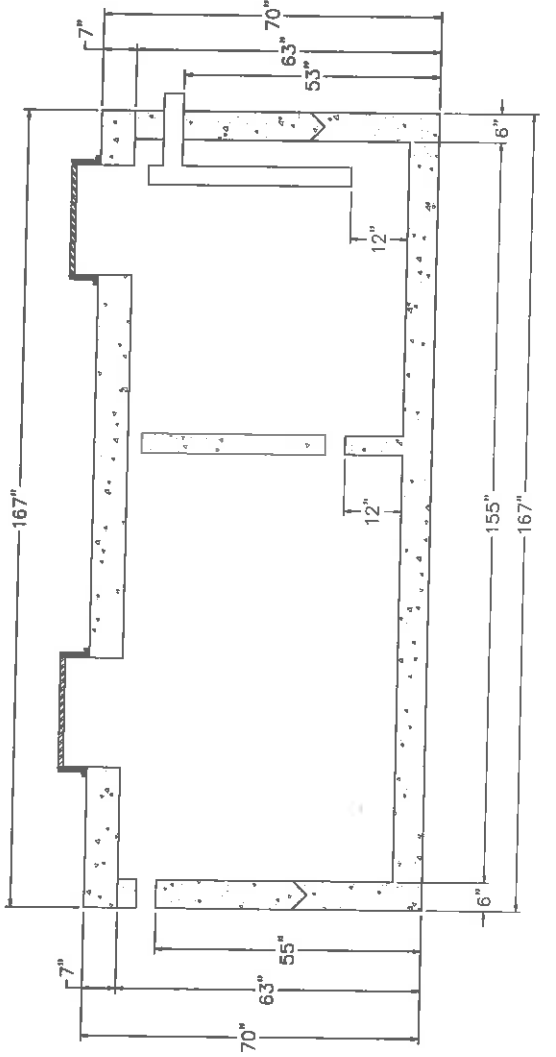
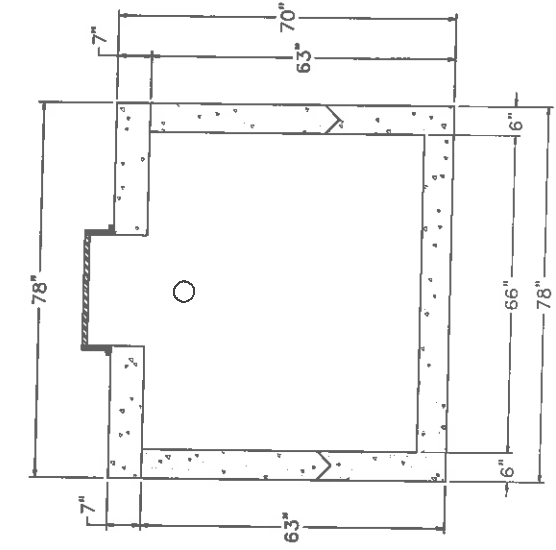

2,000 GT
 NTS
 GREASE TRAP TANK

DAVID BRANTLEY & SONS
 37 Pine Ridge Rd
 Zebulon, NC 27597
 Office 252-478-3721
 Fax 919-573-0443
 Installer@gmail.com

PREPARED FOR: David Brantley & Sons
 37 Pine Ridge Rd
 Zebulon, NC 27597

REVISION NO.	DATE
Original Standard	April 11, 2014
Revision 1	
Revision 2	
Revision 3	
Master Set	

DATE: April 11, 2014
 CONTRACTOR: DAVID BRANTLEY

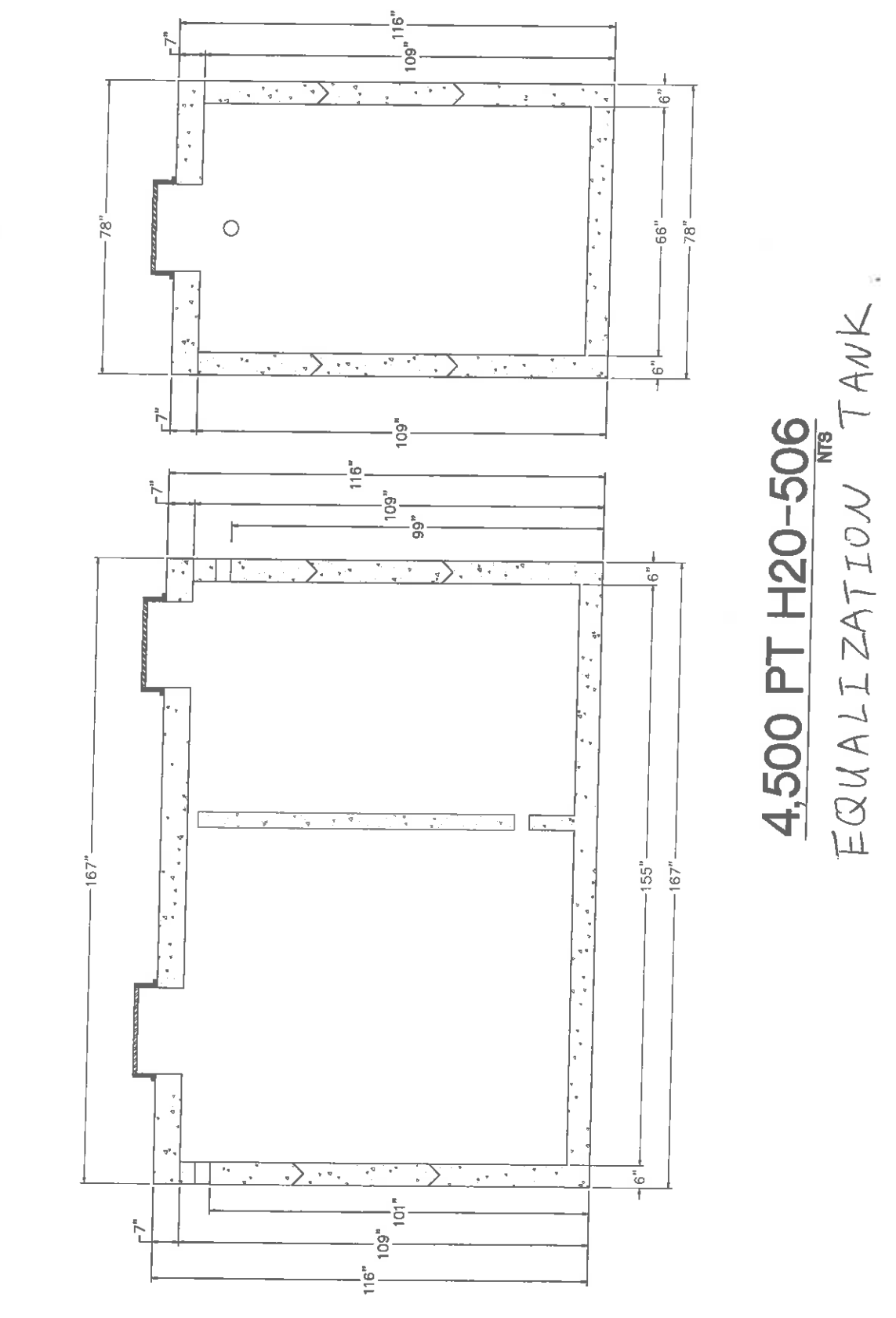

BRANTLEY TANK MODEL
4,500 PT
H20-506
 SHEET NUMBER
1 of 1

* Baffle Wall Optional.

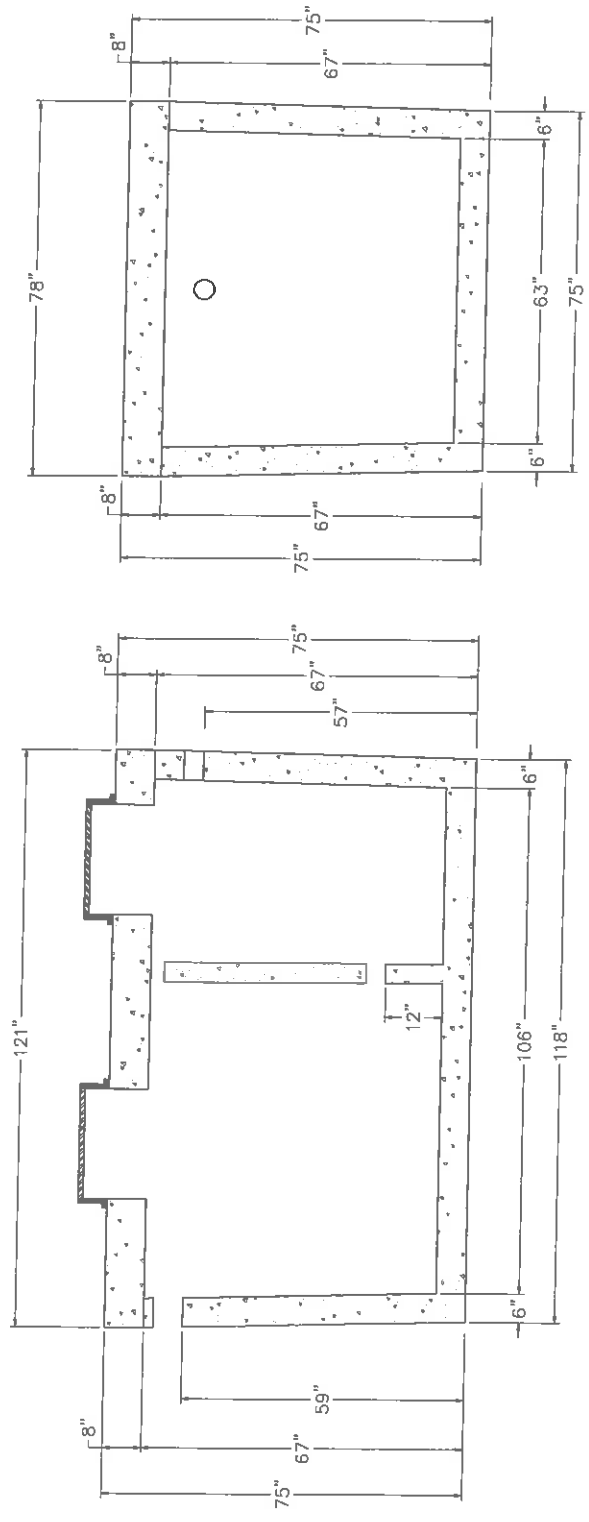

1,850 PT H20-366
 NTS
 RECIRCULATION TANK

PREPARED FOR: David Brantley & Sons 37 Pine Ridge Rd. Zebulon, NC 27597		DATE: April 11, 2014		CONTACT: CORY BRANTLEY		37 Pine Ridge Rd. Zebulon, NC 27597 Office 252-478-3721 Fax 919-573-0443 brantley@gmail.com	
REVISION NO.	DATE	Original Submittal	April 11, 2014	Revision 1		Revision 2	
				Revision 3			
				Master Set			

BRANTLEY TANK MODEL
 1,850 PT
 H20-366
 SHEET NUMBER
 1 of 1

* Baffle Wall Optional

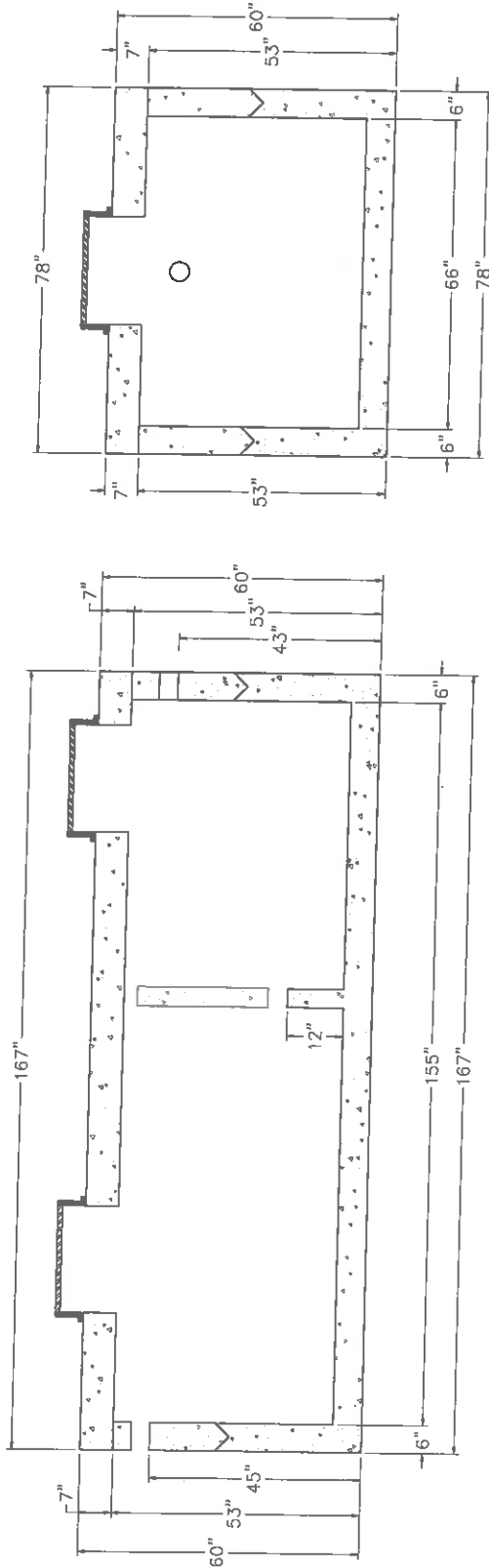

2,000 PT H20-386

NTS

FIELD DOSING TANK

DAVID BRANTLEY & SONS
 37 Pine Ridge Rd
 Zebulon, NC 27597
 Office 252-478-8721
 Fax 919-573-0443
 Installer@gmail.com

PREPARED FOR : David Brantley & Sons 37 Pine Ridge Rd. Zebulon, NC 27597	REVISION NO.	DATE
DATE : April 11, 2014	Original Submitted	April 11, 2014
CONTRACT: CORY BRANTLEY	Revision 3	
	Revision 2	
	Revision 1	
	Water Sht	

BRANTLEY TANK MODEL
2,000 PT
H20-386

SHEET NUMBER

1 of 1



Submittal Specification

A flexible pipe-to-structure connector shall be employed in the connection of the sanitary sewer pipe to precast structures. The connector shall be CAST-A-SEAL® 402/402F as manufactured by Press-Seal Corporation, Fort Wayne, Indiana, or approved equal. The connector shall be the sole element relied on to assure a flexible, watertight seal of the pipe to the precast structure. The connector shall consist of a rubber gasket and an external take-up clamp.

The rubber gasket element shall be constructed solely of synthetic or natural rubber, and shall meet or exceed the physical property requirements of ASTM C 923.

The external take-up clamp shall be constructed of Series 300 non-magnetic stainless steel and shall utilize no welds in its construction. The clamp shall be installed by torquing the adjusting screw using a

torque-setting wrench available from the connector manufacturer.

Selection of the proper size connector for the structure and pipe requirement, and installation thereof, shall be in strict conformance with the recommendations of the connector manufacturer. Any dead end pipe stubs installed in connectors shall be restrained from movement per ASTM C 923.

The finished connection shall provide sealing to 13 psi (minimum) and shall accommodate deflection of the pipe to 7 degrees (minimum) without loss of seal.

Vacuum testing shall be conducted in strict conformance with ASTM C 1244 prior to backfill. Other testing shall be conducted in strict conformance with the requirements of the connector manufacturer.

CAST-A-SEAL 402	PIPE SIZE	PIPE O.D. RANGE	WALL THICKNESS*	APPLICATION
452.0250	1.25" - 2" (31 - 51 mm)	1.5" - 2.75" (38 - 70 mm)	2.5" - 6" (64 - 150 mm)	STANDARD
452.0402F1	4" (100 mm)	4.2" - 4.7" (107 - 119 mm)	2.5" - 4.0" (64 - 102 mm)	Closed Face
CAS ADAPTER	3" (75 mm)	3.2" - 3.6" (81 - 91 mm)	---	Use with 4" CAST-A-SEAL

PRODUCT PERFORMANCE

CAST-A-SEAL 402/402F meets and/or exceeds all requirements of ASTM C 923, including physical properties of materials and performance testing, including:

- 13 psi minimum in straight alignment
- 10 psi at minimum 7° angle
- 10 psi minimum under shear load of 150 lbs/in. pipe diameter

CAST-A-SEAL 402/402F meets and/or exceeds the requirements of the following Standards, Specifications, Codes, and Test Methods:

- ASTM C 923 *Standard Specification for Resilient Connectors Between Reinforced Concrete Manhole Structures, Pipes, and Laterals*
- ASTM C 1644 *Standard Specification for Resilient Connectors Between Reinforced Concrete On-Site Wastewater Tanks and Pipes*
- ASTM C 1478 *Standard Specification for Storm Drain Resilient Connectors Between Reinforced Concrete Storm Sewer Structures, Pipes and Laterals*
- ASTM C 1244 *Standard Test Method for Concrete Sewer Manholes by the Negative Air Pressure (Vacuum) Test*
- IAPMO/ANSI Z1000 *Standard for Prefabricated Septic Tanks*
- IAPMO/ANSI Z1001 *Standard for Prefabricated Gravity Grease Interceptors*
- NPCA *Best Practices Manual for Precast Concrete On-Site Wastewater Tanks*
- NOWRA *Model Code Framework*

TYPICAL TEST RESULTS for CAST-A-SEAL 402/402F (as in ASTM C 1644, C 923, and C 1478)			
Test	ASTM Test Method	Test Requirements	Typical Result
CHEMICAL RESISTANCE; 1N SULFURIC ACID and 1N HYDROCHLORIC ACID	D 534, AT 22°C FOR 48 HRS	NO WEIGHT LOSS NO WEIGHT LOSS	NO WEIGHT LOSS NO WEIGHT LOSS
TENSILE STRENGTH	D 412	1200 PSI, MIN.	2100 PSI
ELONGATION AT BREAK	D 412	350%, MIN.	525%
HARDNESS	D 2240 (SHORE A DUROMETER)	±5 FROM THE MANUFACTURER'S SPECIFIED HARDNESS	<2
ACCELERATED OVEN-AGING	D 573, 70± 1°C FOR 7 DAYS	DECREASE OF 15%, MAX. OF ORIGINAL TENSILE STRENGTH, DECREASE OF 20%, MAX. OF ELONGATION	-13% TENSILE CHANGE, -14% ELONGATION CHANGE
COMPRESSION TEST	D 395, METHOD B, AT 70°C FOR 22 HRS	DECREASE OF 25%, MAX. OF ORIGINAL DEFLECTION	13%
WATER ABSORPTION	D 471 IMMERSE 0.75 BY 2-IN. SPECIMEN IN DISTILLED WATER AT 70°C FOR 48 hrs	INCREASE OF 10%, MAX. OR ORIGINAL BY WEIGHT	3.50%
OZONE RESISTANCE	D 1171	RATING 0	PASS
LOW-TEMP. BRITTLE POINT	D 746	NO FRACTURE AT -40°C	PASS
TEAR RESISTANCE	D 624, METHOD B	200 LBF/IN. (MIN.)	450 LBF/IN.

Press-Seal believes all information is accurate as of its publication date. Information, specifications, and prices are all subject to change without notice. Press-Seal is not responsible for any inadvertent errors. Copyright 2012.



CAST-A-SEAL® 402/402F

CAST-IN BOOT-TYPE CONNECTOR
for 1-1/4" to 6" PVC Pipe
(32 mm - 150 mm)

What It Is

CAST-A-SEAL 402/402F is a watertight flexible connector that is cast into the structure when the concrete is poured. The connector is folded into the casting position and placed on the reusable heavy-duty solid plastic mandrel that is installed directly to the form. After the concrete is cured, the form is opened, removing the mandrel from the gasket, but leaving the **CAST-A-SEAL 402/402F** connector embedded in the concrete. The gasket is then simply unfolded at the jobsite and is tightened around the pipe using the supplied stainless steel take-up clamp.

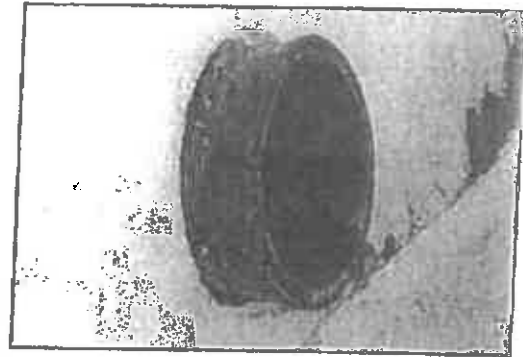

How It Performs

CAST-A-SEAL 402/402F meets or exceeds all requirements of the following Standards, Codes, Specifications and/or Test Methods:

- | | |
|--------------------|----------------------------|
| ASTM C 1227 | IAPMO Z1000 |
| ASTM C 1644 | IAPMO Z1001 |
| ASTM C 923 | NPCA Best Practices |
| ASTM C 1244 | NOWRA Model Code |
| | ASTM C 1478 |

Why It's Better

- Simple cast-in design provides flexible watertight connection.
- Eliminates infiltration and exfiltration.
- Improves on-site system performance and minimizes maintenance.
- Protects groundwater from unintended discharges.
- Use in on-site treatment structures, grease interceptors, manholes, wet wells, pump and lift stations, stormwater structures, or any application requiring a flexible watertight connector.

Scan (or click) Here To View More Info On This Product On The Web!

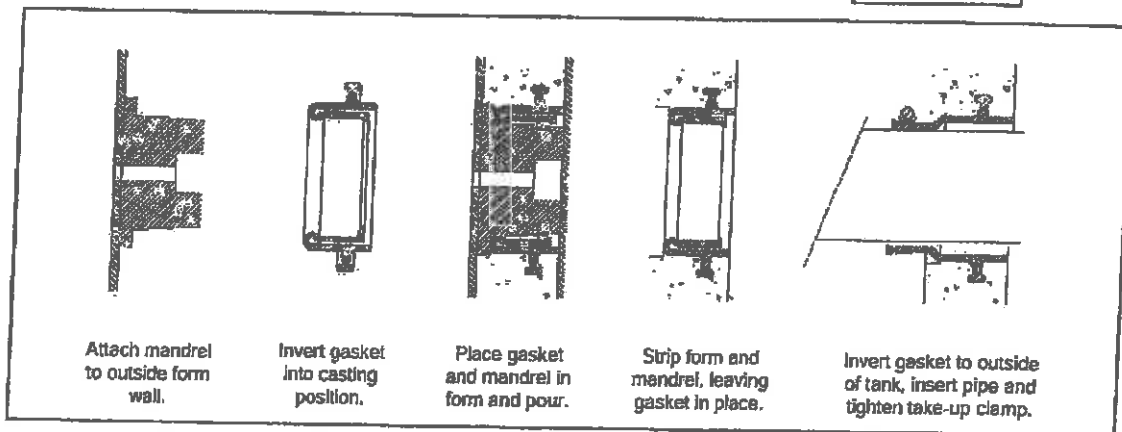

Press-Seal believes all information is accurate as of its publication date. Information, specifications, and prices are all subject to change without notice. Press-Seal is not responsible for any inadvertent errors. Copyright 2012.

Phone: 800-348-7325
Fax: (260) 436-1908

62
PRESS-SEAL CORPORATION
Protecting Our Planet's Clean Water Supply
ISO 9001:2008 Registered • ISO/IEC 17025 Accredited

Email: sales@press-seal.com
Web: www.press-seal.com

VER
B
J
O
N
2-W



EZset by Infiltrator risers and lids are made from glass reinforced polypropylene, providing superior strength and durability. They come in green or black and in 20", 24", and 30" diameters making them ideal for use with any concrete or plastic tank. The slip resistant lids are fastened using stainless steel screws and can be further secured by installing locking rings.

20" Riser System

- 20" x 6" Risers (Green or Black)
- 20" x 12" Risers (Green or Black)
- 20" Lids (Green or Black)



20" x 6" Riser



20" x 12" Riser



20" Lid



Adapter Flange

24" Riser System

- 24" x 6" Risers (Green or Black)
- 24" x 12" Risers (Green or Black)
- 24" x 18" Risers (Green or Black)
- 24" Lids (Green or Black)



24" x 6" Riser



24" x 12" Riser



24" x 18" Riser



24" Lid

30" Riser System

- 30" x 12" Risers (Green or Black)
- 30" Lids (Green or Black)



30" x 12" Riser



30" Lid

- Adhesive Sealant
- 20" Locking Rings
- 20" Safety Pans
- 24" Locking Rings
- 24" Safety Pans
- 24" Adapter Rings
- 30" Locking Rings



EZset
by INFILTRATOR

Riser Specifications

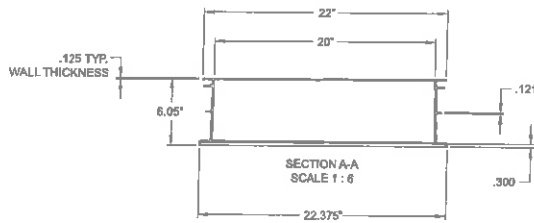

20" x 6" Riser Cutaway

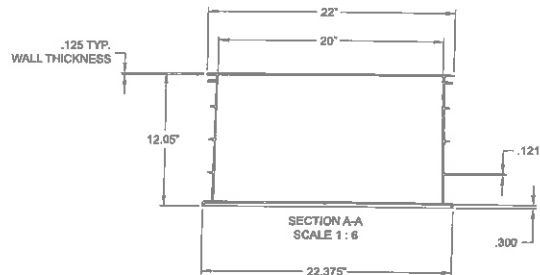

20" x 12" Riser Cutaway

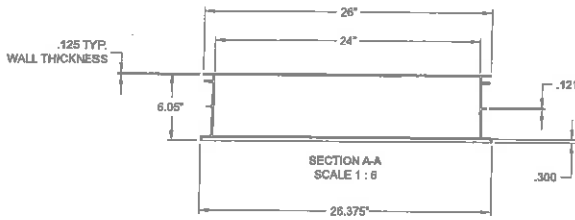

24" x 6" Riser Cutaway

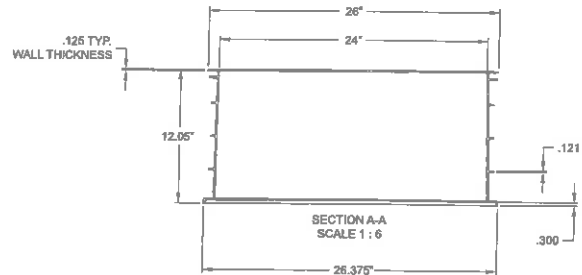

24" x 12" Riser Cutaway

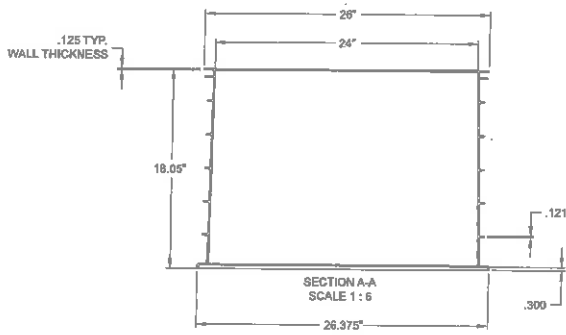

24" x 18" Riser Cutaway

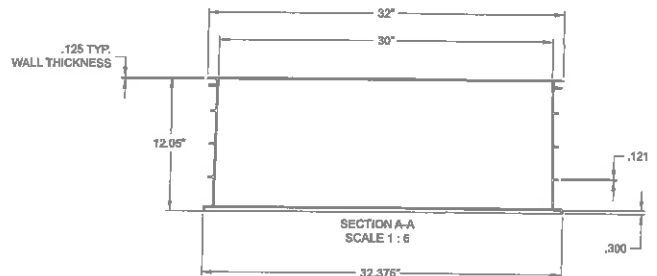

30" x 12" Riser Cutaway

INFILTRATOR WATER TECHNOLOGIES, LLC ("Infiltrator")
EZset by Infiltrator LIMITED WARRANTY
ONE (1) YEAR MATERIALS AND WORKMANSHIP LIMITED WARRANTY

(a) This limited warranty is extended to the end user of an EZset by Infiltrator riser and lid system and other accessories. An EZset system manufactured by Infiltrator, when installed and operated in accordance with Infiltrator's installation instructions and local regulation by a licensed installer, is warranted to you: (i) against defective materials and workmanship for one (1) year after installation. Infiltrator will, at its option, (i) repair the defective product or (ii) replace the defective materials. Infiltrator's liability specifically excludes the cost of removal and/or installation of the EZset system.

(b) In order to exercise its warranty rights, you must notify Infiltrator in writing at its corporate headquarters in Old Saybrook, Connecticut within fifteen (15) days of the alleged defect.

(c) YOUR EXCLUSIVE REMEDY WITH RESPECT TO ANY AND ALL LOSSES OR DAMAGES RESULTING FROM ANY CAUSE WHATSOEVER SHALL BE SPECIFIED IN SUBPARAGRAPH (a) ABOVE. INFILTRATOR SHALL IN NO EVENT BE LIABLE FOR ANY CONSEQUENTIAL OR INCIDENTAL DAMAGES OF ANY KIND, HOWEVER OCCASIONED, WHETHER BY NEGLIGENCE OR OTHERWISE. SOME STATES DO NOT ALLOW THE EXCLUSION OR LIMITATION OF INCIDENTAL OR CONSEQUENTIAL DAMAGES, SO THIS LIMITATION OR EXCLUSION MAY NOT APPLY TO YOU. THIS WARRANTY GIVES YOU SPECIFIC LEGAL RIGHTS AND YOU MAY ALSO HAVE OTHER RIGHTS WHICH VARY FROM STATE TO STATE.

(d) THIS LIMITED WARRANTY IS THE EXCLUSIVE WARRANTY GIVEN BY INFILTRATOR AND SUPERSEDES ANY PRIOR, CONTRARY, ADDITIONAL, OR SUBSEQUENT REPRESENTATIONS, WHETHER ORAL OR WRITTEN. INFILTRATOR DISCLAIMS AND EXCLUDES TO THE GREATEST EXTENT ALLOWED BY LAW ALL OTHER WARRANTIES, WHETHER EXPRESS OR IMPLIED, OR STATUTORY, INCLUDING ANY WARRANTY OF MERCHANTABILITY. FINESSE FOR A PARTICULAR PURPOSE AND ANY IMPLIED WARRANTIES OTHERWISE ARISING FROM COURSE OF DEALING, COURSE OF PERFORMANCE, OR USAGE OF TRADE. NO PERSON (INCLUDING ANY EMPLOYEE, AGENT, DEALER, OR REPRESENTATIVE) IS AUTHORIZED TO MAKE ANY REPRESENTATION OR WARRANTY CONCERNING THIS PRODUCT, EXCEPT TO REFER YOU TO THIS LIMITED WARRANTY. EXCEPT AS EXPRESSLY SET FORTH HEREIN, THIS WARRANTY IS NOT A WARRANTY OF FUTURE PERFORMANCE, BUT ONLY A WARRANTY TO REPAIR OR REPLACE.

(e) YOU MAY ASSIGN THIS LIMITED WARRANTY TO A SUBSEQUENT PURCHASER OF YOUR HOME.

(f) NO REPRESENTATIVE OF INFILTRATOR HAS THE AUTHORITY TO CHANGE THIS LIMITED WARRANTY IN ANY MANNER WHATSOEVER, OR TO EXTEND THIS LIMITED WARRANTY.

CONDITIONS AND EXCLUSIONS

There are certain conditions or applications over which Infiltrator has no control. Defects or problems as a result of such conditions or applications are not the responsibility of Infiltrator and are NOT covered under this warranty. They include failure to install the EZset system in accordance with instructions or applicable regulatory requirements or guidance, altering the EZset system contrary to the installation instructions and disposing of chemicals or other materials contrary to normal EZset system usage.

The above represents the Standard Limited Warranty offered by Infiltrator. A limited number of states and counties have different warranty requirements. Any purchaser of an EZset system should contact Infiltrator's corporate headquarters in Old Saybrook, Connecticut, prior to such purchase to obtain a copy of the applicable warranty, and should carefully read that warranty prior to the purchase of an EZset system.



INFILTRATOR[®]
systems inc.

4 Business Park Road
P.O. Box 768
Old Saybrook, CT 06475
860-577-7000 • Fax 860-577-7001
1-800-221-4436
www.infiltratorwater.com

U.S. Patents: 4,759,661; 5,017,041; 5,166,488; 5,336,017; 5,401,116; 5,401,459; 5,511,903; 5,716,163; 5,588,778; 5,839,844 Canadian Patents: 1,329,959; 2,004,564 Other patents pending. Infiltrator, Equalizer, Quick4, and SideWinder are registered trademarks of Infiltrator Water Technologies. Infiltrator is a registered trademark in France. Infiltrator Water Technologies, is a registered trademark in Mexico. Contour, MicroLeaching, PolyTuff, ChamberSpacer, MultiPort, PosiLock, QuickCut, QuickPlay, SnapLock and StraightLock are trademarks of Infiltrator Water Technologies. PolyLok is a trademark of PolyLok, Inc. TUF-TITE is a registered trademark of TUF-TITE, INC. Ultra-Rib is a trademark of IPEX Inc.

© 2013 Infiltrator Water Technologies, LLC. All rights reserved. Printed in U.S.A.

SET01 06131SI

Contact Infiltrator Water Technologies' Technical Services Department for assistance at 1-800-221-4436

PL-625 Filter

The PL-625 filter is ideal for grease trap applications. The 1/32" filtration has been shown to reduce fats, oils, and grease (FOG) by as much as 60% to 98%! The filter may be used in onsite wastewater systems that require a finer level of TSS removal. Whatever the application, Polylok has the filter for you!

Features:

- Rated for 8,000 GPD (gallons per day).
- 625 linear feet of 1/32" filtration.
- Accepts 4" and 6" SCHD 40 pipe.
- Built in gas deflector.
- Automatic shut-off ball when filter is removed.
- Alarm accessibility.
- Accepts PVC extension handle.

PL-625 Installation:

Ideal for residential and commercial waste flows up to 8,000 gallons per day (GPD).

1. Locate the outlet of the septic tank.
2. Remove the tank cover and pump tank if necessary.
3. Glue the filter housing to the 4" or 6" outlet pipe. If the filter is not centered under the access opening use a Polylok Extend & Lok or piece of pipe to center filter.
4. Insert the PL-625 filter into its housing.
5. Replace and secure the septic tank cover.

PL-625 Maintenance:

The PL-625 Effluent Filters will operate efficiently for several years under normal conditions before requiring cleaning. It is recommended that the filter be cleaned every time the tank is pumped, or at least every three years. If the installed filter contains an optional alarm, the owner will be notified by an alarm when the filter needs servicing. Servicing should be done by a certified septic tank pumper or installer.

1. Locate the outlet of the septic tank.
2. Remove tank cover and pump tank if necessary.
3. Do not use plumbing when filter is removed.
4. Pull PL-625 cartridge out of the housing.
5. Hose off filter over the septic tank. Make sure all solids fall back into septic tank.
6. Insert the filter cartridge back into the housing making sure the filter is properly aligned and completely inserted.
7. Replace and secure septic tank cover.

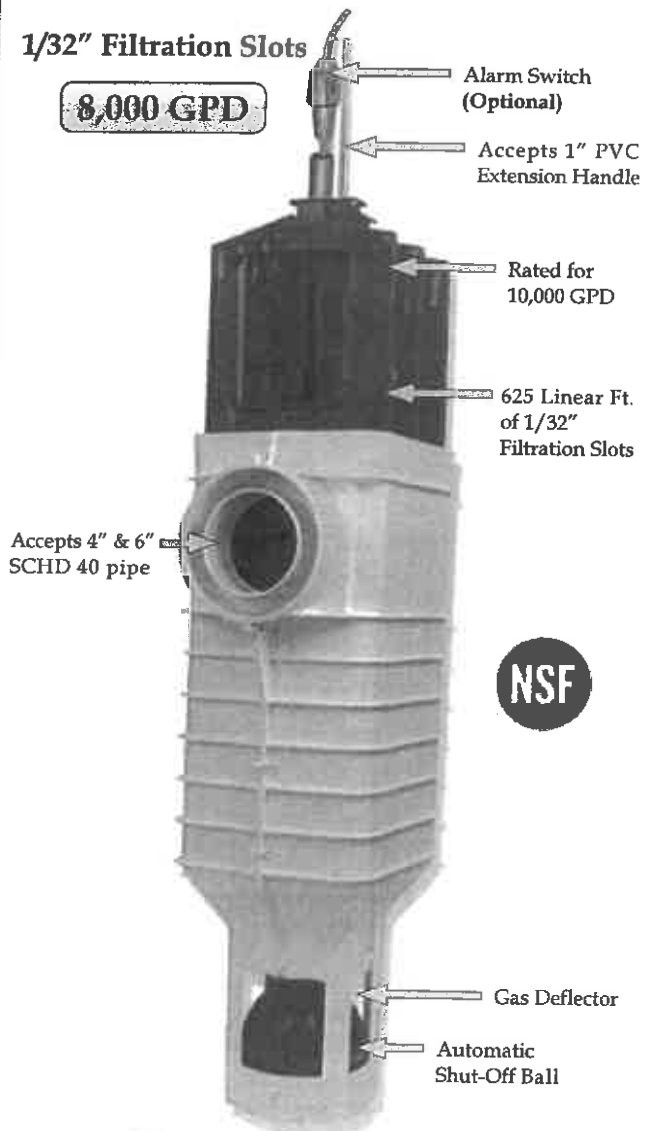

Outdoor SmartFilter® Alarm
 Polylok, Zabel & Best filters accept the SmartFilter® switch and alarm.

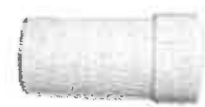

Extend & Lok™
 Easily installs into existing tanks.

INSTALLATION INSTRUCTIONS

PL-122/PL-525/PL-625 FILTER

INSTALLATION INSTRUCTIONS

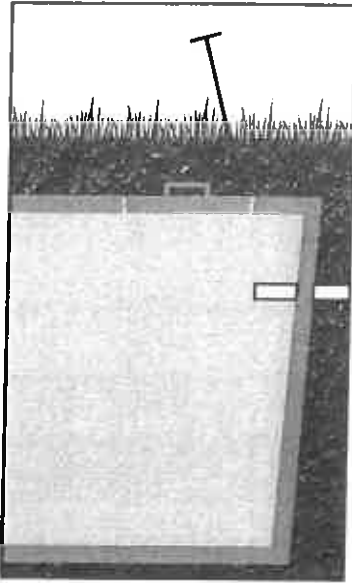

Step 1:

- (A) Locate the outlet of the septic tank.
- (B) Remove tank cover and pump tank if necessary.

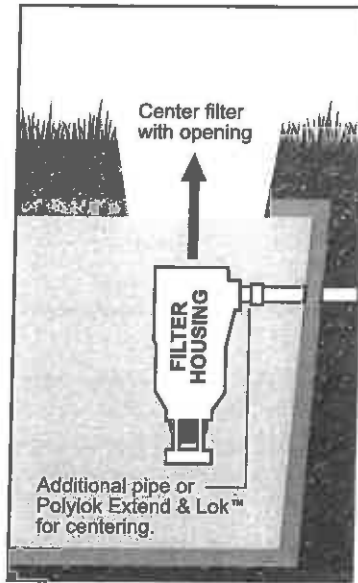

Step 2:

- (A) Before installation, place the filter housing on to the outlet pipe.
- (B) Make sure that the housing is positioned so the filter can be removed from the tank for maintenance and service.

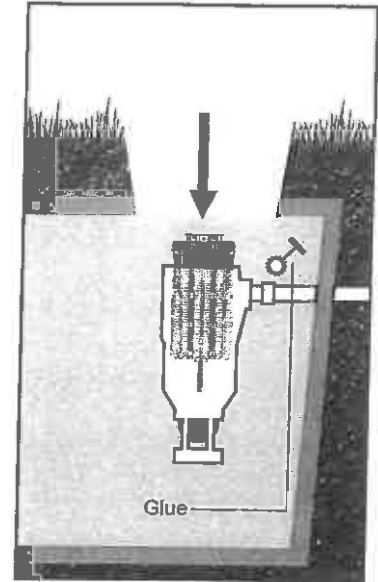

Step 3:

- (A) Glue the filter housing on the outlet pipe.
- (B) Insert the filter cartridge in the housing, making sure the filter cartridge is properly aligned and completely inserted in the housing.

MAINTENANCE INSTRUCTIONS

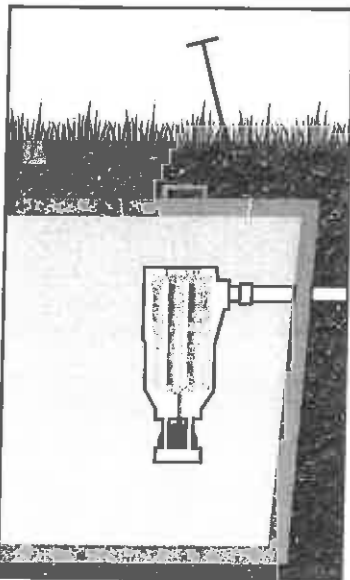

Step 1:

- Locate the outlet of the septic tank.

**DO NOT USE PLUMBING
 WHEN FILTER IS REMOVED**

**USE RUBBER GLOVES
 WHEN CLEANING FILTER**

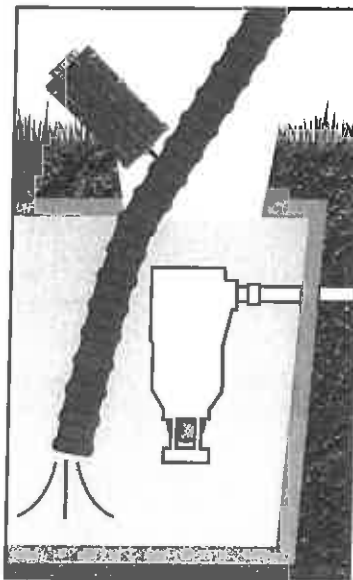

Step 2:

- (A) Remove tank cover and pump if necessary.
- (B) Pull the filter out of the housing.
- (C) Hose off the filter over the septic tank. Make sure all solids fall back into the septic tank.

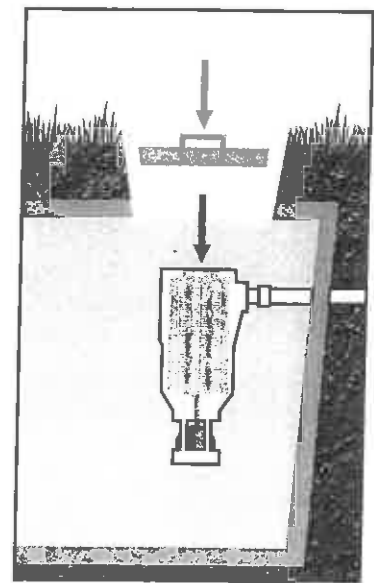

Step 3:

- (A) Insert the filter cartridge back into the the housing making sure the filter is properly aligned and completely inserted.
- (B) Replace septic tank cover

INSTALLATION INSTRUCTIONS

PL-525/PL-625 FILTER

PL-122/PL-525/PL-625 FEATURES & BENEFITS



PL-625



PL-525



PL-122

The PL-122/PL-525/625 Effluent Filter should operate efficiently for several years under normal conditions before requiring cleaning. It is recommended that the filter be cleaned every time the tank is pumped or at least every three years. If the installed filter contains an optional alarm, the owner will be notified by an alarm when the filter needs servicing. Servicing should be done by a certified septic tank pumper or installer.

Features & Benefits:



- Rated for 10,000 GPD
- PL-122 = 122 Linear Feet of 1/16" Filtration
PL-525 = 525 Linear Feet of 1/18" Filtration
PL-625 = 625 Linear Feet of 1/32" Filtration
- Accepts 4" and 6" SCHD. 40 pipe
- Built in Gas Deflector
- Automatic Shut-Off Ball when Filter is Removed
- Alarm Accessibility
- Accepts PVC Extension Handle

RECOMMENDED PRODUCTS

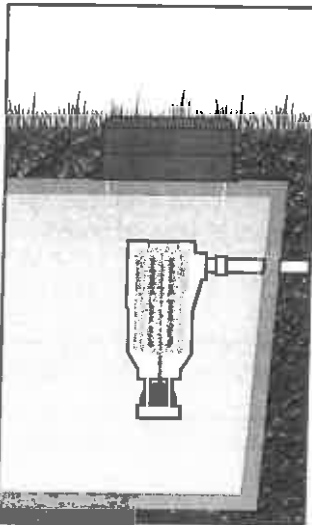

Risers & Riser Covers

Polylok risers bring your septic tank cover to grade. This allows locating and servicing your filter easier and time saving by eliminating digging to find tank entrance.



Extend & Lok™

Polylok Extend & Lok™ is a simple, easy to use solution that can extend the inlet or outlet pipe and make filter and/or baffle installation a snap. Fits 3" and 4" pipe.

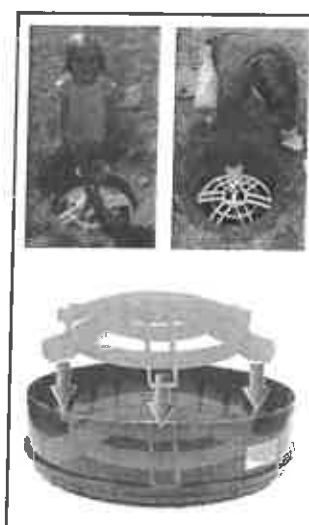

Riser Safety Screens

Polylok safety screens prevent tragic accidents from happening by children and pets falling into open septic tank entrances.

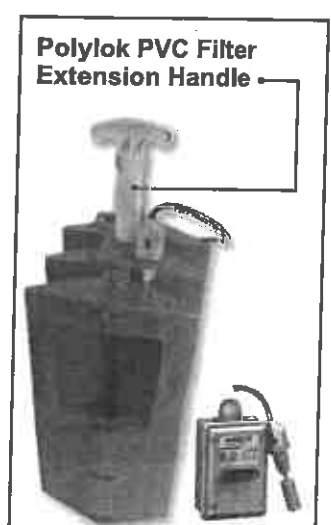

Polylok PVC Filter Extension Handle

Filter Alarm Panel and SmartFilter™ Control Switch

Polylok filter alarm panels and switches provide a visual and audible notification of impending filter and tank servicing.

For a full list of Polylok products please visit our web site at: www.polylok.com

PL-625 Effluent Filter

POLYLOK
PROVEN TECHNOLOGY



PL-625 Test Results:

Testing on the performance of the Polylok PL-625 Effluent Filter took place at a 140,000 square foot facility located at 3 Fairfield Blvd. Wallingford, CT. The facility tested, is a light manufacturing and sales facility with two cafeterias and over 70 employee's.

Testing was performed over a six month period which began in November 2009 and ran through April 2010. The test sample was taken at Test Tank #1, (1 of 2 Test Septic Tanks.) Testing was started when all effluent was diverted thru a valve to the Test Tank #1.

Because of the amount of employees at this facility this test tank was loaded at approximately 10 times the capacity of a standard residential 4 bedroom home.

Results of testing are as follows:

Biochemical Oxygen Demand (BOD):

Before: 697.2

After: 313.3

Total Suspended Solids (TSS):

Before: 1610.

After: 120.

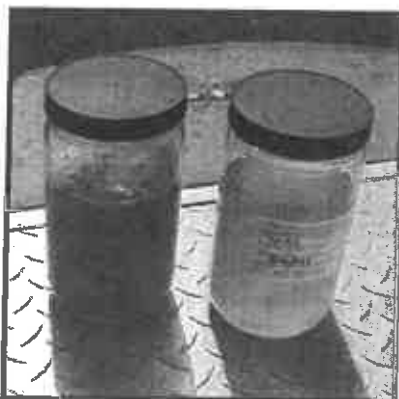

PL-625 Features:

- Rated for 10,000 GPD (gallons per day).
- 625 linear feet of 1/32" filtration.
- Accepts 4" and 6" SCHD 40 pipe.
- Built in gas deflector.
- Automatic shut-off ball when filter is removed.
- Alarm accessibility.
- Accepts PVC extension handle.



Report Date..... 9-Sep-11
EML Project ID..... 110902-POL

Date Sampled..... 2-Sep-11
Date Submitted..... 2-Sep-11

POLYLOK TEST FACILITY
3 Fairfield Blvd
Wallingford, CT 06492

Attn: Mr. Peter Gavin

Values in mg/L unless otherwise noted.
ND = Not Detected. NR = Not Required.

	PL-625 Before	PL-625 After
Biochemical Oxygen Demand	4669.	245.5
Total Suspended Solids	31,100.	104.

7A:BB

Technical Reviewer:

Title:

Transcript Reviewer:

Title:



ENVIRONMENTAL MONITORING LABORATORY, INC.



The Public Health and Safety Organization

NSF Product and Service Listings

These NSF Official Listings are current as of **Wednesday, April 06, 2016** at 12:15 a.m. Eastern Time. Please contact NSF International to confirm the status of any Listing, report errors, or make suggestions.

Alert: NSF is concerned about fraudulent downloading and manipulation of website text. Always confirm this information by clicking on the below link for the most accurate information: <http://info.nsf.org/Certified/Wastewater/Listings.asp?Standard=046&Company=79580&>

NSF/ANSI 46 Evaluation of Components and Devices Used in Wastewater Treatment Systems

Polylok Inc.
3 Fairfield Boulevard
Wallingford, CT 06492
United States
877-765-9565
203-265-6340

Facility : Cheshire, CT

Septic Tank Effluent Filters[1]

PL-122	PL-250	PL-525	PL-625	PL-68
--------	--------	--------	--------	-------

[1] Performance tested using bead size 0.338 cm ± 0.005 cm (1/8" ± 0.002"). Meets the full requirements of NSF/ANSI 46-2010.

Facility : Evansville, IN

Septic Tank Effluent Filter Components[1]

A101-12x20	A101-12x28	A101-12x36	A101-8x18	A101-8x26
A101-8x32	A1801-4x18[4]	A1801-4x22[4] [5]	A301-12x20	A301-12x28
A301-12x36	A301-8x18	A301-8x26	A301-8x32	

[1] Septic Tank Effluent Filter Components are exempt from bearing the NSF Component Mark and shall bear the NSF Unit Mark.

- [4] Filter cartridges Certified in ABS and PVC materials.
 [5] Failure sensing and signaling equipment of this product not evaluated by NSF.

Septic Tank Effluent Filters[2] [3]

A100-12x20	A100-12x20-VC	A100-12x20/BALL	A100-12x28-VC	A100-12x36-VC
A100-8x18-VC	A100-8x26-VC	A100-8x32-VC	A1800-4x18-30142-68	A1800-4x18-VT-B35
A1800-4x18-VT-B40	A1800-4x18-VTF-B35	A1800-4x18-VTF-B40	A1800-4x22-30142-68	A1800-4x22-VT-B35
A1800-4x22-VT-B40	A1800-4x22-VTF-B35	A1800-4x22-VTF-B40	A300-12x20	A300-12x20-VC
A300-12x20/BALL	A300-12x28-VC	A300-12x36-VC	A300-8x18-VC	A300-8x26-VC
A300-8x32-VC	A600-12x20	A600-12x20/BALL	A600-12x28-VC	A600-12x36-VC
A600-8x18-VC	A600-8x26-VC	A600-8x32-VC		

- [2] Suffix VC denotes a filter cartridge with Versa-Case assembly.
 [3] Performance tested using bead size $0.338 \text{ cm} \pm 0.005 \text{ cm}$ ($1/8" \pm 0.002"$). Meets the full requirements of NSF/ANSI 46-2010.

NOTE: All filters come Smartfilter ready.

Number of matching Manufacturers is 1

Number of matching Products is 52

Processing time was 0 seconds

Equalization Tank Pump.

EFFLUENT AND DRAIN WATER PUMPS

MYERS® ME45 SERIES

The Myers ME45 series effluent pumps are designed to meet the demand of residential septic tanks or sump applications. This powerful 1/2 HP pump provides flow and head required for demanding dosing systems and drainage applications.

APPLICATIONS

Effluent removal, sump drainage, water transfer, flood control

SPECIFICATIONS

Capacities – 87 GPM (329 LPM)

Shut-off Head – 44' (13.41 m)

Operation – Manual

Max. Spherical Solids – 3/4" (19 mm)

Liquids Handling – Domestic effluent and drain water

Intermittent Liquid Temperature –
Up to 140°F (60°C)

Motor/Electrical Data – 1/2 HP, 3450 RPM, oil-filled, permanent split capacitor type, 115V, 8.6A, 1Ø, 60Hz; 230V, 4.3A, 1Ø, 60Hz

Acceptable pH Range – 5-9

Specific Gravity – .9-1.1

Viscosity – 28-35 SSU

Discharge, NPT – 2" (50.8 mm)

Housing – Cast iron

Minimum Sump Diameter –
Simplex: 24" (61.0 cm)

Duplex: 36" (91.4 cm)

Power Cord – 20', 16/3, SJTW



Features a
Cast Iron Impeller

FEATURES

Powerful Torque

High-torque, permanent split capacitor (PSC) motor; no starting switches or relays to wear out

Rugged and Cool

Rugged-built, oil-filled motor for continuous bearing lubrication and maximum heat dissipation

Seal Protection

Upper and lower ball bearing and heavy duty Type 6 seal for added pump life

Thermal Protection

Heat sensor overload protection with automatic reset when motor cools to a safe operating temperature

MYERS® M45 SERIES

ORDERING INFORMATION

Catalog Number	HP	Volts	Phase/Cycles	Amps	Discharge Size	Switch Type	Cord Length	Approx. Wt. Lbs.
ME45MC-11	1/2	115	1/60	8.6	2"	Manual	20'	58
ME45MC-21	1/2	230	1/60	4.3	2"	Manual	20'	58

DIMENSIONS

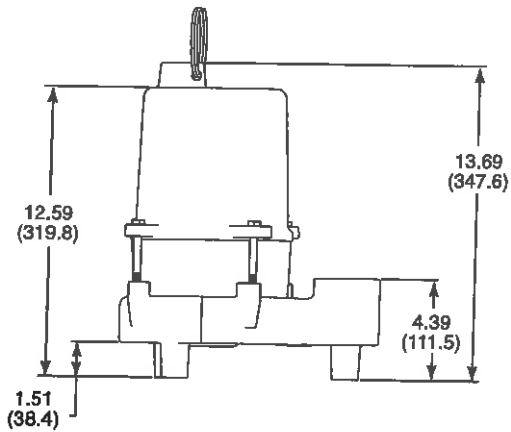
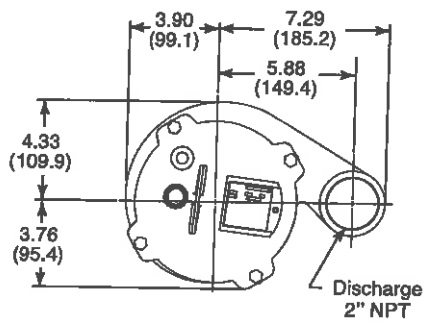

PUMP PERFORMANCE

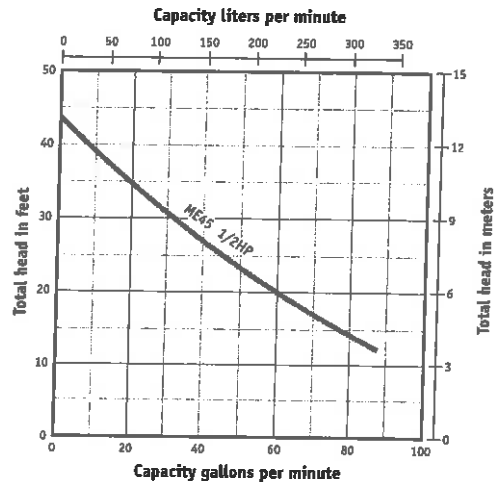

MYERS® M45 SERIES

SPECIFICATIONS

Effluent Pumps – Pump(s) shall be F. E. Myers ME45 Series effluent pump selected in accordance with the following design criteria:

Number of Pumps:	_____
Primary Design Flow:	_____
Primary Design Head:	_____
Minimum Shut-off Head:	44'
Motor Horsepower:	1/2
Motor Speed:	3450 RPM
Electrical:	115 Volts, 1Ø, 60 Hz or 230 Volts, 1Ø, 60 Hz

Pump – The pump shall be designed to handle septic tank effluent and be capable of passing 3/4 inch spherical solids. The pump shall be capable of handling liquids with temperatures to 140°F intermittent.

Motor – The pump motor shall be of the submersible type rated 1/2 hp at 3450 RPM and shall be for _____ 115 volts or _____ 230 volts single phase, 60 cycles. Single phase motor shall be PSC motor with no relays or starting switches. Stator winding shall be of the open type with Class B insulation rated for 130°C maximum operating temperature. The winding housing shall be filled with clean dielectric oil to lubricate bearings and seals, and transfer heat from the windings to the outer shell.

The motor shall be capable of operating over the full range of the performance curve without overloading the motor and causing any objectionable noise or vibration. The motor shall have two bearings to support the rotor; an upper sleeve bearing to accommodate radial loads and a lower sleeve bearing with thrust pad to take thrust and radial loads.

A heat sensor thermostat and overload shall be attached to the top end of the motor windings and shall be wired in series with the windings to stop the motor if the motor winding reaches 200°C. The overload thermostat shall reset automatically when the motor cools to a safe operating temperature.

Power Cord – The motor power cord shall be 20 feet SJTW type. The power and switch cords shall be of the positive sealing type. The power and switch cable connections shall be sealed at the motor entrance by means of a compression nut which serves to make a positive electrical connection and prevent water from entering the cable jacket and motor housing.

Shaft Seal – The motor shall be protected by a rotating mechanical shaft seal. The seals shall have carbon and ceramic seal faces lapped to a tolerance of 1 -3 light band. Metal parts and springs for seals shall be 18 - 8 series stainless steel.

Pump Impeller – The pump impeller shall be of the two vane semi-open type. The impeller shall be constructed of cast iron.

Motor Housing – The motor housing castings shall be of high tensile strength Class 30 gray cast iron. Castings shall be painted with a high quality, 1/8" thick (per UL778) baked epoxy spray for corrosion protection.

Pump Case – The pump case shall be a high efficiency volute design capable of passing 3/4 inch spherical solids. The pump volute shall be constructed of cast iron.

Fasteners – All exposed fasteners shall be of 300 series stainless steel.

EFFLUENT AND DRAIN WATER PUMPS

MYERS® M45 SERIES



USA
293 WRIGHT STREET, DELAVAN, WI 53115 WWW.FEMYERS.COM
PH: 888-987-8677 ORDERS FAX: 800-426-9446

CANADA
490 PINEBUSH ROAD, UNIT 4, CAMBRIDGE, ONTARIO N1T 0A5
PH: 800-363-7867 ORDERS FAX: 888-606-5484

Because we are continuously improving our products and services, Pentair reserves the right to change specifications without prior notice.

© 2014 Pentair Ltd. All Rights Reserved.

M9105SSE (05/01/14)

Recirculation Pump

STA-RITE® ST.E.P Plus Series

4" high-head multi-stage submersible effluent pumps



The STEP Plus 4" submersible filtered effluent pumps in 10, 20, 30 and 50 GPM models offer dependable performance and value for high pressure filtered effluent applications.

These STEP Plus pumps will handle "dry run" conditions.

The 10, 20, 30 and 50 GPM are industry standard 3-3/4" in diameter.

APPLICATIONS

Filtered Effluent... for residential, commercial, and agricultural use.

SPECIFICATIONS

Shell – Stainless steel

Discharge –
10, 20 and 30 GPM models:
fiberglass-reinforced thermoplastic;
50 GPM models: stainless steel

Discharge Bearing – Nylatron®

Impellers – Engineered composite

Diffusers – Engineered composite

Suction Caps – Engineered composite with stainless steel wear ring

Thrust Pads – Proprietary spec.

Shaft and coupling – Stainless steel 300 grade

Intake – Engineered composite

Intake Screen – Polypropylene

Jacketed Cord – 600 Volt "SOOW" or 300 Volt "SJOW" jacketed 10' leads (2-wire with ground); optional 20', 30', 50' and 100' lengths available

FEATURES

Proven "Floating Impeller" Staging System – Incorporates 1st-in-class performance, sand handling and thrust management staging system with the industry exclusive "dry-run" design element. Reinforced engineered composites and stainless steel, offering high resistance to corrosion and abrasion.

Discharge – Tested-tough, fiberglass-reinforced thermoplastic, with proven internal check valve. Large wrench flats and rope hole.

Shell – Stainless steel pump shell offers high corrosion resistance.

Shaft – Hexagonal 3/8", 300-grade stainless steel pump shaft; offers generous impeller drive surfaces.

Shaft Bearing – Exclusive self-lubricating Nylatron bearing resists wear surface from sand.

Motor Bracket – Tested-tough, fiberglass-reinforced thermoplastic; incorporates an integral suction screen.

In order to provide the best products possible, specifications are subject to change.

STA-RITE® ST.E.P Plus Series

4" high-head multi-stage submersible effluent pumps

ORDERING INFORMATION						
CATALOG NUMBER	HP	STAGES	MAX. LOAD AMPS	VOLTS	PHASE/ CYCLES	CORD LENGTH
STEP10	1/2	7	12.0	115	1/60	10'
STEP10X100FT-05121	1/2	7	12.0	115	1/60	100'
STEP10X30FT	1/2	7	12.0	115	1/60	30'
STEP10X50FT	1/2	7	12.0	115	1/60	50'
STEP20	1/2	5	12.0	115	1/60	10'
STEP20X100FT-05121	1/2	5	12.0	115	1/60	100'
STEP20X30FT	1/2	5	12.0	115	1/60	30'
STEP20X50FT	1/2	5	12.0	115	1/60	50'
STEP30-05121	1/2	3	9.5	115	1/60	10'
STEP30X100FT-05121	1/2	3	12.0	115	1/60	100'
STEP30X30FT-05121	1/2	3	12.0	115	1/60	30'
STEP30X50FT-05121	1/2	3	12.0	115	1/60	50'
STEP30-05221	1/2	3	4.7	230	1/60	10'
STEP30X100FT-05221	1/2	3	4.7	230	1/60	100'
STEP30X30FT-05221	1/2	3	4.7	230	1/60	30'
STEP30X50FT-05221	1/2	3	4.7	230	1/60	50'
STEP30-10221	1	5	9.1	230	1/60	10'
STEP30X100FT-10221	1	5	9.1	230	1/60	100'
STEP30X30FT-10221	1	5	9.1	230	1/60	30'
STEP30X50FT-10221	1	5	9.1	230	1/60	50'
STEP30-15221	1-1/2	6	11.0	230	1/60	10'
STEP30X100FT-15221	1-1/2	6	11.0	230	1/60	100'
STEP30X30FT-15221	1-1/2	6	11.0	230	1/60	30'
STEP30X50FT-15221	1-1/2	6	11.0	230	1/60	50'
STEP50-10221	1	3	9.1	230	1/60	10'
STEP50X100FT-10221	1	3	9.1	230	1/60	100'
STEP50X30FT-10221	1	3	9.1	230	1/60	30'
STEP50X50FT-10221	1	3	9.1	230	1/60	50'
STEP50-15221	1-1/2	4	11.0	230	1/60	10'
STEP50X100FT-15221	1-1/2	4	11.0	230	1/60	100'
STEP50X30FT-15221	1-1/2	4	11.0	230	1/60	30'
STEP50X50FT-15221	1-1/2	4	11.0	230	1/60	50'

STA-RITE® ST.E.P Plus Series

4" high-head multi-stage submersible effluent pumps

PUMP PERFORMANCE - 10 GPM

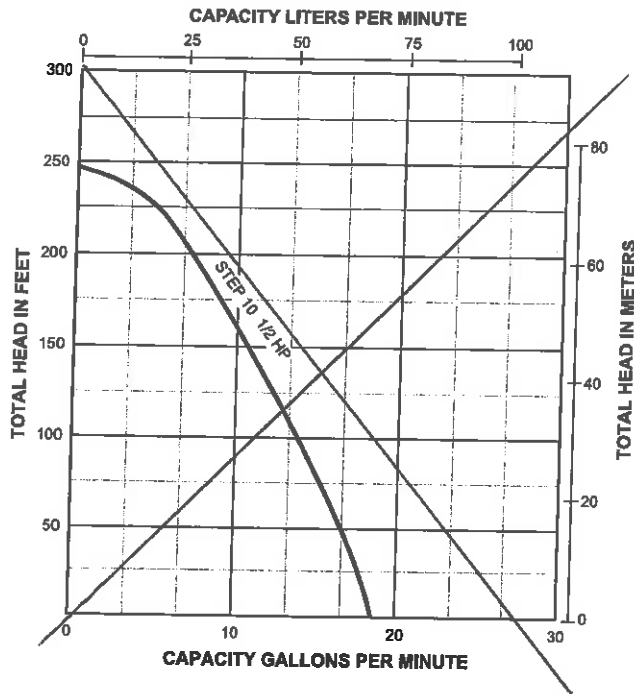

PUMP PERFORMANCE - 20 GPM

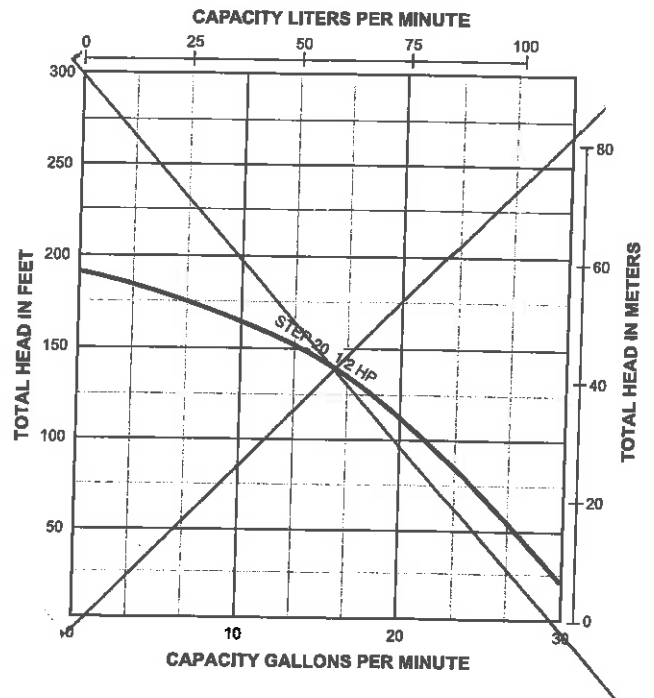

PUMP PERFORMANCE - 30 GPM

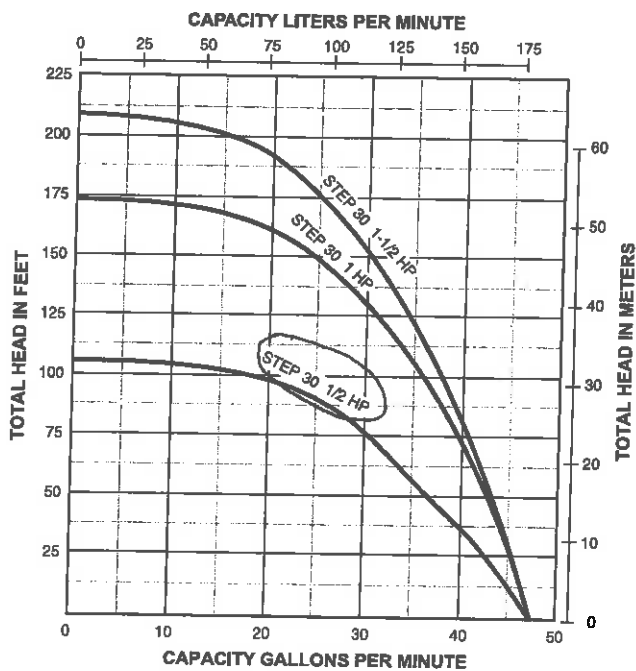

PUMP PERFORMANCE - 50 GPM

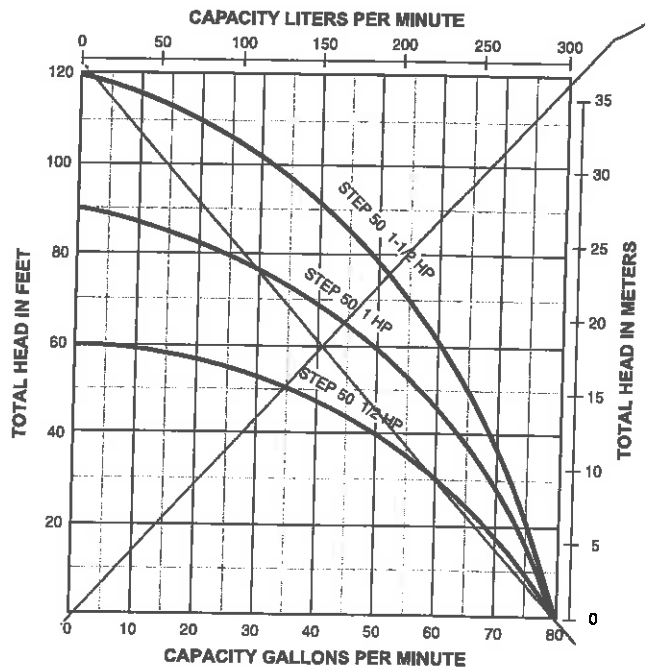

STA-RITE® ST.E.P Plus Series

4" high-head multi-stage submersible effluent pumps

OUTLINE DIMENSIONS

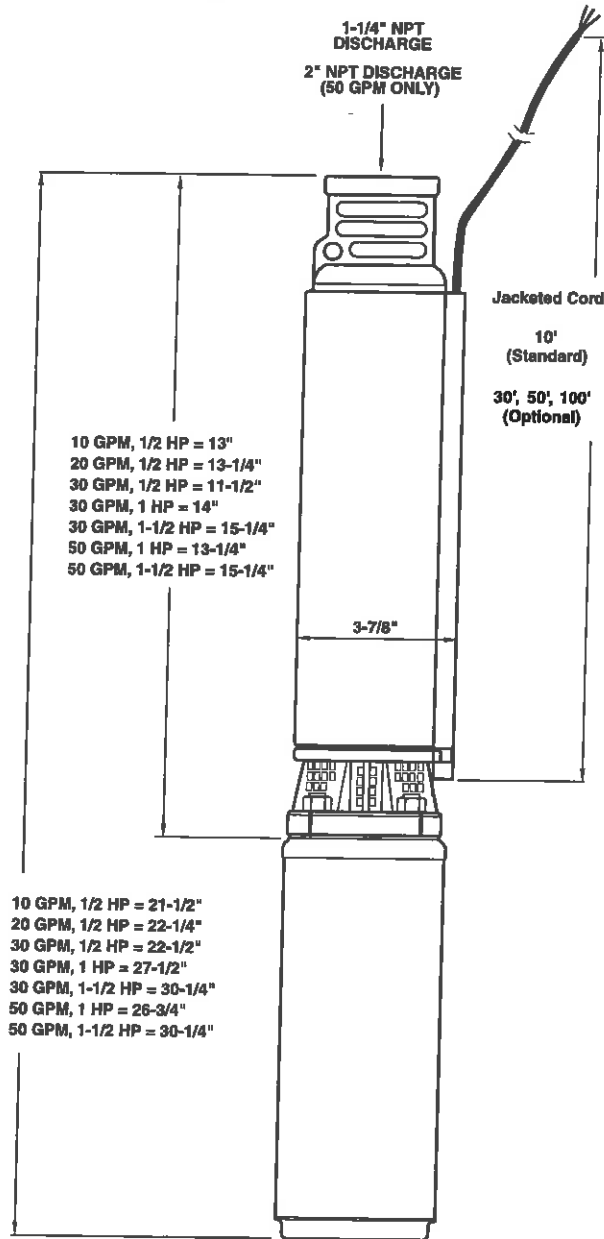

Dimensions (in inches) are for estimating purposes only.



293 WRIGHT STREET, DELAVAN, WI 53115 WWW.STA-RITE.COM PH: 888-782-7483 ORDERS FAX: 800-426-9446
Because we are continuously improving our products and services, Pentair reserves the right to change specifications without prior notice.

S11411WS (09/10/14)

E-Z Treat
Mod.#600

20PSI @ Spray Manifold or 46 Ft Head
@20 PSI Flow Per Spray Nozzle 1.7 GPM
8 Nozzles Per Mod.#600
Total Flow Required 13.6 GPM

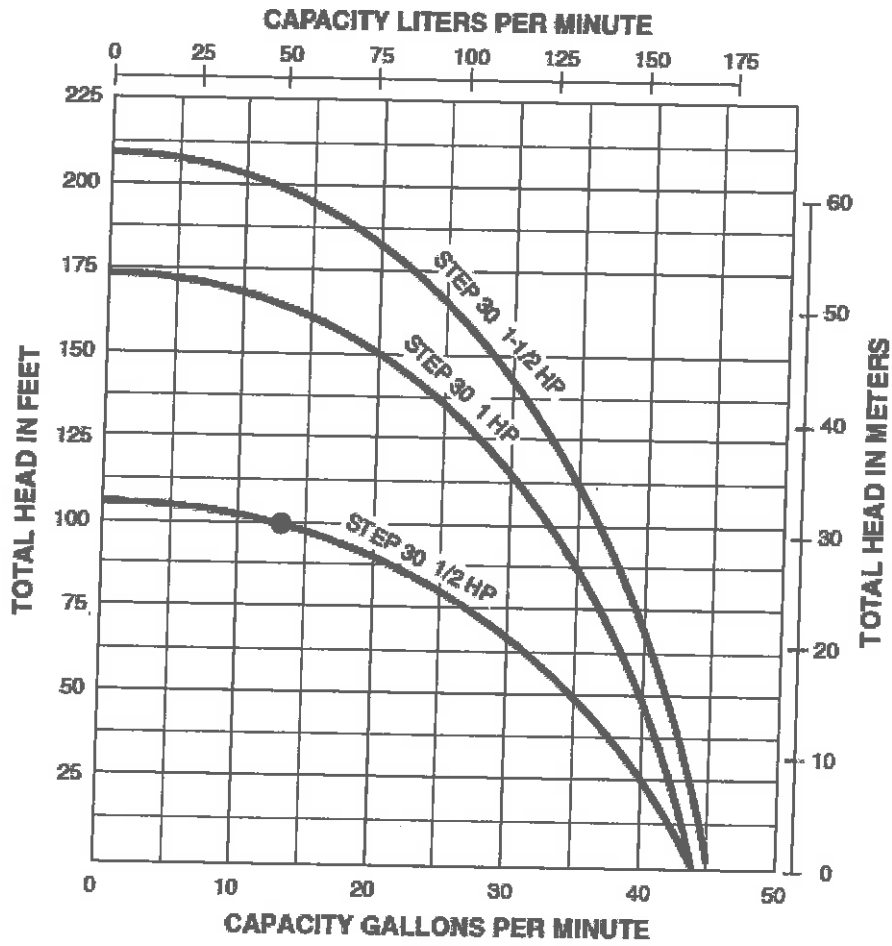

Trusted. Tested. Tough.™

Product information presented here reflects conditions at time of publication. Consult factory regarding discrepancies or inconsistencies.

Field Dosing Pump

ZOELLER®

PUMP COMPANY

SECTION: 2.15.100
FM2786
0517
Supersedes
0515

TECHNICAL DATA SHEET

HIGH HEAD FLOW-MATE SERIES

Models 185/4185, 186/4186, 188/4188, 189/4189, 191
Submersible Effluent Pumps

PRODUCT SPECIFICATIONS

MOTOR	Horse Power	1 - 2 HP
	Voltage	200 - 575
	Phase	1 or 3 Ph
	Hertz	60 Hz
	RPM	3450
	Type	Permanent split capacitor or 3 Ph
	Insulation	Class B/185 & 4185 , Class F/186-191 & 4186-4189
	Amps	3.3 - 20.5
	PUMP	Operation
Auto On/Off Points		15-3/4" (400 mm) / 5-1/4" (133 mm)
Discharge Size		1-1/2" NPT (optional 2" or 3" flange)
Solids Handling		3/4", 5/8" (model 191) (19 mm 15 mm) spherical solids
Cord Length		20' (6 m) standard
Cord Type		1 Ph: UL listed 3-wire neoprene cord & plug or 3 Ph: 4-wire with no plug
Max. Head		137' (42 m)
Max. Flow Rate		145 GPM (549 LPM)
Max. Operating Temp.		130 °F (54 °C) (model WD189 120 °F [49 °C])
Cooling		Oil filled
Motor Protection		Auto reset thermal overload (1 Ph)
MATERIALS	Upper Bearing	Ball bearing
	Lower Bearing	Bell bearing
	Mechanical Seals	Stainless steel, carbon and ceramic
	Impeller Type	Non-clogging vortex
	Impeller	Bronze
	Hardware	Stainless steel
	Motor Shaft	SAE 1117 carbon steel or 416 stainless steel*
	Gasket	Neoprene square ring & gasket

*Single seal models are built with a carbon steel motor shaft, and double seal models are built with a stainless steel motor shaft.

All Class 30 cast iron construction.

NOTE: The sizing of effluent systems normally requires variable level float(s) controls and properly sized basins to achieve required pumping cycles or dosing timers with nonautomatic pumps.

NOTE: See model comparison chart for specific details.

SINGLE SEAL

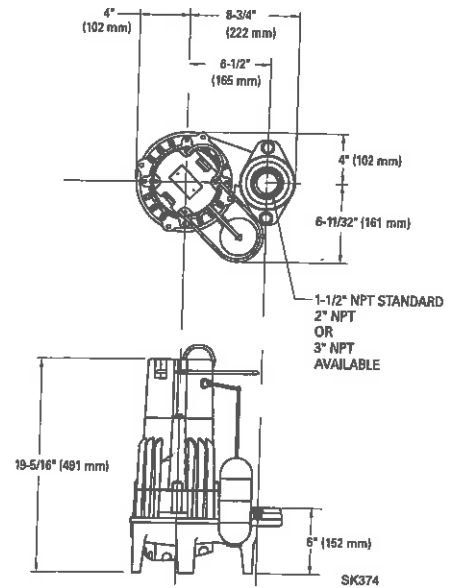

DOUBLE SEAL

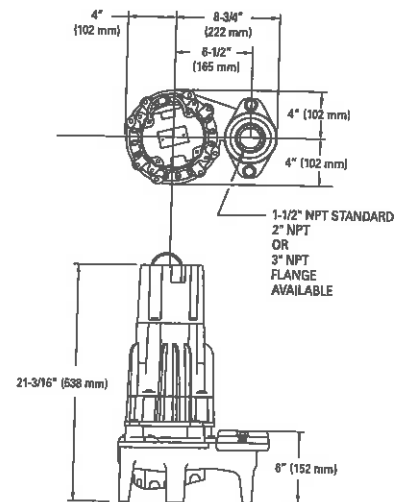

SK1413

TOTAL DYNAMIC HEAD FLOW PER MINUTE

MODELS		185/4185		186/4186		188/4188		189/4189		191	
Feet	Meters	Gal.	Liters	Gal.	Liters	Gal.	Liters	Gal.	Liters	Gal.	Liters
5	1.5	--	--	58	220	145	549	145	549	45	170
10	3.0	--	--	58	220	140	530	140	530	45	170
20	6.1	--	--	58	220	128	484	130.5	494	45	170
30	8.1	85	322	58	220	116	439	120	454	45	170
40	12.2	70	265	58	220	103.5	392	109	413	45	170
50	15.2	51	193	58	220	90	341	97	367	45	170
60	18.3	32	121	58	220	71	269	85	322	45	170
70	21.3	9	34	52	197	51	193	69	261	45	170
80	24.4	--	--	45	170	28	106	51	193	45	170
90	27.4	--	--	30.5	115	2	8	34	129	45	170
100	30.5	--	--	16	60	--	--	17	64	40	151
110	32	--	--	4	15	--	--	--	--	30	114
120	36.6	--	--	--	--	--	--	--	--	20	76
130	39.6	--	--	--	--	--	--	--	--	10	38
Shut-off Head		73 ft. (22m)		114 ft. (35m)		91 ft. (28m)		110 ft. (34m)		137 ft. (42m)	

NOTE: No UL listing for 200/208 single phase pumps, model 186 & 191, or double seal series.

CAUTION: Model 185 should not be subjected to heads less than 30' (9 m) TDH.

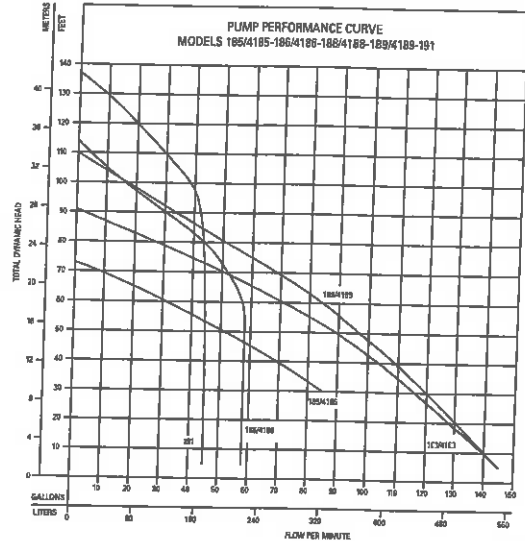

009803

Model	MODEL COMPARISON											BERTHICA FLOWTECH
	Seal	Mode	Volts	Ph	Amps	HP	H ₂	Lbs	Kg	Simplex	Duplex	
D185 / * H185	Single	Auto	230 / 200	1	9.8 / 11.5	1	60	85 / 86	38 / 39	1	--	UL and cCSAus (4)
E185 / E4185	Single / Dbl	Non	230	1	9.8	1	60	85 / 92	38 / 41	2 or 3	4	CSA
* I185 / * I4185	Single / Dbl	Non	200	1	11.5	1	60	85 / 92	38 / 41	2 or 3	4	cCSAus
* F185 / * F4185	Single / Dbl	Non	230	3	7.4	1	60	85 / 92	38 / 41	3 & 5	4 & 5	UL and cCSAus
* J185 / * J4185	Single / Dbl	Non	200	3	7.5	1	60	85 / 92	38 / 41	3 & 5	4 & 5	UL and cCSAus
BE185	Single	Auto	230	1	9.5	1	60	87	39	--	--	UL and cCSAus
* G185 / * G4185	Single / Dbl	Non	460	3	3.7	1	60	85 / 92	38 / 41	3 & 5	4 & 5	UL and cCSAus
* BA185	Single	Non	575	3	3.3	1	60	85	38	3 & 5	4 & 5	cCSAus
D186 / * H186	Single	Auto	230 / 200	1	13.7 / 17.2	1-1/2	60	91	41	1	--	cCSAus (4)
E186 / E4186	Single / Dbl	Non	230	1	13.7	1-1/2	60	90 / 97	40 / 43	2 or 3	4	CSA
* I186 / * I4186	Single / Dbl	Non	200	1	17.2	1-1/2	60	90 / 97	40 / 43	2 or 3	4	cCSAus
* F186 / * F4186	Single / Dbl	Non	230	3	9.2	1-1/2	60	90 / 97	40 / 43	3 & 5	4 & 5	cCSAus
* J186 / * J4186	Single / Dbl	Non	200	3	10.3	1-1/2	60	90 / 97	40 / 43	3 & 5	4 & 5	cCSAus
BE186	Single	Auto	230	1	13.7	1	60	92	42	--	--	CSA
* G186 / * G4186	Single / Dbl	Non	460	3	4.6	1-1/2	60	90 / 97	40 / 43	3 & 5	4 & 5	cCSAus
* BA186 / * BA4186	Single / Dbl	Non	575	3	3.6	1-1/2	60	90 / 97	40 / 43	3 & 5	4 & 5	cCSAus
* D188 / H188	Single	Auto	230 / 200	1	14.0 / 16.8	1-1/2	60	91	41	1	--	CSA
E188 / E4188	Single / Dbl	Non	230	1	14.0	1-1/2	60	90 / 97	40 / 43	2 or 3	4	CSA
* I188 / * I4188	Single / Dbl	Non	200	1	16.8	1-1/2	60	90 / 97	40 / 43	2 or 3	4	cCSAus
* F188 / * F4188	Single / Dbl	Non	230	3	8.9	1-1/2	60	90 / 97	40 / 43	3 & 5	4 & 5	UL and cCSAus
* J188 / * J4188	Single / Dbl	Non	200	3	10.3	1-1/2	60	90	40 / 43	3 & 5	4 & 5	UL and cCSAus
BE188	Single	Auto	230	1	14.0	1-1/2	60	92	42	--	--	CSA
* G188 / * G4188	Single / Dbl	Non	460	3	4.6	1-1/2	60	95 / 97	43 / 43	3 & 5	4 & 5	UL and cCSAus
* BA188	Single	Non	575	3	3.5	1-1/2	60	90	40	3 & 5	4 & 5	cCSAus
D189 / * H189	Single	Auto	230 / 200	1	17.1 / 20.5	2	60	91	41	1	--	UL and cCSAus (1,2,4)
E189 / E4189	Single / Dbl	Non	230	1	17.1	2	60	90 / 97	40 / 43	2 or 3	4	CSA
* I189 / * I4189	Single / Dbl	Non	200	1	20.5	2	60	90 / 97	40 / 43	2 or 3	4	cCSAus
* F189 / * F4189	Single / Dbl	Non	230	3	11.2	2	60	90 / 97	40 / 43	3 & 5	4 & 5	UL and cCSAus
* J189 / * J4189	Single / Dbl	Non	200	3	13.2	2	60	90 / 97	40 / 43	3 & 5	4 & 5	UL and cCSAus
* G189 / * G4189	Single / Dbl	Non	460	3	6.0	2	60	90 / 97	40 / 43	3 & 5	4 & 5	UL and cCSAus
* BA189	Single	Non	575	3	5.8	2	60	90	40	3 & 5	4 & 5	cCSAus
* WD189 / WD4189	Single / Dbl	Auto	230	1	17.1	2	60	93 / 100	42 / 45	1	4	--
E191	Single	Non	230	1	14.5	2	60	87	39	2 or 3	4	cCSAus

* no molded plug (1) UL listed unit available with 20 Amp plug. (2) CSA approval with 20 Amp plug. (3) 20 Amp outlet, P/N 10-0060 must be used. (4) H models are not UL listed.

NOTE: WD models are controlled by an integral variable level pump switch. H, I, J, F, G and BA models do not have a molded plug. Additional cord lengths are available in 25' (8 m) 35' (11 m) and 50' (15 m).

SELECTION GUIDE

1. Integral float operated mechanical switch, no external control required.
2. For automatic use single piggyback variable level float switch or double piggyback variable level float switch. Refer to FM0477.
3. See FM1228 for correct model of simplex control panel.
4. See FM0712 for correct model of duplex control panel.
5. Variable level control switch 10-0743 used as a control activator, specify simplex (3) float or duplex (4) float system. Refer to FM0526.

CAUTION All Installation of controls, protection devices and wiring should be done by a qualified licensed electrician. All electrical and safety codes should be followed including the most recent National Electrical Code (NEC) and the Occupational Safety and Health Act (OSHA).

Recirculation Pump Panel

Branch Circuit Protection Device/Disconnect Means Field Provided - size per manufacturing specifications for pump/motor

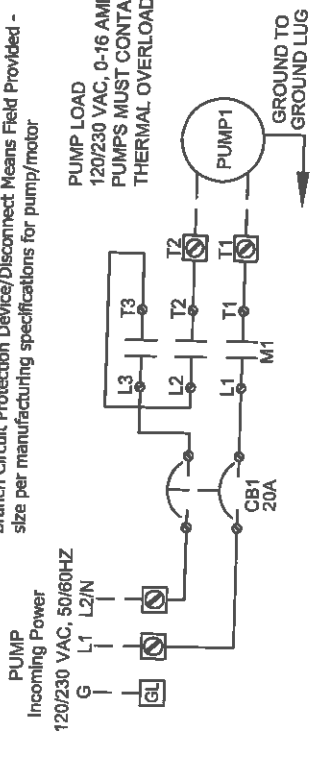

1
F1, F2 FUSE MUST BE REPLACED WITH 1 AMP 5mmX20mm TYPE FAST ACTING 250 V MAX.

This control panel is for timed dosing applications. When the timer enable float is up, the timer will start timing for the duration of the "Off" time and when complete, the pump will start for the duration of the "On" time. Both Off and On times are adjustable. This pattern repeats until the timer enable float lowers and turns off. The Low float acts as a redundant off and will also activate the alarm. If the level reaches the High float switch, the alarm will activate.

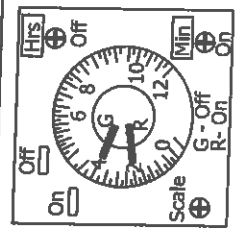
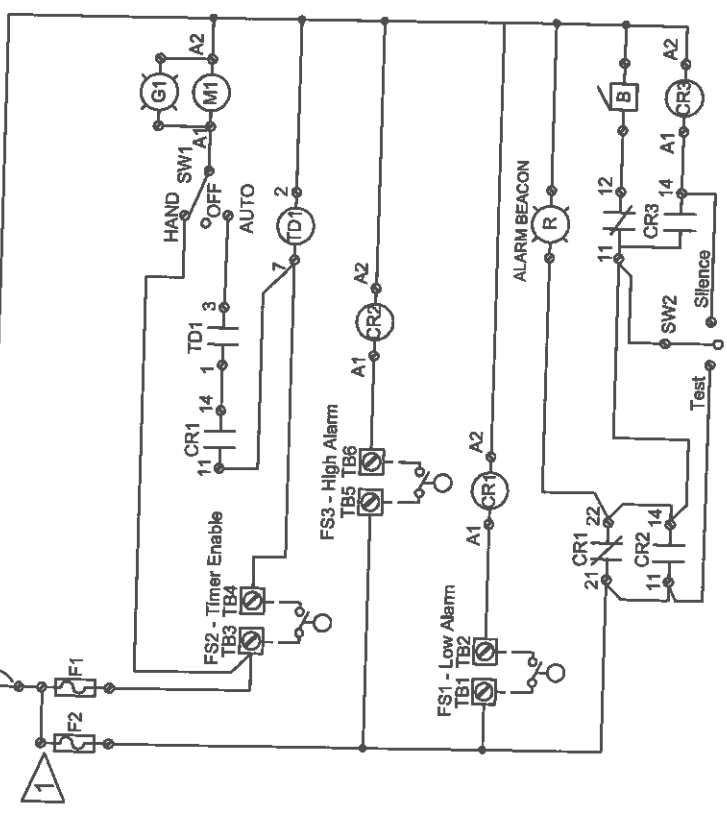

To set the timer, use a screwdriver to change timer Scale (0-12 most common). Use a screwdriver to change the "On" time increments (minutes most common). Use a screwdriver to change the "off" time increments (hours most common). Turn the dial with the Red line to the desired "On" time (this example is 2 minutes). Turn the dial with the Green line to the desired "Off" time (this example is 4 Hours).

TB1 TB2 TB3 TB4 TB5 TB6
FS1 - Low Level Timer Enable
FS2 - Normally Open, Narrow Angle
FS3 - High Level Timer Enable
FS3 - Normally Open, Narrow Angle
FS3 - Normally Open, Wide Angle

Notes:

1. WARNING! Electrical Shock Hazard! Disconnect power before servicing this product. A qualified service person must install and service this product according to applicable electrical and plumbing codes.
2. Install in accordance with National Electric Code, NFPA 70. Seal all boxes, fittings and conduit with appropriate seal devices to prevent moisture and gases from entering enclosure.
3. Connect all grounds to a good ground.
4. Dashed lines represent field wiring - Use minimum 60 deg C Copper Wire
5. Branch Circuit Protection Device/Disconnect Means Field Provided.

--- FIELD WIRING
..... FIELD SUPPLIED
TB TERMINAL BLOCK
Power Wiring = BLK
120VAC Control Wiring = RED
Neutral = WHT
Ground = GRN

AWG/OR CIRCULAR MILL SIZE	TIGHTENING TORQUE INCH POUNDS	EXTERNAL SCREW DRIVER	INTERNAL DRIVE WRENCH
14	36	35	75
12	35	35	75
10	35	35	75
8	40	40	75
6	46	46	110
4	45	45	110
2	60	60	180
1	50	50	150
1/0	60	60	180
2/0	50	50	180

LEGEND

CR	CONTROL RELAY
CB	CIRCUIT BREAKER
GL	GROUND LUG
SW1	HQA SWITCH
SW2	TEST/SILENCE SWITCH
R	ALARM BEACON
B	ALARM BUZZER
M1	MAGNETIC CONTACTOR
G1	PUMP RUN INDICATOR
GL	GROUND LUG
FS	FLOAT SWITCH
TD1	Repeat Cycle Timer



Page Notes:

Model Number: 8113X
DWG Number: 8113X
Quote Number: A20001495
Drawn By: B. Kabunde
Checked By: Ausdn Vandenberg
Date: 4/15/17
Revision Level: 001

Sheet Description:
Production Schematic

Sheet No: 1 1 Of

Recirculation Pump Panel

Terminal Connections

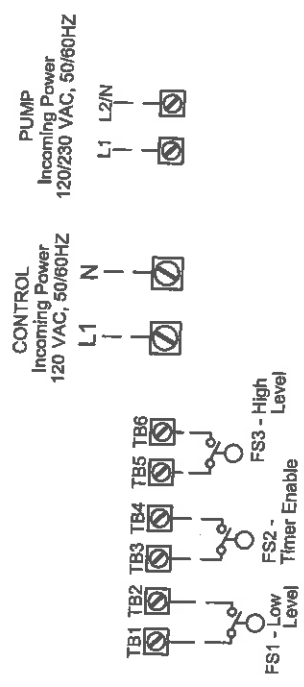

FS1 - Low Level
 FS2 - Timer Enable
 FS3 - High Level

Float Switch Field Wiring
 *FS1 - Normally Open, Narrow Angle
 *FS2 - Normally Open, Wide Angle
 *FS3 - Normally Open, Narrow Angle

--- FIELD WIRING
 FIELD SUPPLIED
 TB TERMINAL BLOCK

Power Wiring = BLK
 120VAC Control Wiring = RED
 Neutral = WHT
 Ground = GRN

AWG/OR CIRCULAR MILL SIZE	TIGHTENING TORQUE IN INCH POUNDS	EXTERNAL SCREW DRIVER	DRIVE WRENCH
14	35	75	
12	35	75	
10	35	75	
8	40	75	
6	45	110	
4	45	110	
2	50	150	
1	50	150	
1/0	50	150	
2/0	50	180	

LEGEND	
CR	CONTROL RELAY
CB	CIRCUIT BREAKER
GL	GROUND LUG
SW1	HOM SWITCH
SW2	TEST/SILENCE SWITCH
R	ALARM BEACON
B	ALARM BUZZER
M1	MAGNETIC CONTACTOR
G1	PUMP RUN INDICATOR
GL	GROUND LUG
FS	FLOAT SWITCH
TD1	Repeat Cycle Timer

ALDERON Industries
 Leading Edge Control Products
 181 10TH ST. SOUTH
 HAWLEY PA, 18428

Model Number: 8113X	Quote Number: AZ0001495	Drawn By: B. Kabunde	Checked By: Austin Vandenberg	Date: 4/15/17
Revision Level: 001				

Sheet Description:
 Terminal Connection

Sheet No:
1 1
 Of

Notes:

1. WARNING! Electrical Shock Hazard! Disconnect power before servicing this product. A qualified service person must install and service this product according to applicable electrical and plumbing codes.
2. Install in accordance with National Electric Code, NFPA 70. Seal all boxes, fittings and conduit with appropriate seal devices to prevent moisture and gases from entering enclosure.
3. Connect all grounds to a good ground.
4. Dashed lines represent field wiring - Use *minimum* 60 deg C Copper Wire
5. Branch Circuit Protection Device/Disconnect Means Field Provided.

EZ Series® - Single Phase Simplex

Single phase, simplex demand dose or timed dose float controlled system for pump control and system monitoring.

The EZ Series® simplex control panel is designed to control one 120, 208, 240 VAC single phase pump in water and sewage installations.

The EZ Series® simplex control panel features a backlit LCD display on the inside of the front cover for programming and system monitoring.

The panel configuration can be easily converted in the field to either a timed dose or demand dose.

The optional post models include an access door. The post can be mounted in the ground directly, over a 4X4, or conduit. The panel is also available with optional duo alarm to meet the needs of various applications.

PANEL COMPONENTS

1. **Enclosure base** measures 10 X 8 X 6 inches (25.4 X 20.32 X 15.24 cm), NEMA 4X (ultraviolet stabilized thermoplastic with removable mounting feet for outdoor or indoor use). Includes locking latch as standard. **Note:** Options, voltage, and amp range selected may change enclosure size and component layout.
2. **Red Alarm Beacon** provides visual check of alarm condition.
3. **Exterior Alarm Test/Silence Switch** allows horn and light to be tested and horn to be silenced in an alarm condition. Alarm automatically resets once alarm condition is cleared.
4. **Circuit Breaker** provides pump power disconnect and branch circuit protection.
5. **Circuit Breaker** provides control/alarm power disconnect.
6. **Power Relay** controls pump by switching electrical lines.
7. **Float Connection Terminal Block**
8. **Incoming Control/Alarm Power & Pump Power Terminal Block**
9. **Control Power Indicator** indicator light illuminates if control power is present in panel.
10. **Alarm Power Indicator** indicator light illuminates if alarm power is present in panel.
11. **Pump Run Indicator** will illuminate when pump is called to run.
12. **Backlit LCD Display** shows system information including: pump elapsed time (hh:mm), pump events (cycles), and alarm condition (counts).
13. **Menu/Enter Button** used for viewing panel settings.
14. **Set/Change Button** used for programming panel settings.
15. **Pump Push To Run Momentary Switch** - Pump activates when pressed
16. **Alarm Horn** provides audio warning of alarm condition (83 to 85 decibel rating). (Located inside panel on cover, not shown)
17. **Control and Alarm Power** - shorted condition indicators.

NOTE: Schematic/Wiring Diagram and Pump Specification Label are located inside the panel.

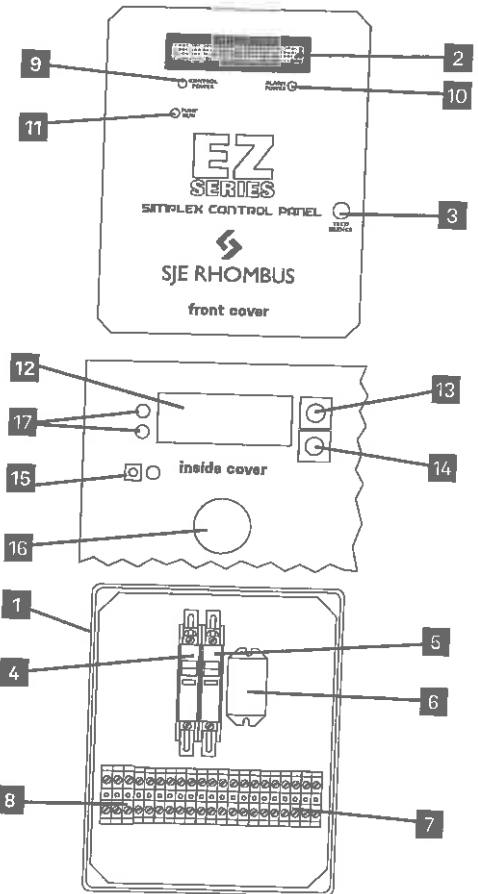

Model Shown EZS21W914X6A8AC10E15A (Inside view)

Reg. Cdn Pat. & TM Off

FEATURES

- Entire control system (panel and switches) is UL Listed to meet and/or exceed industry safety standards
- Dual safety certification for the United States and Canada
- Standard package includes:
 - Demand Dose** - three control switches
 - Timed Dose** - two control switches
- Available with EZconnex® float system
- Complete with step-by-step installation instructions
- Five-year limited warranty



SJE RHOMBUS

1-888-DIAL-SJE • 1-218-847-1317

1-218-847-4617 Fax

email: customer.service@sjeinc.com

www.sjrhombus.com

B.1

California Prop 65 requires the following: WARNING Cancer and Reproductive Harm - www.P65Warnings.ca.gov

SEE REVERSE SIDE FOR ORDERING INFORMATION.
SEE PRICE BOOK FOR LIST PRICE.

EZS **1 & 2** **1** **W** **9** **1** **4** **H** **3A 6A 8AC 10E 15A**

MODEL EZS

- MODEL TYPE**
 1 = SPLX TIMED DOSE.....\$718.00
 2 = SPLX DEMAND DOSE.....\$743.00
1 for Equalization Pump
2 for Field Dosing Pump
- ALARM PACKAGE**
 1 = alarm package (includes test/normal/silence switch, fuse, red light & horn)Base
- ENCLOSURE RATING**
 W = NEMA 4X.....Base
- STARTING DEVICE**
 1 = 120/208/240 VAC.....Base
 9 = 120 VAC.....Base
- PUMP FULL LOAD AMPS**
 0 = 0-7 FLA.....Base
 1 = 7-15 FLA.....Base
 2 = 15-20 FLA.....Base
- PUMP DISCONNECTS**
 4 = circuit breaker(s)
 120 VAC (must select starting device option 9).....\$35.00
 120/208/240 VAC (must select starting device option 1).....\$70.00
- SWITCH APPLICATIONS**
 H = floats (Timed dose = timer enable and alarm / Demand dose = stop, start, and alarm) (select 17 option).....Base
 E = EZconnex® float switch system (select 33 or 36 option)
 (Time dose).....-\$50.00
 (Demand dose).....-\$75.00
 X = no float
 (Time dose).....-\$50.00
 (Demand dose).....-\$75.00
- Note:** Pump down applications only.

OPTIONS Listed below

Total Options
TOTAL LIST PRICE

CODE DESCRIPTION	LIST PRICE	CODE DESCRIPTION	LIST PRICE
<input type="checkbox"/> 1J Duo alarm inputs.....	\$20.00	<input checked="" type="checkbox"/> 18A Timer override float (timed dose float panel only).....	\$25.00
<input checked="" type="checkbox"/> 3A Alarm Flasher (included as standard).....	\$0.00	<input type="checkbox"/> 22G 2 1/2" hub installed with 6 hole cord seal.....	\$73.00
<input type="checkbox"/> 4A Redundant off (timed dose float panel only) (select 4D if floats are required).....	\$0.00	<input type="checkbox"/> 33D EZconnex® 3-Port, 25', w/10' floats (3) /pipe clamp *.....	\$268.00
<input type="checkbox"/> 4D Redundant off float (must select 4A option) (must select 17 option).....	\$25.00	<input type="checkbox"/> 33E EZconnex® 3-Port, 50', w/10' floats (3) /pipe clamp *.....	\$304.00
<input checked="" type="checkbox"/> 6A Auxiliary alarm contact, form A (included as standard).....	\$0.00	<input type="checkbox"/> 33G EZconnex® 3-Port, 25', w/20' floats (3) /pipe clamp *.....	\$288.00
<input checked="" type="checkbox"/> 8AC Display board includes: ETM counter, events (cycles) counter, alarm counter (included as standard).....	\$0.00	<input type="checkbox"/> 33H EZconnex® 3-Port, 50', w/20' floats (3) /pipe clamp *.....	\$324.00
<input checked="" type="checkbox"/> 10E Lockable latch - NEMA 4X (included as standard).....	\$0.00	<input type="checkbox"/> 35D EZconnex® 4-Port, 25', w/10' floats (4) /pipe clamp * (timed dose only).....	\$379.00
<input type="checkbox"/> 10P Mounting post (factory installed with 2.5" cord seal).....	\$110.00	<input type="checkbox"/> 35E EZconnex® 4-Port, 50', w/10' floats (4) /pipe clamp * (timed dose only).....	\$424.00
<input checked="" type="checkbox"/> 15A Control / Alarm circuit breaker (included as standard).....	\$0.00	<input type="checkbox"/> 35G EZconnex® 4-Port, 25', w/20' floats (4) /pipe clamp * (timed dose only).....	\$405.00
<input type="checkbox"/> 16A 10' cord in lieu of 20' (per float).....	-\$2.00	<input type="checkbox"/> 35H EZconnex® 4-Port, 50', w/20' floats (4) /pipe clamp * (timed dose only).....	\$450.00
<input type="checkbox"/> 16B 15' cord in lieu of 20' (per float).....	-\$1.00	<input type="checkbox"/> 36D EZconnex® 3-Port, 25', w/10' floats (2) /pipe clamp, sealing plug *.....	\$232.00
<input checked="" type="checkbox"/> 16C 30' cord in lieu of 20' (per float).....	\$5.00	<input type="checkbox"/> 36E EZconnex® 3-Port, 50', w/10' floats (2) /pipe clamp, sealing plug *.....	\$268.00
<input type="checkbox"/> 16D 40' cord in lieu of 20' (per float).....	\$15.00	<input type="checkbox"/> 36G EZconnex® 3-Port, 25', w/20' floats (2) /pipe clamp, sealing plug *.....	\$245.00
<input type="checkbox"/> 17C Sensor Float* / internally weighted ▲ (per float).....	\$9.00	<input type="checkbox"/> 36H EZconnex® 3-Port, 50', w/20' floats (2) /pipe clamp, sealing plug *.....	\$281.00
<input type="checkbox"/> 17D Sensor Float* / externally weighted ▲ (per float).....	\$11.00		
<input type="checkbox"/> 17G MilliAmpMaster™/ pipe clamp ● (per float).....	\$0.00		
<input type="checkbox"/> 17H MilliAmpMaster™/ externally weighted ● (per float).....	\$7.00		
<input type="checkbox"/> 17J Sensor Float* / pipe clamp ▲ (per float).....	\$4.00		

● Mechanically-activated ▲ Mercury-activated
 * EZconnex® mechanically-activated, narrow angle float switches with quick release connections.

TECHNICAL SPECS

- Dual Input Alarm Channels: (1) 12VAC/VDC to 120VAC/VDC, opto-isolation, (1) Dry Contact input, dry contact triggers call out only - no siren or strobe activity (silent alarm)
- Backup Battery: External 6DVC Sealed Lead, 1.3 AH Re-chargeable
- Operating Temperature: -20 to 150 F
- Operating Humidity: 0-90% RH, non-condensing
- Alarm Light Bulb: Super bright LED cluster long-life
- Alarm Light Annunciator: 2.8kHz, 85dB
- Alarm Light State: Pulses LEDs and Annunciator at 3Hz when input #1 is in alarm
- Cellular Radio: CDMA Dual Band 1xRTT (CDMA2000) 800/1900
- Certifications: FCC Parts 15, 22, 24, RoHS compliant; IC: RSS-132 & 133
- Antenna: Integrated, on board
- Input Power: 120VAC +/-20% @ 0.5A max, 12 VDC or Solar options
- Enclosure: NEMA 4 equivalent rating for direct mounting indoors or outdoors
- Dimensions: 5"W round base x 5" H
- Weight: 1lb
- Protection: US Patent #7,228,129 and #7,778,633

WIRING DETAIL

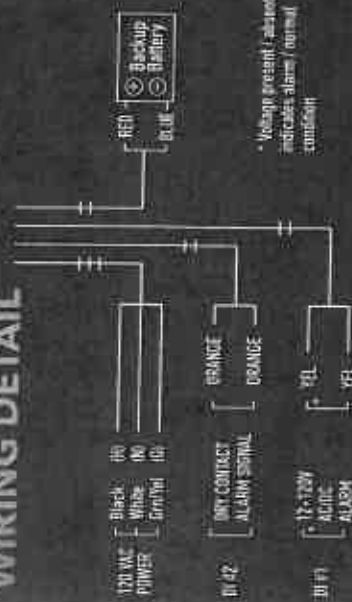

OmniSite
CELLULAR MONITORING SOLUTIONS

www.OmniSite.com
203 W. Morris St. Indianapolis, IN 46225
(317) 885-6330

OmniBeacon™

ALARM LIGHT

WITH CELLULAR TRANSMITTER AND SIREN

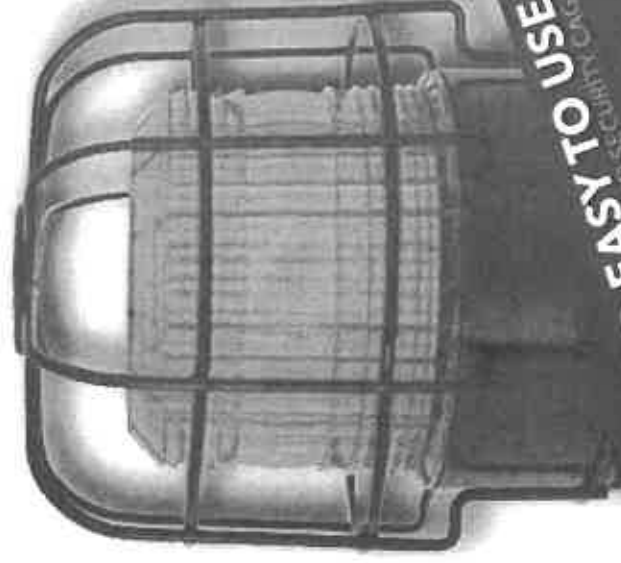

SIMPLE AND EASY TO USE!
AVAILABLE WITH SOLAR POWER AND 3G CELLULAR EDGE

GET INSTANT NOTIFICATIONS
OF MACHINERY MALFUNCTIONS



TEXT



EMAIL



VOICE

Ziad Qudwa Custom Exempt Slaughterhouse On-Site System

Operation and Maintenance Procedures

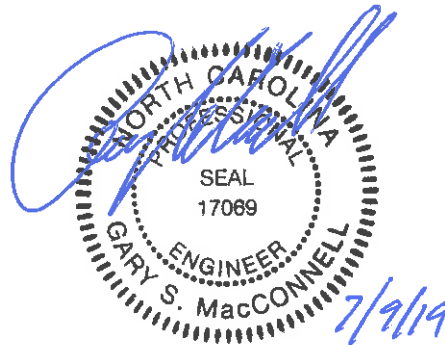

**MacConnell & Associates, P.C.
1101 Nowell, Road, Suite 118
Raleigh, North Carolina 27607**

**P.O. Box 129
Morrisville, North Carolina 27560**

**Phone: (919) 467-1239
Fax: (919) 319-6510**

Operation and Maintenance Procedures shall be as contained in the following Approvals:

Innovative Wastewater System No.: IWWS-2015-03-R2

Innovative Wastewater System No.: IWWS-2004-01

Operation and Maintenance Plan

System Background

The wastewater treatment and disposal system is designed to treat the generated slaughterhouse wastewater. The system will consist of one (1) septic tank with effluent filter, one (1) grease trap tank, one (1) flow equalization tank, two (2) Model 600 E-Z Treat recirculating media filter (treatment units), one (1) E-Z Treat recirculation tank, one (1) field dosing tank, an ultraviolet disinfection unit, initial and repair irrigation fields with sufficient drain lines, and all the necessary appurtenances. The septic tank will receive the wastewater by gravity flow as it leaves the building. Once the wastewater fills the septic tank, it will exit the septic tank by gravity through an effluent filter. The wastewater then enters the grease trap tank where the fats, oils, and grease are separated from the wastewater. Then the grease tank effluent enters the flow equalization tank where a preset equalized flow is pumped to the E-Z Treat recirculation tank. The E-Z Treat recirculation tank where it is pumped through the E-Z Treat treatment unit for advanced secondary treatment. The E-Z Treat treatment unit removes additional BOD, TSS, and FOG that were not removed in the septic tank, grease trap tank and effluent filters. The wastewater then flows by gravity into the E-Z Treat recirculation tank or is diverted to the field dosing tank by means of an effluent bypass valve. Wastewater flowing into the field dosing tank is treated by an ultraviolet disinfection unit prior to entering the tank. Each of these treatment units are described in additional detail below.

Septic, Grease Trap, Equalization, E-Z Treat Recirculation, and Field Dosing Tanks:

The proposed wastewater treatment system will provide both anaerobic treatment for BOD, nutrient and solids removal in the septic tank. This tank will be provided as specified on the construction drawings, or approved equal by Engineer. The tank shall be previously approved by the On-Site Water Protection Section. This tank shall provide greater than 2 days of detention time providing for adequate anaerobic treatment and solids removal from the wastewater. The septic tank will contain a Polylok, or approved equal effluent filters to prevent solids from reaching the E-Z Treat recirculation tank.

The grease trap tank will be installed as shown on the construction drawings. The tank will remove the majority of the fats, oil, and grease (FOG) generated from the slaughter operation. The grease trap tank will contain a Polylok or approved equal effluent filter as shown on the construction drawings to prevent fats, oils, grease, and solids from reaching the E-Z Treat recirculation tank.

The flow equalization tank will be as shown on the construction drawings, or approved equal by Engineer. The equalization tank will be sufficient for peak flows and maximum daily flows generated from upstream. A preset dosage will be dosed by an equalization pump to the E-Z Treat recirculation tank.

The E-Z Treat recirculation tank will be provided as specified on the construction drawings, or approved equal by Engineer. The equalization tank will pump wastewater into the E-Z Treat recirculation tank. Wastewater will then be pumped from the E-Z recirculation tank onto the E-Z Treat treatment units, and the E-Z Treat treatment unit effluent will flow by gravity into the E-Z Treat recirculation tank or the field dosing tank. The field dosing tank shall be provided as

specified on the construction drawings, or approved equal by Engineer. The effluent from the field dosing tank will be pumped to the disposal field.

The flow equalization tank, E-Z Treat recirculation and field dosing tanks will be connected to audible and visible high water alarms. These alarms will alert the operator when too much wastewater has accumulated in the tanks so that he may turn on the pumps to empty the tank. The property is served by a public water system. Thus, water will likely be used during a power failure. A portable generator shall be provided by the business owner. If anytime, the alarms become audible and visible, the owner/manager shall stop the water usage from the slaughterhouse until the system issue the identified and resolved to normal operating functions.

Pumps:

There are three pumps within the wastewater treatment system. One (1) flow equalization pump will be a Myers ME 45 ½ hp pump, One (1) E-Z Treat treatment unit recirculation pump will be a Sta-Rite ½ hp pump (Catalog Number STEP 30). One(1) field dosing pump will be provided as specified on the construction drawings, or equivalent as approved by the engineer. All pumps will be connected to control panels. Pump efficiency shall be monitored by recording the amperage supplied to the pump. A sudden decrease in efficiency will indicate that the pump must be replaced. Pump replacement can be accomplished by disconnecting pumps from the power supply and unscrewing them from the attached piping.

E-Z Treat Treatment Unit(s):

The Model 600 E-Z Treat treatment unit(s) will be used to provide additional treatment to the septic/grease tank effluent as well as removing suspended solids not removed by the septic/grease tank. The treatment unit will be housed in the container provided by E-Z Treat. The E-Z Treat treatment unit will be dosed by a Sta-Rite pump (Catalog Number STEP 30, 1/2hp) with a distribution system placed above the styrene media which will discharge onto the media. The underdrain system will transport the E-Z Treat treatment unit effluent back into the recirculation or field dosing tank.

Ultraviolet Disinfection Unit:

The ultraviolet disinfection unit will be used to treat the E-Z Treat treatment unit effluent before it reaches the field dosing tank. The ultraviolet disinfection unit shall be E-Z Treat (Model E-Z UV 101) or approved equal by engineer..

Crop Maintenance and Management:

The drain area should remain as original condition and be planted with a fescue, rye, or Bermuda grass as needed in compacted areas. The wastewater applied to the trees or grass (if needed) will provide ample moisture and nutrients to promote plant growth. All dead trees if applicable, newly grown vegetation and newly grown trees less than 1 inch shall be removed yearly. Heavy traffic should be restricted from this area.

System Operation

The secondary wastewater treatment system is designed to dose the E-Z Treat treatment unit every 14 minutes to 20 minutes with 34 gallons of septic tank effluent. If less than 34 gallons of wastewater is available, the low level signal will inactivate the pump. The control panel will activate the field dosing pump to the pressure manifold. Flow to the pressure manifold is designed for a maximum dose as shown on the construction drawings. The volume dosed is controlled by a demand dose panel on a preset dosage volume. The pump will de-energize if the low water level “pump off” float is activated.

If the high water level “alarm” float switch is activated, the system will energize the audible and flashing alarm fixtures. Once energized, the flashing and audible alarm units may only reset manually. If the alarm light begins flashing after being reset, it means that either there is a clog in the system or the pump has failed. This may be corrected by simply resetting the system. If this doesn’t energize the pump, the wet well will have to be opened and the pump removed to check for deficiencies or an object that may be clogging the system. If there are no obvious flaws on the pump itself and no objects inside the pump tank, restore the pump and try resetting it again. If the pump still does not work, contact the pump manufacturer.

The E-Z Treat treatment unit(s) shall include, but not be limited to an “auto/manual” system control switch, stop/start switch, non-resettable elapsed time recorder for each pump, and individual pump run lights. Both pump control panels shall contain NEMA 4X enclosures. All supporting control units, if not housed within the pump control panels, shall be in a separate NEMA 4X enclosure.

No heavy traffic shall be driven over the treatment units or disposal fields at any time. This access is restricted in order to protect the health and safety of people. It is important that the trench line area in non-wooded or compacted areas be seeded with grasses or trees to establish vegetation. The vegetation will absorb any nutrients remaining in the treated wastewater, and the treated wastewater will promote the growth of the vegetation. The vegetation will need to be maintained so that it does not interfere with the performance of the pressure manifold system.

System Maintenance

To ensure a smooth operating system, regular maintenance shall be performed on each treatment unit. The maintenance for each unit is detailed on the plans and is displayed in the following table.

Further system maintenance information shall refer to the manufacturer’s literatures.

Operation and Maintenance Tasks

Unit	Frequency	Task
Septic Tank: damage	3 – 6 months	Check for solids accumulation, blockages, or baffle damages, in/exfiltration, pump septage.
Septic/Pump Tanks: solids and scum	12 months	Pump out accumulated solids if necessary, remove scum layer.
Grease Trap Tank	1 month	Check for accumulated fats, grease, and oils. Pump out as needed.
Grease Trap Tank	12 month	Pump out and clean tank as the peak season comes close.
Effluent Filter: Testing	3 – 6 weeks	Check and clean as needed.
Effluent Filter: Replacement	12 months	Replace each time septic tank is pumped.
E-Z Treat Treatment Unit	monthly	Inspect control/alarm panel, recirculation tank, and E-Z Treat treatment unit (filter pod).
Ultraviolet Disinfection	weekly	Wipe (clean) UV lamp, check intensity and replace lamp when required.
Pump Tanks: Pumps and Controls	weekly	Check pumps, controls, alarms, elapsed time meters.
Pump Tanks: Solids and Potential Leaks	3 – 6 months	Check for solids accumulation, or infiltration and exfiltration.
Pump Tanks: Scum Accumulation	12 months	Remove scum layer when septic tank is pumped.
Trench Field: Vegetation	2 – 4 weeks	Weed Eat vegetative cover to a minimum height of 4 inches if applicable to ensure vegetation does not interfere with the system operation.
Pressure Manifold System: Piping and Distribution Equipment	3 – 6 months	Check for leaks in force mains, odors, ponding, and erosion to ensure runoff does not occur in disposal area.
Pumps, Distribution Piping, and Alarm System	monthly	Check flow meter readout and compare to recorded flows, check pumps for leaks.
Control Panel and Pump Efficiency	6 – 12 months	Check amp readout and compare to manufacturers instructions.

*Tanks should not be pumped during wet conditions.



Re-Circulating Synthetic Filter

**Operation
and Maintenance
Manual**

NSF

Models bearing the NSF mark are certified Class I
to one or more of the following standards:

NSF/ANSI 40
NSF/ANSI 245
NSF/ANSI 350

©2017 E-Z Treat 2-2017

TABLE OF CONTENTS

1.0	General Instructions	1
2.0	Basic Operation and Maintenance Requirements	2
2.1	Septic Tank	2
2.2	Re-Circulation Tank	3
2.3	Control Panel/Pumps/Alarms	3
2.4	E-Z Treat Re-circulating Synthetic Filter	4
2.5	Cleaning the Filter Media	5
2.6	Replacement of Media Mattress	6
3.0	Attention System Owner and Users	7

1.0 General Instructions

E-Z Treat Company requires regular life time inspection and lifetime maintenance of the E-Z Treat Re-circulating Synthetic Filter, as a condition of purchase and ongoing operational compliance. The inspection and maintenance interval should be no less than annually. For NSF listed systems or per applicable state regulatory requirements, the inspection and service interval shall be a minimum of every 6 months for the first two years and at a frequency per state regulations thereafter. The mandatory service contract will include a performance based system inspection. The service provider must be trained and certified by E-Z Treat Company or authorized representative.

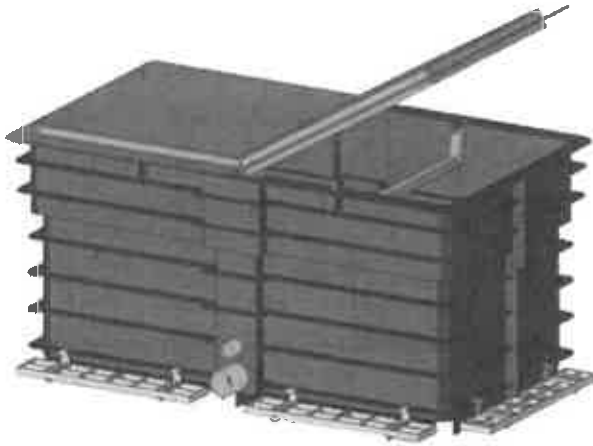

All inspection and maintenance reports must be forwarded, along with any additional documentation, to E-Z Treat Company, the local authorized E-Z Treat Dealer, and all required or designated regulatory agencies.

This manual contains a list of the routine maintenance procedures that are required by E-Z Treat Company. Failure to perform the required system maintenance could reduce the desired performance of the system and will void the warranty on the E-Z Treat Re-circulating Synthetic Filter system.

The E-Z Treat Re-circulating Synthetic Filter system should be inspected by an authorized service provider at start-up and for all inspections thereafter.

E-Z Treat Re-Circulating Synthetic Filter Pods

Model 600

Model 1200

Pods can be configured in multiples for higher flow systems.

2.0 Basic Operation and Maintenance Requirements

2.1 Septic Tank

The septic and re-circulation tank shall be inspected annually to ensure they are operating properly. Remove the access covers over the tank openings to perform the inspection.

1. Verify the lid and riser assemblies are watertight. Check for any damaged, water weeping marks, holes or cracks. The system must remain watertight to perform properly.
2. Remove, clean and replace the outlet effluent filter in accordance with the instructions provided by the effluent filter manufacturer.
3. Inspect the liquid level in the septic tank, it should be level with the bottom of the outlet pipe.
4. Inspect the effluent and scum layers in the septic tank. Look for oil or any other contaminants that are not normal.
5. Verify the tank has received its scheduled pumping and cleaning. Check the solids layer in each of the tanks. If the solids layer is excessive have the tank pumped.

2.2 Re-Circulation Tank

The re-circulation tank shall be inspected annually to ensure it is operating properly. Remove the access covers over the tank openings to perform the inspection.

Verify that the lid and riser assemblies are watertight. Check for any damaged, water weeping marks, holes or cracks, the system must remain watertight to perform properly.

1. Inspect the liquid level in the re-circulation tank, it should be level with the bottom of the outlet pipe.
2. At initial system start-up, remove the end caps from the spray manifold. Operate the re-circulation pump by turning the pump control to the "HAND-ON" position. Let the pump run for **one minute** then turn the pump control to the "OFF" position repeat this procedure three times to flush any construction debris such as dirt or pipe shavings from the spray manifold. Replace the end caps **hand tight**—do not use wrenches or pliers. Re-set the pump control selector switch to the "AUTO" position.
3. Inspect the float by-pass valve. Manually start the re-circulation pump and observe the float ball valve, the ball should drop as the liquid in the re-circulation tank drops the effluent returning from the E-Z Treat pod should flow back into the re-circulation tank and should not flow out the discharge pipe.
4. Verify that all the re-circulation pump floats are in good condition, properly secured to the float bracket and are able to move freely within the re-circulation tank.
5. Observe the system as it re-circulates. Visually verify all flows through the system.

2.3 Control Panel/Pumps/Alarms

1. Check the functions of the E-Z Treat Re-circulating Synthetic Filter control panel.

Control: Main Control "ON/OFF" switch
Function: Turns power ON or OFF

Control: System Setting Switch "MANUAL ON" and "AUTO ON"
Function: "MANUAL ON" overrides all float switches and time clock switches
 "AUTO ON" allows for normal operations dictated by the time clock and float switches.

Control: Timer "MINUTES ON" and "MINUTES OFF"
Function: Controls run time of re-circulation pump i.e. GPD re-circulated through media.

Control: High and Low Water Alarm "ALARM ON", "ALARM AUTO" and "ALARM SILENCE"
Function: "ALARM ON" will manually turn on the audio/visual alarms.
 "ALARM AUTO" is the normal operational setting and "ALARM SILENCE" turns off the alarms.

Check re-circulation pump. Place the system in the manual mode by turning the re-circulation pump switch to "ON". The re-circulation pump should begin to supply effluent to the spray nozzles in the treatment pod.

2. Check the voltage and motor amp draw and record the readings. If the readings are beyond the limits of the NEC recommendations, have an electrician check the main service line feeding the system control panel.

3. Place the system in the normal operating mode by turning the re-circulation pump switch to "AUTO". Verify the timer ON/OFF settings are the same as set at system start-up. Record those timer settings in the system log.

4. Verify the accuracy of the system ON/OFF Timer. To accomplish this use a stop watch and verify the length of time the re-circulation pump is OFF then verify the time the re-circulation pump is ON, those times should match the ON/OFF Timer settings in the control panel.

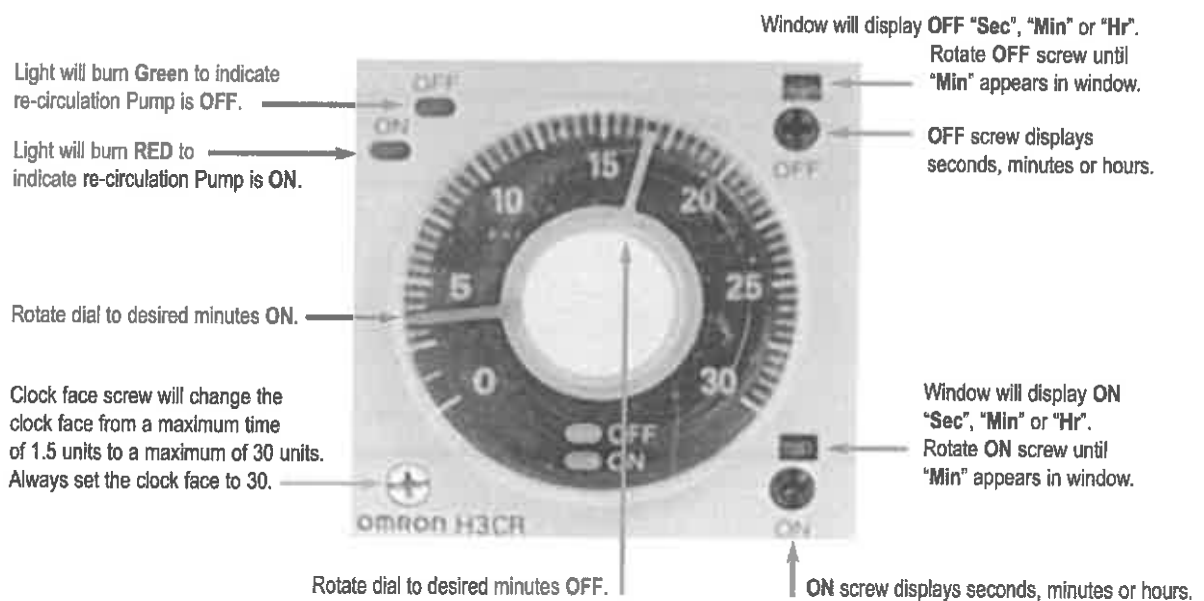

5. Confirm the operation of the visual and audible "HIGH" and "LOW" water alarms. The control has an alarm switch clearly marked Alarm "ON", Alarm "AUTO" and Alarm "SILENCE" Place the alarm switch in the "ON" position, you will hear a loud buzzer and see a red flashing light. Move the switch to the Alarm "SILENCE" position the red light and buzzer will go dormant.
6. Once the alarms have been triggered return all settings to their original position of Alarm "AUTO" (If applicable, verify the operation of the telemetry unit by checking the alarm notations on the website.)
7. Verify the floats are operational by manually raising and lowering the floats to simulate the systems normal operation. Verify proper operation of "High Level Float" by lifting the float while the system T is in the "OFF" time mode, the re-circulation pump should turn on over riding the "OFF" timer, the Visual and Audible alarms should activate. Return the float to its normal position the re-circulation pump will turn off. Reset the alarms and manually lower the "Low Water Float" with the timer in the "ON" mode, the re-circulation pump will turn off and the visual/audible alarms will activate. Return the float to the normal position and the re-circulation pump will run. Reset the alarms.
8. Properly re-install and secure all tank accesses!

2.4 E-Z Treat Re-circulating Synthetic Filter

The E-Z Treat Re-circulating Synthetic Filter should be inspected to ensure it is operating properly. Remove the pod cover to perform this inspection. Each E-Z Treat system should be installed with a sample box located on the final discharge side of the treatment system, this sample box is ideal for grab samples. If the installer failed to install a sample box grab samples can be taken from the pump discharge tank. Many state regulations include instructions for taking grab samples those rules and procedures supersede E-Z Treat.

1. Take a grab sample of the effluent check for:
 - a. Odor, the effluent may have an earthy or musty smell there should be no strong or offensive odors present.
 - b. Color, the effluent should be clear and absent of any color.
 - c. Solids, there should be no visible suspended solids
 - d. Solids, let sample set for 15 minutes, there should be no visible settling of solids.
 - e. Test the pH, it should measure 6.9 to 7.5
2. Observe the spray distribution nozzles during operation. If a nozzle appears to be clogged or if the spray pattern is not uniform, remove the nozzle and clean the nozzle using a pipe stem cleaning brush.
3. Record the pressure reading on the distribution manifold gauge. Compare that pressure to the pressure recorded at the previous inspection. The pressure should read 18 to 25 PSI.
 - a. Verify the pressure gauge on the spray distribution manifold is performing properly.
 - b. Verify the flow rate at the spray nozzles (it should be 1.75 to 2 GPM).
 - c. Verify the re-circulation pump is the same make and model pump that was specified for the original installation.

If there is odor, color or solids clean the media.

If the pH is below 6.9 reduce the re-circulation rate by increasing to "OFF" time on the Time Clock Control. Recheck the pH in 90 days.

- d. Verify the re-circulation pump is performing in accordance to the pump manufacturers' specifications including amp draw and flows at specific pressures.
 - e. If the pressure is above the prior recording or above the start up setting, open the ends of the distribution manifold lines, manually start the re-circulation pump and allow it to run for 5 minutes. This should flush out the spray distribution lines. If the pressure remains too high, after cleaning the spray nozzles and flushing the spray distribution lines, adjust the pressure to the desired PSI using the ball valve on the main spray distribution supply line.
 - f. If the pressure/flow is too low check for cracks, breaks or obstructions in the main distribution supply line.
4. Verify the treatment pod is properly draining by looking down the pod side wall vents, there should be no standing water, the bottom of the pod should be visible.
 5. Visually inspect the surface of the treatment media for:
 - a. Holes, tears, loose seams
 - b. Foreign material
 - c. Black color on media (media should have light brown tint)
 - d. Excessive bio mat growth
 - e. Ponding
 - f. Clumping of the media.
- Note:** If any of these conditions exist the media needs to be cleaned.

2.5 Cleaning the Filter Media

Depending upon influent strength and influent volumes, excessive biological growth can accumulate inside and on the surface of the media filter after 7 to 10 years of use.

Cleaning of the media is a very simple and easy 10-step process:

- Step 1:** Turn off power to any discharge pump.
- Step 2:** Remove the treatment pod cover and remove the spray distribution manifold.
- Step 3:** Connect wash down hose to the main spray distribution supply line.
- Step 4:** Manually turn on the re-circulation pump.
- Step 5:** Pressure wash the surface of the media mattress, the wash water will drain into the re-circulation tank and will be re-used as wash water.
- Step 6:** Roll the media mattress and wash the sides and bottom of the media mattress.
- Step 7:** After the media is completely cleaned properly place the media mattress in the treatment pod.
- Step 8:** Re-install the spray distribution manifold.
- Step 9:** Pump out and clean the re-circulation tank removing all the wash down water. Pump out the septic tank.
- Step 10:** Turn on power to discharge system and return the treatment system from "Manual" mode to "Automatic" mode.

2.6 Replacement of Media Mattress

If the filter media is exposed to excessive concentrations of petroleum products, paints, glues, waxes etc. it will become necessary to replace the media. The replacement process is a very fast and simple. Removing the media mattress should be performed by service agents that are trained and certified by E-Z Treat Company.

- Step 1:** Turn off power to re-circulation pump, discharge pump and controls.
- Step 2:** Pump the septic tank and re-circulation tank to assure continued service by residence during the replacement.
- Step 3:** Remove the spray distribution manifold.
- Step 4:** Lift the media mattress out of the filter pod.
- Step 5:** Place the mattress into the fiberglass transport container provided by E-Z Treat Company. The container is easily hauled in a pickup truck or on a light duty trailer.
- Step 6:** Install new filter media and replace distribution manifold.
- Step 7:** Reset all system control settings to "AUTO" and turn the main power switch to the "ON" position.

Once the mattress is returned to E-Z Treat Company, the styrene material will be sent to the nearest recycling facility for processing. Alternatively, the service provider can transport the mattress to the nearest styrene recycling facility for processing.

3.0 Attention System Owner and Users

CAUTION

Do Not open or enter any system components for any reason. If a problem exists or you have questions about your system, call your authorized service provider.

Once the E-Z Treat Re-circulating Synthetic Filter system is installed, a post-construction conference is recommended. This is an opportunity to familiarize the owner with the system. No attempt should be made to adjust any component of this system except by a Certified Operator.

The E-Z Treat Re-circulating Synthetic Filter system allows the homeowner to receive a high quality, reliable and economical wastewater system that protects the environment. As with any onsite wastewater treatment system, the homeowner should be familiar with basic guidelines which help the system achieve repetitive, reliable performance. Please do not hesitate to contact your certified operator or E-Z Treat Company with any questions, concerns or comments about your E-Z Treat Re-circulating Synthetic Filter system.

Users of the System—Remember!

To assure proper performance of your E-Z Treat Re-circulating Synthetic Filter, you should avoid disposing of the following products into your septic tank:

- Oil & Grease (kitchen waste)
- Water Softener backwash
- Wax & resins
- Petroleum Products
- Paint & Paint Solvents
- Pesticides
- Condoms & sanitary napkins
- Toxic substances (Liquid Plumber, Drano, etc.)
- Non-Biodegradable products (cigarette butts, antibacterial wipes, etc.)
- Any kind of septic tank additive (Rid-X, etc.)

Owners of the System—Remember!

- Keep heavy loads and traffic off of your onsite system components and drainfield.
- Never drive cars or trucks within 10 feet of any system access lids.
- Landscaping or future building projects should be planned with the drainfield and drainfield repair area in mind.
- Do not shovel or blow snow on top of your onsite wastewater system. This will temporarily limit access to your system and could overload and damage the system.
- Make sure drainage from the house or around the property is carried away from your onsite system.
- DO NOT OPEN OR ENTER ANY OF THE TREATMENT SYSTEM TANKS. SEPTIC GASSES CAN BE TOXIC, CAUSING SERIOUS INJURY OR DEATH!



PO Box 176
Haymarket, Virginia 20168

T 703.753.4770

F 571.248.8837

eztreat.net

E-Z Treat Company, Inc.
Residential Applications
2-Year Limited Warranty
PO Box 176
Haymarket, Virginia 20168

1. Preamble

E-Z Treat Company (herein referred to as "E-Z Treat") is known for researching, designing, and producing innovative products of high quality for the onsite wastewater industry. We are proud to stand behind our **E-Z Treat Sand/Media Filter**.

For the purpose of this warranty, "Service Provider" means the legal Certified Operator of the system. This Service Provider shall be currently listed on State and Local records as meeting any applicable requirements required by law and/or Rule. Also, for purposes of this document, "Installer" means the person or company that has installed the system, and "Owner" means the person that has purchased the system or purchased the property serviced by the system.

2. Nature of Warranty

E-Z Treat warrants to the Owner that the **E-Z Treat Sand/Media Filter** will function within prescribed limits for a period of two years from the date of purchase.

E-Z Treat also warrants certain components of the system against materials, workmanship and manufacturing defects for a period of two (2) years from the date of installation.

This warranty is in addition to the legal warranties and Owner's rights in accordance to applicable law.

The conventional warranty of E-Z Treat is expressly limited to the text in this certificate. Owner is responsible for reasonable care and communication with the Certified Operator.

3. Obtaining Warranty Service

To make a claim on this warranty, the Owner should put the request in writing and mail or deliver to an authorized E-Z Treat Certified Operator. The claim will be processed and sent to E-Z Treat headquarters.

Any claim must be received no later than two year from the date of purchase of the **E-Z Treat Sand/Media Filter**.

On receipt of this claim, E-Z Treat or their authorized representative will examine the situation at the site and take corrective action where the terms of the warranty apply.

4. Exclusions and Limitations

E-Z Treat Company Warranty only extends to replacement parts the labor for installing those parts is not part of this warranty. Any electrical device or electrical component is excluded from this warranty including replacement parts and labor.

E-Z Treat is not liable for the dispersal portion of the onsite wastewater system. This portion of the system is evaluated, designed and constructed in accordance with local regulations and is wholly separate from the performance of the **E-Z Treat Sand/Media Filter**.

The following conditions are also excluded from the E-Z Treat warranty:

- This warranty does not cover cosmetic damage or damage due to acts of Nature, misuse, abuse, modification, incorrect design or incorrect installation.
- The warranty is void if any modifications or repairs are made to the system by anyone other than an E-Z Treat approved agent.
- Failure of the Owner to comply with the requirements set forth in the Owner's Manual.
- The warranty is void if any system components are repaired or replaced by parts not supplied or approved by E-Z Treat.
- This warranty is not applicable to systems not receiving domestic, residential sewage.
- The warranty is void if it is found that the Owner has failed to notify E-Z Treat of any change in the use of the property from its original design.

5. **Indemnities and Damages**

E-Z Treat's liability and obligations under this warranty for corrective measures or means of correction shall be limited to the replacement of the **E-Z Treat Sand/Media Filter Components**.

6. **Limitations of Damages**

E-Z Treat is not liable for any damages sustained by the Owner. E-Z Treat's compensation and indemnification obligations are limited to the provisions of this warranty

7. **Transfer of Ownership**

In the event of transfer of ownership within two years of use, this warranty shall transfer to the new Owner for the remainder of the period under the following conditions:

- a. The New Owner has a Certified Operator under contract.
- b. An Inspection of the **E-Z Treat Sand/Media** shall be conducted prior to transfer. Upon a satisfactory inspection, the Owner shall obtain a written report from the Certified Operator

8. **Inspection**

The Owner shall allow the Certified Operator access to the property and system components for purposes of necessary monitoring and service.

If the Owner submits a request of claim under this warranty and it is found to be in error after inspection, a charge for direct expenses will be billed to the customer to cover the cost of the inspection.

9. **Priorities of the Warranty**

This warranty supersedes any contract or understanding, verbal or written, entered into between the Owner, Certified Operator, Installer, or Representative of E-Z Treat.

SYSTEM MAINTENANCE

It is recommended that the system receive routine maintenance, at least annually. Please check your State and local regulations for required frequency of inspection.

ROUTINE AND PREVENTATIVE MAINTENANCE

- 1) Remove the filter and clean, or install a clean filter element.
- 2) Open the field flush valve and flush the field for 5-10 minutes by activating the pump in "manual" position. Close the flush valve (on systems with manual flush valves, close the field flush valve until design field pressure is reached).
- 3) With the pump in the "manual" position, check the pressure in the drip field by using a pressure gauge on the Schrader valve (located on the air vents), and by reading the pressure gauge located in the Headworks box. The pressure should be close to the same as shown on the initial installation records.
- 4) Remove the lids on the vacuum breaker and check for proper operation. If water is seen leaking from the top of the vacuum breaker, remove the cap of the vacuum breaker and check for debris.
- 5) Turn off the pump.
- 6) Periodically remove and clean the air vents, field flush and filter flush valves.
- 7) Visually check and report the condition of the drip field, including any noticeable wetness/variations.
- 8) Treatment and distribution tanks are to be inspected routinely and maintained when necessary in accordance with the manufacturer's recommendations/State regulations.
- 9) Record the date of inspection as well as readings from elapsed time meter, pump counter, peak counter, high-level counter, power fail counter and any other logs provided in system controls. Double check the settings of the control panel to be sure no one has tampered with them since the last inspection.
- 10) Reset the controller(s) for automatic operation before leaving.

HOME OWNERS GUIDE FOR CARE AND MAINTENANCE OF DRIP DISPERSAL FIELD

A drip system has been installed on your property for the dispersal of the effluent from your home.

The drip dispersal system consists of a series of ½" diameter drip tubing. It is designed to effectively disperse of the treated effluent using a combination of soil absorption and plant uptake. Your drip dispersal system will function for many years with only minimal maintenance being required, provided the following recommendations are followed:

- ❑ Establish landscaping immediately over subsurface system. This will stabilize the soil and allow for the grass to take up the water.
- ❑ Do not discharge sump pumps, footing drains or other sources of water to the system, except for the effluent discharge from your treatment system.
- ❑ Maintain all plumbing fixtures to prevent excess water from entering the dispersal system.
- ❑ Do not drive cars, trucks or other heavy equipment over the drip dispersal field. This can damage the drip components or the soil and cause the system to malfunction.
- ❑ Do not drive tent stakes, golf putting holes, croquet hoops, etc. into the dispersal field.
- ❑ Contact your service company if your alarm should sound. The pump chamber is sized to allow additional storage after the alarm sounds but you should refrain from excessive water usage (i.e., laundry) until the system has been checked.

Contact your service company if you notice any areas of excessive wetness in the field. There may be some initial wetness over the driplines following the initial installation. This should stop once the ground has settled and a vegetative cover is established



Re-Circulating Synthetic Filter

**UV
Installation and
Maintenance
Guide**

**Note: Maintenance Only
Installation is in Equipment Section**



Models bearing the NSF mark are certified Class I
to one or more of the following standards:

NSF/ANSI 40
NSF/ANSI 245
NSF/ANSI 350

©2017 E-Z Treat 2-2017

TABLE OF CONTENTS

1.0 UV Light System Installation	1
2.0 UV Light System Maintenance	2
Appendix 1: E-Z Treat UV System Configurations	3
Appendix 2: NSF Test Data	4

2.0 UV Light System Maintenance

The UV lamps quartz tubes (housing the lamps) must be cleaned at a minimum frequency of every 12 months.

Caution: Do not run UV lamps dry. Fill UV housing with water/effluent before turning on power.

Caution: Always turn off the power to the UV system before any maintenance is performed. Use extreme care when handling the fragile UV lamp assembly.

- Step 1:** Turn power "OFF" to the UV system!
- Step 2:** Unscrew the fitting holding the UV lamp and quartz sleeve.
- Step 3:** Lift the UV lamp assembly upward until it is clear of the housing.
- Step 4:** Using a clean, damp sponge or clean, soft cloth, wipe all residue from the quartz tube. Clean stubborn, dirty areas with a liquid glass cleaning product.
Caution: DO NOT scrape or use scouring pads.
This may scratch the quartz tube and alter the performance of the UV system.
- Step 5:** Visually inspect each quartz tube for cracks or breaks; replace any UV lamp assembly that is cracked, scratched, or broken.
- Step 6:** Re-insert the UV lamp assembly into the housing and tighten the fitting that holds the UV lamp and quartz sleeve. **Caution: (Hand-Tighten Only)**
DO NOT use wrenches, pliers, or other tools to tighten.
- Step 7:** Turn power "ON" to the UV system.



PO Box 176
Haymarket, Virginia 20168

T 703.753.4770

F 571.248.8837

eztreat.net

©2017 E-Z Treat 2-2017